



The Basic DISK II Pages

Speedadjustment **project**

In some very rare occasions the problem of bad speed-alignment might be related to one of two other problems:

Bad drivebelt

which might become difficult to repair and the best hint is searching for a fitting replacement of a stiff flat taperecorder-belt.

The evidence for this kind of trouble is if the drive has at the beginning within the first 2 to 3 minutes bad values of measurement displayed in the chart at locksmith speedtest and then adjusts to a kind of "average speed". That might be evidence that the drivebelt has become weak.

- or ageing of the speed-control board at the rear of the disk drive.

Due to age in very rare cases it might turn out to become required to "recap" the electrolytic capacitors of the speed-control board.

This can be verified by the following evidence: the problem remains to adjust the drivespeed to accurate speed and the speed remains within a wider variety than normal usual. normally speed can be adjusted to remain within a limitation of variety about 0,5 %. If it exceeds more than 0,5 % there is a chance that the electrolytic capacitors are getting dry by age and need replacement. In such case the ESR-measurement-values of the capacitors drop dramatically. There are also Tantalum capacitors at that speed-control board. They are normally not affected by this phenomenon. The affected capacitors are: C1, C5 and C6. In the picture at the bottom of the page the values of that capacitors are displayed.

In even more rare cases the foil capacitors might have drifted of the demanded values. That would be related to the capacitors C2 and C8.

Also possible trouble can be caused by a aged trimming-resistor VRJ which has a value of 50 kilo Ohm. But in most cases it's just usefull to turn off power and to move that resistor a few times 5 complete winding forward and 5 windings backward to clean the sliding contact inside of that resistor and then power-up again the computer and repeating the speed adjustment procedure. Another possible problem might be resistor R9 of it had to much heat exposure. this would be indicated by a slight change of the color of the resistor itself or the color of the PCB (PCB = Printed Circuit Board = circuit-board itself) below.

The drawings below also indicate some values of voltages and the points where they should be measured.

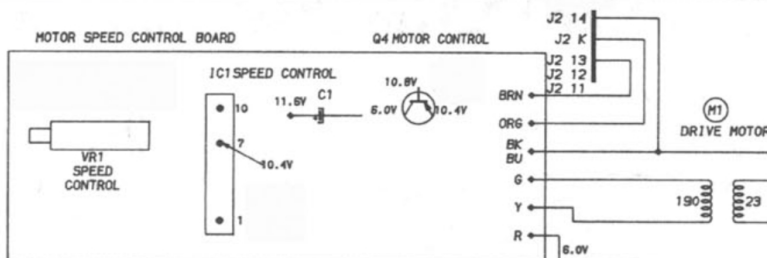
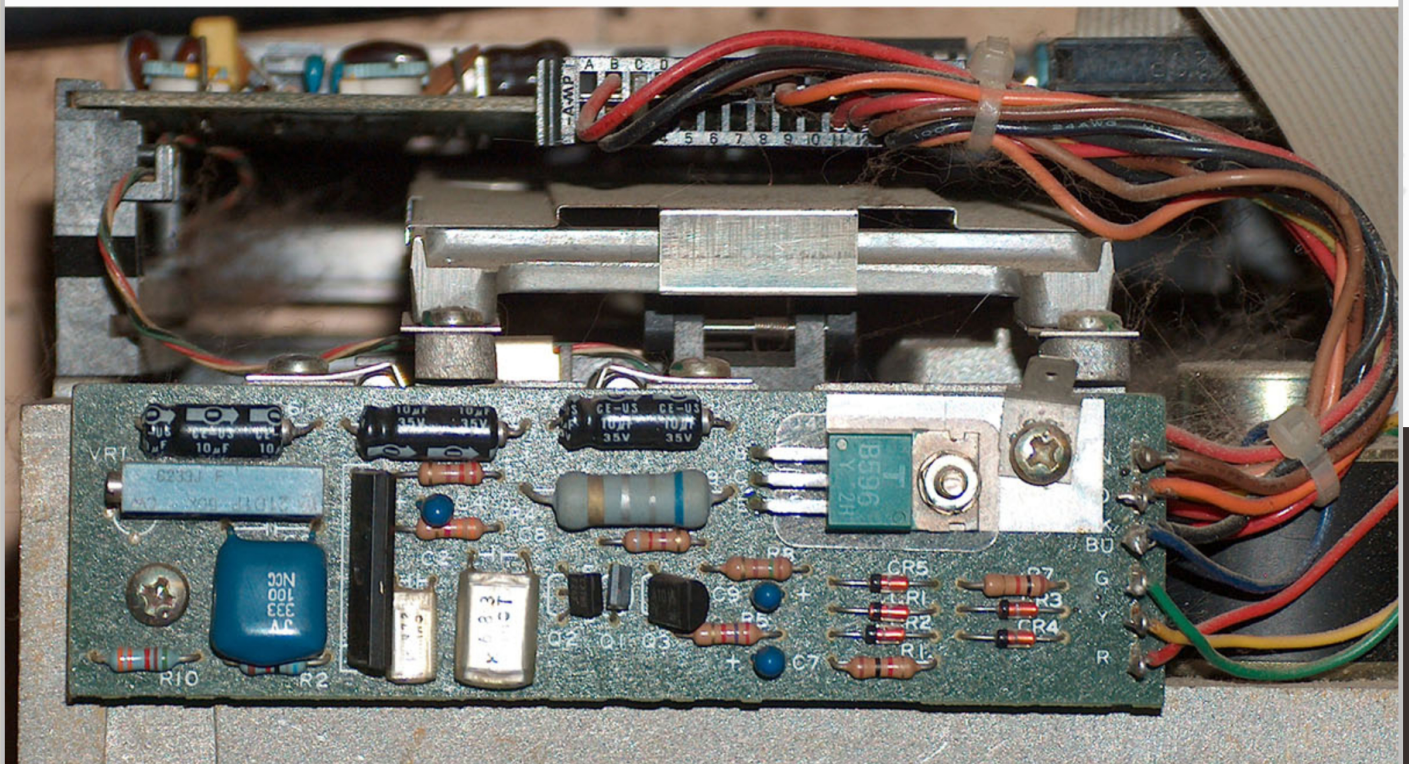

external wiring

10.4V
PIN 7

Q1
SWITCH

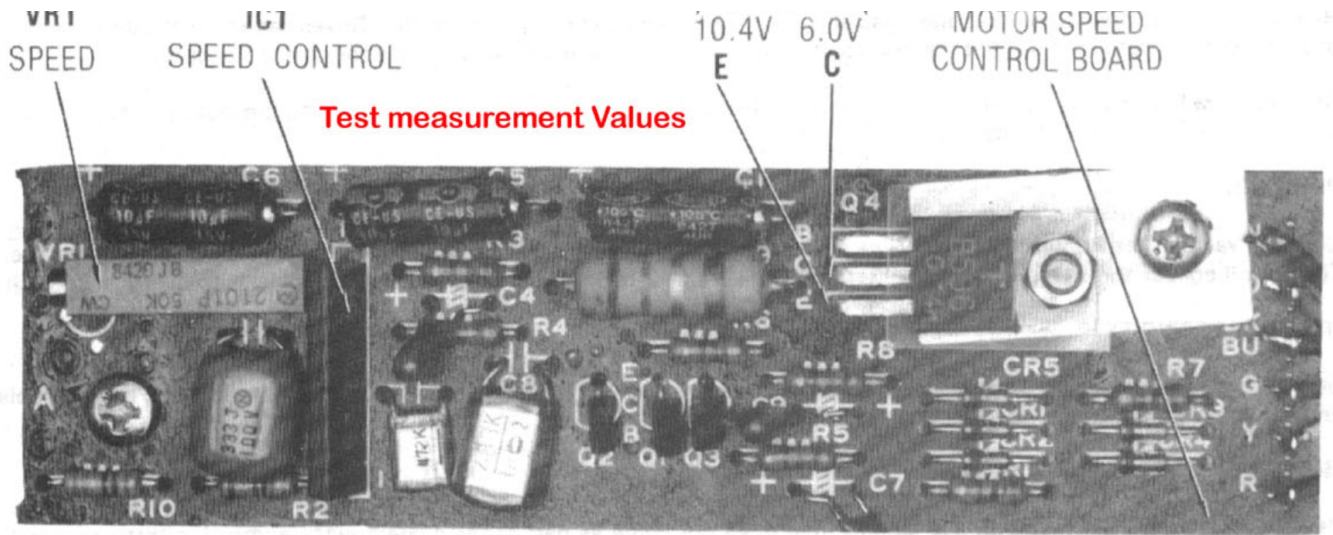

Circuitplan

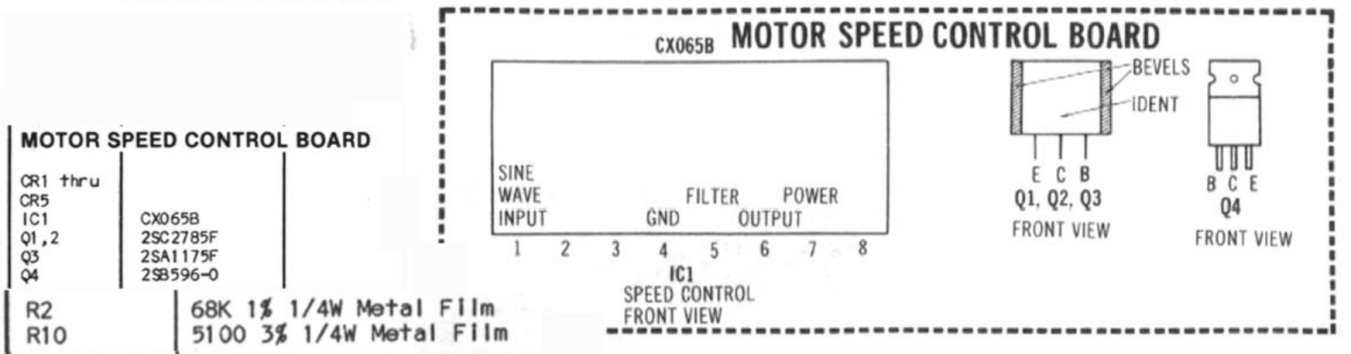
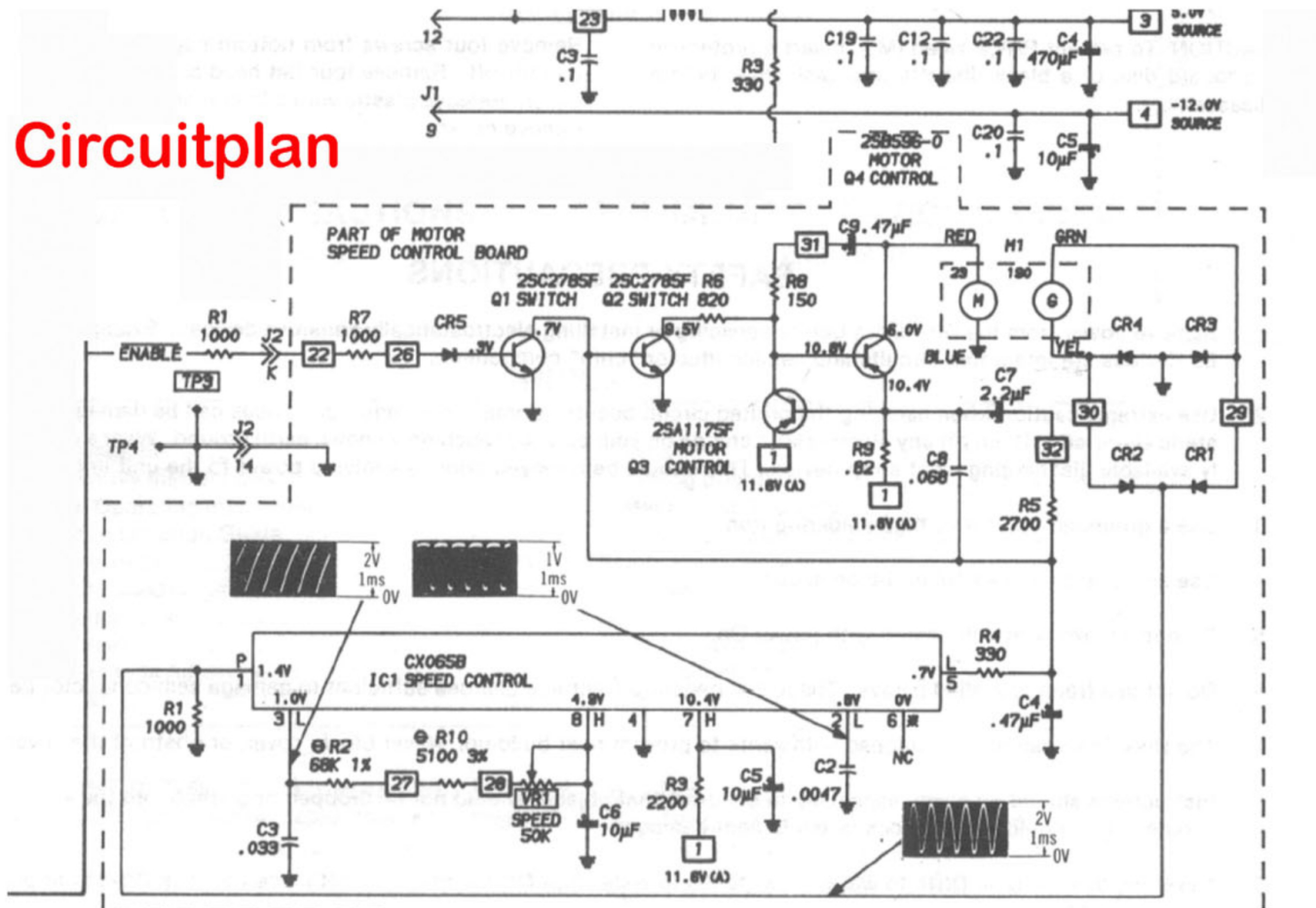

MOTOR SPEED CONTROL BOARD	
CR1 thru	
CR5	
IC1	CX065B
Q1, 2	2SC2785F
Q3	2SA1175F
Q4	2SB596-0
R2	68K 1% 1/4W Metal Film
R10	5100 3% 1/4W Metal Film

Part location Grid



LOCATION GUIDE

R1	D-12
R2	D-3
R3	B-6
R4	B-6
R5	D-10
R6	C-8
R7	C-14
R8	C-10
R9	B-8
R10	D-1
C1	A-8
C2	C-5
C3	C-3
C4	B-6
C5	A-5
C6	A-2
C7	E-10
C8	C-6
C9	C-10
CR1	C-12
CR2	D-12
CR3	C-14
CR4	D-14
CR5	C-12
IC1	C-4
Q1	C-8
Q2	C-7
Q3	C-9
Q4	B-10
VR1	B-2

Parts orientation

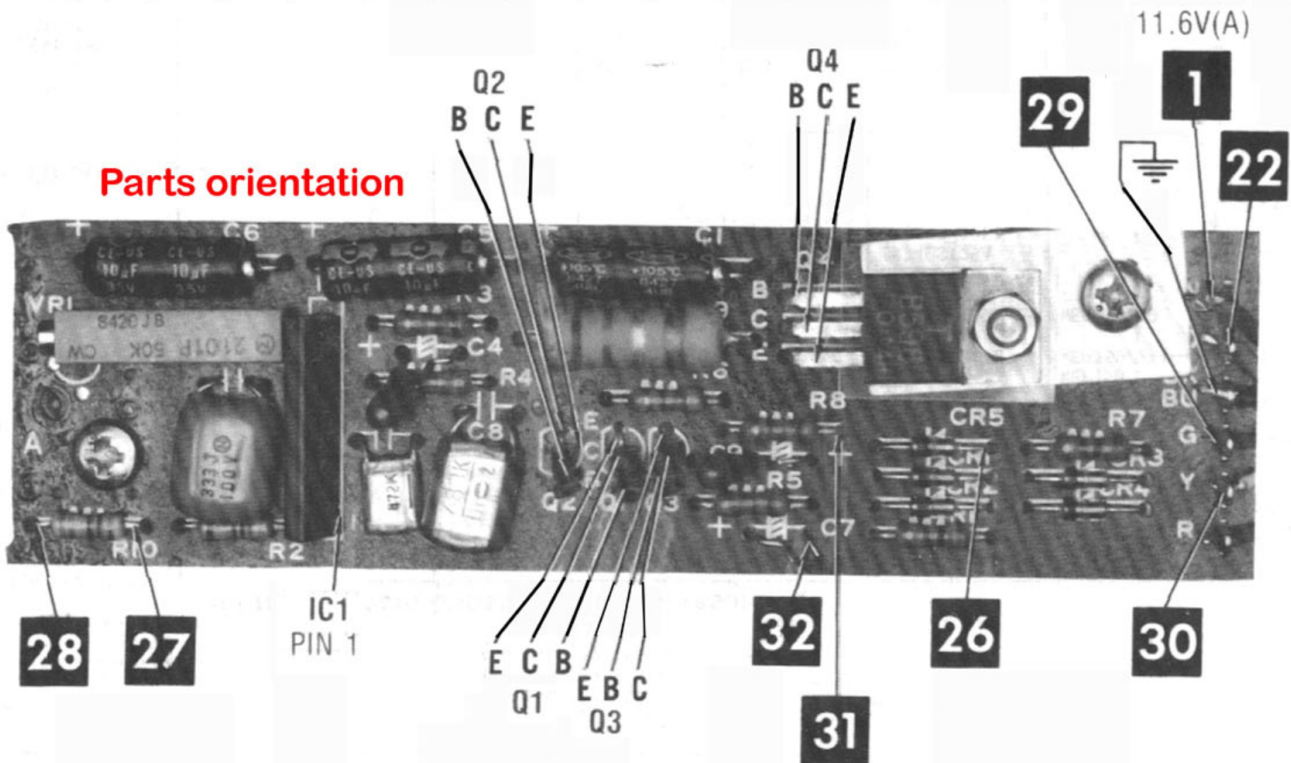

Component Values

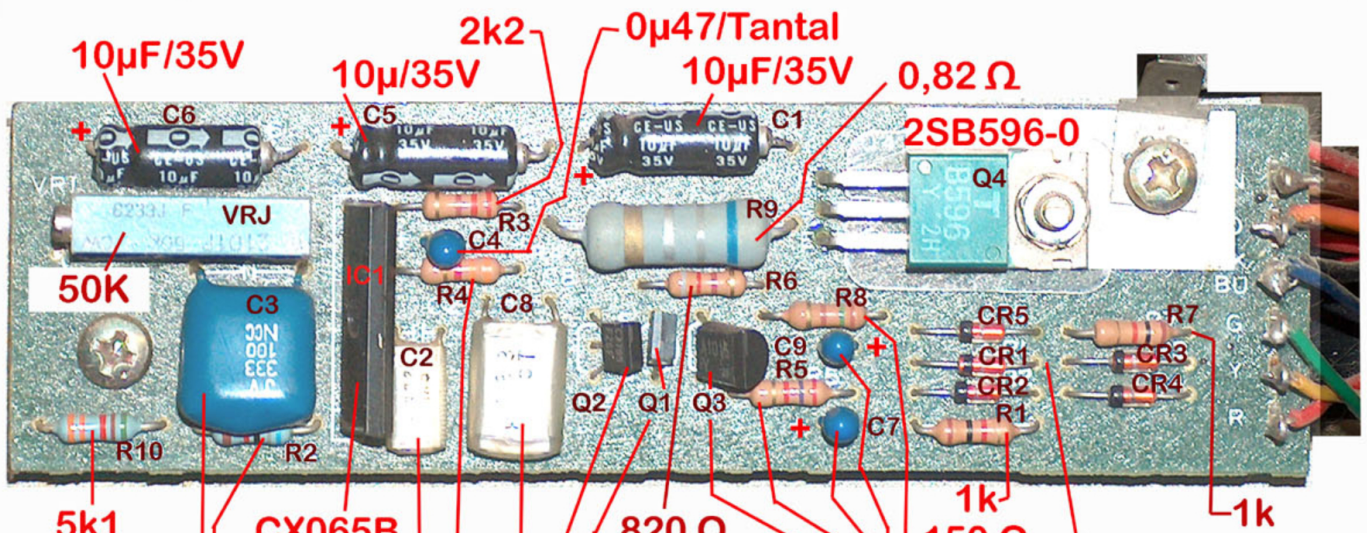

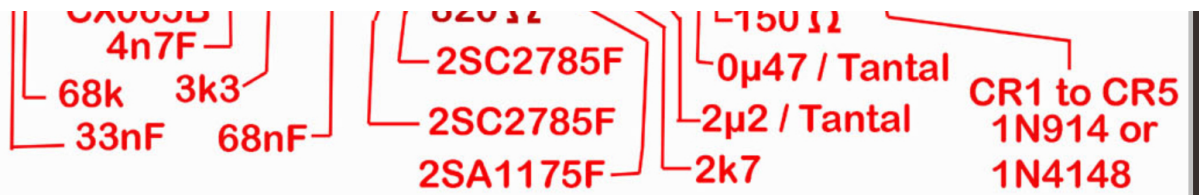

due to european laws and german court decision:

I hereby declare no responsibility to any "deep links" resulting from the links in this page. I have no influence to the pages linked hereby in this page and the contents in those pages. I therefor can't take any kind of responsibility to contents in the pages, where these links direct the readers browser to nor to the contents resulting from following up links from those pages. The reference to contents by this links is dependent ro the status of the date when the links have been set (April 2013) and it might occur that references and contents may change by the fact that domains may have been discontinued from their former owners. In such cases i can't take any kind of responsibility to the changed contents. this is specialy valid to banners, advertisements or merchandising links in the targeted pages.

[← Back to Indexpage](#)

[← page back](#)

[Page forward →](#)



published by SpeedyG since 2005 - nonprofit educational site