

NINJA V

User Manual

EDITION 2: OCT 2021



Register your NINJA V at my.atomos.com within twelve months of purchase to upgrade to a 3 year warranty.

Registering your product ensures you receive communication on all future updates

Contents

Warranty & Conditions	1	11. Edit	56
Introduction	2	SmartLog / Export XML	57
1. What's included	3	12. Connecting and Editing	59
2. What you also need	4	Connect to Input	59
Media (HDD/SSD)	4	NLE Support	59
HDMI Cables / Standard 1/4" or 3/8" mount	5	exFAT compatibility	59
3. Mounting disks in the Master Caddy II	6	Transferring files	59
4. Connecting and powering up	7	Importing / Import into Final Cut Pro	60
Powering the AtomX CAST	7	SmartLog with FCP	61
Power ON/Power OFF	8	ProRes RAW settings in Final Cut Pro	62
5. Ninja V connections	9	13. Technical Specifications	63
6. AtomX SSDmini, Master Caddy II and Screw Mounts	10		
Master Caddy II / SSDmini / Mounting options	11		
7. Using the Ninja V	12	Safety Instructions	
AtomOS10	12		
Best Practice	13	The Ninja V is designed to a high standard but there are some things you should be aware of to prolong the life of the unit and for your own safety	
- Date & Time / Format Media	13	Using the Ninja V safely	
- Unit Name / File naming	14	Although the Ninja V is very lightweight compared to all the devices it replaces, it is still a solid object that could cause injury if misused.	
- Screen Lock / AtomOS updates	15	<ul style="list-style-type: none">Always make sure that the Ninja V is mounted securely and is unable to fall onto anyone nearby. This is especially important when there are children present who might be tempted to pull on cables.Always ensure that cables that run to the Ninja V are clearly visible and do not present a trip hazard.Do not place on uneven or unstable surfaces.Do not insert anything but a Ninja V Master Caddy II or AtomX SSDmini in the drive slot on the rear of the Ninja V.Do not touch the Ninja V screen with sharp, metallic or abrasive objects.Do not expose to strong electrical or magnetic fields.Do not expose to liquids, rain or moisture.Do not dispose of the Ninja V in municipal waste and do not incinerate it, always follow local regulations for safe disposal.	
Main Screen - Home Screen	16		
Main Screen - Information Bar	17		
Main Screen - Monitoring Features	18		
Home Screen and Menu Functions	19		
Information Bar / Input	20		
Compatibility Mode / Remote	21		
Camera Control for ZCAM Series	22		
Camera Output	23		
Output	24		
Record	25		
- Compression	26		
HD Pulldown	27		
Timelapse	28		
Timecode	29		
Sync Config	31		
Sync Network / File	32		
Audio / Analogue Audio Input	33	Care of disk drives	
Media / Date / Battery	34	Spinning disks and SSDs are very sensitive to damage from static electricity. Please observe all the usual electrostatic discharge (ESD) precautions when handling them.	
Activation	35		
AtomX / Info / Attaching AtomX CAST	36		
8. Using the AtomX CAST	37	Please see the section on mechanical shock and vibration later in this manual for information about how to handle and care for your disk drives	
Using the AtomX CAST - Main Screen	38		
Monitor Functions	39	HDMI cables	
Input / Output	40	Please remember that almost all HDMI cables do not use locking connectors and will simply pull out if they are jerked or tripped over. Please ensure your cables make a secure connection and avoid flexing them excessively to maintain reliability.	
Graphical Overlays	41		
Picture in Picture / Switcher	42		
Audio	43		
9. Monitoring & Recording	44		
Setting up for recording / SmartControl	44		
Monitor Features	45		
Using Waveform Monitoring Tools	46		
Luma Waveform / RGB Waveform / Vectorscope	46		
Using Monitor Assist / Focus Assist / Zebra / False Color	47		
Blue Only / Zoom / Grid Lines / Focus Assist Settings	48		
LUTs	49		
Monitor - Using Standards – Native / Rec709 / HLG / PQ	50		
- Understanding HDR and Log	51		
Display / File Recovery	52		
10. Playback & Playback	53		
Playback Mode	53		
Playlists	54		
Video Format	55		

Safety Instructions

The Ninja V is designed to a high standard but there are some things you should be aware of to prolong the life of the unit and for your own safety

Using the Ninja V safely

Although the Ninja V is very lightweight compared to all the devices it replaces, it is still a solid object that could cause injury if misused.

- Always make sure that the Ninja V is mounted securely and is unable to fall onto anyone nearby. This is especially important when there are children present who might be tempted to pull on cables.
- Always ensure that cables that run to the Ninja V are clearly visible and do not present a trip hazard.
- Do not place on uneven or unstable surfaces.
- Do not insert anything but a Ninja V Master Caddy II or AtomX SSDmini in the drive slot on the rear of the Ninja V.
- Do not touch the Ninja V screen with sharp, metallic or abrasive objects.
- Do not expose to strong electrical or magnetic fields.
- Do not expose to liquids, rain or moisture.
- Do not dispose of the Ninja V in municipal waste and do not incinerate it, always follow local regulations for safe disposal.

Care of disk drives

Spinning disks and SSDs are very sensitive to damage from static electricity. Please observe all the usual electrostatic discharge (ESD) precautions when handling them.

Please see the section on mechanical shock and vibration later in this manual for information about how to handle and care for your disk drives

HDMI cables

Please remember that almost all HDMI cables do not use locking connectors and will simply pull out if they are jerked or tripped over. Please ensure your cables make a secure connection and avoid flexing them excessively to maintain reliability.

User Manual Conventions

To keep things simple but clear, we've only adopted two conventions in this manual:

 A helpful tip, suggestion or something to note because it's not obvious at first.

 An important note or warning

Credit to image used in Ninja above and all other instances to:

<https://unsplash.com/@freestocks>

Warranty & Conditions

International Hardware Limited Warranty

ATOMOS warrants that:

- The main product, not including the IPS screen, or any external accessories, will be free from defects in materials and workmanship for a period of 1 year from the date of purchase; or 3 years upon completion of product registration within 1 year from the date of purchase at www.atomos.com
- The TFT/LCD, HDD/SSD Docking Station, Master Caddy II and Cable will be free from defects in materials and workmanship for a period of 1 year from the date of purchase.
- This warranty is exclusively for the benefit of the original purchaser and is not assignable or transferable.
- If during the warranty period the product is shown to be defective ATOMOS may at its option:

- a) Replace the goods or supply equivalent ones,
- b) Repair the goods,
- c) Pay the cost of replacing the goods or of acquiring equivalent ones and
- d) Paying the cost of having the goods repaired;

The customer must notify ATOMOS of any defect in the goods in writing prior to the expiry of the warranty periods set out above. The customer will be solely responsible for returning the goods to ATOMOS or its authorized distributor. Upon acceptance of a warranty claim by ATOMOS, where ATOMOS repairs or replaces the goods, it will be responsible for reasonable shipping costs incurred in sending the goods to the Customer, provided that customer is located in a country in which ATOMOS has an authorized distributor or repair center or agent.

Warranty Exclusions

This warranty applies only to defects in workmanship and does not cover defects caused by:

- Neglect;
- Improper or negligent acts or omissions;
- Repairs or attempted repairs;
- Tampering with or modification of the goods;
- Connection to incompatible equipment or power sources;
- Exposure to water or weather;
- Exposure to magnetic fields or corrosive liquids or substances;
- Physical damage

Except as stated in this warranty, Atomos, its vendors, agents, resellers and distributors disclaim in their entirety all other warranties, express or implied, including without limitation all warranties of merchantability or fitness for a particular purpose. The remedies outlined in this warranty are the exclusive remedy a customer from defective goods, which are subject to the warranty.

Atomos does not warrant that the goods will operate in a manner that is error free, or uninterrupted. The goods are not intended to be the primary or only data storage device for data – customers are solely responsible for back up and protection of data.

Software License Agreement

IMPORTANT, PLEASE READ CAREFULLY. THIS IS A LICENSE AGREEMENT.

This ATOMOS software, related documentation, any included sample images files (the "Software"), is protected by copyright laws and international copyright treaties, as well as other intellectual property laws and treaties. The Software is licensed, not sold.

This End User License Agreement ("EULA") is a legal agreement between you (either an individual or a single entity) and ATOMOS with regard to the copyrighted Software provided with this EULA. Use of the Software provided to you by ATOMOS in whatever form or media, will constitute your acceptance of these terms, unless separate terms are provided by the software supplier, in which case certain additional or different terms may apply. If you do not agree with the terms of this EULA, do not download, install copy or use the Software. By installing, copying or otherwise using the Software, you agree to be bound to the terms of this EULA. If you do not agree to the terms of this EULA, ATOMOS is unwilling to license the Software to you.

1. Eligible licensees. This Software is available for license solely to purchasers of the ATOMOS Ninja V, who have purchased a unit manufactured by ATOMOS Ninja V and purchased through an ATOMOS authorized reseller, with no right of duplication or further distribution, licensing or sub-licensing.
2. License Grant. ATOMOS grants you a personal, non-transferable and non-exclusive right to use the copy of the Software provided with this EULA. You agree you will not copy the Software except as necessary to use it with the ATOMOS Ninja V. You agree that you may not copy the written materials accompanying the Software. Modifying, reverse engineering, translating, renting, copying, transferring or assigning all or part of the Software or any rights granted hereunder, to any other persons or reverse engineering the hardware on which the Software runs, is strictly prohibited. The software is licensed, not sold. You acknowledge that no title to intellectual property in the Software is transferable to you. You further acknowledge that title and full ownership rights to the Software will remain the exclusive property of ATOMOS and/or its suppliers, and you will not acquire any rights to the Software, except as expressly set forth above. All copies of the software will contain the same proprietary notices as contained in or on the Software. All title and copyrights in and to the Software (including but not limited to any images, animations, video, audio, text incorporated), the accompanying printed materials, and any copies of the Software are owned by ATOMOS or its suppliers.
3. Reverse engineering. You agree that you will not attempt, and if you are a corporation, you will use your best effort to prevent your employees and contractors from attempting to reverse compile, derive circuits, modify, translate or disassemble the Software and/or the Atomos Ninja V in whole or in part. Any failure to comply with the above or any other terms and conditions contained herein will result in the automatic termination of this license and the reversion of the rights granted hereunder by ATOMOS.

ATOMOS reserves the right to terminate this license without prejudice to any additional recourse ATOMOS may have against you if you violate any of its terms and conditions.

Notice

Copyright © 2021 ATOMOS Global Pty Ltd ('referred to as ATOMOS'). All rights reserved. All information in this document is subject to change without notice. No part of the document may be reproduced or transmitted in any form, or by any means, electronic or mechanical, including photocopying or recording, without the express written permission of ATOMOS. A reference to ATOMOS includes its related entities, subsidiaries and parent company.

Trademarks

Ninja V and ATOMOS are registered trademarks of ATOMOS. Apple, the Apple logo, AppleShare, AppleTalk, iPod, iPod Touch, Mac, and Macintosh are registered trademarks of Apple Inc. Final Cut Pro, QuickTime and the QuickTime Logo are trademarks of Apple Inc. DNxHD, DNxHR and Avid logo are registered trademarks of Avid Technology, Inc. All other trademarks are the property of their respective holders.

REGISTRATION + WARRANTY UPGRADE

Register within 12 months of purchase date to upgrade your standard 1 year warranty to a 3 year warranty.

Visit: my.atomos.com

Registered users receive updates of all AtomOS updates upon release.

Introduction

NINJA V

Thank you for choosing the Atomos Ninja V 5 inch 4Kp60 HDR Monitor Recorder. Featuring a super high-resolution screen in a lightweight aluminium alloy chassis, and an array of essential production tools including waveform monitoring, vectorscope, focus assist and the world's leading support for HDR monitoring; Ninja V will give you the creative and commercial advantage you've been looking for.

This user manual will get you up to speed with all the amazing features packed into the Ninja V that will assist you during a shoot and speed up your workflow on set and in post production.

Stay up-to-date with the latest information and software by registering your product today

www.atomos.com/support



1. What's included

NINJA V

Your Ninja V includes base accessories to get you started, such as a mains power supply and a media Master Caddy. Additionally you will need a 2.5" Solid State Drive (SSD) or AtomX SSDmini, a compatible HDMI cable (Camera out/Ninja in) and compatible batteries. Optional AtomX accessories including power and accessory kits are also available. Visit the Atomos website for the latest accessory options.

Not all drives are compatible with the Ninja V.
For the most up-to-date information please visit:
www.atomos.com/drives

Included:

- **Ninja V**
- **1 x Master Caddy II + screws**
- **12V-3A AC power supply**
- **Battery Eliminator**
- **Ninja V Quick Start Guide**



2. What you also need

Media

We have worked closely with drive manufacturers to develop media designed specifically for the Atomos Ninja V. The AtomX SSDmini is smaller than a standard SSD, but utilizes the same SATA connection as normal HDD/SSD media and is compatible with all Atomos recorders and docking stations. AtomX SSD mini fits directly into the Ninja V without the need for a Master Caddy II.



Widely available 2.5" SSDs are the basic storage media for Atomos 4K Monitor Recorders. We work closely with leading drive manufacturers to qualify as many options as possible. SSDs are required for 4K recording or for more demanding production environments that may not be suited to spinning hard disks.



Which drives should you use?

There are so many drives available, and newer models appear all the time. To avoid potential data loss and/or write/read errors, Atomos only recommends the use of approved SSD media only.

We are not able to test all drives but here are some guidelines.

Solid State Drives (SSDs) are recommended for all recording up to 4KUHDp30 and specific drives with sustained high performance write speeds for 4KDCI 60p and RAW.

Spinning Disk Drives (HDD) are not recommended.

HDDs are not suitable for 4K recording or for use in environments or situations where they are subject to movement.

Speed and reliability are the main factors. Here are a few things to bear in mind:

- Disk drive data rates tend to be given in megabytes per second, and codec data rates are normally given in megabits per second. It's very easy to get confused. But there's no need to be, because all you have to do to convert megabits to megabytes is divide by 8. So if you're recording at 220 megabits per second, that's going to result in $220/8$ megabytes per second, which is 27.5 megabytes per second.
- With 4K recording your data rate is approximately four times that of HD recording, so please ensure your drive is capable of keeping up with 4K write speed requirements.

Atomos regularly tests drives – please check this link before purchasing drives: www.atomos.com/drives

Mechanical shock and vibration for Spinning Disk HDDs

Hard disks are precision mechanical devices that need to be handled carefully. The use of mechanical drives or Solid State drives will vary depending on the intended filming application.

We can't give rigid guidelines because there are so many different kinds of drives, each which has different mechanical properties. You may even find variations between drives of the same type.

What we have found is that mechanical drives are suitable for most purposes that don't involve harsh vibration or mechanical shocks. We would not advise using mechanical disks if there is a likelihood that they might be shaken or dropped onto a hard surface.

Here are some things that you should bear in mind when using spinning disks:

- Even though spinning drives can withstand substantial shocks when they are not in use, they are more vulnerable when running. Harsh treatment that may not actually damage the drive may interrupt recordings at a much lower level of severity. We recommend that you experiment with your drives by testing them in the conditions that you normally work in.
- Do not bang or jolt the Ninja V while recording.
- Do not use spinning drives (HDD) for recording 4K video
- You will find noticeable differences in the ability of different drives to withstand shock and to continue recording during vibration and movement.

Secure Erase

For drives that carry the Atomos Logo such as the G-Technology 4K SSD, Angelbird 4KRAW, AtomX SSDmini by Angelbird and Sony, an option for Secure Erase is presented. This allows for the entire drive including the drive cache to be formatted. This will erase ALL content on the drive meaning nothing can be recovered. It will wipe all data off the drive (which may also be useful as a additional security measure) and reset it back as close as possible to factory conditions. The benefit of this feature is that it helps to maintain maximum drive performance, and therefore should be used when available.

2. What you also need

Backing up and archiving

Remember that no storage media, including tape, optical disks, spinning disks and flash memory, is completely immune from failure.

You should bear this in mind when deciding how to manage your recorded content. At the very least, you should consider the consequences for you and your business if your storage media were to suffer from a sudden failure, and you should back up your content accordingly.

Deleting files

To ensure the integrity of data writes and to avoid situations such as fragmentation, the AtomOS operating system on the Ninja V does not support the deletion of files. We also do not advise removing or deleting files randomly from the disk on your computer. Often files are left in the trash or garbage partition of the drive occupying drive cache and this can affect drive performance. It's advised that you archive your content and reformat the drive before each shoot. For more details refer to the Using the Ninja V - Best Practice section.

HDMI cables

Take care to use HDMI cables of the appropriate grade and ensure that you protect them from damage. Signal issues can often result from damaged HDMI cables, or from using cables that are too long.

Atomos makes a range of professional HDMI cables which are ideal for connecting between your camera and Ninja V. For 4Kp50/60 and RAW recording we advise the use of Atomos HDMI 2.0 cables.

Not all HDMI cables are created equal and there are a variety of different qualities available. Please make sure you test your cables prior to shooting. This is particularly important when recording 4Kp50/60 and RAW. Many cables will claim to be high speed but will lack the required shielding on both cable and connector to maintain a high quality signal. If the signal contains errors that affect your recording, your Ninja V may not lock to these inputs



Also check your connectivity at both the camera connector and the recorder/monitor connector to make sure you have a firm connection to avoid any signal drop out.



If the HDMI cable is removed while recording, the "Skippy" image will also be displayed. To remove, tap Skippy icon and it will disappear, ready for the next notification.

Standard 1/4" or 3/8" Mount/Arm

The Ninja V is designed for versatility – including multiple mounting options to suit just about every possible scenario. The unit includes both 3/8-16 and 1/4-20 screw mounts top and bottom, along with an ARRI style anti-rotational pin system for secure mounting to a wide range of arms, mounts and cages. It is compatible with the latest mounting solutions from companies such as Shape, SmallRig and Wooden Camera. Select the mount type that best suits your input device, application and conditions.



Ninja V (top view) shows 3/8-16 and 1/4-20 (adaptor) mounts and ARRI style anti-rotational mount system. Below are some examples of tripod and hot shoe mounts, available from most camera and video specialists.



A secure mount will greatly enhance usability and security of HDMI, power, remote and audio connections.

3. Mounting disks in the Master Caddy II

Mounting drives in the Master Caddy II

If you choose to use your own disks instead of a pre-built AtomX SSDmini then follow this procedure to install it in the provided Master Caddy II.

Insert the disk into the caddy, and secure with four screws. These screws should be tightened so the screw heads are flush with the casing of the caddy. The caddy is light and the disk just needs to be held securely. Don't over-tighten the screws. There are no connections to make because sliding the Master Caddy II into the Ninja V or the docking station makes all the connections for you.

The Master Caddy can't be inserted the wrong way round. Always make sure that the disk connector faces the slot in the Ninja V. Push the Master Caddy II into place, but never force the disk just in case something isn't set up or aligned properly.

There is very little that can cause problems, but if there is an issue it is likely that the Master Caddy isn't properly flush with the drive inside. A quick visual check will confirm this.

- ⚠ *Spinning disks and SSDs are very sensitive to damage from static electricity. Please observe all the usual precautions when handling them and NEVER touch the exposed SATA connector as static electricity may be harmful to your disk.*
- ⚠ *Master Caddy II drives are backwards compatible with previous Atomos recorders, however Master Caddy 1 is not forward compatible with the Ninja V due to the compact latch design.*

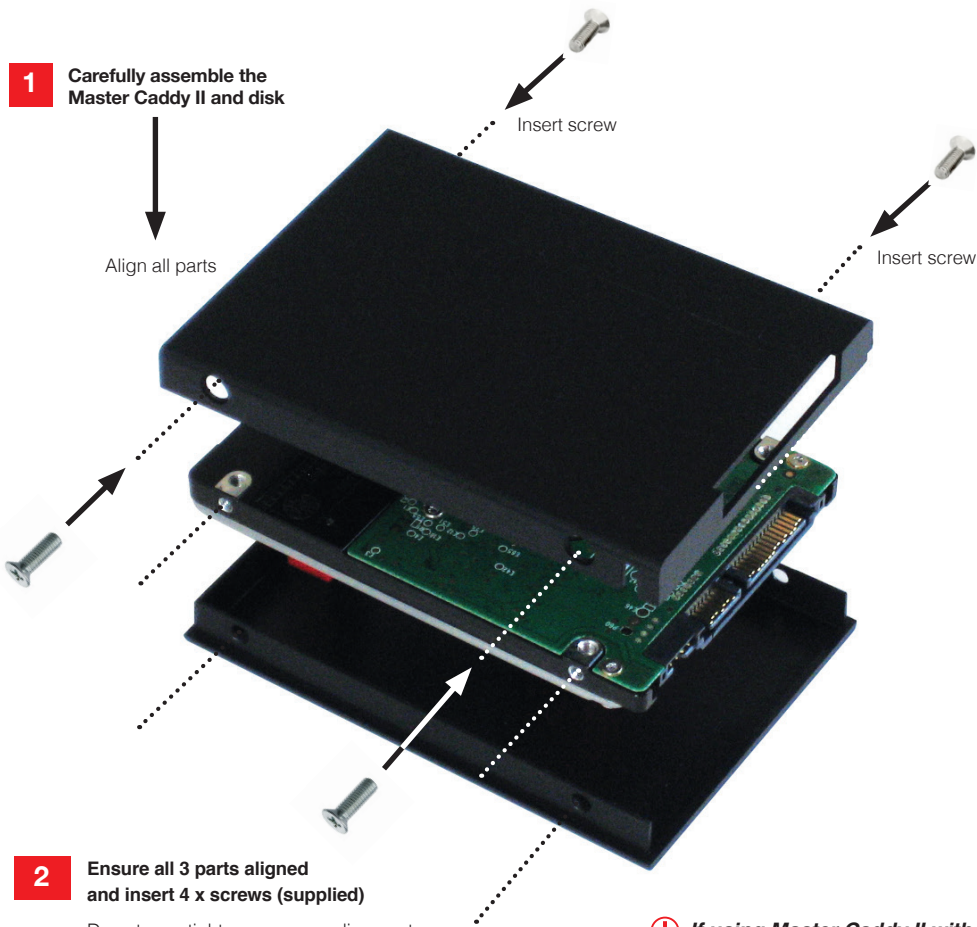

Do not over-tighten screws or alignment can not be guaranteed. We suggest squeezing the corners together near the screw you are tightening for optimal fit.

⚠ *If using Master Caddy II with Ninja V ensure all screws are tight and not protruding from casing. Loose screws may cause the caddy to become lodged in the disk slot.*



AtomX SSDmini

Atomos has teamed with the world's leading media manufacturers to design SSD media that is better suited to our ever evolving Monitor Recorders. The AtomX SSDmini is a little over 1/4 inch tall and 3" long. It is also 20% shorter than traditional SSDs, yet keeps the standard SATA III connector. It is backward compatible with previous Atomos devices by adding a clever extension handle (SSDmini Adaptor). These tiny, slimline SSDs are a true innovation by our close drive partners Angelbird and Sony. 1 TB AtomX SSDmini by Angelbird pictured (right).



4. Connecting and Powering Up



Choosing your power source

The Ninja V can be powered by the included AC-powered Battery Eliminator, or by using a compatible DC battery. If you are the owner of other Atomos devices, the batteries you have for these devices (NP-F series) will be compatible with your new Ninja V.

Battery Eliminator

Included in the Ninja V box is a Battery Eliminator. This connects directly to the battery slot of your Ninja V and enables AC power connection. Please note the Battery Eliminator is suitable for use with Atomos devices only and is compatible with the Atomos coiled DC to D-Tap cable.

Batteries

We recommend the use of optional Atomos NP-F type batteries and the Atomos Power Kit with the Ninja V. The Ninja V can also use standard NP-F compatible batteries. Charge new batteries before using them, using a compatible battery charger. To attach the battery, gently slide it down into the slot until it locks into position. To remove a battery, push the latch to release it.

 Before any type of disposal the battery should be discharged completely. Tape the contacts with electrical tape and package so as to prevent contacts accidentally coming together at any time.

 Incineration must be performed by an approved and permitted waste treatment facility that handles lithium ion batteries. If you are not sure if your waste facility can handle lithium ion batteries, contact them and verify if they are permitted or not.

Atomos NP-F Battery Charger (optional)

The Atomos NP-F Battery Charger has been designed to rapidly charge the batteries yet be lightweight so that is easy to travel with.

In the unlikely event of a charge error the first and fast red LEDs flashing quickly.

 Fast charging of the battery is possible up to 80% capacity and the remaining 20% will then charge at a slower rate to maintain good battery life.

 Batteries do not charge in a linear way. At first they charge very quickly, and then the rate slows down to a trickle. While charging, one or more red lights will blink. When 90% charge is reached, all the lights will flash. It is perfectly OK to use the batteries at this point and we recommend stopping at this stage for the longest battery life. If you leave the batteries on charge after all four lights are flashing, the charger goes into trickle charging mode for the final 10%. Eventually, when trickle charging is complete, and the batteries are at 100% charge, all the lights will go out.

Battery slot

Gently slide down into battery slot and lock into position

Push the release button to unlock the battery and slide battery upwards to remove.

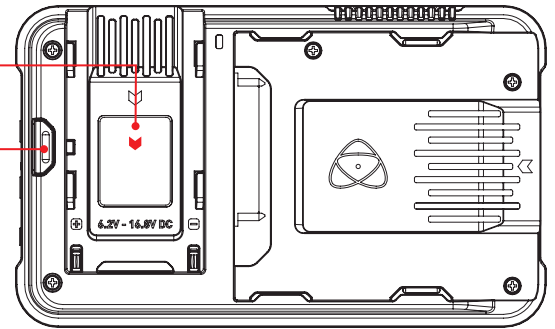

Choosing the right battery for your application

Size	Cells	Battery Life*
5200mAh	4	Up to 2.0hrs
7800mAh	6	Up to 3.0hrs
Battery Eliminator	-	Continuous AC
D-Tap	-	Source dependent

* Battery life tested during Monitor/Record 4Kp60 operation.

 We recommend using Atomos NP-F series batteries.

DC to D-Tap Coiled Cable

An optional Atomos accessory is a DC to D-Tap Coiled Cable. This is designed to allow you to power your device from an external battery system. To use this simply connect the D-Tap connector to your power source. Ensure that the output of the power source does not exceed 16.8V DC.

 Ninja V batteries and modular accessories are held in place tightly because they are on the outside of the device, this is to ensure there is no possibility whatsoever that they work loose, so you may have to be quite firm with the battery latches. We suggest that you familiarize yourself with the force required to remove the batteries and accessories so that you can do this quickly in the field.

Powering the AtomX CAST

When you have an AtomX CAST connected to your Ninja V, the 12V-3A AC power supply that was included with your Ninja V supplies power for both Ninja V and AtomX CAST. Connect the DC connector to the DC input on the AtomX CAST to provide power to both devices. For more information on the AtomX CAST connections, refer to the Ninja V Connections section.

Connecting the AtomX CAST to your Computer

The AtomX CAST connects to your computer via USB-C and appears instantly to the computer as a webcam. Connect one end of the supplied USB-C cable to the USB-C port labelled CAST USB-C on AtomX CAST and the other end to a USB-C port on your computer. If your computer only has USB Type-A connectors, a USB-C to USB-A adapter will be required. Once connected, you will be able to select the AtomX CAST as a camera and audio source within video applications like Zoom, Teams and Skype without the need to install drivers on the computer first.

4. Connecting and Powering Up

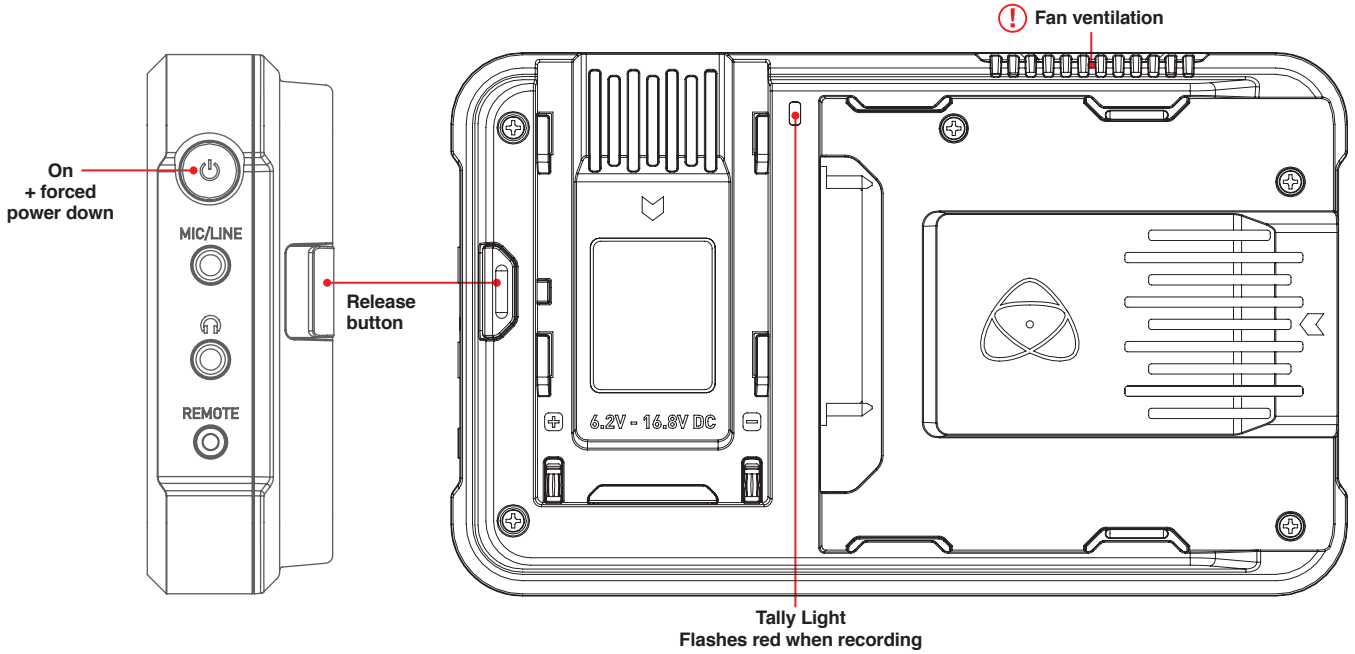

Turning ON power to the Ninja V

The start button is located on the top right hand side of the unit (as you look at the screen). With a charged battery attached, momentarily press the recessed circular button on the top right side of the Ninja V. After a couple of seconds you will see the Atomos logo, and then the Ninja V Home Screen.

Turning OFF power to the Ninja V

To turn the unit off, touch the **battery** icon on the top right of the home screen, and then **press the green Power icon for 4 seconds**. The icon will go red when touched to indicate activation of the button. The unit will then power off. You can also do a forced power down by **pressing the on/off button for four seconds**.

Battery - Menu Screen



Four seconds can seem like a long time! We've made it this way to make absolutely certain that the Ninja V can't be turned off accidentally.

Do not press and hold the power button in on the Ninja V while the unit is off. This will place the device in to a Firmware recovery mode. If you accidentally do this, simply turn the device off again or remove the power source.

! Take note to respect the air flow and do not to obstruct the cooling vents of the unit.

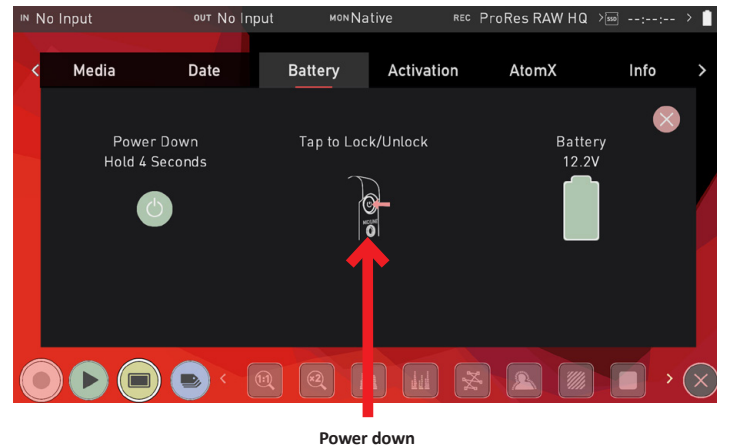

5. Ninja V Connections

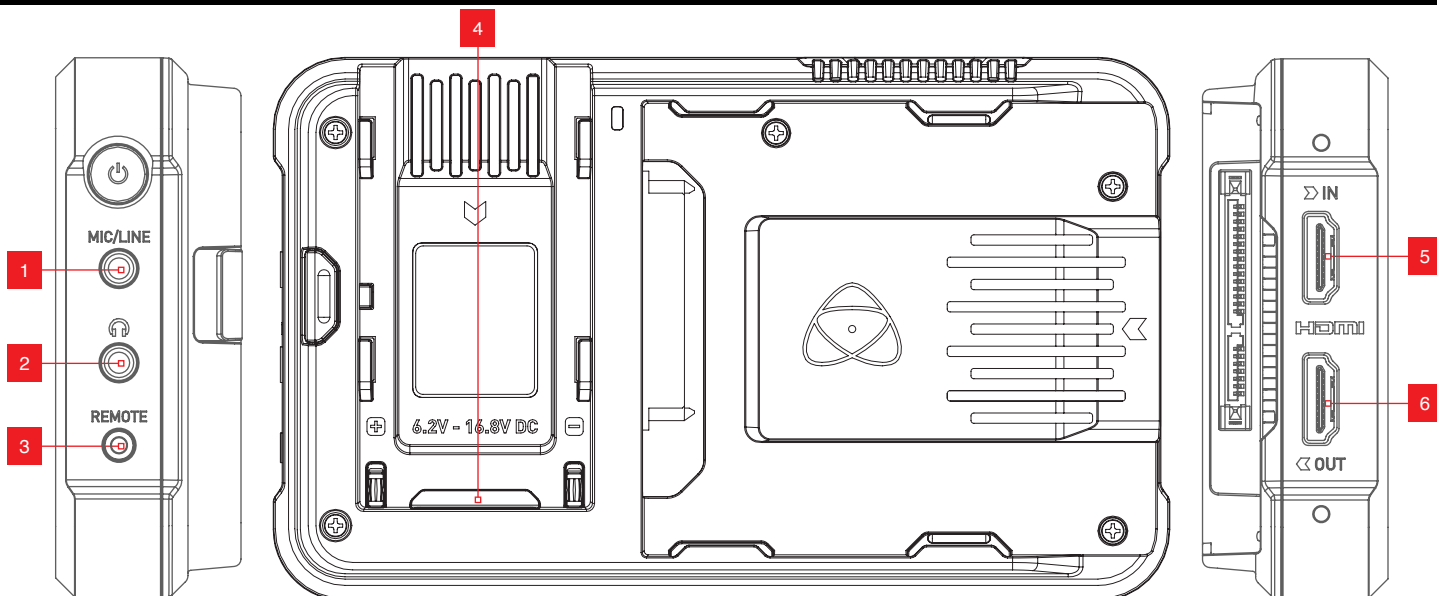

1. Mic/Line in

A 3.5mm input jack is located under the power button. Channel selection and volume for headphone monitoring is via the audio controls section, accessible by touching the audio meters in the upper right side of the touchscreen (monitoring mode) or in the bottom right of the screen (homescreen mode).

2. Headphone/audio out

A 3.5mm headphone jack is located above the remote port. Channel selection and volume for headphone monitoring is via the on-screen audio controls section, accessible by touching the audio meters in the upper right side of the touchscreen (monitoring mode) or in the bottom right of the screen (homescreen mode).

 *When monitoring any channels please ensure that the headphone selection is set to the stereo pair you'd like to monitor. For more details refer to Audio in the Using the Ninja V section.*

3. Remote/Calibration Port

The calibration 2.5mm jack on the right hand side (looking from the front), allows for the connection of the Calibrite ColorChecker Display Pro / Display Plus calibration device. The calibration unit utilizes the optional USB to serial adaptor cable. For optimal calibration it is recommended that your Ninja V is powered for 30 minutes prior to calibration. The latest version of the Atomos Calibration software is available at www.atomos.com/support

For remote operations, via this port, AtomOS supports both LANC in Sony and Canon format. The Ninja V uses LANC Client so a LANC controller must first be attached to a camera and the output taken out via a Y cable to the Ninja V.

4. AtomXpansion Port

Enhance your Ninja V through the built-in modular AtomXpansion port. Bi-directional high speed video, audio and power are available. Expansion modules dock into the battery slot and can be stacked, passing power and offer advanced connections and functions. www.atomos.com/accessories

5. HDMI in

The video input is a full size HDMI 2.0a connection used to receive the video. This connection also supports embedded audio and timecode if your camera or device sends these out over HDMI. The image is both displayed and recorded to the Atomos monitor/recorder storage media.

Embedded Audio: Most mirrorless cameras and camcorders send 2 channels of audio over HDMI but the Ninja V can record up to 8 channels of digital audio embedded in the HDMI signal if supported.

6. HDMI Out

This is for connection to an external monitor or other device with an HDMI input. It carries a loop-through of the incoming HDMI signal in record and standby mode, and the playback signal when the Ninja V is in playback mode. This output is 2.0a and can carry either a 4K or HD signal (with the option to down convert the 4K input to HD).

Video Scale Convert: Video out also has the option for a downscale to be applied allowing your 4K input to be converted to a 1080 HD output for use with existing HD equipment. DCI signals with a 17:9 aspect ratio have the option to be cropped to 16:9 to support a wider range of output displays.

3D LUT Output

3D LUTs can be applied to the outputs of the Ninja V and LUTs can also be selected to be applied to the outputs and routed out to other equipment via the HDMI connections.

HDR Output

The Ninja V can read the incoming HDR information frame from compatible cameras that indicates if a signal is HLG or PQ. You can set the Ninja V to automatically detect this and loop this out. You can also convert between a Log input to HDR display standards or between HLG ↔ PQ, and Dolby. For more information refer to Understanding HDR and Log in the Monitoring and Recording section.

5. Ninja V Connections

7. AtomX Expansion Modules

AtomX expansion modules attach to the AtomXansion port on your Ninja V, and provide additional connections and functionality.

AtomX SDI Expansion Module

The AtomX SDI Expansion Module (A) adds the quality and convenience of SDI connectivity to your Ninja V, which allows you to monitor and record SDI video up to 4Kp60 from a range of professional cameras and video sources. The two BNC connectors (B) allow for input and output connections, so you can send video to or receive video from any SDI device. This provides flexibility for any video or film production to allow all crew including directors, cinematographers, assistants and focus pullers to monitor and replay identical and calibrated content in HDR at the same time.

The AtomX SDI Expansion Module also allows you to cross convert signals between HDMI and SDI. This means that where HDMI sources are connected to your Ninja V, an SDI signal can be output from both of the BNC connectors on your AtomX SDI Expansion Module.

Where an SDI video signal is connected to your AtomX SDI Expansion module, you can output an HDMI signal over the HDMI out on your Ninja V. For more information refer to the Cross Conversion section in the Input section. To use the AtomX SDI Module with your Ninja V, firmware version 10.1 or later needs to be installed.

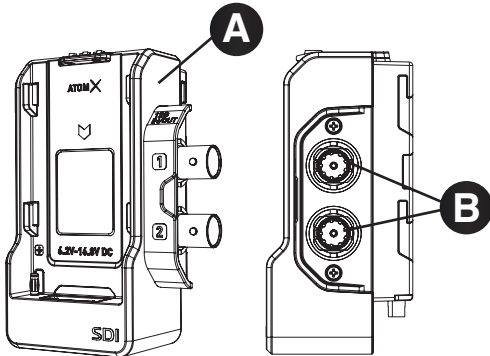

SDI RAW

You can add the SDI RAW feature to your Ninja V by purchasing the optional SDI RAW upgrade at my.atomos.com.

After activating the feature on your Ninja V, you can use the AtomX SDI Expansion module to record RAW over SDI from compatible cameras. Refer to Activation section for more information on the activation process. To use the AtomX SDI Module for SDI RAW, firmware version 10.6 or later needs to be installed on your Ninja V.

 *When RAW over SDI is enabled on a connected camera, your Ninja V will automatically detect the RAW signal and prompt you to select ProRes RAW as the recording codec.*

AtomX SYNC Expansion Module

The AtomX SYNC Expansion Module (C) adds professional wireless timecode and sync to any HDMI camera or source, making it easy to integrate consumer cameras into multi-cam productions. This allows for perfect synchronization with a range of other products including iOS devices, professional audio recorders and cameras.

The Atomos UltraSync ONE and UltraSync Blue can also be used to bring multiple cameras and devices into perfect sync.

The result is that your footage and audio from multiple sources will be perfectly aligned when you bring it into your NLE timeline. You can sync and/or control any number of Ninja V units equipped with AtomX Sync modules on the same network at ranges of 200m+. AtomX Sync also has a built-in battery extender that allows for continuous power when swapping batteries, ensuring uninterrupted operation of the Ninja V during a shoot. For more information refer to the AtomX SYNC Expansion Module section. To use the AtomX SYNC Module with your Ninja V, firmware version 10.4 or later needs to be installed.

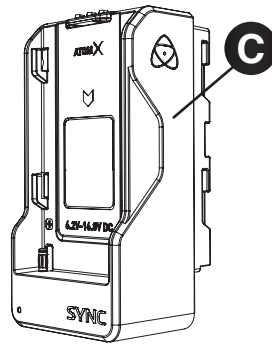

AtomX CAST

The AtomX CAST is a modular companion that transforms the Ninja V into a 4 input HDMI switcher. The combination of the Ninja V and AtomX CAST becomes the Ninja CAST, a fully functional stand-alone switcher with an integrated high quality 5" HDR touchscreen monitor with multi-view, broadcast quality recording and physical buttons - that can be used anywhere and does not require a computer to function. The flexible control options allow you to use either the touchscreen or the physical buttons to 'switch' between sources when deciding what should be on screen at any one time for broadcast.

Ninja CAST appears as a high-quality webcam to your computer, and it works immediately with your video applications like Zoom, Teams and Skype without the need to install drivers on the computer. Create broadcast quality multi-camera programs and use features like logos, graphics and picture in picture to enhance your online meetings, presentations, conferences, remote learning/training, virtual conferences or demonstrations. To use AtomX CAST with your Ninja V, firmware version 10.71 or later needs to be installed.

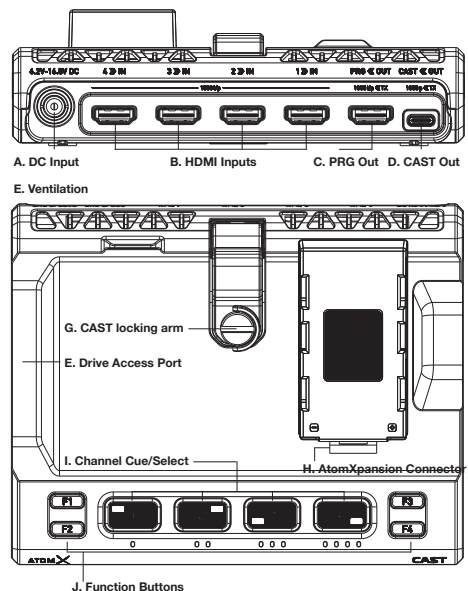

6. AtomX SSDmini, Master Caddy II and Screw Mounts

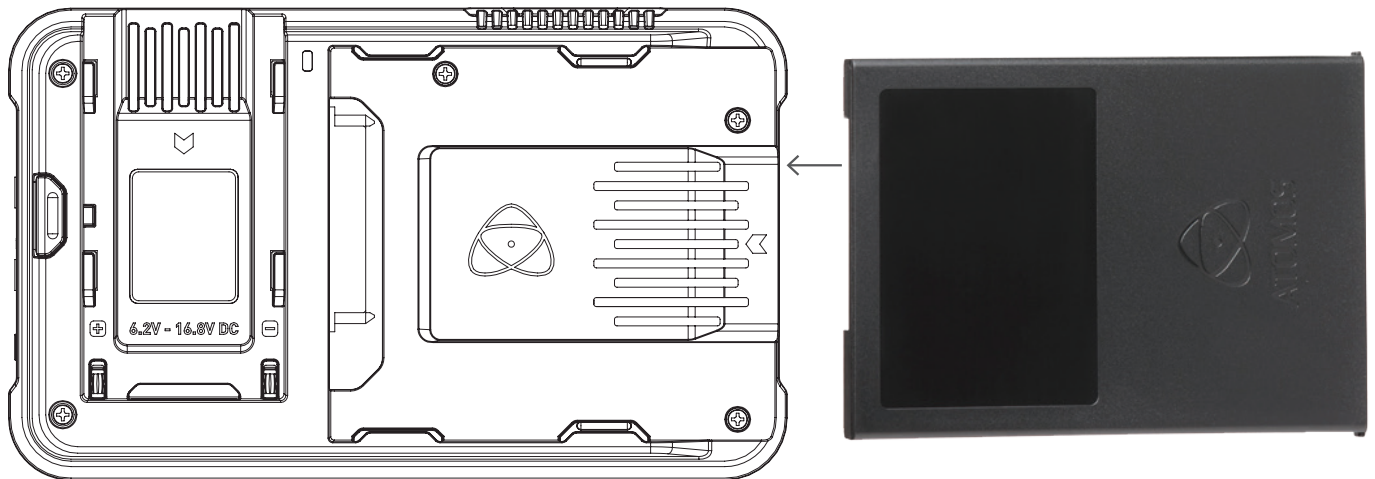

AtomX SSDmini / Master Caddy II Slot

On the rear of the unit is a 2.5" slot designed for Master Disk Caddy II or AtomX SSDmini. To insert your caddy or SSDmini, gently push until it stops at the end of the drive slot.



The SSDmini and Master Caddy II are both hot-swappable, so you can do this at almost any time – even while the unit is turned on. But don't do it while recording or you will get a corrupted file that may be unplayable.

- ❗ *The Ninja V disk slot does NOT have a release latch - it is friction-fit. Simply pull the SSDmini / Master Caddy II out using the top and bottom tabs on the caddy itself.*
- ❗ *AtomX SSDmini is backwards compatible with previous Atomos recorders. The original Master Caddy 1 is not compatible with Ninja V as the keyways are on one side only.*
- ❗ *The AtomX SSDmini Handle is available as an optional accessory, and can be attached to your SSDmini. This allows it to be used with existing Atomos Master Caddy II devices, and also reduces handling and potential damage to the disk casing.*

Flexible mounting options

The Ninja V is designed for versatility – including multiple mounting options. The unit includes both 3/8"-16 and 1/4"-20 screw mounts top and bottom, along with an ARRI style anti-rotational pin system, ensuring it is secure on gimbals, and compatible with the latest mounting solutions.

The 1/4" adaptor is easily removed for mounting on 3/8" fixtures. To do so use a flathead screwdriver to gently loosen the adaptor and store your adaptors in a safe location.

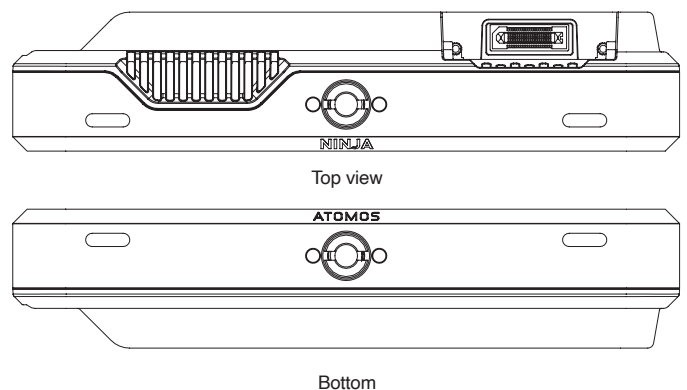

- ❗ *Ensure you do not over tighten the screw mounts as this may cause damage. Do not insert a 1/4-20" or 3/8"-16 thread longer than 5mm or you will risk causing damage to the aluminium chassis.*

7. Using the Ninja V

NINJA V



With the AtomOS10 Operating System for Ninja V, there have been some significant changes in the way we do things compared to our previous models – especially in the overall look and feel, the placement of buttons, and the way that AtomOS10 works.

With AtomOS10 you get the ultimate touch interface for monitoring and recording. This new version of our operating system has a clear, elegant design. It's easy to understand yet gives you total access to all functions. No complicated sequences of buttons. No endless menus crowded with text. It's optimized for our latest AtomIC hardware platform. And it's extremely responsive with fast boot up times.



7. Using the Ninja V - Best Practice

Understanding the basic controls and ‘housekeeping’ functions will save you time in the future. Before you start enjoying your Ninja V it will help to set the date and time, the ‘device name’ and file naming conventions.

- Date & Time
- Format Media
- Unit Name
- File Naming
- Screen Lock
- AtomOS Updates (firmware)

A. Date & Time

It is vital you set the correct date and time on your Ninja V to ensure that the metadata for your files is correct.

To access the Date & Time, tap the input indicator from the home screen Information bar.

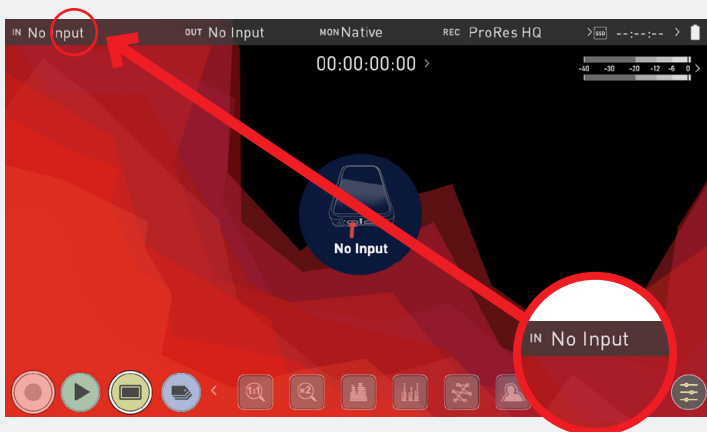

Then swipe the menu tabs to the left to navigate to the DATE TAB.

 **Swipe left to reveal more tabs, more icons, and more settings. If you cannot find the menu you are looking for, swipe left or right.**

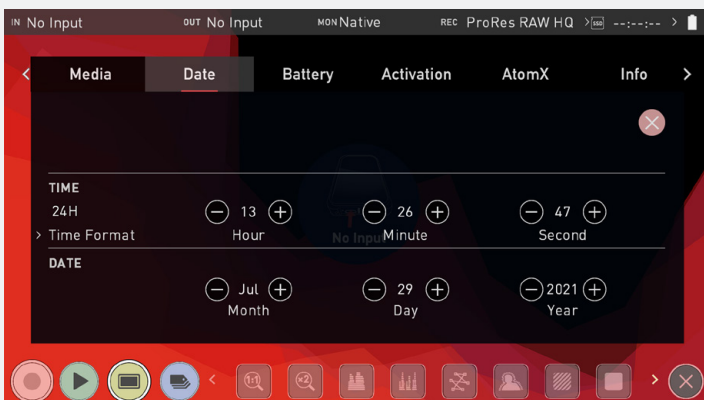

Use the plus and minus icons for each setting to set the time and date used on the Ninja V. For more information refer to the Date page in the Using the Ninja V section.

B. Format Media

Make sure your drive is correctly inserted and all data from previous shoots has been securely backed-up. Touching the **Storage Capacity Indicator** on the home screen will take you to the Media Menu.



This menu provides information on the drive currently inserted. To format the drive touch the **Format** button (below).



 **If you do not see your hard drive information, there may be a problem with the connection or drive. Try removing the drive and reattaching the drive. Ensure correct alignment of Master Caddy II or SSDmini.**

 *The Ninja V uses the exFAT file system for broadest compatibility.*

7. Using the Ninja V - Best Practice

Secure Erase Format

For drives that carry the Atomos Logo such as the G-Technology 4K SSD, Angelbird 4KRAW, AtomX SSDmini by Angelbird and Sony, an option for Secure Erase is presented. This allows for the entire drive including the drive cache to be formatted. This will erase ALL content on the drive meaning nothing can be recovered. The benefit of this is to optimize performance. It will wipe all data off the drive (which may also be useful as an additional security measure) and reset it back as close as possible to factory conditions.

 When you first insert a drive you may be presented with "Invalid media". This display means that the drive has not yet been formatted and you simply need to format your drive before using it.

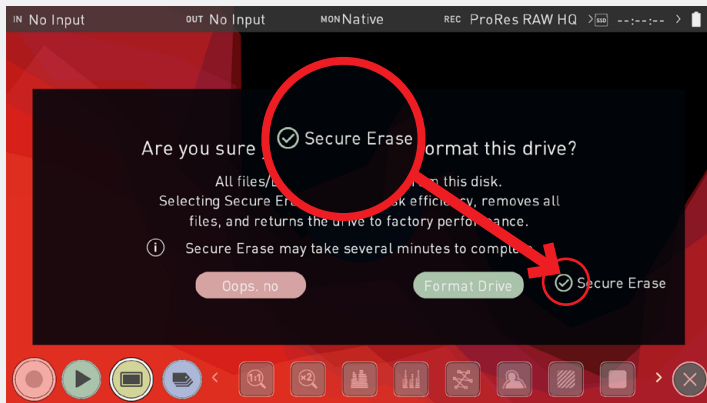

C. Unit Name

To access the unit name tap the **input indicator** from the home screen Information bar.

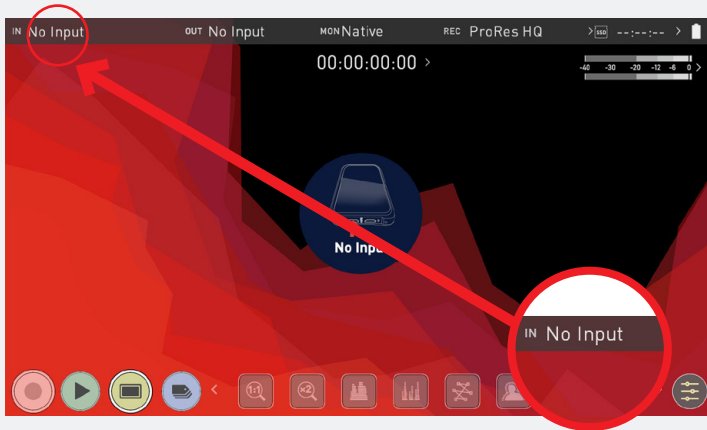

Then navigate to the **FILE TAB**

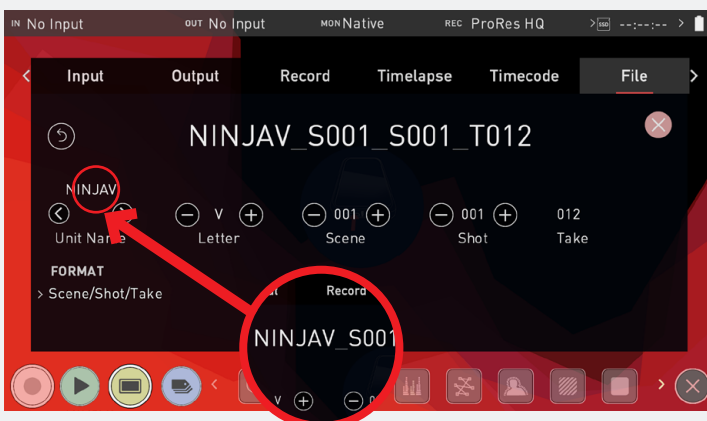

The unit name serves two main purposes:

- **Drive Naming:** Giving the unit a unique name aids with identification. Once you have given it a name all drives subsequently formatted in the Ninja V will bear this name as a prefix.
- **File Naming:** The current unit name appears at the start of the recorded clip name; `NINJAV_S001_S001_T001`

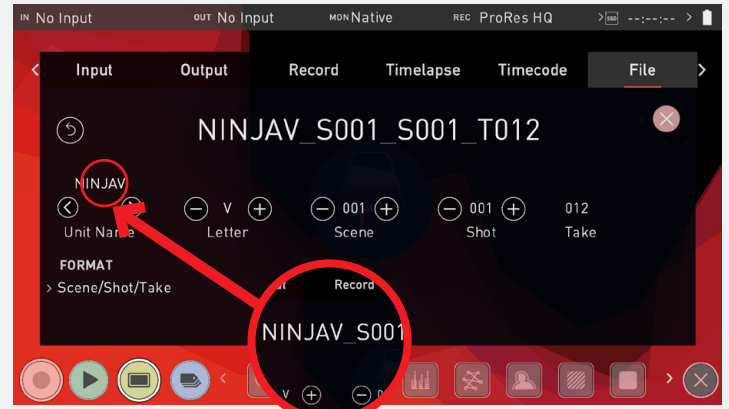



- Using the **Select <>** choose the letter to update. The character you are updating will display in the Letter indicator.
- Use the **Letter - +** to change the character. When the correct letter is displayed, use the select control to move to the next character.
- Scene and shot can also be set using the + - controls. Take is automated.

D. File Naming

To access the unit name and file naming screen simply follow the steps listed previously in 'Unit Name'. Create your own unit name by pressing the arrow to change and enter the letters in. Pressing OK will allocate the new unit name and return you to the menu screen.

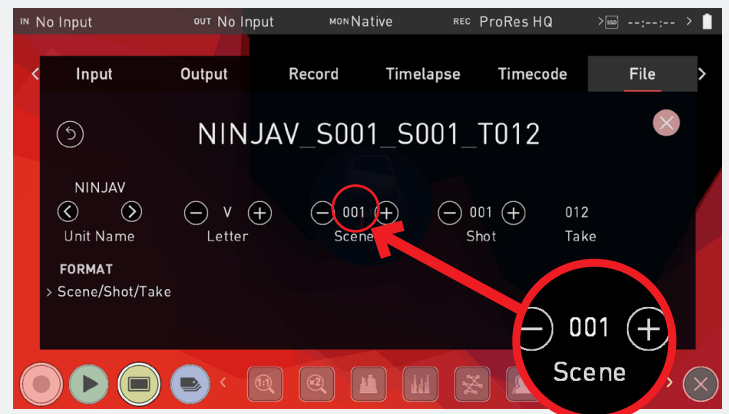
This process can be very useful when using multiple devices or with multicam shoots. Good file management now will save you valuable time in post production.



 When **changing the drive** please ensure that you take note of the last scene and take number so you can append this, as formatting a drive will reset the scene and take counter to 001,001,001.

7. Using the Ninja V - Best Practice

E. Screen Lock

Lock the Display Screen

You can lock the display of the Ninja V by tapping the power button. This will ensure no changes can be made by mistakenly touching the screen. The screen lock function will simultaneously lock or unlock both Channels of the Ninja V. Short tap the power button again to unlock the unit.

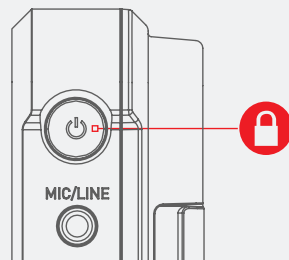
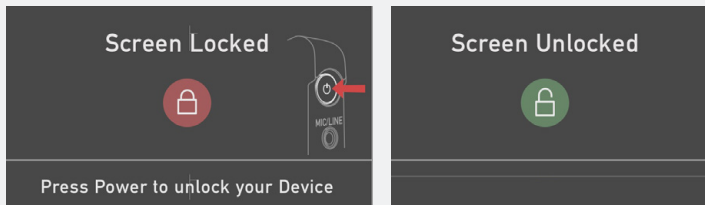

 The lock screen can be combined with the Display Off function so that when lock is engaged the display is turned off. The Tally light on the front of the unit will still display Rec (Red) or idle (green) status. The Display Off function can be found under Monitor in the Monitoring and Recording section.

F. AtomOS Updates (Firmware)

From time to time we will issue software updates for your Ninja V. To update the firmware (that's the software that runs inside your Ninja V), there is a simple procedure you have to follow.

- Check your current Firmware version. Navigate to the Info tab by first pressing either the input, output, codec or media indicators and then navigating through the menu. If at first you do not see the info tab, swipe the tabs bar to the left to reveal more menus and settings.

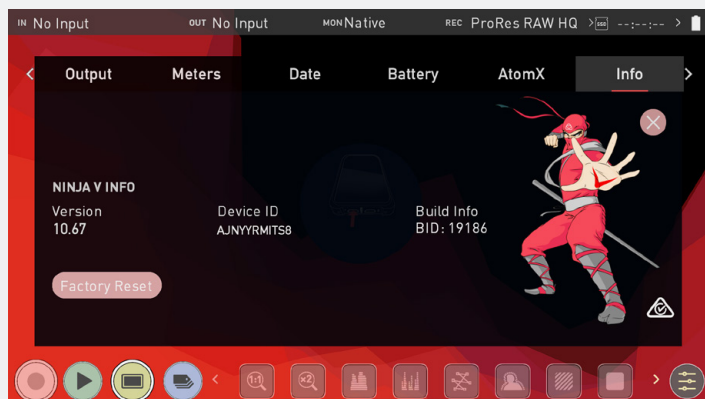

The info screen contains the firmware version number and other important information about your Ninja V. To determine if your device is up-to-date or if a firmware update is required.

- Go to www.atomos.com/support
 - Locate and download the firmware upgrade
1. Extract the file ATOMNJV.FW from the firmware zip file.
 2. Copy ATOMNJV.FW onto a drive in a Master Caddy.

- a. Atomos recommends you use a freshly formatted compatible drive.
 - b. Always format your drives in the Ninja V first. The Ninja V formats the drive for optimal performance for video.
 - c. Ensure that the firmware update file is on the root of the drive, and not in a folder on the drive.
3. Use a freshly charged battery on your Ninja V or connect to mains power. It is very important that your Ninja V does not lose power during a firmware upgrade.
 4. Power down your Ninja V.
 5. Insert the Master Caddy with the ATOMNJV.FW file.
 6. Power up your Ninja V with a short press of the Power Button.
 7. Watch the screen. The Atomos logo will appear, and then be replaced with a Please Wait message and after a few seconds the firmware upgrade will start.
 8. While the firmware upgrade is happening, an 'updating firmware' screen will appear.

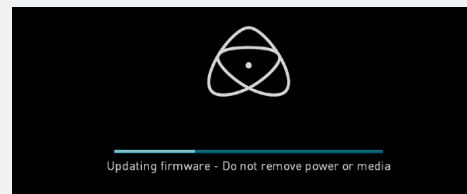

9. The firmware upgrade will take up to a few minutes.
10. When the firmware upgrade is finished, the Ninja V will:
 - a. Delete ATOMNJV.FW file from your drive.
 - b. Power itself down.
11. Turn on your Ninja V again with a short press of the Power Button located on the side.
12. When the Ninja V has booted, Press the Settings Button and select Info tab and check that the version number is the version expected.

IMPORTANT: Problems when installing AtomOS

Very rarely, the firmware update process can go wrong. This might be because of an incomplete or corrupted download.

In the unlikely event of your Ninja V becoming unresponsive, there is a built-in recovery mechanism.

All you have to do is press and hold the on/off button for 10 seconds. If you do this your Ninja V will revert to its factory condition, and you will be able to retry the firmware update later (taking due precautions to identify and remove possible reasons for the failure of the previous attempt).

 If using batteries for power, ensure that they have plenty of charge and that you do not interrupt your Ninja V while its firmware is upgrading. You will see a progress bar to the lower half of the screen. When it is finished, the Ninja V will restart and you will be able to use the device as normal. This process can take up to 5 minutes.

 Please make sure that the firmware file is not renamed when your computer unpacks the ZIP file. If you have other firmware in the same folder, the file may become renamed to ATOMNJV-1.FW when unzipping and the update will not work.

 If you place the .FW file on the drive and insert this in to the Ninja V whilst it is turned on, the device will recognise the firmware update and ask if you'd like to apply the update. If you select "ok" the device will shut down and begin the update process.

7. Using the Ninja V

The Main Screen - Home Screen

The AtomOS10 homescreen is designed for unobstructed monitoring at all times. The clean and uncluttered design of AtomOS10 concentrates the attention on the image, not on the device's operation. From the muted main button controls through to flexible histogram size and positioning, all on-screen

controls are non-obtrusive and incredibly intuitive to use. Monitoring tools are only one-touch away, and now allow for a better view of your subject while adjusting monitor-assist functions such as focus peaking and false color. Record, Playback, Monitoring and Edit features are easier than ever to use.

Monitor Mode / Home

SETTINGS

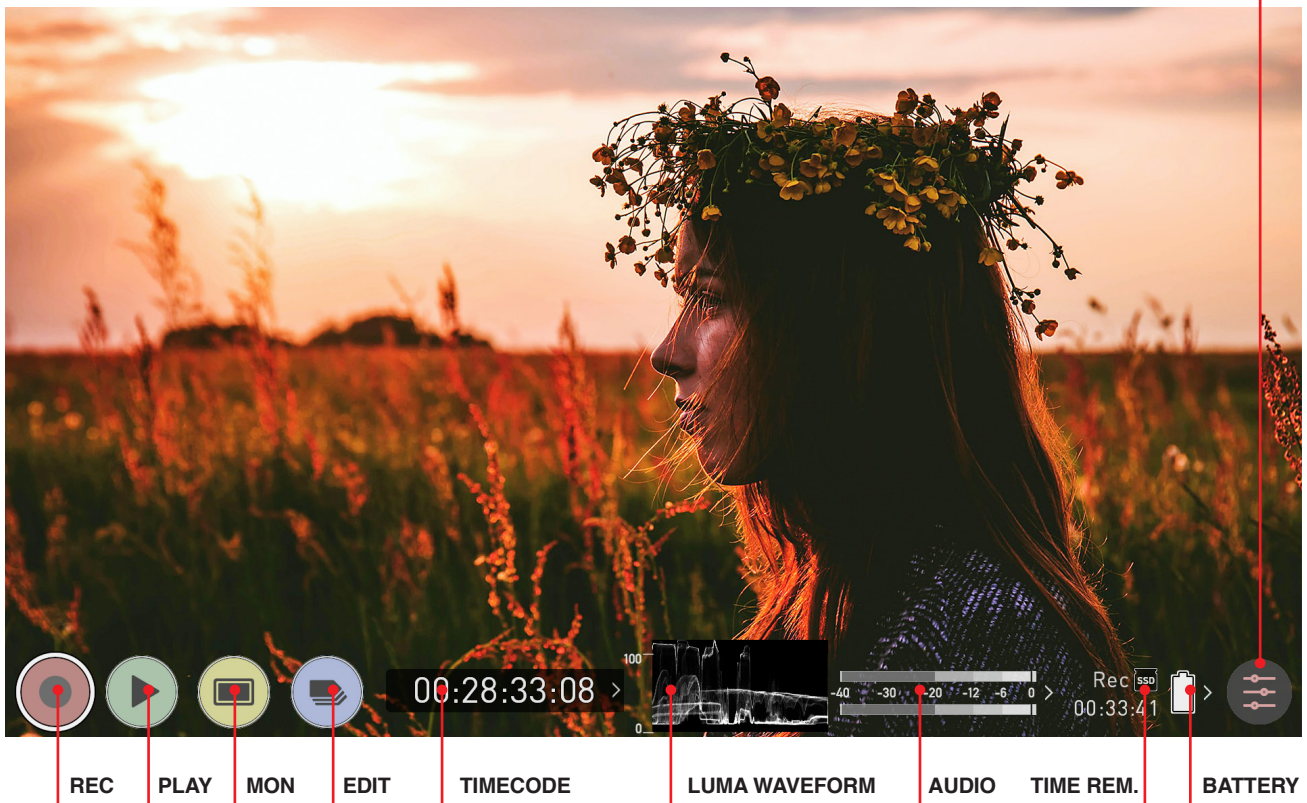

REC (Record):

Press to begin recording. Jump to Record Home Screen.

PLAY:

Jump to the most recently recorded clip on the Playback Home Screen.

MON (Monitor):

Press once to show **Monitoring Features** and **Information Bar**.

See the following pages for activating Monitoring features.

Press again to return to home.

EDIT:

Press to show **Editing Features** and **Information Bar**.

Press again to return.

TIMECODE:

Shows the selected timecode such as embedded, time of day or rec run.

LUMA WAVEFORM:

Luma Waveform is now a constant on your homescreen. Allows for greater control over monitoring without compromising the subject.

AUDIO:

Audio Meters. Touching the Audio meter will open the Audio Menu.

TIME REMAINING:

Time Remaining on Disk (at current record settings). Changing Recording Format will change Time Remaining.

BATTERY:

Touch to access Power Menu. Battery Indicator shows power level and flashes red when power is running low.

SETTINGS (red):

Touch to access all Recording settings, including input, output, file, media, gamma, gamut, and more.

+ **Remove overlays** by touching the center of the screen. Touch again to return.



Touch Monitor (MON) to reveal Monitoring Features and Information Bar. When activated the Monitor button will have two surrounding rings. See The Main Screen - Monitoring Features

7. Using the Ninja V

The Main Screen - Information Bar

At the top of the Ninja V screen is the area referred to as the **Information Bar**. Info here relates to the settings of your input device/camera, Ninja V, media, audio and more. Touching any of these areas will take you to the relevant menu. More info in the Home screen and menu functions section.

The content in the Information Bar is dependent on what mode you are in, for example Recording and Monitoring will display the Video Input type, but if you are in Play mode, Video Input will show the resolution and frame rate of the video clip currently cued or playing.

Monitor Mode / Features

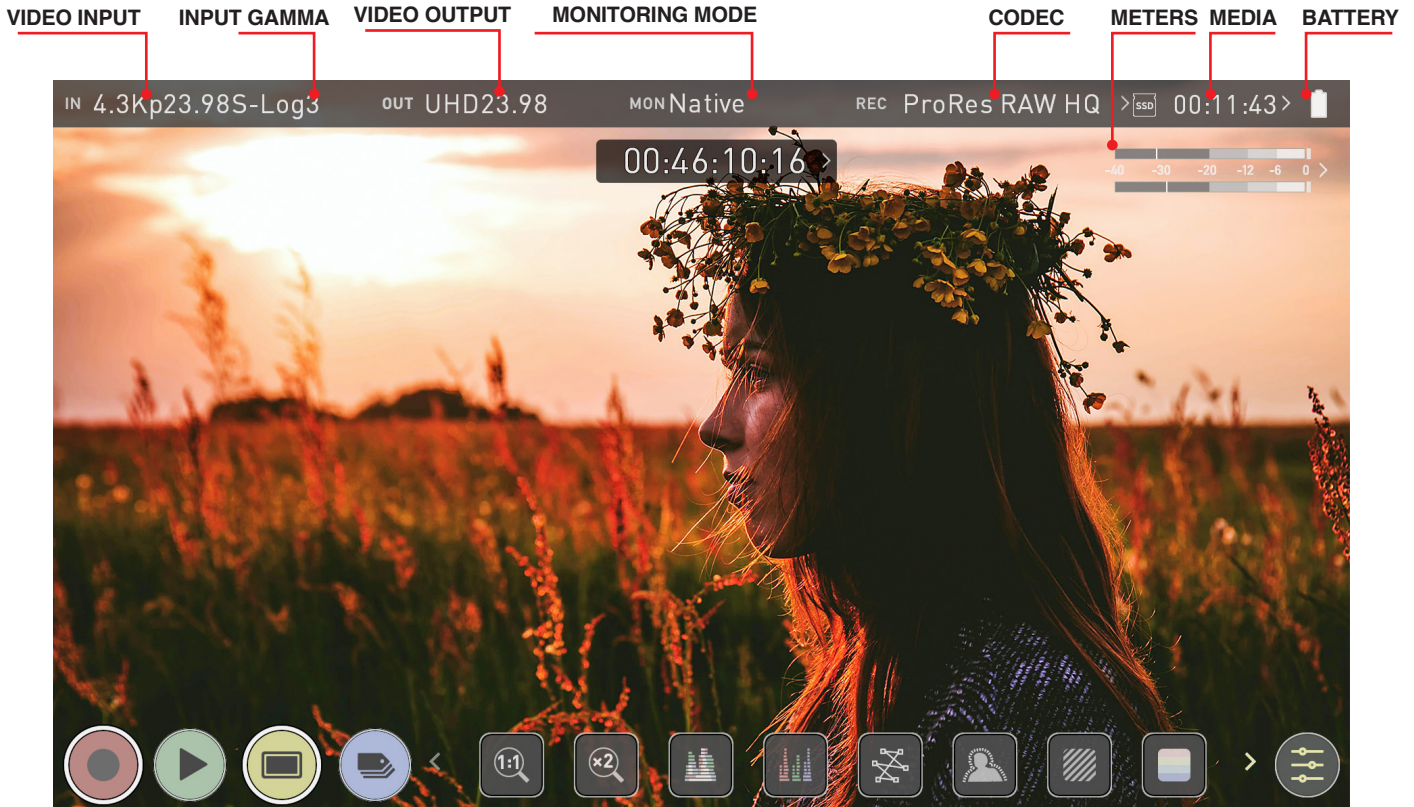

ABOVE: UNIT ENABLED WITH INPUT AND OUTPUT, READY TO RECORD SIGNAL OR PLAY LAST RECORDED FILE FROM DISK

VIDEO INPUT: (Rec & Mon mode)

Resolution and frame rate from input device

VIDEO INPUT: (Play & Edit mode)

Resolution and frame rate of current playback clip

INPUT GAMMA:

Displays the current input gamma. Tap to open Input menu to ensure it matches the output coming from your camera or other input device. RAW inputs will automatically be set to match the camera output. For Sony cameras options can be selected. During playback mode this setting will be determined by the metadata of the recorded content.

MONITORING MODE:

Displays the monitoring display mode that has been selected. Native, Rec709, HLG, PQ or the name of the 3D LUT selected. Touch to change settings.

VIDEO OUTPUT:

This menu displays the active video resolution and frame rate being output from HDMI.

CODEC (RECORDING FORMAT):

Shows the recording format. Touch to change settings.

METERS:

Audio Meters. Touching the audio meter will open the Meters Menu

MEDIA INFO:

This shows the remaining recording time based on the chosen codec and remaining capacity of the drive.

BATTERY:

Touch to access Power Menu. Battery Indicator shows power level and flashes red when power is running low.

SETTINGS (yellow):

Touch to access Monitoring Feature settings.



Touch MON again to return to previous screen.

You will find the EDIT button works in a similar fashion, and that it is not possible to have Monitor and Edit active simultaneously.

7. Using the Ninja V

The Main Screen - Monitoring Features



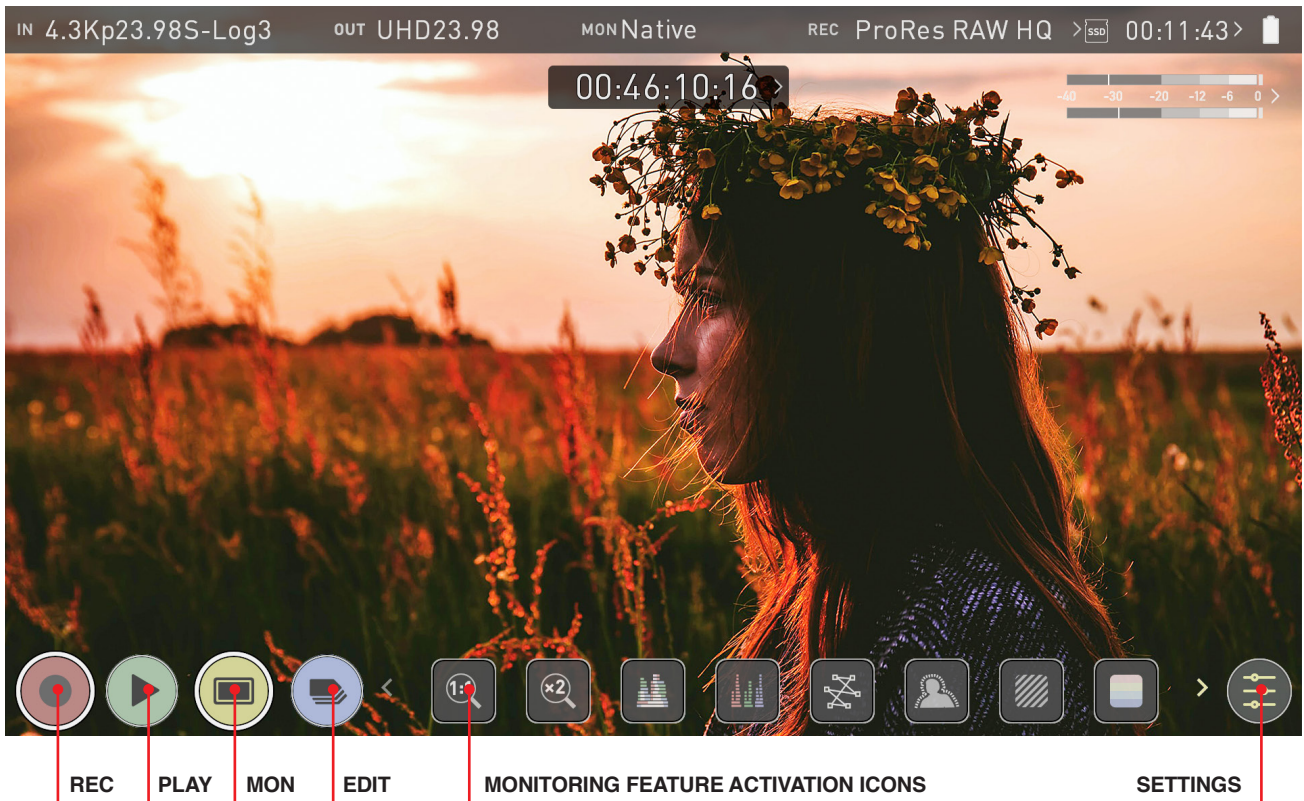

At the bottom of the Monitoring screen are the Monitoring Features, accessible by toggling the MON icon. Monitoring Features do not affect your recorded file and can be turned on and off, or adjusted whilst recording (unless you choose to burn a LUT into your footage). Not all Monitoring

features are available at first glance – to reveal all Monitoring features, swipe monitoring icons to the left. The icons will behave in a carousel like manner and you can swipe left and right to access any of the features. At the bottom right is the Settings button. Press Settings to adjust behaviours of Monitoring Tools.

Monitor Mode / Features



Main Controls

- 
REC (Record):
 Press to begin recording. Jump to Record Home Screen.
- 
PLAY:
 Jump to the most recently recorded clip / Playback Home Screen.
- 
MON (Monitor):
 Whilst on the monitoring features screen press once to revert to home screen view. For Monitor settings press the Settings button. Any Monitoring functions you have enabled will remain active until deactivated.
- 
EDIT:
 Press to show **Editing Features** and **Information Bar**. Press again to return to home. Any Monitoring functions you have activated will remain active until they are turned off.
- 
SETTINGS (yellow):
 Touch to access Monitoring Feature Settings. Set scope sizes, adjust transparency, LUTs, Focus Peaking and more.

Monitoring Feature Activation Icons:

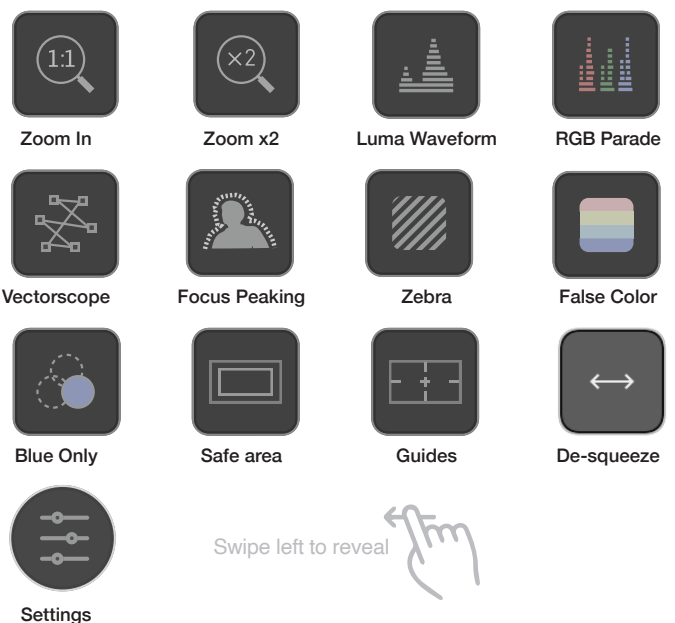

7. Using the Ninja V

Home screen and menu functions

REC (Record)

This is the icon you touch to begin a recording. Touch it again to stop a recording. While recording the Rec icon changes to a Stop icon and a red frame is present around the screen.

Standby

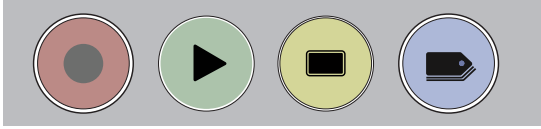

Recording

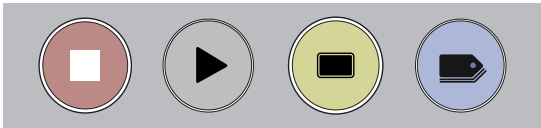

No input / No media

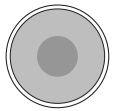

 The Rec icon is dimmed and disabled if there is no valid video input. It also appears in situations where there is no media, the disk is not formatted or the disk is full. The button is dimmed because you cannot record.

PLAY

Touch this icon to play previously recorded clips and touch it again to pause playback. When you press the green Play button the Ninja V will switch to playback mode and automatically play the last recorded clip.

Playback mode

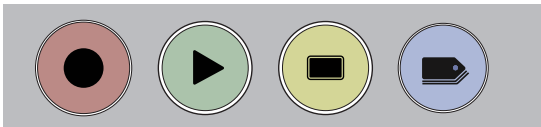

Playback Home screen



Touching the folder icon will reveal the available playlist. See next image.



Ninja V uses a unit name, scene, shot and take convention to name the clips. Select the clip you want to play by touching the file name and this will start to playback. To exit the playlist simply touch close, or any other button. Touching close will take you to the previous window.



Close playlist



folder level up



Playlist options

No disk / disk not secure



The Play button will be dimmed and disabled if there is no disk, where there is a poor connection or the disk is not correctly formatted and during recording. See the [Format Media Section](#)

MON (Monitor)

Pressing MON reveals Monitor Assist icons as shown on previous page. These features are explained in detail in the Monitoring Features section.

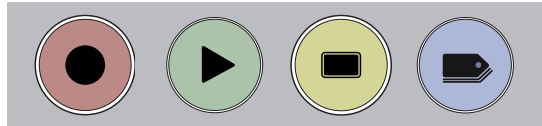

EDIT

You can use the edit tools during recording and playback. Pressing EDIT takes you into a number of options which will be explained later.

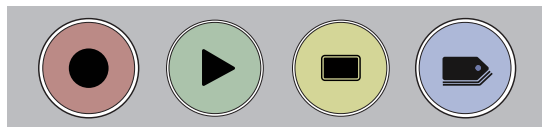

7. Using the Ninja V

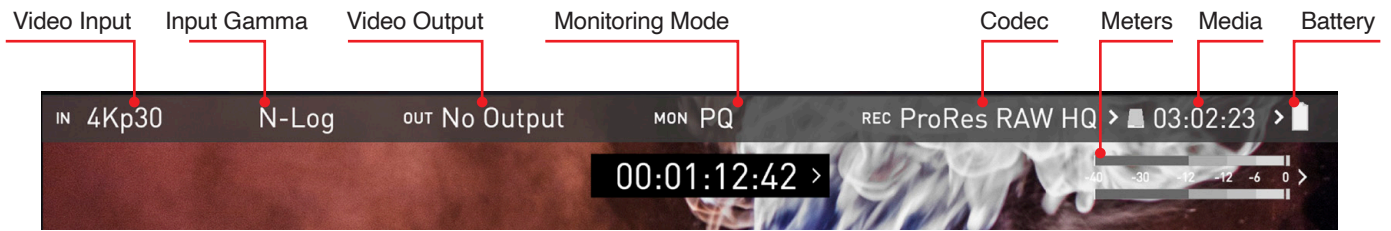

Information Bar - Adjust your settings

The **Information Bar** of your Ninja V displays the settings of your input device/camera, current settings of your Ninja V, media, audio, disk capacity and more. Touching any of these areas will take you to the relevant menu and allow you to make changes to your setup.



Alternatively you can access these settings by tapping the Record Settings icon. Tapping the Settings button will open the Record Settings menu, from where you will be able to navigate to the required tab. Swipe left to see more tabs.



If you power on Ninja V after using the AtomX CAST mode, you may see a warning notifying you that an AtomX CAST module has not been detected. You will be advised to Power Off your Ninja and attach the module, or to change modes and operate without the module.

Input Video Input

Simply tap the source input menu to the top left of the screen to bring up the input control panel. This panel is a command center for all devices connected to the Ninja V and will assist you with connectivity by indicating if the signal is active or if attention is required.

Source Source

The Source menu allows you to select your Input Source from the following:

HDMI

Selects the HDMI input on your Ninja V. This mode should be used for standard Ninja V operation when you do not have AtomX CAST connected. Selecting HDMI whilst in AtomX CAST mode, will reboot Ninja V in HDMI mode.

AtomX SDI Module

For SDI sources connected to an AtomX SDI Module that is attached to your Ninja V. To be available for selection, an AtomX SDI module needs to be connected before turning on the Ninja V.

AtomX CAST

Select to use the features of the AtomX CAST. To be available for selection, the AtomX CAST module needs to be connected to the Ninja V before powering it on.

Once you have selected an input source, tap OK and your Ninja V will power down and reboot in the selected mode. Press cancel to return to the selection screen.

When AtomX CAST is connected to your Ninja V, the AtomX SDI option will be greyed out since you cannot use the SDI module when the AtomX CAST is attached.

RAW inputs are not supported when using the AtomX CAST for switching.

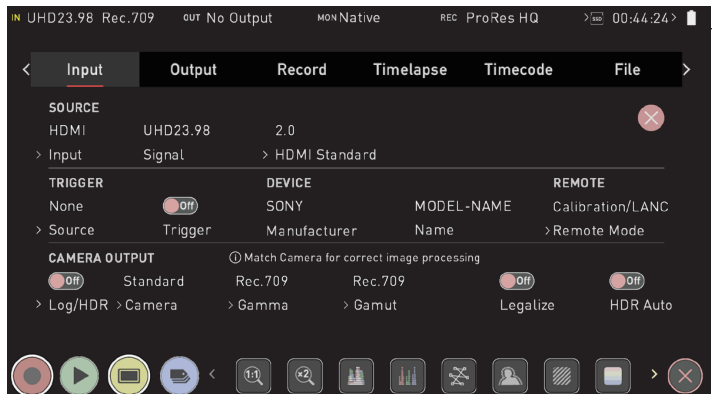

SOURCE

Input

When you have an AtomX SDI module attached to your Ninja V, you will be able to tap on Input to switch between HDMI and SDI inputs.

Signal

The resolution and frame rate of the selected input source is displayed. No Input will be displayed when there is no input connected.

HDMI Standard

When connected to an HDMI source, tap on HDMI Standard to toggle between 1.4, 2.0 and Compatibility Mode.

Compatibility Mode (HDMI)

This mode improves the signal locking process when working with HDMI signals from specific cameras. After selecting compatibility mode, remove and re-insert the HDMI cable to the camera.

7. Using the Ninja V

 Compatibility mode should be enabled when recording from a Z CAM E2 series camera via HDMI, for all frame rates and resolutions in ProRes, DNx and ProRes RAW.

 Compatibility mode should be enabled when recording video from a Canon 1DX III via HDMI, in 4Kp50 and 4Kp60 modes in ProRes and DNx.

 Compatibility mode for HDMI should not be used for any HDMI RAW signals except for Z CAM E2 series cameras and the Canon EOS R5.



Input

AtomX SDI Expansion Module

The AtomX SDI expansion module adds 12G SDI I/O to your Ninja V with 2 x industry standard full size BNC connectors.

Once you have connected the AtomX SDI module to your Ninja V, the unit needs to reboot before you can use the module.

On the Input (IN) menu page in the 'SOURCE' section, tap Input to switch from HDMI to SDI. You will then be prompted to reboot your Ninja V so that it can change to the SDI input. Tap Confirm and wait for your device to reboot in SDI source mode.

Once in this mode, the input menu will resemble the image shown above.

The AtomX SDI Module does not need to be activated before use, however to use the SDI RAW feature you will need to activate this feature. Refer to the Activation section for more info.

 You can only switch from HDMI input to SDI input when the AtomX SDI Expansion Module is connected to your Ninja V.

 To use the AtomX SDI Module with your Ninja V, firmware version 10.1 or later needs to be installed. To use SDI RAW, firmware version 10.6 or later needs to be installed.

Mode

When connected to an SDI source, tapping on Mode will toggle between the following modes:

- **Single Mode**
For single SDI sources, where a single SDI input on either the Channel 1 or Channel 2 connector.
- **Dual Mode**
Selects both SDI connectors to deliver the input signal as a dual-link connection, where two SDI cables are connected for dual link 1.5G/3G and 6G standards.

- **Auto Select**

Your Ninja V automatically detects the correct mode to use, based on the signal that it is receiving.

Channel Source / Link Status

In Single Mode, a Channel Source indicator will appear and display the currently selected channel. Where you have two different SDI sources connected, you can tap Channel Source to switch between SDI connector 1 and 2. Single link SDI connections will automatically be configured based on the signal input between 12G/6G/3G/HD.

In Dual mode, a Link Status Indicator will display the status of your signals. Channel 1 and/or 2 will be red when the signal is not present, whilst they will both be green when both receiving a signal.

Compatibility Mode (SDI)

Where SDI has been selected as your input, a Compatibility Mode toggle switch will be visible under Source. This mode improves the signal locking process over SDI, when working with specific cameras that use a slightly different version of the 12G standard. For more information refer to atomos.com/support.

Input

TRIGGER Source

The Ninja V can be remotely triggered to record from your camera. For HDMI inputs, tap Source to select from the following trigger sources:

- **HDMI**
If HDMI timecode is selected, you have the choice to start and stop recording remotely from the source camera timecode.
- **None**
Select to disable the record trigger.
- **Timecode**
For older cameras or cameras that don't have Start/Stop flags for triggering recording, the rolling timecode trigger will trigger recording automatically on the Ninja V when it detects rolling timecode on the camera.
- **Camera Manufacturer**
When you have an AtomX SDI module attached, and have selected SDI at Input, you will be able to tap Source to cycle through camera manufacturers as well as Timecode or None as the source of a trigger.

Trigger

Where you have selected Timecode as the trigger source, you can enable or disable the trigger by tapping the ON/OFF switch.

7. Using the Ninja V

DEVICE

- **Manufacturer**

Displays the camera or device manufacturer.

- **Name**

HDMI Devices will display an EDID Device name if the information is available from the HDMI device connected. Not all cameras carry an EDID device name. For cameras such as the Panasonic LUMIX GH5 this will display as 'Unknown'.

 Note that where you have selected a camera manufacturer, you cannot disable the trigger

REMOTE

Remote Mode

- **Camera Controls**

Allows you to control supported cameras via the screen of your Ninja V. Refer to AtomOS Camera Menu Control for ZCAM Series cameras section below.

- **Calibration**

Every brand of monitor in the field and in the editing suite naturally drifts in color over time. Atomos have partnered with calibration leader Calibrite to open up professional monitor calibration to all filmmakers. For information on how to calibrate your Ninja V, visit <https://www.atomos.com/accessories/x-rite-i1-display-pro>

- **Lanc**

For remote operations via the Remote/Calibration Port, AtomOS supports both LANC in Sony and Canon format. The Ninja V uses LANC Client so a LANC controller must first be attached to a camera and the output connected via a Y cable to the Ninja V.

AtomOS Camera Menu Control for ZCAM Series cameras

When using your Ninja V with ZCAM E2 series cameras, you can control your camera via the screen of your Ninja V.

To use your Ninja V for control of a ZCAM camera, use an HDMI cable that supports 4Kp60 to connect the output of the ZCAM to the HDMI input of your Ninja V. Connect the 3.5mm end of an Atomos USB-C to Serial LANC cable to the Remote/Calibration Port on your Ninja V, and the USB-C end of the cable to the USB Type-C port on the ZCAM.

 RAW over HDMI must be disabled for camera menu control to work.

Power on your ZCAM and navigate to RAW over HDMI in the Record menu, to ensure that it is turned off.

Power on your Ninja V and select Compatibility Mode in the Input menu at HDMI Standard. Remove the HDMI cable from the ZCAM and re-attach it to ensure that the signal is locked correctly.

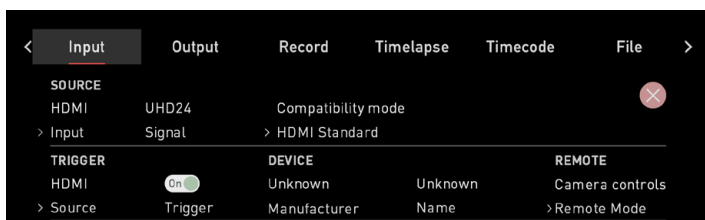

Tap on Remote Mode on the Input page to select Camera Controls, then tap on the blue Camera icon on the bottom of the screen.

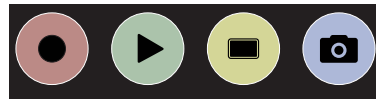

Your Ninja V will display the ZCAM camera settings and a camera battery status icon across the top of the screen, with audio meters and a Menu icon on the right hand side. The information that is normally displayed across the top of the screen like video input, media, timecode and battery status will now be displayed on the bottom of the screen.



On this screen you can manually adjust the settings of your ZCAM from your Ninja V. Tap one of the settings across the top of the screen like aperture, shutter speed, ISO or WB to bring up the adjustment arrows below the selected setting. Tap on the left or right arrow to adjust the values for the setting.

When you adjust the settings for ISO or WB, an additional Auto ISO or Auto WB icon will appear on the right side of the screen. If you tap on this icon, it will enable the automatic ISO or automatic WB mode respectively. The icon will have a white border, and an 'A' will be displayed beneath ISO or WB when enabled. Tap the icon again to disable the automatic mode.



Tapping on the Menu icon on the right side of the screen will bring up some icons that replicate the physical buttons on the top of the ZCAM. The operation of these buttons are the same as the physical buttons.



Tap on the Menu icon to bring up the ZCAM menu on your Ninja V screen. This is the same menu that appears on the screen of the ZCAM when you press the physical Menu button on the ZCAM.

You can now use these icons to navigate through the ZCAM menu system and adjust settings, the same way you would when using the physical buttons on the ZCAM.

7. Using the Ninja V

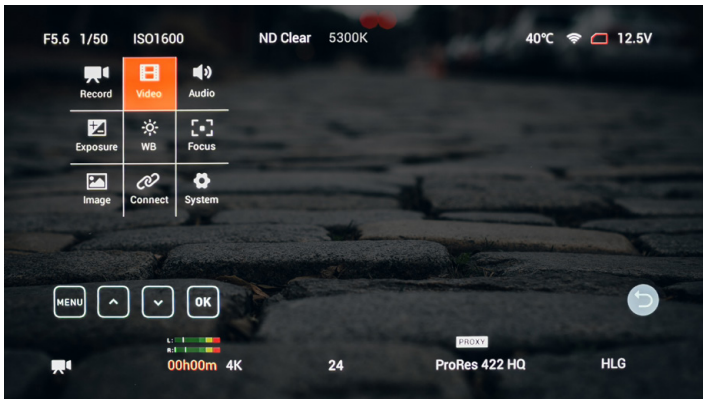

Tap on the Menu icon again to hide the menu, and tap on the Return arrow icon on the right side of the screen to return to the previous screen.

CAMERA OUTPUT

For the best image processing results it is essential to match the Ninja V settings to the camera/input settings. Choose to use Log/HDR, camera type, Gamma, Gamut or enable HDMI HDR auto if required. Your Ninja V will recognise most cameras when correctly attached via a compatible HDMI cable.

Log/HDR: Turn on to enable HDR image processing inside the Ninja V. Bring the control of post into your shoot - record, preview and review using HDR.

Camera: Tap to scroll through to the manufacturer of the camera providing the input. Sony, Fujifilm, Canon, Panasonic, ARRI, RED and JVC.

Gamma: For each manufacturer there may be a number of different Log curves available and you can scroll through to the correct selection by tapping the Gamma icon.

Gamut: Select the Color Gamut of the input. This is not applicable to all cameras but again ensure that this matches the input of the camera to ensure accurate monitoring.

Legalize: The legalize function allows you to convert a full range video signal into a legal range signal to suit legal range NLE editing workflows. This setting is designed for use with inputs in SDR or REC709 that are set to or are fixed in FULL range, but recording or monitoring is needed in 'legal range'. The terminology used by manufacturers when referring to levels can vary, but all refer to the range of values contained within an image file:

Full / Data / Extended	0-255 (8-bit)	0-1023 (10-bit)
Legal / Video / Limited	16-235 (8-bit)	64-940 (10-bit)

If you are working in SDR/Rec709 and have a full range video signal coming in, it is best practice to turn the Legalize function ON, on your Ninja V. For Log inputs, the conversion to LEGAL range should NOT be applied. Log outputs from the cameras utilize FULL range signals in order to gain the maximum level of data and preserve dynamic range. The majority of Log base workflows are derived from Cineon, Kodak's original Cineon Film DI system. E.g. Sony, Canon and Panasonic all use FULL range levels.

⚠ Do not apply the Legalize function to a LEGAL range signal as this will create an incorrect correct color pipeline. The result will create an image that is of lower contrast and look like Log but without the additional dynamic range of Log - as the camera output was already defined as a Rec.709 / BT.1886 gamma.

🚩 The legal range toggle is not available when using Atom HDR. Atom HDR is used for log workflows and when engaged the Legalize option will not appear.

🚩 The legalize option is not available for ProRes RAW video.

HDR Auto

HDR is detected when there is a compatible input signal. It is important that this is OFF if the camera is not outputting HLG or PQ. It should not be used for regular Log.

About Log/HDR

A better understanding of Log and HDR will enhance your workflow and ultimately allow you to capture maximum amount of detail during recording, and save you time in post production.

To understand more about the importance of this function please refer to the Understanding HDR and Log section.

Cross Conversion

When an AtomX SDI Expansion module is attached to your Ninja V running firmware version 10.6 or above, you can cross convert HDMI and SDI signals. Cross conversion happens automatically, and does not need to be enabled.

This means that where you have an HDMI source connected to your Ninja V, you can output an SDI signal from your AtomX SDI Expansion module. In this scenario, both BNC connectors on the module can be used for two simultaneous SDI outputs, which allows you to output the same signal to two monitors.

Where an SDI video signal is connected to your AtomX SDI Expansion module, you can output an HDMI signal over the HDMI out on your Ninja V.

🚩 Cross conversion of SDI RAW video inputs is possible, once your Ninja V has been activated for RAW at my.atomos.com

Whilst converting the signals listed above, you can use the Output Options in the Output menu to downscale and crop the signals. The HDR section provides options for outputting HDR versions of the signals after cross conversion.

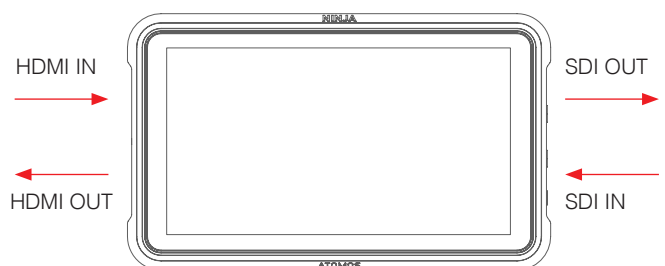

7. Using the Ninja V

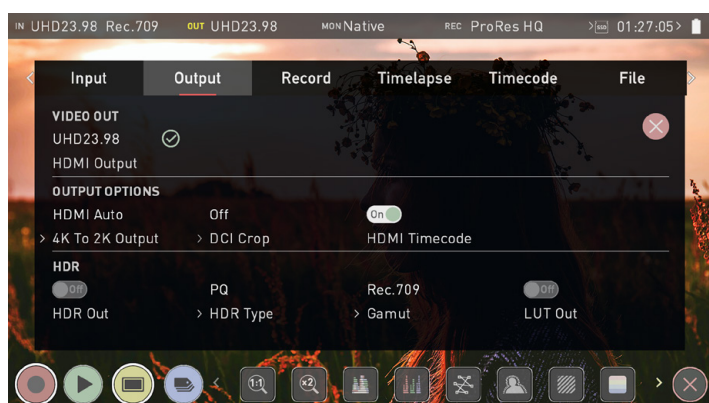

Output

Output

This menu displays the active video format being output over HDMI, or SDI when the AtomX SDI module is attached. A 4K to HD down conversion can be applied to the output, which allows you to send a 4K input signal to a HD device. When working in HDR a signal will be output with the HDR flag to activate the correct settings on a compatible HDR display. This can be useful if you wish to monitor log footage in the studio.

VIDEO OUT

This option will show the resolution of the Input. When processing options are applied below it will be adjusted accordingly.

HDMI Output

Displays the resolution and frame rate of the HDMI Output from your Ninja V.

SDI Output

Appears when you have an AtomX SDI Module connected, and displays the resolution and frame rate of the SDI Output.

OUTPUT OPTIONS

4K to 2K Output

Allows you to scale 4K or UHD inputs for output. This will scale 4K to 2K and UHD will be scaled to HD 1080p.

DCI Crop

When enabled, this setting trims the 17:9 DCI input to 16:9 converting the signal to UHD. When 4K to 2K Output is On, the output will down scale to HD.

HDMI timecode

Allows for the embedded timecode or in unit generated timecode to be looped out. The option is present to allow you to turn the timecode as this can disrupt some consumer equipment that is not intended to receive embedded timecode.

HDR

Here you are able to set a conversion from your LOG input to a HDR display standard such as HLG or PQ. You can also define the output color gamut from your camera's gamut to a display standard for BT2020, DCI-P3 or Rec709.

HDR Out

Enable or disable HDR on the output.

HDR Type

Allows you to select the HDR type to output. Tap to cycle through PQ, HLG and Dolby Vision Tunnels.

Gamut

Allows you to select the Gamut of the signal that is output. Tap to cycle through Rec.709, BT.2020 and DCI-P3.

LUT Out

Allows you to loop out LUTs that are applied to your image, so that they are also applied to the Output signal.

7. Using the Ninja V



Output

AtomX SDI Expansion Module

SDI Output: In the VIDEO OUT section of the Output menu page, the SDI module will automatically detect the resolution and frame rate of the SDI input when connected. The Ninja V detects the active input Channel Source and configures the other connector as an Output.

SDI 3G Type: Allows you to specify the 'SDI 3G Type' for compatibility with equipment that expects a specific type of 3G-SDI video. Tap to cycle through the options: Level A, Level B or Auto.



You can only output SDI when the INPUT is in 'SINGLE' or 'AUTO SELECT' mode.

SDI Compatibility Mode

Some video devices use a slightly different version of the 12G standard, which can cause issues with their ability to detect a video signal that is output from an Atomos device. Enabling SDI Compatibility Mode will cause your Ninja V to send out a video signal in the format that these devices expect. Tap the switch to toggle between On and Off.



Record

Record

Space Remaining

Indicates the expected recording time remaining on the inserted HDD/SSD media at the current settings. Changing your recording settings may extend or decrease your available recording times.

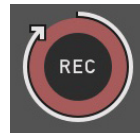

Pre-Roll

With this option turned on you will see a red Pre-Roll icon flash in the top left hand corner and a white circular arrow around the record button. Whilst enabled, the input has constantly been recorded with approximately the last 8 seconds in HD and 2-3 seconds in 4K being cached into memory. The frame rate and codec selected will determine the number of seconds being cached for Pre-Roll. Using a lower bit rate codec setting and shooting at a lower frame rate will increase the length of Pre-Roll.

When the record button is pressed or trigger is sent, the buffered Pre-Roll data in memory will be written out to the start of the recording. This means if you are a few seconds slow hitting the record button when something interesting happens you will still capture the shot.



With Pre-Roll mode activated the Recorder is constantly caching frames internally to the unit and as such any feature that can not be changed whilst recording is disabled. This includes audio channel select, 3D LUT record, codec, disk options etc.

CODEC (Recording Format)

Codec Format

To select a codec tap on the currently displayed codec to toggle between Apple ProRes®, Apple ProRes RAW, Avid DNxHD® and H.265. After selecting a codec, you will be prompted to tap Confirm to switch to that codec.

If you select an optional codec like Avid DNx, ProRes RAW or H.265, you will be prompted to activate the codec at my.atomos.com as these codecs must be activated before use.

7. Using the Ninja V

Compression

Tapping on this setting allows you to toggle the compression for the currently selected codec.

Apple ProRes is built in to the Ninja V and offers three levels of compression (HQ, 422 & LT). Avid DNx requires activation via my.atomos.com and includes DNxHD with four levels of compression (220x, 220, 145, 36) and DNxHR for 4K/UHD inputs with four levels of compression (HQX, HQ, SQ and LB). DNxHD 220x/DNxHR HQX are 10-bit, whilst all others variants are 8-bit and DNxHD36 is a proxy codec.

Apple ProRes RAW also requires activation via my.atomos.com and includes two compression options: ProRes RAW and ProRes RAW HQ. Compression artifacts are very unlikely with ProRes RAW, and extremely unlikely with ProRes RAW HQ.

H.265 (HEVC) is an optional paid activation via my.atomos.com and provides three compression options HQ, MQ and LQ (High Quality, Medium Quality and Low Quality).

Record Format

Displays resolution and frame rate that is being recorded to your HDD/SSD.

Record Bit Depth

When the H.265 codec is selected, an additional Record Bit Depth setting will be available on the Record page. Tap to cycle through the options which include 8-bit 4:2:0, 8-bit 4:2:2 and 10-bit 4:2:2.

ProRes Avid DNxHD® **ProResRAW** **H.265**

RAW over HDMI

When connected to a supported camera via HDMI, you will be able to record RAW data over HDMI. When RAW over HDMI is enabled on a connected camera, your Ninja V will automatically detect the RAW signal and prompt you to select ProRes RAW as the recording codec.

 Refer to the documentation for your camera on how to enable RAW over HDMI from the camera.

SDI RAW

You can add the SDI RAW feature to your Ninja V by purchasing the optional SDI RAW upgrade at my.atomos.com.

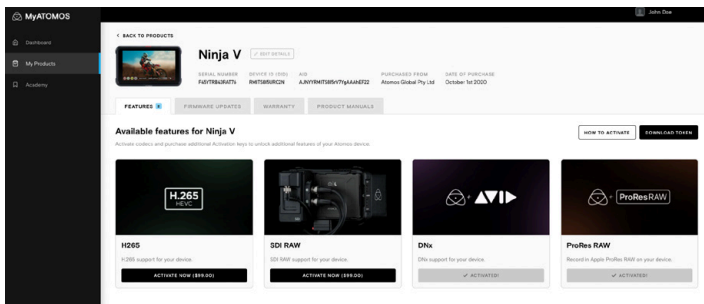

After activating the feature on your Ninja V, you can use the AtomX SDI Expansion module to record RAW over SDI from compatible cameras. Refer to Activation section for more information on the activation process.

 When RAW over SDI is enabled on a connected camera, your Ninja V will automatically detect the RAW signal and prompt you to select ProRes RAW as the recording codec.

 To use the AtomX SDI Module for SDI RAW, firmware version 10.6 or later needs to be installed on your Ninja V.

H.265 (HEVC)

You can add the H.265 (HEVC) codec to your Ninja V codec options by purchasing the optional upgrade through your my.atomos.com account.

Refer to the Activation section for more information on my.atomos.com and the activation process. Once the upgrade is purchased and has been installed, you can select H.265 as a recording codec on the Record page.

The H.265 codec is a highly efficient compressed codec that combines excellent image quality with a small file size, which makes it ideal for streaming and for the sharing of files. It is also well suited to situations where there is no time or budget for color grading, as you can 'bake in' Rec. 709 or a custom LUT to the file so that you can share files immediately at the end of a shoot.

H.265 is also an excellent option for recording high quality proxy files in an ARRI or RED SDI workflow, where RAW is being recorded internally on the camera. Your H.265 proxy recordings can also use the same file names as the RAW files, so that you can start editing with the proxy files immediately and then use the RAW files for the final color grade.

For information on using Red/Arri file names for your recordings, refer to the File Naming section.



Record

PULL DOWN

Pulldown Format

The record menu allows you to apply pulldown removal if recording from a source that applies pulldown to the output signal. Tap Pulldown Format to cycle between the options. Note for 3:2 Pulldown removal, movement in the frame may be required to accurately lock signal, simply wave your hand in front of the camera to achieve lock.

PULLDOWN

HDp29.97

> Record Format

What is Pulldown?

Many professional and consumer cameras available today do not send true 1080p24, 1080p23.98, 1080p25, 1080p29.97 or 1080p30 signals to their HDMI outputs.

Instead they send 1080i59.94 in NTSC regions (e.g. USA, Japan), and 1080i50 in PAL regions (e.g. Europe)

In order to convert the signal from the internal recording format to 1080i5994 or 1080i50, they use a process called 3:2 or 2:2 pulldown.

7. Using the Ninja V

 *Pull-down is only applicable to interlaced HD signals, not 4K*

Camera Setting	Pull-down	Ninja V Receives
1080p23.98	3:2	1080i59.94
1080p24	3:2	1080i60
1080p25	2:2	1080i50
1080p29.97	2:2	1080i59.94
1080p30	2:2	1080i60

You will of course want the Ninja V to record the actual frame rate such as 1080p23.98, not the 1080i59.94 to disk. In many cases, it is not possible for the Ninja V to detect when pull-down has been applied to the video, so you will have to set the correct mode of removal on the Ninja V to match the setup of your camera.

With some cameras, the Ninja V can detect and remove the pull-down automatically, in which case the mode you expect (e.g. 1080p23.98) will display on the Ninja V and you will not have to do anything further.

If there is no input detected, then toggle the input by pressing the screen until you see the input you wish to record.

 *Atomos is adding auto-detection support for more cameras, please check for firmware updates regularly at www.atomos.com*

VID HDp23.98

1080p23.98 or 1080p24

If you have set 1080p23.98 or 1080p24 in your camera and your Ninja V displays 1080i59.94 or 1080i60, then you can easily remove the pull-down by following these steps:

- Select the Input Menu from the top Left and toggle the blue arrow underneath Record repeatedly until you see 1080p23.98 (or 1080p24) displayed. You may not get a green tick in this column immediately.
- Your Ninja V needs to analyze the video for about 1 second, in order to detect the pull-down sequence and remove it.
- If it is not automatically detected after 1 second, wave your hand from side to side in front of the lens, or wave the camera from side to side for a few seconds. The Ninja V will detect the pull-down cadence in the movement, and you will see a green tick along with the video displayed on the screen.

 *3:2 pull-down detection is difficult, it is not impossible to detect on completely still video. This is why you should wave your hand in front of the lens.*

 *If you lose the input detection – for example you unplug the HDMI cable or go to Playback mode, you will need to wave your hand or the camera again, when the signal is restored to the Ninja V.*

 *Some cameras use a variant of pull-down removal, for example Panasonic Advanced pull-down. The Ninja V does NOT support this format, and it will not be detected.*

 *Standard Panasonic pull-down is supported, ensure in the Panasonic camera settings that pull-down is not set to Advanced.*

1080p25, 1080p29.97 or 1080p30

For these modes, access the Record Menu tab and simply press the Record Format options repeatedly until your 1080p desired format is displayed. There is no need to wave your hand or the camera, as 2:2 pull-down removal does not require moving video.

7. Using the Ninja V



Record

Sony Metadata Crop

To help with your video editing workflow, you can crop the RAW video captured from certain cameras like the Sony Alpha A7sIII, Sony Alpha 1 and Sony FX3 when recording ProRes RAW.

So for example, when recording 4.2K ProRes RAW video on the A7sIII the resolution is 4264 x 2408. Using the metadata crop feature will allow you to record the signal as 4240 x 2385, which has an aspect ratio of 16:9. This means that you can use the 4.2K footage in a 16:9 timeline in your NLE without having to be concerned whether the scaling of the image is correct.

Sony Metadata Crop will appear in the Record menu, when you have an HDMI RAW video signal that supports this feature and ProRes RAW is selected as the recording codec.

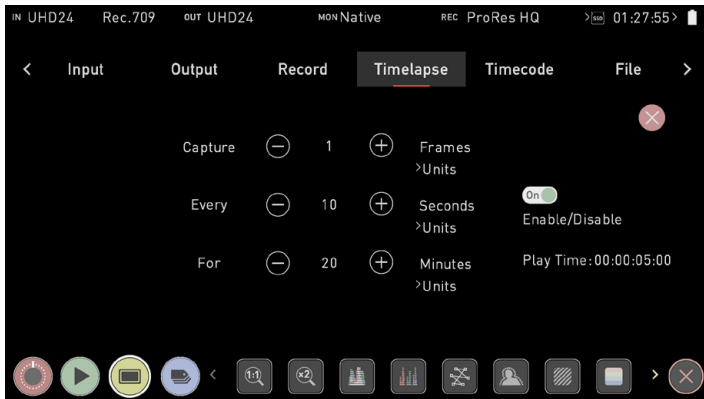

Timelapse

Timelapse

This menu allows you to set up recording of a timelapse sequence as a single video file in ProRes, DNx or ProRes RAW from HDMI or SDI source.

Timelapse sequences are used to create dynamic videos showing changes in light or movement in a scene over time. Images are captured at set intervals like 1 frame every 10 seconds and saved to the video file in sequential order, so when the timelapse video is played back at a frame rate of 24 frames per second, time is compressed and the changes in the scene appear more pronounced.

Examples of this are timelapse recordings of a sunset or sunrise, or the construction of a building.



Capture X frames / seconds

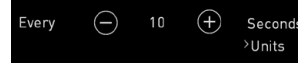

Every X seconds / minutes / hours



For X frames / seconds / minutes / hours

Use the + and - icons to adjust the amount of frames to capture, interval at which to capture them and total length of time to record the time-lapse.

These options allow you to specify the settings of the time-lapse in the following way, where 'X' is your numerical setting:

An example of common time-lapse settings might be as follows: capture 1 frame every 10 seconds for 20 minutes.

Note that if you select multiple frames/seconds to be captured in the first setting in the example above, these frames/seconds will be captured sequentially. So if you select 15 frames here, it will capture 15 frames as a block every 10 seconds for a duration of 20 minutes.

As you adjust these settings, the Play Time in the bottom right updates to let you know the duration of the final video based on your settings.

When you are ready to begin your time-lapse recording, tap on the Enable/Disable toggle.



The REC button will then change to the time-lapse REC button, provided that you have an input connected and media inserted.

This allows you to check whether you are in the standard record mode or the time-lapse record mode at a glance. Tap on the time-lapse REC button to begin recording. Your Ninja V will record the time-lapse sequence as a single video file, using the codec and compression settings selected on the Record page.



The following icon will appear in the top right corner of your screen to indicate that a time-lapse is being recorded.

Note that the pre-roll feature is not supported when using time-lapse.

When you have finished using the time-lapse feature, make sure that you use the Enable/Disable toggle to disable the time-lapse recording feature to return to regular video capture mode.

If you want to stop the time-lapse recording before the set duration finishes, simply tap on the stop button.

During a time-lapse recording, the length of time that you have been recording will be displayed in the upper right corner of the screen. The timecode will display the actual number of frames captured.



7. Using the Ninja V



Timecode

Timecode

Using Timecode

The timecode display changes position depending on the screen mode you are using. In monitoring mode it appears in the center top, below the info bar. In home screen mode the timecode display sits on the bottom near the REC PLAY MON EDIT icons.

Touching the Timecode display on the home screen, just below the information bar will take you to the Timecode setup screen.

00:00:15:00

The Timecode modes supported are:

- HDMI (Embedded)
- Record Run
- Time of Day
- Auto Restart

Cycle through these modes by touching the Timecode Source Selector.

Source

Tap to cycle through the timecode modes:

• HDMI/SDI embedded Timecode

With this setting, the HDMI/SDI input will use the Timecode embedded in the input signal. The controls to adjust the Timecode value are disabled in this menu as you will need to adjust these on the camera. Note that not all HDMI/SDI sources embed Timecode.

• Trigger from HDMI Timecode

If HDMI timecode is selected and the camera is in REC RUN mode, the user has the choice to start and stop recording remotely from the source camera timecode.

To enable rolling Timecode Start/Stop functions, simply set the HDMI Timecode switch to on. When enabled, pressing the camera Record Stop/Start button will make the Ninja V start and stop record simultaneously as the timecode starts and stops.

 *When using the camera in Free Run timecode, the rolling timecode trigger might not work as expected.*

 *Note that whilst camera triggers are also looped out on HDMI not all wireless systems carry the trigger on to other devices so it's worth testing your system before a shoot if you plan to use it in this way to record proxies.*

Time of Day

With this setting, each new clip that is created will contain embedded Timecode starting with the time of day when the recording is started. Please check that Ninja V clock has been set correctly.

This can be set in the *DATE* menu

 *If recording is stopped and then restarted while in this mode, there will be a time gap between the last clip and the next one, equal to the length of time the Ninja V has been out of record.*

 *In Time of Day mode, the controls on the Timecode Setup Screen for adjusting the start-point of the Ninja's Timecode are not available, as the Timecode is set by the Ninja's internal clock.*

Record Run

With this setting you set the starting Timecode for the first clip. The following clips will start at the frame immediately after the out point of the preceding clip. This will continue for all clips that follow. This is also known as continuous Timecode.

Auto Restart

With this setting, the Timecode will be reset to the Timecode you have defined whenever you press record. All your clips will start with this same Timecode.

 *To adjust the Timecode use the "+" and "-" above and below the hour:minute:seconds sections*

Use Drop Frame

Allows you to use drop frame timecode type.

HDMI Out Timecode

Allows you to output the timecode chosen here on the Output of the Ninja.

7. Using the Ninja V



Timecode

AtomX SYNC Expansion Module

The AtomX SYNC module allows wireless timecode sync with cameras, audio recorders, and timecode systems on set. It also has a small battery inside it which acts as a hot swap continuous power battery extender, allowing you to keep your Ninja V running for approximately 5 minutes while you change the main battery.

When you first plug a sync module into your Ninja V you will be prompted to select a region. It is important to select the correct geographical region here as the Sync module adheres to strict guidelines for each region.

Once connected, it is important to use the calibration feature before use. HDMI cameras deliver their video and audio to your Ninja V with a small delay, so calibration is necessary to identify the amount of delay that your camera has and take that into account.

This will ensure that your video, audio and timecode are in sync, especially if you plan to use SYNC expansion modules with multiple Ninja's on a multi-camera shoot.

 To use the AtomX SYNC Module with your Ninja V, firmware version 10.4 or later needs to be installed.

Follow these steps to sync your video, audio and timecode - and repeat for each Ninja V and SYNC module that is connected to a camera.

- Navigate to Timecode menu on your Ninja V.
- Select AtomX Sync as the timecode source.



- Using an HDMI cable, connect the HDMI output of your camera to the HDMI in connector on your Ninja V.
- Using an AUX cable, connect the headphone out of your Ninja V to the mic/line in connector on the camera and press CALIBRATE.
- Your Ninja V calculates frame delays & displays it as shown below.
- Tap ACCEPT to select the calibrated frame delay, and then continue with your setup.

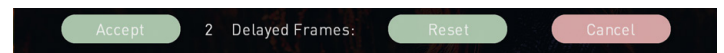

 If you see 'No Audio Detected' on your Ninja V, check the audio settings on your camera and tap 'retry'.

 It's important to recalibrate every time that you change camera type, frame rate or resolution.

7. Using the Ninja V



Sync Config

Sync Config

TIMECODE SYNC

This page allows you to define a network role for each Ninja on the network as either Server or Client, so that Client units can connect to the timecode network created by the Server unit. It also allows you to add other devices like audio recorders to the network via Bluetooth.

Network Role

Tap to cycle between the options to set the network role for the Ninja as either Server or Client. The 'Server' unit will then provide the timecode source for all 'Client' units on the network.

For any other Ninja that you want to sync with, 'Client' should be selected as the Network Role on its Sync Config page. This allows the Client units to connect to the timecode network created by the Server unit.

Start Network

Once you have finished setting up your Server unit, tap Start Network to toggle the Sync network on and off. Note that on Client units you will have a Join Network switch instead of Start Network.

Join Network

When this setting is 'on', the client unit will connect to the Sync Network created by the Server unit. Tap to toggle on and off.

RF Channel

Use the '-' and '+' to select an RF channel between 1-12. Changing the RF channel can help in situations where you are experiencing interference from other devices. Ensure that the RF channel on any Client units is set to the same RF channel as the Server unit.

Record Control

When this setting is enabled, tapping record on the Server Unit Ninja V will cause any other Ninja V or GoPro on the network to start recording as well.

Network FPS

On Client units, Network FPS will be displayed and the frame rate will match the frame rate of the server unit.

Signal

Provides information on the signal strength.

Network ID

Provides information on the Network.

Region

Tap to cycle through the options until you find your region and tap 'confirm' to accept the new region or 'cancel'.

Set Timecode

Press the Set Timecode button to open the Sync Network Timecode page.

Input

Tap to cycle through 'Time of Day', 'Manual' and 'Input'. Select 'INPUT' and tap 'Set Timecode'.

Set Device Name

Tap to change the name of your Ninja V unit. For more information refer to 'b. Unit Name' in 'Using the Ninja V - Best Practice'

BLUETOOTH

You can pair with up to six Bluetooth devices, like an iPhone or a Zoom F6 audio recorder, so that they can connect to the timecode network. A numerical figure will indicate the amount of Free Pairs that are available for Bluetooth pairing. By connecting an Atomos Ultra Sync Blue to the timecode network, you can pair it with Bluetooth devices that are much further away from the AtomX SYNC module. For more information, see www.atomos.com/accessories

Pair

Follow the manufacturers instructions to set up each device for pairing, then Tap Pair to connect to the device. Once paired, the device will be listed in the 'Sync Network' menu page, along with the other connected Ninja V's and other devices.

Unpair All

Tap to unpair all devices that are connected to the timecode network.

 For connected Client units, the timecode source should be set to AtomX Sync on the Timecode page.

 Multiple Ninja V units can be added to the timecode network. Simply repeat this process on each unit.

7. Using the Ninja V

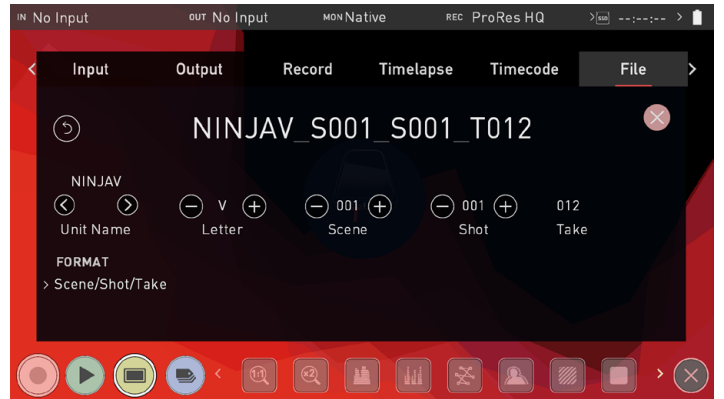

Sync Network

The Sync Network menu page displays all of the devices that you have added to the timecode network. iOS applications like UltraSync Blue Slate, Apogee Metarecorder, Mavis Pro Camera and MovieSlate8Pro that are paired via Bluetooth will also be listed here. With the use of sync products from Timecode Systems, you can also synchronize with a number of other devices like cameras and audio recorders. For more information, watch the AtomX SYNC module video on Atomos Academy at www.youtube.com/watch?v=OkFrIZE_KgQ

File Naming

Allows you to dictate the scene and shot number that will be recorded as well as the ability to change the unit and media name. By default, the unit will be named NINJA V. To change unit name tap the arrow under UNIT/MEDIA NAME, use the left and right arrows to select a letter, and up and down arrows to change its value. Refer to Using the Ninja V - Best Practice for more info. To modify scene and shot number under File Naming, select plus or minus next to scene or shot (up to 999). The number you choose will then be shown in the file name at the top of the screen during recording, the take number is automatically increased with each take.

FORMAT

Tap to cycle through the format options: Rolling scene/shot/take, Scene/shot/take, Red One/Epic, Arri. Selecting Red/Arri file naming here will allow your recordings on the Ninja to use the same name as the files recorded in camera.

 *Red/ Arri file naming is only supported when connecting via SDI to the AtomX SDI Module.*

Rolling filename:

Scene, Shot, and Take file names allow users to accurately name planned shots as if using a conventional slate. Rolling filename adds the ability to maintain continuous rolling file naming and take counts after re-formatting a drive. This function can be turned on or off in the file naming menu.

7. Using the Ninja V

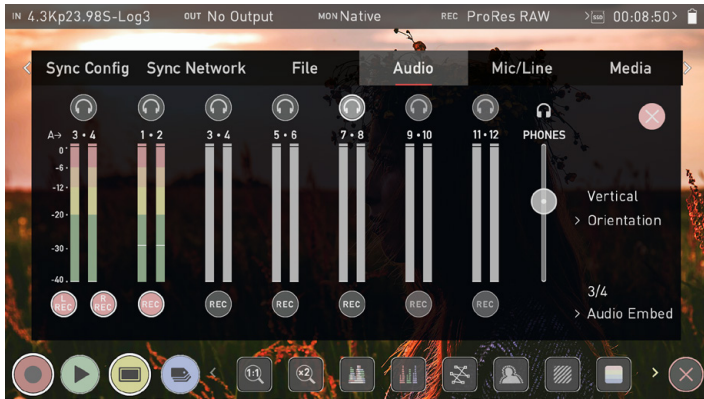

Audio

Audio

The meters and audio settings are easily accessible by touching the audio meters (shown below) on the record, monitor and playback home screens. Touching the meters will take you directly to the Audio menu.



For monitoring the audio there are two types of display available. Access this setting on the Audio page. Options available are:

Horizontal

Displays the 2 channels you are actively monitoring.

Vertical

Displays 8 channels + 2 Analogue Channels.



Monitoring Audio



To monitor the audio, tap the headphone icon next to the channel you wish to monitor from the headphone output. Only one channel (stereo pair) may be monitored at any time using headphones (you can monitor all visually). It is possible to record multiple channels by checking multiple REC buttons.

Audio Embed

Allows you to embed the analog audio channels into the digital signal, so that when you output the video signal over HDMI/SDI this audio is also output as part of the digital signal. Options will depend on how many channels of audio are coming in. When using the SDI module, your Ninja V can record 12 embedded audio channels, instead of the usual 8 channels of audio when using HDMI.

 Selecting the Monitor icon does not mean that track is selected to be recorded. You need to select each channel using the  record button. Tracks that are selected to be recorded have colored Audio Meters. See image above.

 Note that if analogue audio is recorded it will be placed as track 1-2 with embedded audio moving to 3-4. Note if analogue channels are turned on but no audio is present, in many video players you will not hear silence as they often just play the first stereo pair. In an NLE you can easily access all the recorded tracks.



Mic Line

Analogue Audio input

Audio Meters

These meters display the audio levels for the left and right channels of analogue audio. Tap the headphone icon next to the meters to monitor the analogue audio from the headphone output. For more information on meters and monitoring, refer to the Audio section.

Left Gain / Right Gain

Use the +/- buttons to adjust the gain applied to the left and right analogue audio channels.

Audio Delay

This option allows you to delay the analogue audio with respect to the digital audio so that it is in sync with your video source. You are able to adjust audio delays by whole frames.

Audio In

Tap on Audio In to select the input line level that matches your input.

Options available are:

- **Line Level (-10 dBu)**
Sets the analogue input channel to Line Level via the 3.5mm audio jack.
- **Mic Level (-40 dBu)**
Sets the analogue input channel to Mic Level via the 3.5mm audio jack.

Analogue gain can then be tuned by incremental increase or decrease of up to +/- 20dB individually for both left and right channels.

 It is not possible to vary the gain if the signal input is from the HDMI connection because this is digital and is embedded in the signal. You can usually adjust this from the camera, please see your camera manual for operational details.

 Ninja V Mic input supports dynamic and powered microphones only. When using these, audio must be set as Mic Level

Calibrate

Allows you to measure the HDMI video delay from a camera and delay the analogue audio input to sync with the incoming video signal. For more information refer to the AtomX SYNC Expansion Module section.

7. Using the Ninja V



Media

Media

MEDIA INFO

Media menu shows current media type and capacity. Format disks from this menu. See Format Media in the Using the Ninja V - Best Practice section. Information about compatible drives is available at: www.atomos.com/compatible-drives



Date

Date & Time

TIME

- **Time Format**
Tap to cycle between 12H and 24H time formats.
- **Hour/Minute/Second**
Use the plus and minus icons for each setting to set the time used on the Ninja V. This will also change the time of day Timecode.

DATE

- **Month/Day/Year**
Use the plus and minus icons for each setting to set the date on the Ninja V.



Battery

Battery

The Battery icon on the right of the screen indicates the remaining power in the attached battery.

On the left of the screen is a 'power down' button. Hold down for 4 seconds to shut down the unit.

When using the supplied Battery Eliminator, the remaining power indicator will remain green and show 100% full. The displayed voltage will be determined by the input source. Refer to your Ninja V quickstart guide for more information regarding battery life.

When you have an AtomX SYNC module attached to your Ninja V, a small battery icon with the word 'Sync' will be displayed. This battery icon indicates the remaining power of module's internal battery.

 When a battery is running low the battery icon in the upper right corner of the screen will flash and warning menus will appear at 25% and 10%.

7. Using the Ninja V

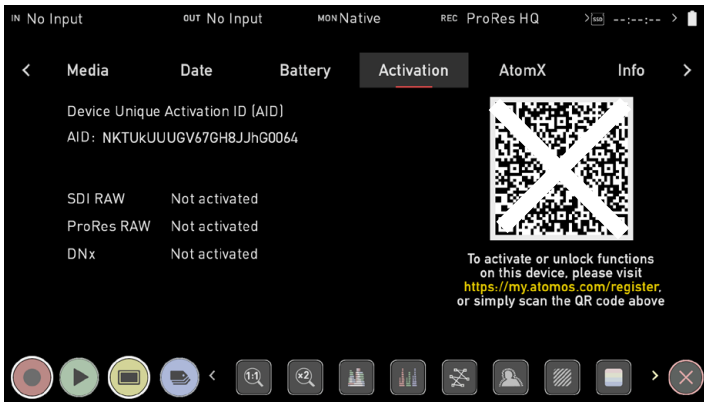

Activation

The Activation page allows you to activate the Apple ProRes RAW, Avid DNx and H.265 codecs, as well as other features like SDI RAW on your Ninja V.

! If you don't see the Activation menu tab, you will need to update your Ninja V to firmware version 10.6 or above.

! If you have previously activated these codecs, you do NOT need to activate these codecs again.

To activate these codecs, use the camera on your smartphone to scan the QR code on the Activation page. Tap on the notification that appears, and you will be taken to **my.atomos.com** in your browser.

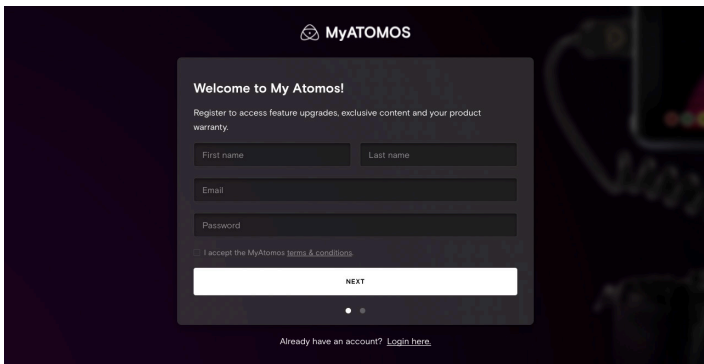

You will be prompted to register as a new user, or login if you are an existing user to your my.atomos.com account. Once you have logged into your account, the 'Product Registration' page will open and the following fields will already be pre-filled:

- Product name
- Activation ID (AID)
- Device ID (DID)

Complete the following fields:

- Serial Number (located in the battery slot)
- Purchase Date
- Reseller

Then tap on Submit to open the 'My Products' page.

Tap on the Ninja V image to open the product page, where you can view the information and upgrade options for your Ninja V. The Features tab displays the codecs and other features that can be activated for your Ninja V, as well as those that are already activated. The Firmware Updates, Warranty and Product manuals tabs provide additional support that is specific to your device. Click to activate your chosen codec/s or features on the Features tab and create an activation token. This can then be downloaded from the my.atomos.com page and will also be emailed to your registered email address.

The token will download as a .zip folder, so you will need to unzip the folder to access the files inside. On a Mac, simply double click on the zip file to unzip it.

Place the activation.bin file on the ROOT of your SSD (Solid State Drive) and insert the disk into your Ninja V. The token file will be detected and automatically open the activation page, allowing you to install the codec/s.

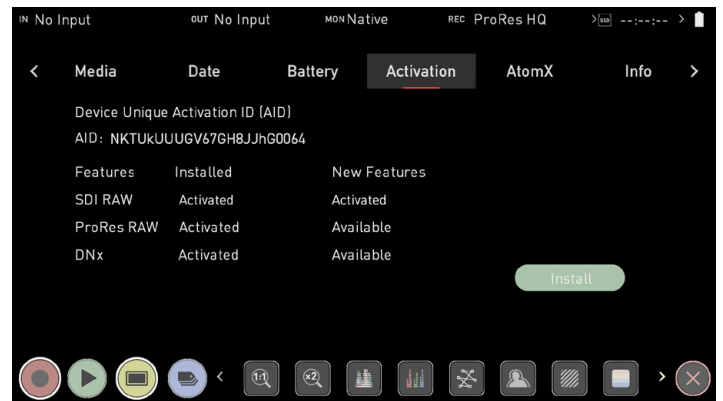

This method allows you to activate both codecs and add other activation keys, which will unlock further features on your device.

! A single activation token will support all functions unlocked on your device via my.atomos.com.

! The activation token will remain in your account on my.atomos.com and also be emailed to your registered address.

Alternatively, you can manually register products and activate codecs at **my.atomos.com**

You will be prompted to register as a new user, or login if you are an existing user to your my.atomos.com account. Then select My Registered Products from the left hand navigation pane and click Register a Product.

Once the Register Your Product screen opens, select Ninja V from the drop-down menu under the Product Name field. Complete the following fields:

- Serial Number (located in the battery slot)
- Device ID (DID) (located in the Info tab)
- Purchase Date
- Reseller

Navigate to the Activation menu page on your Ninja V and use the Activation ID (AID) on that page to complete the Activation field. Tap on Submit to open the 'My Registered Products' page.

Once on the 'My Registered Products' page, follow the steps listed previously in the QR code activation section from the 'My Registered Products' page section onwards, as the process is the same.

7. Using the Ninja V



AtomX

AtomX

The AtomX menu page displays images of attached AtomX Expansion Modules and their versions.

Attaching Modules

To connect an AtomX Expansion Module to your Ninja V, attach it directly to the AtomXansion Port on your device. When a module is mounted, make sure that it clicks into place. To remove an AtomX Expansion Module, press the battery release button on the Ninja V and gently slide the module upwards.

All AtomX Expansion Modules have a battery slot onto which you can connect a compatible NP-F L Series type battery or Atomos Battery Eliminator. The procedure for attaching either of these is the same as when connecting them directly to the Ninja V.

The battery latch on AtomX Expansion Modules will lock the battery into place. To release the battery, slide latch away from the battery and slide the battery upwards.

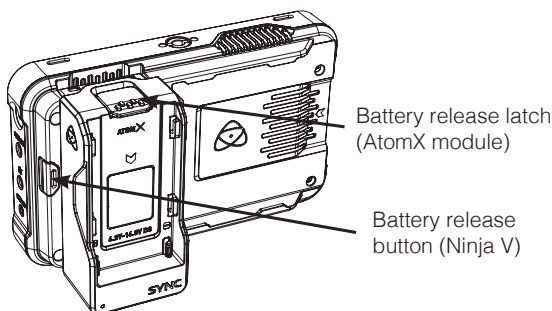

If you have successfully upgraded your firmware and attached an AtomX Expansion Module, you will see a screen similar to the image above. This indicates the fact that your firmware is up to date and that the attached modules are ready for use.

Attaching AtomX CAST to your Ninja V

AtomX CAST attaches to the expansion port on your Ninja V in the following way:

1. Place AtomX CAST on a flat surface with buttons facing upwards, and undo the 1/4-20 screw in the center of the unit to release the top bracket.

2. Line up the AtomXansion port of the Ninja V with the expansion module on the AtomX CAST.
3. Gently slide the AtomX CAST into the AtomXansion port until it clicks into place.
4. Tighten the 1/4-20 screw on the top bracket to secure the Ninja V in place.

To remove the AtomX CAST from your Ninja V, undo the 1/4-20 screw on the top bracket and press the Ninja V's battery release button. Gently slide the AtomX CAST away from the Ninja V.

Stacking Modules

AtomX Expansion Modules also allow for stacking on top of one another. This allows you to take advantage of the features of multiple modules at the same time.

The AtomX menu will display the attached modules and the stacking order. Specifically, the modules will be labelled on screen to indicate which one is the Base Module and which is the Top Module.

To update the firmware of a module, attach the module directly to the Ninja V and then power it up. If a module is at the top of a stack, then it will not update.

When stacking AtomX modules, ensure that the AtomX SDI module is the BASE MODULE and the AtomX SYNC module is the TOP MODULE. It is not physically possible to stack another module on top of the SYNC module.

You cannot have an AtomX SDI Expansion Module stacked on top of another AtomX SDI Expansion Module.

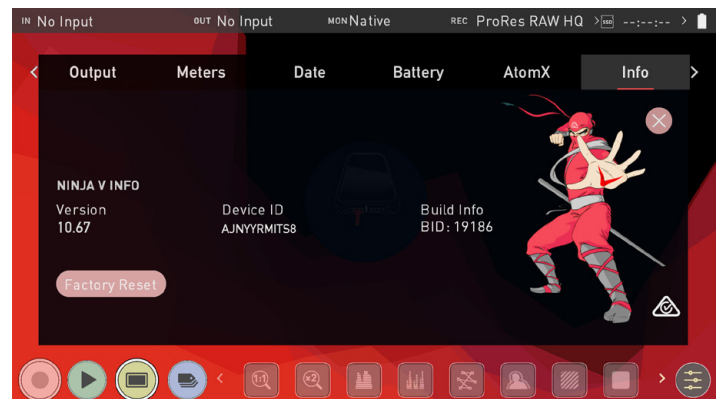

Info

Info

Shows the software (firmware) version and unique device ID (DID) of your Ninja V device. This will be required to activate the Avid DNxHD / Avid DNxHR codec. You can also check on the Atomos website to ensure you are running the latest firmware:

www.atomos.com/support

Factory Reset

Allows you to revert your Ninja V to it's factory condition. All user settings will be lost.

3rd-Party license

Downloads third party licensing documents for software used on your Ninja V to the attached disk.

8. Using the AtomX CAST

AtomX CAST

The AtomX CAST is a modular expansion for the Ninja V, that connects to the AtomXpansion port to convert the Ninja V into a fully functional stand-alone video switcher with 4 x 1080p HDMI inputs, a multiview monitor and broadcast quality recorder, with graphic overlays, picture in picture functionality and a streaming output.

When using AtomX CAST, the Information Bar at the top of the Ninja V screen displays information and settings for your project rate, outputs, audio settings and more. Touching any of these areas will take you to the relevant menu. To use AtomX CAST with your Ninja V, firmware version 10.71 or later needs to be installed.

Main Screen

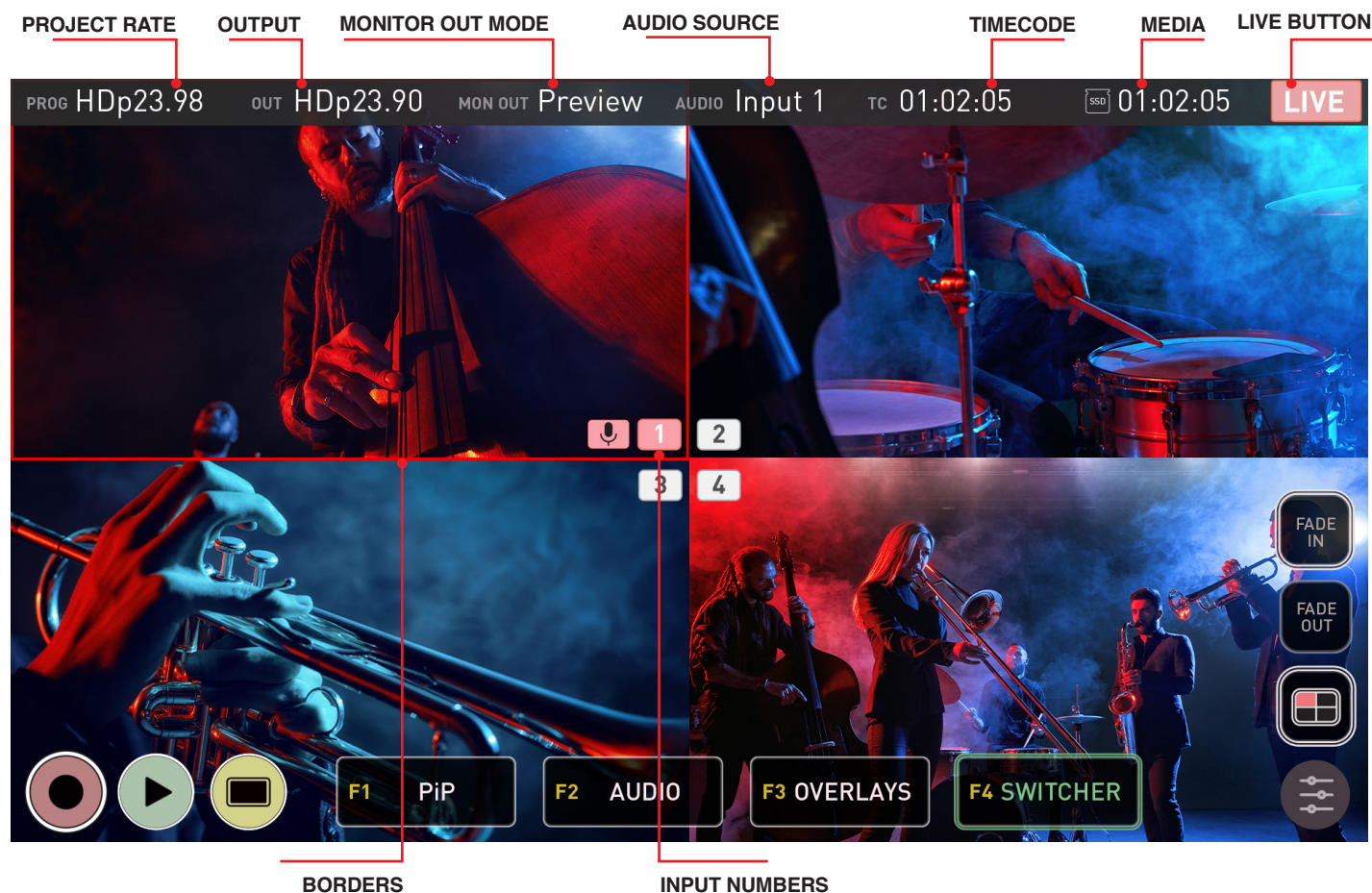

PROJ: Displays the Project Rate, which is determined by the resolution and frame rate of the Primary Input.

OUT: Displays the active video resolution and frame rate being output from the CAST Out and the CAST USB-C connectors on AtomX CAST.

MON OUT: The output mode of the Ninja V HDMI Out connector. This can be selected in the Output and Switcher menu pages, and can be set to: Program, Preview or Multiview.

AUDIO: Displays the audio source that you selected in the Audio menu page. When HDMI Input is selected, the chosen input will be displayed, eg. Input 1. Where Mic/Line has been selected, MIC/LIN will be displayed and AFV will be displayed where Audio Follows Video has been selected.

TC: Displays Timecode.

MEDIA: Displays the remaining recording time on your media, based on the chosen codec and remaining capacity of the drive.

LIVE: The Live button allows you to enable or disable the live stream output. It is important to note that the LIVE button must be pressed to allow your program feed to be output to your streaming software and/or connected Program display via the CAST USB-C and CAST HDMI outputs.

A connected display in Program mode can be used to confirm that you are outputting a stream to your audience, as well as what they are seeing. This output will not have an image until you are live. Tapping the button will cycle between red for enabled, and greyed out when disabled.

 *If a Primary Input has not been selected, the Live button cannot be enabled.*

BORDERS: The borders around the inputs indicate the status of each input. When selected as the program output, the border around that input will be red. A green border indicates that the input is being previewed in Two Touch switching mode.

INPUT NUMBERS: The input numbers in the center of the screen indicate the status of each input. They will be white when there is a valid input, and greyed out when there is no input. When selected as the program output, the input number will be red. The input number will be green when the input is being previewed in Two Touch switching mode.

8. Using the AtomX CAST - Main Screen

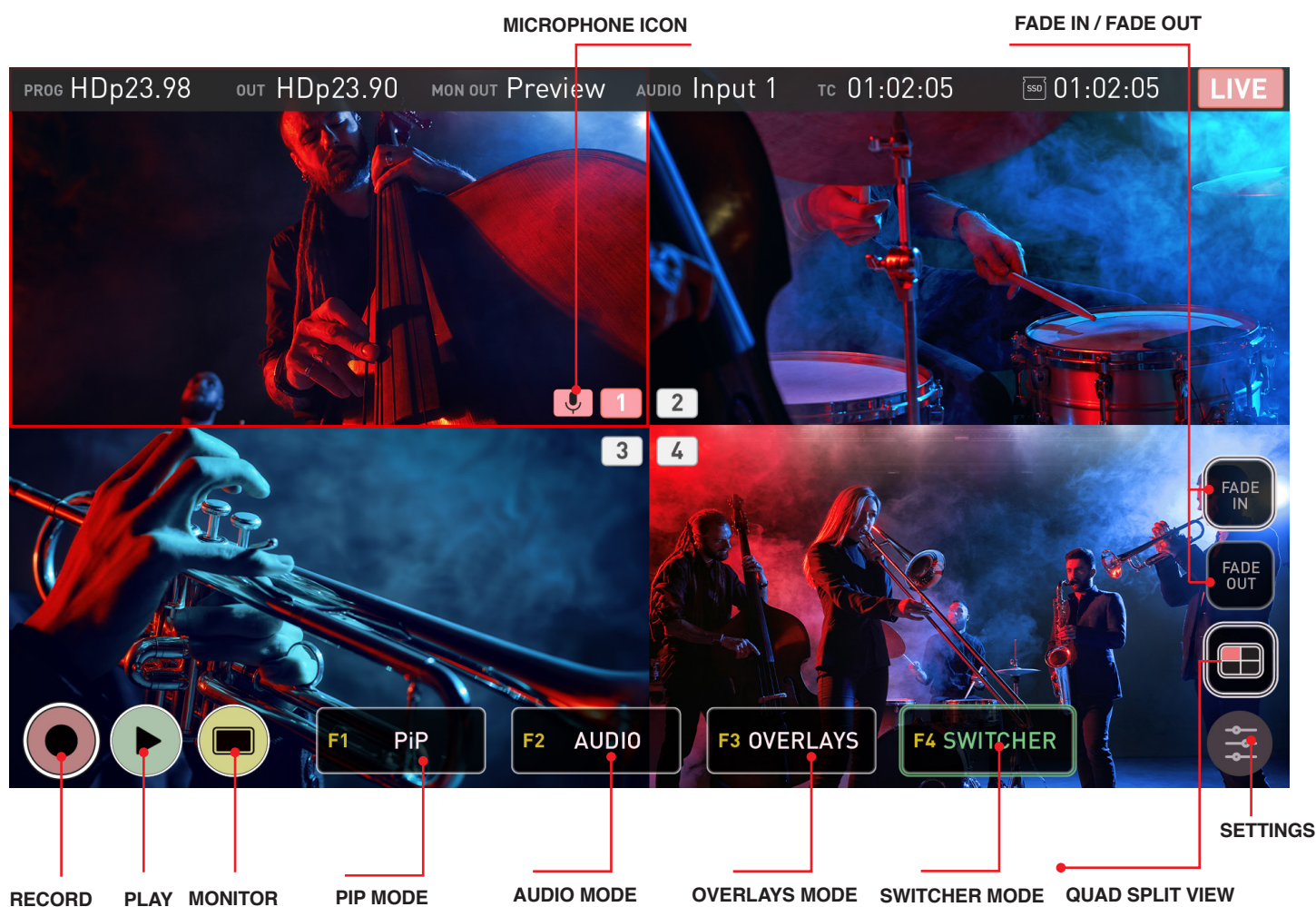

MICROPHONE ICON: Where the audio source is set to HDMI Input, a red microphone icon will appear next to the input number in the center of the screen to indicate that the input is the current audio source. If there is no audio coming from the input, a grey microphone will be displayed instead. In Audio Follows Video (AFV) mode, a blue microphone icon will be displayed next to the input that is the current audio source.

Where Mic/Line has been selected as the Audio Source, MIC/LIN will appear at Audio at the top of the screen to indicate the mode. No microphone icon is displayed over any of the inputs.

FADE IN / FADE OUT: These buttons can be used to fade in or fade out of your program. You can set the color to fade to/from as White or Black in the Switcher menu. Having dedicated Fade In/Out buttons gives you complete control so that you can fade out from one input, switch to another input and fade back in. Fading In/Out also applies an Audio fade effect.

Fading In/Out of the program stream is visible on the live stream over USB-C and on displays connected to the HDMI Output on the AtomX CAST. It is not recorded to the HDD/SSD.

QUAD SPLIT VIEW BUTTON: Tap to toggle between the multiview mode where you can see all four inputs at once for switching, and the single input view which displays one input at a time. The single input view is perfect for checking and adjusting each input fullscreen, with the aid of the monitoring tools. Tap the button again to return to the quad split view for switching.

SETTINGS: Pressing the settings button will take you to the corresponding menu page for the current mode: PiP, Audio, Overlays and Switcher.

RECORD: Press to begin recording the program stream.

Program graphics, PiP and Fade In/Out cannot be recorded onto the SSD/HDD in the Ninja V. To record these graphical elements, connect an external recorder to PGM Out of the AtomX CAST

The LIVE button must be pressed to allow your program feed to be output to your streaming software and/or connected Program display via the CAST USB-C and CAST HDMI outputs. The LIVE button must be enabled for either of these outputs to be active.

PLAY: Press to enter playback mode and play back the most recently recorded clip. Tap RECORD to return to the switching/recording mode.

When you are live, the Playback button will be greyed out and disabled. This ensures that the stream cannot accidentally be played back during a live session.

MONITOR: Tapping Monitor in single input view mode reveals the monitoring tools, so that you can switch between the camera inputs and use the tools to check your shots. You can use scopes like the Waveform to check exposure, Focus Peaking to check focus and Frame Guides to help you frame your content for a specific aspect ratio or for social media. For more information, refer to the Monitoring & Recording section.

8. Using the AtomX CAST - Main Screen

Function ICONS F1- F4: These icons have the same effect as the physical F1-F4 function buttons on AtomX CAST. Tapping the F1-F4 icons or pressing the physical F1-F4 buttons will allow you to use the four physical 1,2,3,4 pad buttons on the unit to switch between options in the selected mode. The following refers to the icons on screen, as well as the physical buttons on the unit.

- **F1 PiP (Picture in Picture)**

In this mode, the 1-4 buttons act as a PiP switcher. Once F1 has been selected, you can use the pad buttons to select an input to use as a PiP over the Program Out. The currently selected input button on AtomX CAST will be red to indicate it is live. Pressing one of the other input buttons will turn them yellow, and select that source to be displayed as a picture in picture over the current program output. Press one of the other pad buttons to use that input as a picture in picture instead. Pressing the input button whilst it is yellow or pressing the red input button, will turn off the PiP effect on the program out.

When in F1 PiP mode, pressing the settings button will open the PiP menu page. For more settings in relation to the PiP function, refer to the Picture in Picture menu page section.

 You can change the size, position and opacity of the PiP whilst it is live, by using the PiP menu page.

- **F2 AUDIO**

In this mode, the 1-4 pad buttons act as an audio switcher. Once F2 has been selected, you can then use the input selection pads 1-4 to switch between the audio from the 4 x HDMI inputs connected to AtomX CAST. The selected input button will turn red when pressed. Pressing the pad button whilst it is red, will switch to AFV (Audio Follows Video) mode, and the button will turn blue. Pressing on the selected input button when blue will switch to the audio from the selected input again.

When in F2 Audio mode, pressing the settings button will open the Audio menu page. For more settings in relation to Audio sources, refer to the Audio menu page section.

- **F3 OVERLAYS**

In this mode, the 1-4 pad buttons act as a graphics switcher. Once F3 has been selected, pressing one of the input selection pads 1-4 will turn the selected pad button green and apply the overlay to the Preview output of the Ninja HDMI output. This allows you to preview each of the graphical presets over the current input. When you decide on the preset to use, press and hold the green input button to turn the button red and lock that graphical preset to the input.

The preset will appear on the Program feed and be locked to this input so that whenever you switch to that input in switcher mode, the graphics in the selected preset will appear. This is especially useful where you have multiple speakers, as they can all have a lower thirds graphic with their name and details appear whenever you cut to them. You can deactivate an overlay in both program and preview modes, by holding the the button until the red light changes to white.

When in F3 Overlays mode, pressing the settings button will open the Overlays menu page. To create or adjust the graphical overlay presets and for more settings, refer to the Overlays menu page section.

 If the F2 function is used as described above when Mic/Line is selected in the audio menu page, the Audio Source will switch to HDMI Input mode.

 If you have selected analog audio input, none of the pads will be illuminated red.

- **F4 SWITCHER**

In this mode, the 1-4 pad buttons preview and switch between the inputs. When F4 is initially selected, it will turn red and One Touch switching mode will be enabled. Tapping/pressing the F4 key again whilst it is red, will cause the F4 button to become green and the Two Touch switching mode will be enabled. In this mode, you can preview inputs before actually switching to them.

Tapping on another input via the 1-4 pad buttons or on the multiview screen in this mode, will place a green preview border around the chosen input on screen, and the corresponding input selection button on the AtomX CAST will also be green. The selected input will also be displayed on a connected display in Preview mode. If you select another input instead, the selected input will be previewed instead. This allows you to literally preview your inputs before you cut to them in the program feed.

A second tap on the same input on the display or on the input selection button whilst they are green, will turn it red and cut to that input immediately. If you do not want to switch to the input being previewed, tap on the currently selected input again on the Ninja V display or press the input selection button that is red. Selecting the F4 key whilst green will return to One Touch switching mode.

When in F4 Switcher mode, pressing the settings button will open the Switcher menu page. For more information on switching settings, refer to the Switcher menu page section.

8. Using the AtomX CAST



Input

Source Input

The Input menu provides information and settings for the 4 x HDMI inputs on AtomX Cast.

HDMI ICONS 1 > IN 2 > IN 3 > IN 4 > IN

The HDMI icons for each input will be white where a valid input is detected. The icons will be faded with an 'x' when no input is connected. The physical 1,2,3,4 buttons on the AtomX Cast will also have a white light when a valid input is detected and will not be illuminated when there is no input.

 *If an input is not detected, unplug and reconnect the HDMI cable for the input to AtomX CAST.*

Name

Provides information on the names of each input.

Primary Input

A green circle with a 'P' will be visible below the source that is the current Primary Input. The Primary Input will determine the project rate and provide sync for other inputs. By default, the first connected source will be used as the Primary Input. To select another source, tap on the white circle in the Primary Input row, below another input. Other inputs with a different frame rate up to 1080p60 will be conformed in the background to match the project rate.

 *Ensure that you have selected the project rate before going live, as this cannot be changed when live. If you do change the project rate whilst being LIVE you may lose your USB-C connection, and have to unplug it and reboot the device.*

Video Mode

Displays the resolution and frame rate for each input. No Input will be displayed where a valid input is not detected.

Project Rate

The frame rate of the Primary Input will be used as the Project Rate by default, and all other inputs up to 1080p60 will be conformed to this frame rate.

Graphics

Indicates the graphical overlay presets that are applied to each input.

Audio Pairs

Indicates how many audio pairs are associated with each input. No Input will be displayed where a valid input is not detected.

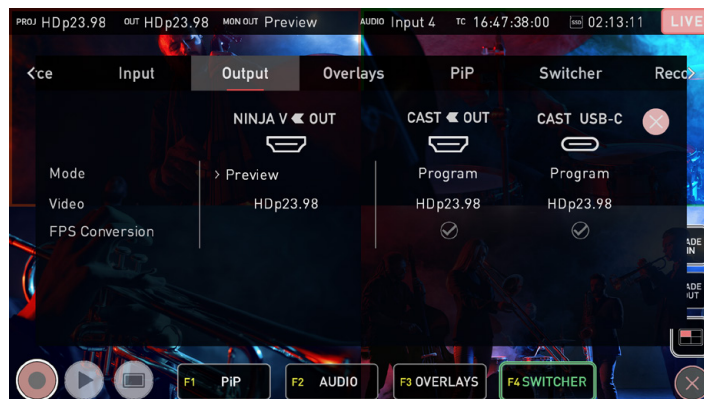

Output

Output

The Output menu allows you to customize your setup, by choosing what to display on the outputs.

Mode

Displays the mode that each of the outputs is currently set to. The icons will be faded with an 'x' when not connected.

NINJA V OUT

Allows you to select the mode for the Ninja V's HDMI Out connector, for displaying on a secondary output. The frame rate will be the same as the project rate. Tap on the currently selected mode to cycle through the following options:

- **Program:** Displays the 'program' that you are streaming to your audience. This mode shows you exactly what they will see.
- **Preview:** Allows you to preview inputs before you cut to them in the program feed, as well as preview graphics.
- **Multiview:** This mode allows you to see all four inputs at once, without Graphic overlays, PiP, Program/Preview and audio channel status

CAST OUT / CAST USB-C

Displays the current mode for the HDMI Program Out and USB-C connectors on AtomX CAST. These outputs are linked and will always display the program feed.

FPS Conversion

Displays conversions of resolution and frame rate. A green circle with a tick will indicate successful FPS conversion to the project rate. A circle with an 'X' will be displayed in the CAST OUT and CAST USB-C columns when FPS conversion is not activated.

8. Using the AtomX CAST

CAST USB-C streaming output is limited to a maximum of 1920x1080p30. Projects that have a frame rate of 50p or 60p, FPS conversion will be applied, and both the HDMI and USB-C outputs from the AtomX CAST will output at a half frame rate i.e p50 as p25 and p60 as p30.

HDMI projects can be output as 1920x1080p50 or p60 without FPS conversion but the CAST USB-C streaming output will not be available.

 FPS conversion can only be activated when you are not live.

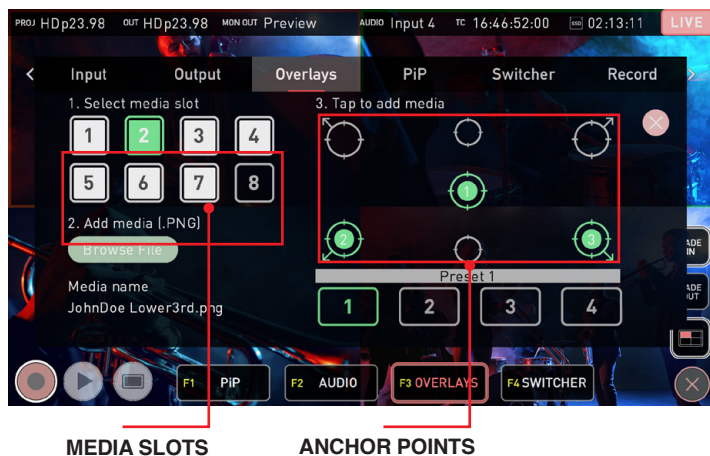

Overlays

Graphical Overlays

The settings in this menu allow you to upload up to 8 custom graphics to the Ninja V's internal memory, and then assign them to the anchor positions within the four layout presets. The presets can then be set to appear on certain inputs whilst switching.

Image creation programs like Adobe Photoshop can be used to create your own custom graphics for a logo, masthead, lower thirds graphic or even a large image that covers the entire screen.

Graphics must be in the PNG format, but can be any resolution up to 1920 x 1080. Graphics that contain alpha channels/ transparency are also supported.

 If using an image creation program like Adobe Photoshop to create graphics, ensure that you save them in .PNG format.

 Graphics can be up to 1MB in file size.

Graphical overlays do not appear on the multiview screen of the Ninja V, but can be previewed on a connected display in Preview mode before being used in the Program. You can also set and lock a graphical preset to an input so that it appears each time that you switch to that input. For more information refer to the Using the AtomX CAST section.

Presets 1-4

Select one of the four presets along the bottom marked 1-4 to select a preset to create/edit. When this preset is selected during switching, the graphics will appear on screen in the position(s) you have selected.

Media Slots 1-8

Each of these numbered media slots can store a .PNG graphic in the Ninja V's internal memory. Tap on one of the numbered media slots to select one of the slots. If all slots are full and you want to add a new graphic, select one of the slots and tap Browse File. You will be prompted to overwrite the graphic that is currently saved in this slot.

Browse File

Tap on Browse File to browse the SSD/HDD inserted in your Ninja V for PNG media. Tap on a .PNG file to select it and tap on it again to load it into the selected media slot. The filename of the selected media will be displayed below Browse File.

 You can use a graphic in multiple presets, but you can only have one instance of each graphic in each of the presets.

Anchor Points

Each of these circular positions is an anchor point, which anchors the graphic to the chosen position. If you select the top left anchor point, the top left corner of the graphic will be anchored to the top left corner of the frame. If you select the bottom left anchor point, the bottom left corner of the graphic will be anchored to the bottom left corner of the frame. For the three center anchor points, the centre of the image will be anchored to the chosen anchor point.

After selecting one of the media slots, tap on an anchor point to add the graphic to the chosen anchor point location on screen. A green circle with the media slot number will appear in this position.

To relocate the graphic, tap the location anchor and the green icon will disappear, removing the graphic from the location. Tap on another anchor point to relocate the graphic to that anchor point instead.

 In order to clear graphics from assigned positions, tap on each graphic in each preset to disable them individually.

 Program graphics are not recorded onto the SSD/HDD in the Ninja during recording. This allows you to record a clean feed of the program without overlays for revisioning during the editing process. To record graphical elements, connect an external recorder to PGM Out of the AtomX CAST.

 If your graphic is not in the correct file format or within the 1MB size limit, an error message will advise that the image is not in the correct format.

8. Using the AtomX CAST



PiP

Picture in Picture (PiP)

This menu allows you to display an input as a scaled input overlay in the corner of the screen over the top of any program output, so that they both appear on screen at the same time. You can use this feature to present to the camera, whilst showing the viewer another angle, a presentation or pre-recorded content at the same time. In order to see the PiP appear over another input, a connected display in Program mode is required.

Picture in Picture On/Off

Enable/Disable the Picture in Picture function by tapping the On/Off switch.

Opacity

Use the slider to adjust the opacity of the PiP input.

PIP Size

Allows you to select the size of the PiP effect by tapping on one of the two preset sizes: small or large.

Set PiP Position

Adjust the position on screen for the picture in picture effect to be displayed.

PiP Input

Select the input that will appear as a PiP over the input that is live.

 The system automatically disables PiP when it is not required, such as in situations where you would have a PiP image displayed over the same image.

 The PiP is not recorded onto the SSD/HDD inserted in the Ninja V during record mode. To record the PiP, connect an external recorder to PGM Out of the AtomX CAST

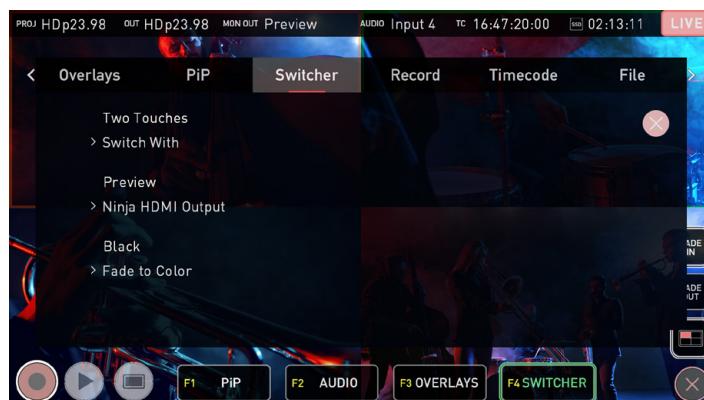

Switcher

Switcher

This menu allows you to customize your settings for switching.

Switch With

Allows you to select the style of switching to use whilst in the Switcher mode. Tapping Switch With or the F4 button, cycles between the options:

- **One Touch**

In this mode, a single touch on one of the inputs on the Ninja display when in multiview mode, or on one of the physical 1-4 buttons on the AtomX CAST, will switch to the corresponding input immediately. The input on screen will have a red border around it and the corresponding button on the CAST will turn red when selected, to indicate that it is live. The F4 button will also be red in One Touch mode.

- **Two Touch**

Two touch recording, follows the traditional broadcast preview and program switching style, which allows you to preview an input before actually switching to it. Whilst in this mode, the program feed on the Ninja V display will have a red border and the corresponding input selection button on the AtomX CAST will also be red.

Tapping on another input will place a green preview border around the chosen input on the display, and the corresponding input selection button on the AtomX CAST will also be green. This indicates that the input is being previewed as the next source to cut to. The selected input will also be displayed on a connected display that is in preview mode.

A second tap on the same input on the display or on the input selection button whilst they are green, will cut to that input immediately. If you select another input instead, that will cause that input to be previewed instead. If you do not wish to switch to the input being previewed, tap on the program feed again on the Ninja V display or press the input selection button that is red.

8. Using the AtomX CAST

Ninja HDMI Output

This setting allows you to select the mode for the HDMI Output connector on your Ninja V. This will determine what is displayed on a monitor connected to this output.

Tap the setting to cycle through the options:

- Program
- Preview
- Multiview.

Background Color

Sets the background color that your image will fade to when using the Fade In or Fade Out buttons. Tap the setting to cycle through the options: White and Black.

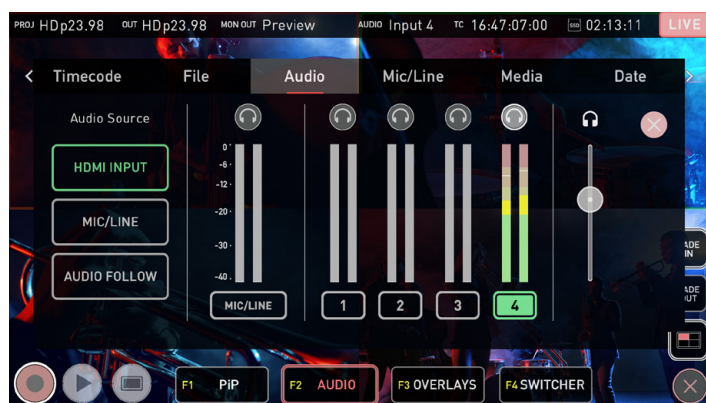

Audio

Audio

This menu allows you to select the audio sources that will be used for the program output.

Audio Source

Tap the buttons to select the audio source:

- **HDMI Input:**
Allows you to select the audio from one of the inputs connected via HDMI as your audio source. If you have four cameras connected to AtomX CAST, it would allow to use the audio from one of the cameras, which could be scratch audio from the camera's internal microphones, or audio from a microphone connected to the camera. For other types of inputs like pre-recorded videos, the audio could be coming directly from the source. After selecting HDMI Input, tap on the input number to switch to the audio from that input. A red microphone appears in the corner of the input displayed on the Ninja V when in multiview mode, to indicate the source of the audio.

- **Mic/Line:** This option allows you to connect an external audio source to the analog 3.5mm Mic/Line jack on your Ninja V. In Mic mode, a dedicated high quality microphone can be connected directly or via an audio mixer which can dramatically improve your audio quality. You could also use this input in Line mode, to add music to your production from an external source. The Mic/Line menu page allows you to adjust the settings for Mic/Line inputs.

- **Audio Follow (Audio Follows Video):**

When Audio Follow is selected in the Audio menu page, the audio will follow the video switching, so the audio from the currently selected input will be used. The corresponding physical pad button will also turn blue in this mode.

Headphone icons

The program audio can be monitored by connecting headphones to the 3.5mm headphone/audio out jack on your Ninja V. Whilst in CAST mode, only the program out can be monitored. If you switch between audio sources or AFV, the headphone monitoring will automatically switch to allow constant monitoring of the program audio. Levels for other inputs can only be monitored on the meters visually.

Audio Meters

Displays audio levels from the embedded audio of the four HDMI inputs/cameras.

Headphone Volume Slider

This slider allows you to adjust the monitoring volume of the selected audio input.

- 🚩 *The headphone slider volume has no impact on the actual audio levels for each connected source, so if it is too loud you will need to adjust the audio levels on the connected camera or source.*
- 🚩 *You can select either the audio pair coming from the analog in (Mic/Line connection), OR the audio pair from the selected camera. There is no support multi channel audio.*
- 🚩 *To ensure that analog audio is synced correctly with the audio from your HDMI sources, connect analog audio sources to one of the HDMI cameras/sources and select the audio from this input as your audio source. This will ensure that the audio will always be in sync with the video.*

9. Monitoring & Recording

Setting up for recording

As soon as you connect a supported signal to the Ninja V input and have inserted a formatted drive the following will happen;

- The **REC** icon will be illuminated (red)
- The input source & format will be shown in the top left corner of the information bar
- Audio input meters will be responding to source.

Ready to Record (monitor mode/home)



Ready to Record (monitor mode/features)



No Input / No Disk / No Disk Formatted

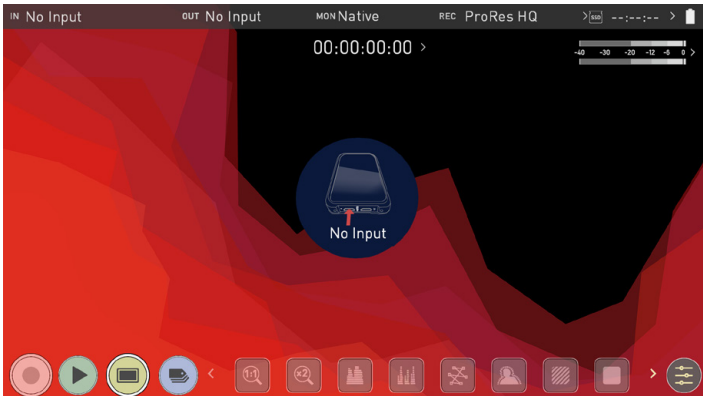

SmartControl

SmartControl is a versatile set of functions used to control the starting and stopping of recording by automatic or external means. This section outlines the different methods to start and stop recording.

Ninja V Start and Stop record control can be triggered by the following methods:

1. Home Page Touch Screen
2. HDMI Rolling Timecode trigger
3. HDMI Camera trigger
4. Via LANC for Sony and Canon Cameras
5. Via LANC serial port

 Some cameras perform optimally when triggering from the camera and not the recorder.

1. Home page Touch Screen

By pressing REC (Record) and STOP to end recording



2. HDMI Rolling Timecode Trigger Record

If the camera is in Record Run mode, recording can be stopped or started by a moving Timecode via HDMI.

When enabled the camera and the Ninja V will start and stop recording simultaneously.

 Rolling Timecode trigger is for use in older cameras with TC only and no trigger. If your camera is set to FREE RUN this trigger will start recording immediately. Please be aware that not all cameras have Start/Stop flags for triggering record, especially older cameras. In such cases rolling trigger in REC RUN will need to be used to trigger recording automatically at the same time as the camera starts recording.

3. HDMI Camera Trigger Record

The HDMI Camera trigger is available for supported cameras.



There is a flag within the digital signal that lets the Ninja V know the start/stop record has been pressed on the camera; in turn this will trigger the Ninja V to start/stop recording at the same time as the camera.

9. Monitoring & Recording

Monitoring Features

At the bottom of the Monitoring screen are the Monitoring Features, accessible by toggling the MON icon. Monitoring Features do not affect your recorded file and can be turned on and off, or adjusted whilst recording. Not all Monitoring features are available at first glance.



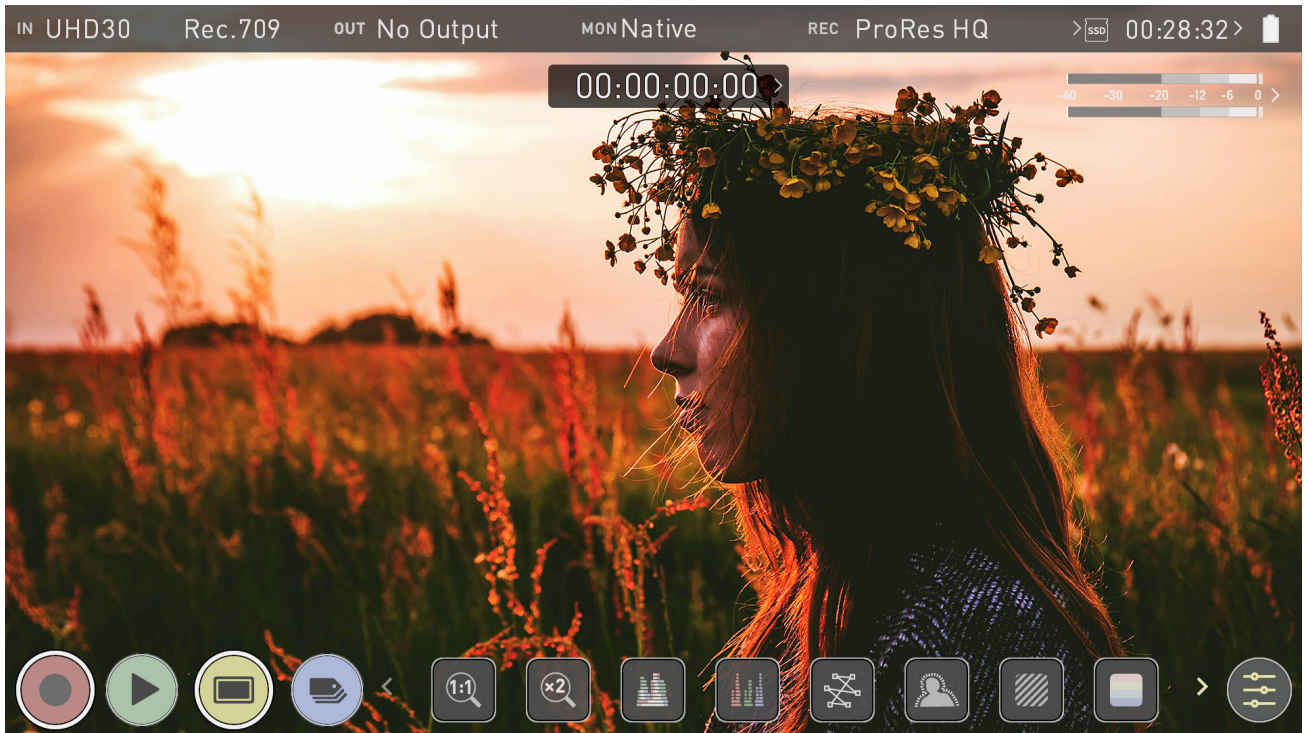

To reveal all Monitoring features, swipe monitoring feature icons to the left. The icons will behave in a carousel like manner and you can swipe left and right to access any of the features. At the bottom right is the settings button. Press Settings to adjust behaviours of Monitoring Tools.





Monitor Mode / Features



Monitoring Features Activation Icons

AtomOS 10 features a new and improved layout of Monitoring tools. These can be toggled on and off simply by touching the large yellow MON icon. When Monitoring tools are displayed, swipe left to reveal more icons. Tapping on the icons will enable the features. Many of the tools can be used simultaneously to assist with focus, exposure, framing and more. Here is a quick guide to what each icon represents.

- **Luma Waveform**
A great way to visualize the dynamic range of your image.
- **RGB Parade**
Monitor the level of red, green and blue from an input source.
- **Vectorscope**
This is useful for checking if an image is under or over saturated.
- **Focus Peaking**
Ensure your recordings are always in focus.

- **Zebra Pattern**
Use Zebra to check exposure and set exposure levels.
- **False Color**
A visualization of exposure across the image.
- **Blue Only Exposure**
Observe the noise content of a video image.
- **Zoom 1:1**
Punch in and check critical focus.
- **Zoom 2:1**
Toggle 2:1 to magnify the screen.

9. Monitoring & Recording

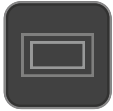

Frame Guides

Cine, TV and Social frame guides

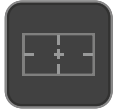

Safe Areas

Action area and title safe areas displayed.



Anamorphic Desqueeze

Allows you to see a correctly squeezed image when using anamorphic lenses



Settings

Press to access settings for monitoring tools

 The Monitor Features will only be illuminated and available if there is an input signal detected.

Using Waveform Monitoring tools (WFM)

Luma Waveform

The Luma or Luminance Waveform is a great way to visualize the dynamic range of your image, allowing you to protect exposure of both your highlights and shadow detail. It's particularly useful when shooting with a low contrast LOG curve and works in perfect partnership with HDR to illustrate and highlight the clipping point to allow you to correctly expose your image.

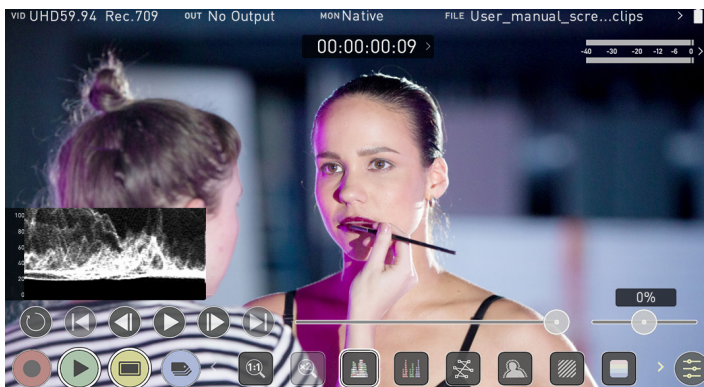

RGB Waveform

RGB Waveform will monitor the level of Red, Green and Blue from an input source. The RGB channels are displayed side by side and each channel color is shown under the corresponding waveform. This can be used to check the white balance. Just point the camera at something white and the Red, Green and Blue levels should match if white balance is setup correctly on the camera.

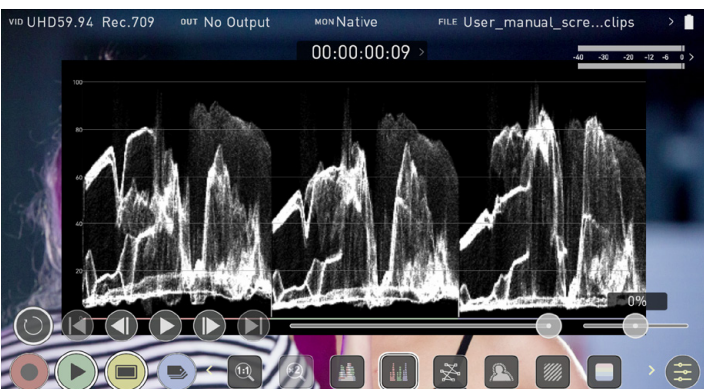

The Waveform Monitor will remain on screen when hiding the overlays ensuring the focus remains on calibrating your image. If the MON button is pressed the WFM will move in to the bottom icon line up.

Vectorscope

The Vectorscope display shows color information of hue (shown as a phase vector), and saturation (measured by outward distance from the center). This is useful for checking if an image is under or over saturated and for calibrating multiple cameras to ensure greater consistency between shots.

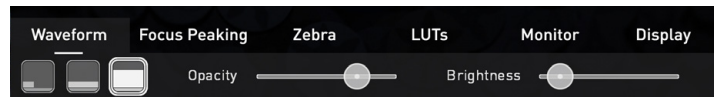
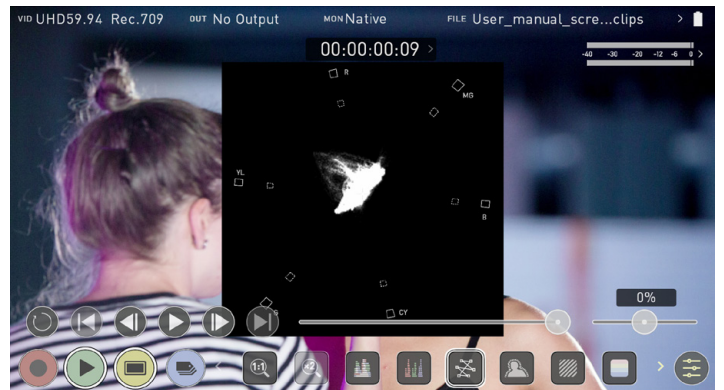

Waveform Monitor Settings

To access Waveform Monitoring settings simply touch on the Settings icon and select the **Waveform Tab**.



To change the size of the waveform, press on the 1/4, 1/3 or Full Screen icons and the display will update immediately.



Waveform Size settings



To toggle between Waveform Monitor sizes of 1/4, 1/3 and Full Screen during monitoring, recording and playback, tap in the bottom left corner of the screen. You can also adjust the brightness and opacity of the waveform display whilst recording, monitoring or during playback.

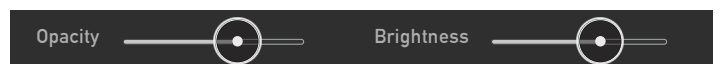

The Brightness slider directly controls the intensity of the waveform while the opacity slider adjusts the transparency values of the waveform display on screen. Experiment with these controls to achieve your desired monitoring setup.

9. Monitoring & Recording

Using Monitor Assist tools

AtomOS10 features monitoring tools that help with making your shot picture perfect. Easily access Focus Peaking, Zebra, False Color and Blue Only Exposure to check image is in focus, noise free and correctly exposed. Options for safe area/ title area markers along with aspect ratio markers and anamorphic de-squeeze functions are also available.

Focus Peaking

Focus peaking allows the user to ensure their recordings are always in focus. The parts of the image in focus are highlighted by the selected color (can be adjusted by dragging the slider). There are a number of options for how peaking is displayed, it can be overlaid the color video image, a greyscale image or just show the peaking by selecting the corresponding icon.

Focus Peaking Color

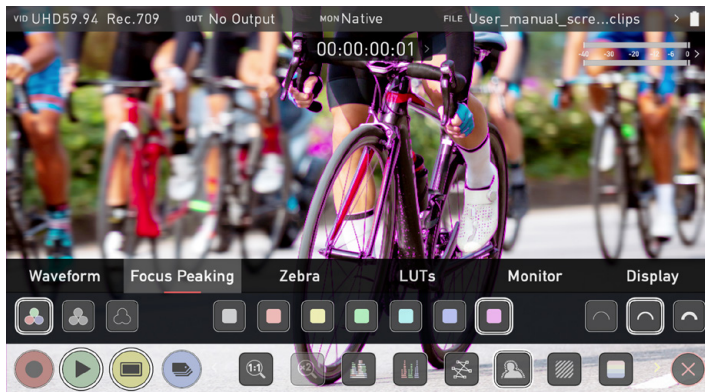

Focus Peaking Mono

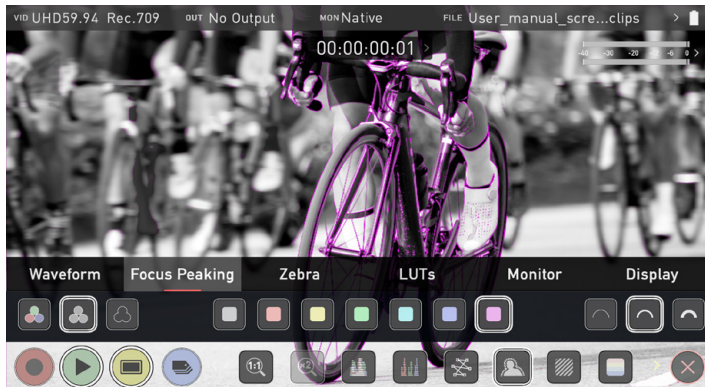

Focus Assist Outline

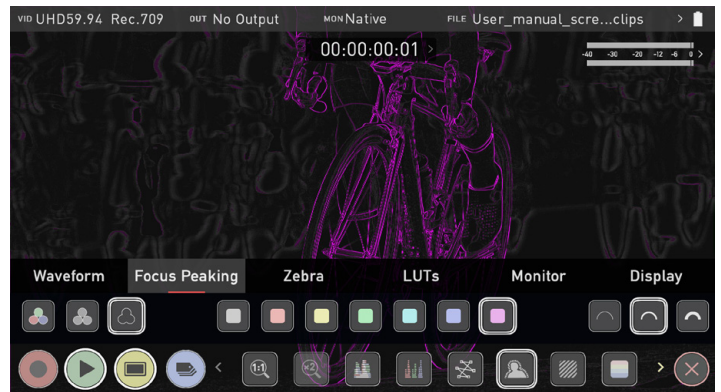

You can change the focus peaking colors and modes by touching the icons in the focus peaking menu.



Zebra Threshold

Zebra pattern show the parts of the image that are exposed +5% of the target level set. The Zebra threshold value can be adjusted by moving the slider left or right.

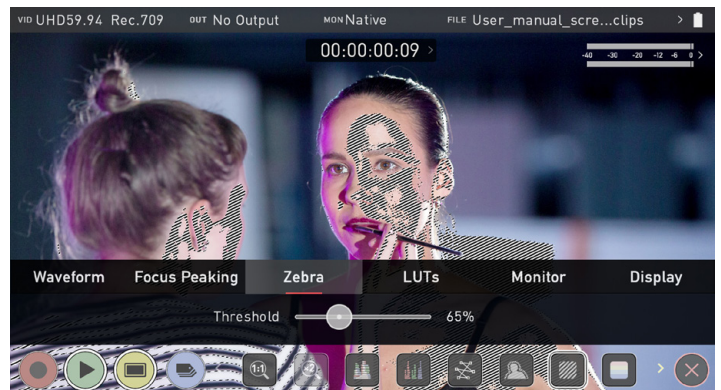

False Color

False colors allow you to quickly expose your image by seeing an overall representation of brightness grouped into meaningful colors. A legend that correlates brightness values with specific colors is present on the left-hand side. The numbers in this scale represent the IRE %.

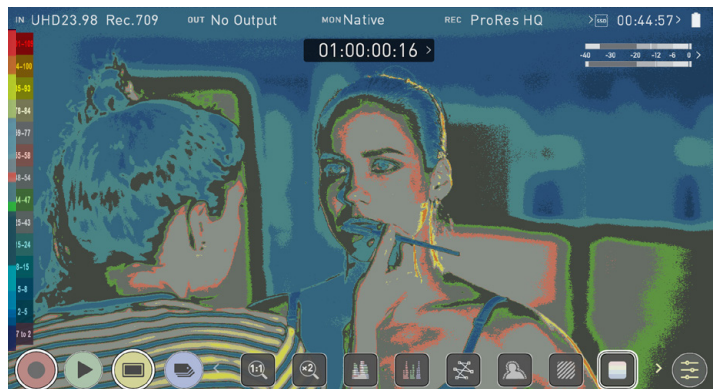

9. Monitoring & Recording

False Color Scale

As an example, mid grey is present between 44-47 IRE (green), underexposed footage is -7 to 2 IRE (purple), and overexposed footage is from 96-109 IRE (bright orange).

Blue Only Exposure

Blue only displays a greyscale image based on the blue channel of the input signal. This is useful to observe the noise content of a video image as sensor noise is most visible in this channel.

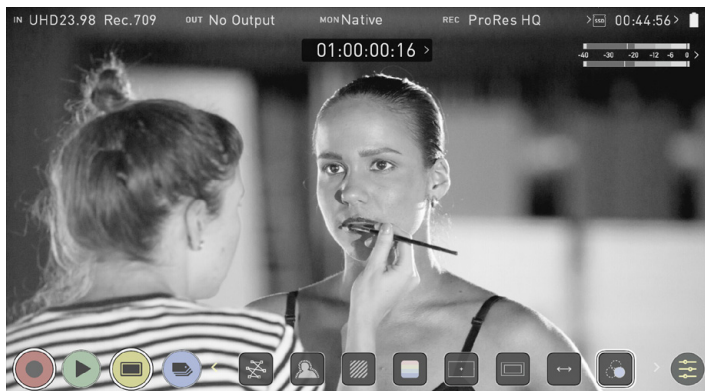

Zoom

Zoom mode enables you to punch in and check critical focus



Toggle 1:1 to display 1:1 pixel mapping, the indicator box shows the location of the screen you are viewing.

- 4K 1:1 shows 1/4 of the 4K UHD image.



Toggle 2:1 to magnify the screen, the indicator box shows the location of the screen you are viewing, you can move the zoomed location by dragging across the screen or selecting a portion of the indicator box.

- 4K 2:1 shows 1/16 of the 4K UHD image.

Cinema Guides / Safe Areas / Anamorphic De-Squeeze

AtomOS 10 has advanced frame guides and safe areas. You can cycle through your required cine or TV frame guides by repeatedly pressing the guides icon. Action safe area and title safe areas can then be turned on and are proportional to the frame guides based on SMPTE standards.



To enable guides press the Cinema guides icon to cycle through your chosen aspect ratio. The aspect ratio markers are very useful with the 2x Anamorphic De-Squeeze to preview crops that could be made in post. To turn on the safe area markers tap the Safe area icon once for the Action area and again for the title safe area.

Frame Guides

 The Safe Area/Grid Lines will still be visible when tapping the center of the screen to hide the overlays.



Frame Guides



Safe Areas



Anamorphic De-Squeeze



 The Safe Area/Grid Lines will still be visible when tapping the center of the screen to hide the overlays.

Safe Guides



De-squeeze



Allows you to de-squeeze images when monitoring content filmed with anamorphic lenses.

Tap the de-squeeze icon to cycle through the options to select the amount of de-squeeze required, so that the image on your Ninja V is not distorted. The options are: 2x (4:3), 2x, 1.8x, 1.5, 1.33x, 1.25x

 Scopes are not available when de-squeeze is activated.

9. Monitoring & Recording

LUTs

A LUT or **Look Up Table** is a table that transforms the color response and as such adjusts the 'Look' of the input. 3D LUTs have a combination of three inputs defining the combination of R, G, and B values allowing for adjustment of not only color but also gamma and gamut. LUTs can also be used to monitor the input in a specific color space or more creatively to create a specific 'look' such as film stock emulation or to match cameras.



It's worth noting that not all LUTs are equal and the majority of LUTs are designed to work within the boundaries of REC.709. This means that whilst they may apply the color adjustments you are looking for they may also effect the luminance of the image and in which case these LUTs should only be used for delivery of content designed to be viewed in REC.709 or SDR. If you are working with 3D LUTs you can use color correction applications, as well as applications like Davinci Resolve, Photoshop or dedicated applications like LUTCalc. To create your own custom Looks that can then be imported to your Atomos device. They can provide a great base or primary grade that allow you to apply an instant look to your footage.

Atomos support 3D LUTs in the industry standard .CUBE format and provides 8 LUT memory slots for your load your LUTs into. 1D LUTs are not supported and will need to be converted via 3rd party software to be imported.

To import LUTs into your Ninja V first copy the .CUBE files on to the SSD/HDD in your Master Caddy II using a computer and compatible dock.

Load LUTs
from computer

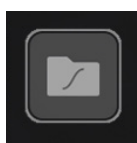

Add LUTs
To Ninja V

To load a LUT select the desired slot (curve button) and press on the curve icon and then tap the folder file. Navigate via touching through the disk file system to the LUT file to be uploaded, press on the name to select the LUT and then again to import.

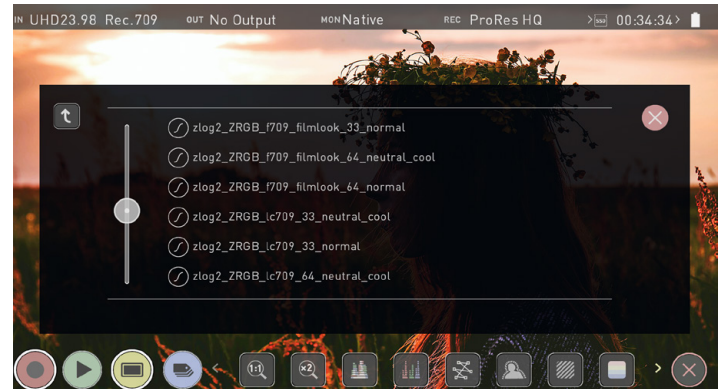
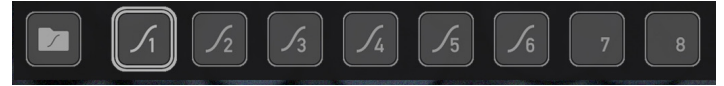

Then wait for the LUT loading progress bar to complete. The name of the currently selected 3D LUT is displayed at the top of the Monitor Mode panel.

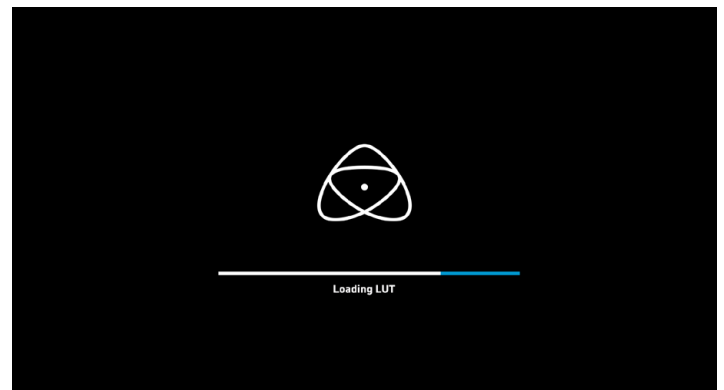

This LUT can then be applied to the display by selecting the correct LUT memory slot. **The LUT needs to be activated in the Monitor Features Menu.** Activating the LUT in the Monitor menu will always use the LUT selected in the LUTs menu. Touching the activated LUT name in the Information bar will give you instant access to LUTs selection.

Inside the LUTs menu touching on the slots will preview the name of the selected LUT (above the Menu bar). The selected LUT filename will also display in the Information bar.

9. Monitoring & Recording

3 options that relate to the processing of the LUT:

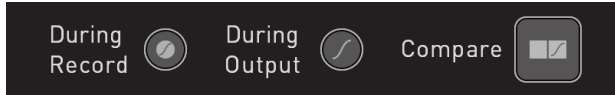

If this option is selected to the recording it will bake the LUT look into the recording and this is a **non-reversible process**. It cannot be undone in Post so we advise you consider your workflow before the use of this option. When enabled, a CUSTOM LOOK icon will flash in the top corner of the monitor and the LUT cannot be activated during recording to avoid any potential issues with the recorded content.

During Output

OUTPUT LOOK – With this option the selected LOOK is also applied to the HDMI loop out of the Ninja V. This will allow for instant preview on a larger monitor or to be used with a wireless sender. This function can also be combined with the down convert option that can be found in the input menu.

Compare

During color management it's likely that you may want to review a number of LOOKs and even compare them to the Native Video Source. Tapping the Compare option will apply a 50/50 vertical screen split that will show both the Natural Source Video and the selected LOOK of the LUT.



Please note that activating the 50/50 preview will also be applied to the Loop out and is not available when LUT is set to record.



Remember by simply tapping the center of the screen you can remove all overlays. Tap again to reveal controls.



Monitor

Before entering into the operation of HDR monitoring it is important to understand the background of HDR. We advise that you read the Atomos HDR Guide to familiarise yourself with the key terms and differences between the existing Rec.709 standard dynamic range (SDR) and the future way we will view images in High Dynamic Range (HDR).

Using Standards - Native / Rec.709 / HLG / PQ

AtomOS10 uses predefined settings to display your video when viewing in HDR. This is similar to the HDR slider in previous Atomos Operating Systems, except instead of a variable slider control, we now have buttons that correspond with Rec.709 (SDR), HLG and PQ (HDR) levels.

Activating these buttons will display your video according to the levels indicated below, allowing you to adjust your exposure accordingly and take the guess work out of exposing correctly for HDR.

Native Video Source

This option will display the video source without any processing and the Ninja V will behave as expected for a standard broadcast monitor. When connected to a camera this means the image you are viewing is the untouched camera output e.g.. a standard Rec.709 image or a Log image etc. A standard Rec.709 image will look correct and a Log image will look flat.

Rec.709

With this mode selected the Ninja V will map from the camera gamma/gamut so that 100% linear IRE maps the panel's white (1000nits). Everything above is clipped.

HLG (Hybrid Log Gamma)

With this mode selected the Ninja V will map from the camera gamma/gamut so that 1200% linear IRE maps the panel's white (1000nits). Highlights are slightly compressed.

PQ

With PQ mode selected the Ninja V will map from the camera gamma/gamut so that 2000% linear IRE maps the panel's white (1000nits). Highlights have more compression and look similar to HLG, but closer inspection will reveal more detail is visible in specular highlights.

Your camera's dynamic range will determine how much more detail is visible between HLG and PQ modes.

9. Monitoring & Recording

Understanding HDR and Log

The first step in HDR is to recognize you have a HDR scene. Look for a good range of contrast across the brightest and darkest parts of your image and also across the color and tonal range as each color also contains its own brightness or luminance information.

Secondly ensure you are sending a Log signal into the Ninja V so that you are recording the HDR Log information. For more information refer to the Video Input section.

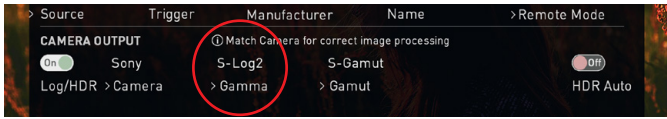

Now you are ready to capture Log and simultaneously use AtomOS10 image processing to preview the final HDR result in the field, rather than dealing with the washed out look of Log for critical exposure decisions.



The main impact of HDR is apparent in the specular highlights and bright areas. The areas that would have previously been 'blown out' will now contain visible detail and information to enhance your content. HDR provides more headroom allowing you to show more detail. Experimentation with increased exposures is encouraged.

AtomOS10 HDR uses an in depth understanding of each Log curve and combines it with the control of the panel processing and backlight in order to apply an increased brightness to the highlight areas of the scene.

Alongside the physical light in the scene, the faster/brighter your lens the greater the level of brightness you'll have to play with. Choosing a Cine style lens or those with a declicked manual aperture can provide increased flexibility over photo lenses that use an electronic control aperture.

The AtomOS10 monitoring mode allows the processing engine of the Ninja V to display the High Dynamic Range capabilities of a Log gamma input. HDR monitoring in AtomOS10 is the result of the research and development by Atomos that allows control of all aspects of the monitor through image processing to deliver the unclipped beauty of specular highlights through natural, vibrant colors with a result that allows you to simply shoot what you see. When the scene in front of you and the picture displayed on the Ninja look similar, your exposure should be correct but use in conjunction with the waveform monitor to verify.

One of the key elements to understand is that if your camera can shoot in Log then it can already capture the more dynamic range than you can display in SDR. Log preserves the highlight information by applying a Logarithmic curve to compress the additional stops of dynamic range to fit in to the Rec.709 standard. The image appears washed out and desaturated as each pixel contains more brightness information than SDR can display, if it were to do this it would be brighter than 100% Rec709 and so be clipped. This is illustrated below:

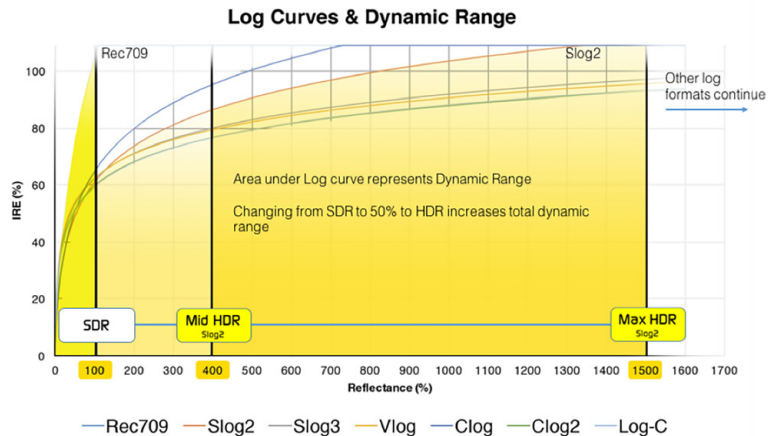

In addition to the SDR/HDR adjustments, the monitor tab provides the following options:



The **Display off** function allows for the screen to be turned off without affecting the operation of the unit. When enabled, the screen will turn off whenever you lock the display screen by tapping the power on/off button on the side of the unit. For more information refer to Screen Lock in the Using the Ninja V - Best Practice section.



The **Tally light** on the rear of the unit will still display red for record and the idle (green) status will be displayed on the front screen LED.



The **Flip screen** option allows you to invert the screen to meet your needs of operation.

Whilst the screen is inverted take note to respect the air flow and not to obstruct the cooling vents of the unit.

9. Monitoring & Recording

Display

With this mode selected you have the option to change the screen brightness by adjusting the slider when in Native mode. As you slide to the right the brightness will increase and when at 100% the image will be using the full 1000nits of the display. As with any electronic screen device increasing the brightness will increase the power draw and battery life will be effected accordingly.

Adjustments can also be made to the Lift, Gamma and Gain of the display. You can tap the icon on the left of the menu to scroll through the options and adjustments are again made by moving the slider left and right.



Backlight:

Adjust the strength of the backlight. Disabled during HDR monitoring

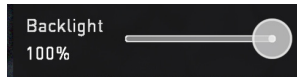

Lift:

Increasing lift will brighten the image and lessen the shadows

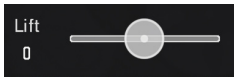

Gamma:

Gamma control allows you to create darker and richer shadows. This may be useful when monitoring in bright daylight conditions.



Gain:

Gain will boost the image brightness and affect the highlights

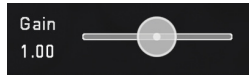

Reset:

Quickly return all values to default



File Recovery

The Ninja V continuously writes to disk while in recording mode. If the power fails or the drive is removed accidentally all but the last few seconds of the clip can be recovered.

In the event of an interrupted recording, when you restart the Ninja V, or enter playback mode, you will be presented with a menu that gives you the option to recover immediately, or recover it later.

If you select recover later, every time you put the disk in, or start up the Ninja V, the same menu will appear to prompt you to recover the file that did not close properly.

⚠ If the drive is broken, or has become corrupted, then we will not be able to recover the file and we recommend that you try third-party hard disk recovery software

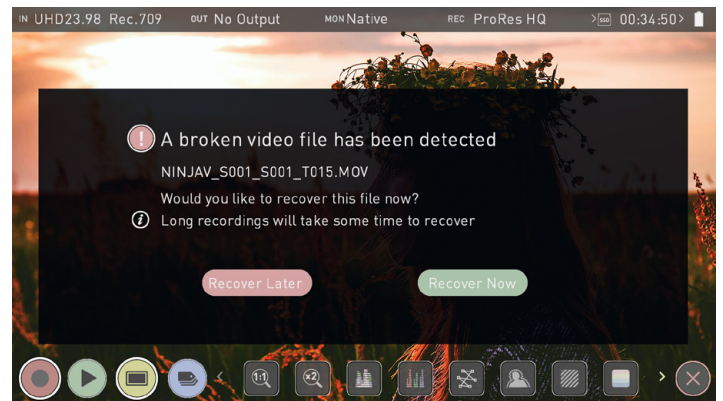

10. Playback & Playout

Playback mode

Pressing the Play button switches the device into playback mode and the last clip recorded on to the drive will instantly begin to playback.

Once within Play mode the complete Monitoring and Edit tool sets are available by tapping the buttons. Switch from Monitor to Edit tools by toggling the MON and EDIT buttons. Playback allows you to instantly analyze the content. This is key for establishing if takes are correctly focused, lighting has changed, or previewing recorded content with LUTs applied.

Clips/Playlist can be selected by tapping the folder icon in the lower right of the screen, or skip to the next or previous clip via the on screen controls.

Additional controls allow you to scrub through clips, set the playback speed and direction, as well as the ability to set the play mode to Loop.

All these functions can also be used in 'Playout' mode, and your footage can be viewed on a larger screen or monitor for review and appraisal. You can even apply Log curves and LUTs to your clips as they are played back.

Playback Mode / Home



Main Controls

- REC (Record):**
Jump to Record Home Screen
- PLAY:**
Play and pause the current clip
- MON (Monitor):**
Reveal/hide monitoring tools. Toggle on/off
- EDIT:**
Reveal/hide Edit tools. Toggle on/off
- Settings:**
Touch to access Playback settings and tools.
- Recorded Files**
Browse recorded files

Scrub bar | Speed/direction control

Controls are available during playback. Scrub forward and back. Set playback direction and speed. The percentage slider allows for you to set the playback speed. This is perfect for previewing high frame rate at half or quarter speed such as 60p at 30p in either forward or reverse directions.



2x/4x
Playback at 2x or 4x speeds both forward and in reverse.

Next/Previous
Jump to next or previous take.

Advance
Whilst a clip is Paused these buttons have the ability to step the clip by 1 second either forward or reverse to give you chance to analyze the clip in more detail, this is especially useful when combined with the 2:1 zoom function.

Loop
Tapping this icon, you can put the clip into loop playback. In and out markers for loop can be placed and cleared using the **edit tools**. For more information, refer to the Edit section.

10. Playback & Playout

Playback Mode

One of the key elements of the Ninja V is the ability to utilize the monitor recorder as a playback and playout device for the content that has been recorded whilst maintaining the same visually lossless high quality images. Ninja V's Playout capability also allows you to send the live and recorded footage out to a larger HDMI monitor or switcher.

 **Recorded Files**
Browse recorded files

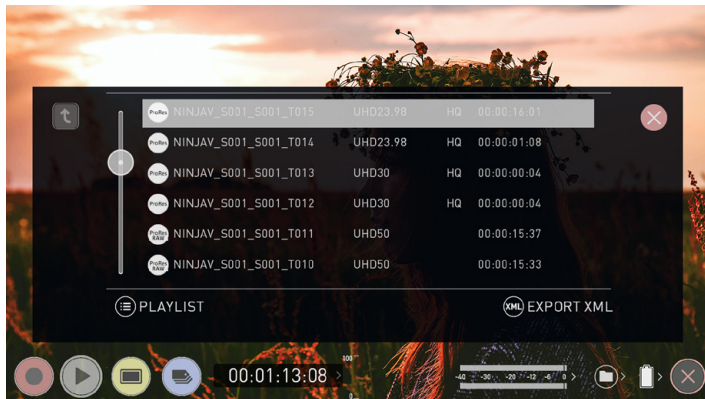

Pressing the filename or folder button will bring up a list of clips available on the drive. This will show clip name (with Scene shot Take numbers) as well as resolution, codec and duration Tap to highlight a clip, this will show a preview of the first frame in the background and tapping again or pressing play will play this clip.

 *When the playback content list menu is open playback will automatically stop.*

To play the selected clip touch the file name again.

Playlists

To increase the functionality and flexibility of the playback mode there is also the ability to create a Playlist. To build a Playlist open the Recorded Files folder, then press the Playlist button which will turn green and reveal the options available.

 *It's important to note that all clips in the Playlist must be in the same codec, resolution and frame rate.*

To return to normal playback of all recorded materials, press the Playlist icon again to deactivate the playlist.

The **Order Arrow** allows you to choose the order in which clips playback. The clips are stored based on the order they were recorded with the last



clip recorded at the top of the list. You can either play down the list (newest to oldest) or up the list (sequential order).

Tags

Press to scroll through the Playlist options.



All will play all clips on the disk.

Favorites will play only the clips that are tagged as favorites.

Combined will play only the clips that are tagged with favorite and the selected clips

Selected will play only those clips selected

 *The duration of each clip is combined together and are shown on the scrub bar in playback controls. A white vertical line indicates the start and end points and clips will seamlessly playback across those selected to be in the playlist.*

Codec Playlist

You can select which clips are played back by toggling the available codecs. Only clips of the same resolution, frame rate and codec are supported. The resolution and frame rate is indicated in the bottom right corner of the screen.



Favorite Playlist

The cut tag edit points can be combined with the favorites Playlist allowing the in and out points that have been created within the clip using the favorites flag to be used as sub clips within a Playlist. This means that if in and out points have been marked on a clip only those sections of the clip will play when used in a favorites or combined Playlist. Close attention should be paid to the order icon as this also relates to the sub clips as the run down order will play the last sub clip first in the Playlist.

 *Whilst a Playlist is in operation further metadata tags can not be applied to these clips.*

More information about using the In and Out points, tagging and XML Export is available in the Edit section.

10. Playback & Payout

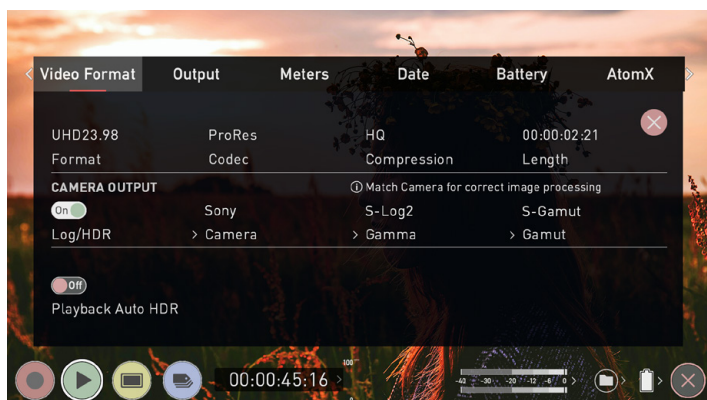

Video Format

Video Format

The Video Format menu contains information about the current settings of your Ninja V. The Format, compression rates and time remaining on your disk are displayed.

Format

Displays resolution and frame rate of the current clip.

Codec

Displays the codec of the current clip.

Compression

Displays compression settings for selected codec.

Length

Displays the total length of the clip.

CAMERA OUTPUT

Log/HDR

Turn on to enable HDR image processing inside the Ninja V.

Camera

Tap to scroll through to the manufacturer of the camera providing the input. Sony, Fujifilm, Canon, Panasonic, ARRI, RED and JVC.

Gamma

For each manufacturer there may be a number of different Log curves available and you can scroll through to the correct selection by tapping the Gamma icon.

Gamut

Select the Color Gamut of the input. This is not applicable to all cameras but again ensure that this matches the input of the camera to ensure accurate monitoring.

Playback Auto HDR

Engage this switch if you are feeding HDR images to the Ninja V from a camera or games console that supports HLG or PQ HDR output directly, using the appropriate metadata flags. If you are feeding Log video to the unit be sure that this setting is off.

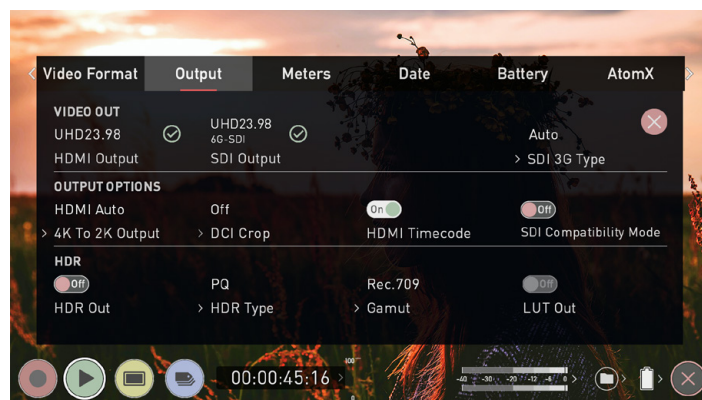

Output

Output

For information about this menu, refer to the Output section in the Using the Ninja V chapter.

Audio

Audio

For information about this menu, refer to the Audio section in the Using the Ninja V chapter.

Date

Date

For information about this menu, refer to the Date section in the Using the Ninja V chapter.

Battery

Battery

For information about this menu, refer to the Battery section in the Using the Ninja V chapter.

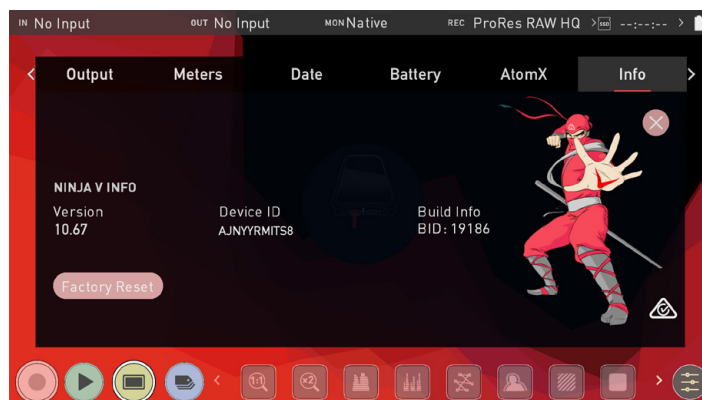

Info

Info

Shows the software (firmware) version and unique device ID (DID) of your Ninja V device. This will be required to activate the Apple ProRes RAW, Avid DNxHD / DNxHR and H.265 codecs as well as other features like SDI RAW on your Ninja V. You can also check on the Atomos website to ensure you are running the latest firmware: www.atomos.com/support

11. Edit

Edit mode

Edit mode allows you to tag your clips during recording and playback, as well as the ability to add in and out-points to recorded clips.

By the pressing the Favorite and Reject icons you can assign a "good clip" or "bad clip". This information can then be imported into a non-linear editing system to speed up the edit process. You can easily see which parts of your recording you have marked to keep or reject.

Favorite clips can easily be built into a Playlist in playback mode and these tagged sub clips can then be played out, back to back.





AtomOS10 has introduced extended tags to allow you to apply more specific tags that can help facilitate the edit.

 SmartLog is compatible with FCP XML (.fcpxml).

Playback Mode / Edit tools



Main Controls

-  **REC (Record):**
Press record to start recording
-  **PLAY:**
Play and pause the current clip
-  **MON (Monitor):**
Reveal/hide monitoring tools. Toggle on/off
-  **EDIT:**
Reveal/hide Edit tools. Toggle on/off
-  **SETTINGS:**
There are no user accessible settings available for Edit functions in the current AtomOS firmware. This may change with future firmware updates.

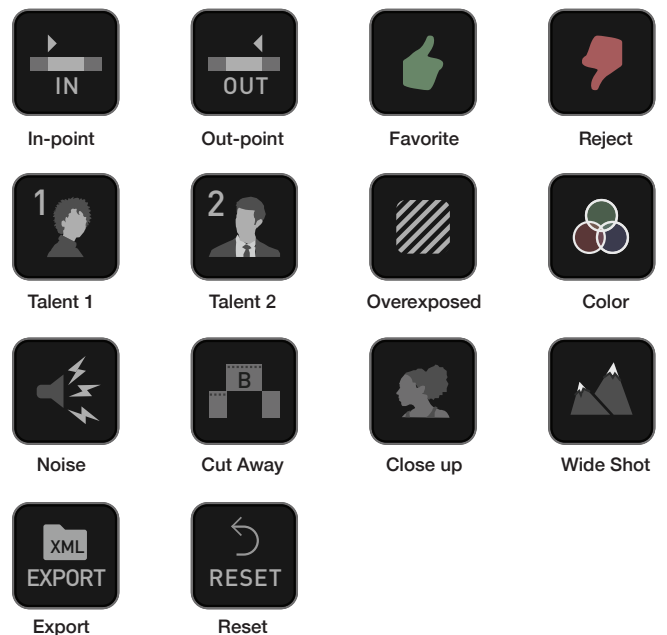

11. Edit

Markers and Tagging Icons (SmartLog)

Using Markers and Tags you can quickly start the editing and review process right here on your Ninja V, avoiding delays incurred when importing inferior and unwanted footage. You can review and tag immediately on-set with your client or director, or work through your takes without having to dump the recorded files to another workstation/NLE.



In-Point

Set the in-point by touching the button at desired point. Simply touch on to indicate in-point. Press a second time to reset in-point



Out-Point

Out-point can be set by simply tapping at desired out-point. To remove, tap again



Favorite

Mark the entire take as a favorite, or you can mark the parts of the take you wish to use. Apply multiple markers within one take if required



Reject

Mark the take/section as a reject



Talent 1

Tag talent or assign another meaning



Talent 2

Tag talent or assign another meaning, event etc.



Over Exposed

Tag clip as over exposed or out of focus



Color Correction

Tag clip as 'color'. Use tag to indicate a problematic image or even use for another purpose



Noise

Tag clip as containing background noise or interference



Cut Away

Tag clip as a cut away scene



Close Up

Tag clip as close up for use in edit and post



Wide Shot

Tag clip as wide shot



EXPORT XML

Once you clips have been tagged you can capture all the information and utilize the XML data to speed up your edit and post production time.

 SmartLog is compatible with FCP XML (.fcpxml).



RESET

Pressing the reset button will remove all tags and XML data from a clip. This can be useful when dealing with multiple takes or if a clip is tagged incorrectly. Reset will not remove or change in-point and out-point settings. To remove markers you will need to reset the in and out-points

Using Edit tools during recording, playback and monitoring

To access edit tools simply tap the Edit icon during record or monitoring.



In and Out points

Set in and out points easily during playback. Use the scrub control to accurately find the correct moment while the footage is paused.



Once markers are set, the footage will be clipped and only the enclosed footage will play. Reset markers to resume normal playback.

11. Edit



Favorite/Reject

Press Play and when you see the section of the footage you would like to mark as good or bad, press Favorite or Reject and then press again to stop marking that section. Multiple tags can be applied to your clips to provide Timecode accurate meta tags that can be exported to Apple FCP XML.



 A green or red line will appear in the timeline scrubbing bar so you can identify the region that has been selected.

Using Extended Tags



Aside from Favorite and Reject tagging options, AtomOS10 includes extended tags that will greatly assist your edit and workflow processes. Careful consideration and use of tags during monitoring and review can be highly beneficial when you are ready to begin post production.



The tags will be available upon import of the XML file and can be used to filter and display different parts of your recordings, depending on how you have used the tags to mark and edit the footage. More information about using tags and XML import can be found in the Connecting & Editing section.



Tags are also useful during playback and allow you to create Playlists featuring only selected recordings from your disk. More information about Playlists can be found in the Playback & Playout section. A full list extended tagging options appears the previous page.



Your final stage is to Export the tags to an FCP XML file:

- Press the EXPORT button



 SmartLog is compatible with FCP XML (.fcpxml).

- You will be shown a please wait screen (the length of time will vary depending on your recording time and amount of flags applied)
- Then it will return you to the previous screen.

A XML file has been created on your SSD/HDD and can be instantly accessed by FCP when the disk is connected to a computer using a compatible dock. For more information, refer to the Connecting & Editing section.



RESET

Pressing the reset button will remove all tags and XML data from a clip. This can be useful when dealing with multiple takes or if a clip is tagged incorrectly. Reset will not remove or affect in-point and out-point settings. To remove markers you will need to reset the in and out-points

12. Connecting & Editing

Connect

To access and edit your recorded material, connect the Master Caddy Docking Station to a Mac® or Windows® editing workstation via USB 2.0, USB 3.0 or USB-C 3.1.

Eject the Master Caddy or SSD mini from your Ninja V and insert it into the Docking Station. After a short wait, the recorded video will be accessible to the target computer via a standard disk (exFAT) file system.

NLE supported

We have chosen the Apple ProRes®, Avid DNxHD® and Avid DNxHR+ codecs as they are both not only visually lossless, but also edit-ready formats. All major NLEs support ProRes and DNxHD/DNxHR, and most support H.265 (HEVC). Please refer to the support documentation for your software for compatibility, especially with 10 Bit 4:2:2 H.265.

- Final Cut Pro (version 7)
- Final Cut
- Davinci Resolve 8.0 +
- Adobe CS5 (with 5.51 update or later)
- EDIUS 6
- Vegas 10
- Lightworks
- Avid Media Composer 6 (version 8.3 or later for DNxHR)
- Autodesk Smoke

 *The Master Caddy Docking Station is a sophisticated device supporting two different data interfaces: USB 2 and USB 3. When using the Master Caddy Docking Station you may need to connect both USB connectors. This is because when it has to power a disk drive and its interface electronics, the Docking Station may consume more power than is available from a single USB port.*

ExFAT compatibility

The Ninja V formats your disk as exFAT. We have chosen this file system to overcome the 4GB file limitation of FAT32 and keep compatibility on both Windows and MAC OS.

The Operating Systems that support exFAT are:

- Windows 10
- Snow Leopard 10.6.5 or higher
- Lion 10.7
- Mountain Lion 10.8
- Mavericks 10.9 and above

Transferring files

Now your docking station is connected and your disk is recognized by your operating system, you can edit directly from the drive or copy the files to your own storage.

Windows

Open the disk in My Computer > Select all the files or just the ones you wish to transfer, copy and paste them to your desired location. (ctrl+c copy, ctrl+v paste).

Mac OS

Your Ninja V disk will show in Finder. Select the files you wish to transfer, drag the files to your desired location or use the copy and paste commands. (COMMAND + C copy, COMMAND + V paste).

 When using the AtomX USB-C 3.1 Docking Station II with older computers a USB 3.0 Male to Type C Female adaptor is required.



Attach AtomX SSDmini or Master Caddy



Ensure disk is properly attached

12. Connecting & Editing

SmartLog with FCP

Prior to importing the XML files into FCP, ensure that:

- You have exported XML whilst the drive is in your Ninja V
- You have connected your Master Caddy Docking Station and inserted your Master Caddy into the Dock
- You are using an operating system that supports ExFAT
- Your QuickTime version is up to date
- FCP is the latest version

There are 2 ways to import the XML file:

1. Directly from the docked hard drive
2. Manually into FCP

1. Automatic Import

- Open Finder
- Select the drive (in this example it is EXCVIDEO)
- Double-click the unitname.FCPXML file
- This will open FCP and import the .xml file

FCP will make a event of the disk, name and reference all the footage in that event.

You will notice that on the clips you have added Smart Tags too, with Green and Red indicating Favorite and Reject.

You can sort these by using the pull-down menu to show favorites.

This will show all the individual favorites as separate clips in the Event Viewer.

2. Manual

- Open FCP
- Create a New Project (or you can use an existing project); in this example it is called XML Import
- Select File, Import, XML

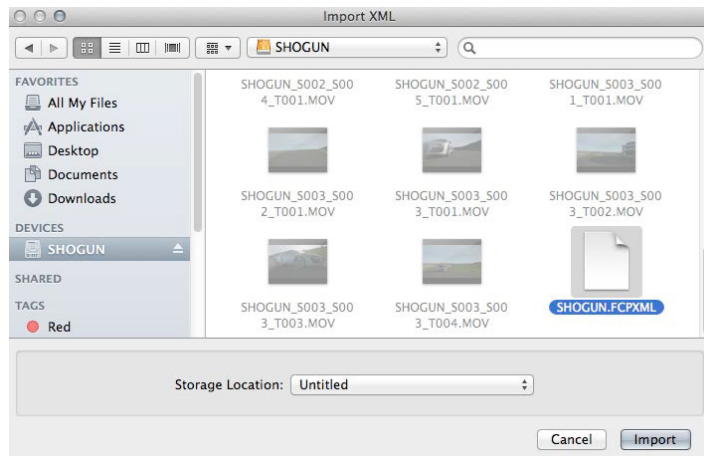

- Select the Ninja V drive under Devices (in this example it is called EXCVIDEO)
- Choose the unitname.FCPXML, select Import

The XML will import

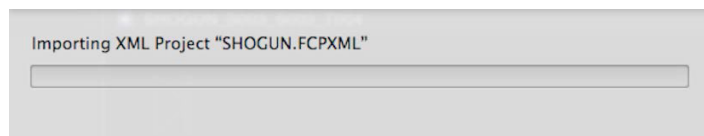

Once imported you can expand the clip and you will see the Favorite, Reject and other various tags. You can also filter the view to only see specific tags e.g.. favorite, etc.

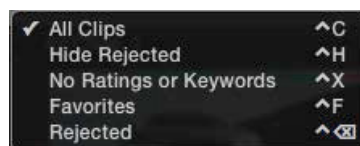
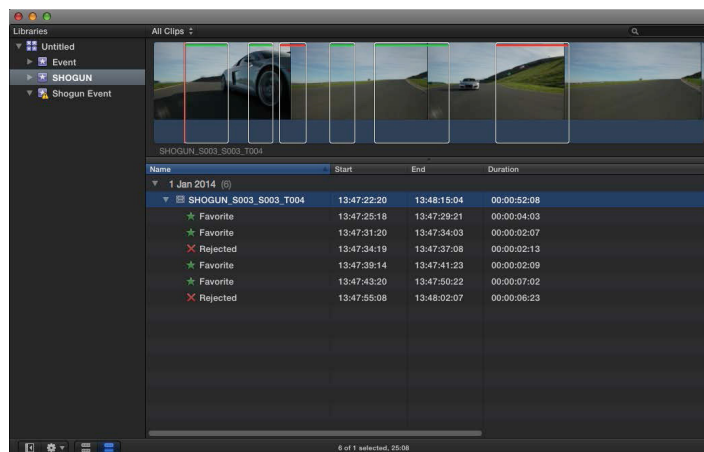

12. Connecting & Editing

Adjusting ProRes RAW settings in Final Cut Pro

Final Cut Pro allows you to view and adjust the camera settings of ProRes RAW files, like ISO, exposure offset and color temperature in the Inspector tab. The settings that can be adjusted will depend on the camera used with your Ninja V to record ProRes RAW clips. For more information on the cameras supported and the settings that can be adjusted, refer to this Apple Support Article: <https://support.apple.com/HT204203>

How to adjust ProRes RAW camera settings in Final Cut Pro

1. After importing your Apple ProRes RAW clips, select the clip(s) that you want to adjust in the browser or in the timeline.

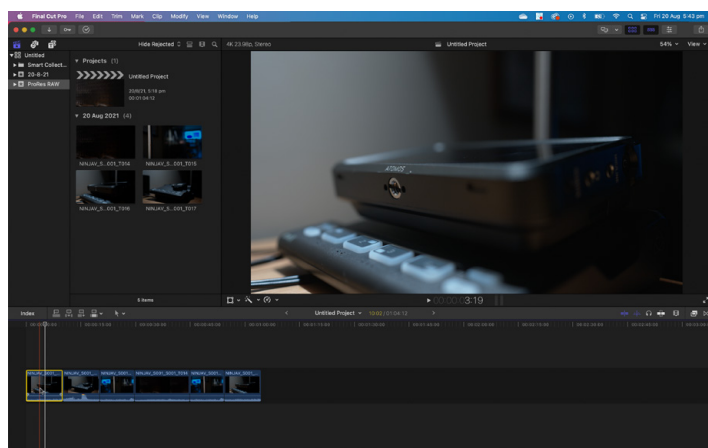

2. Open the Inspector by clicking on Window>Show in Workspace>Inspector

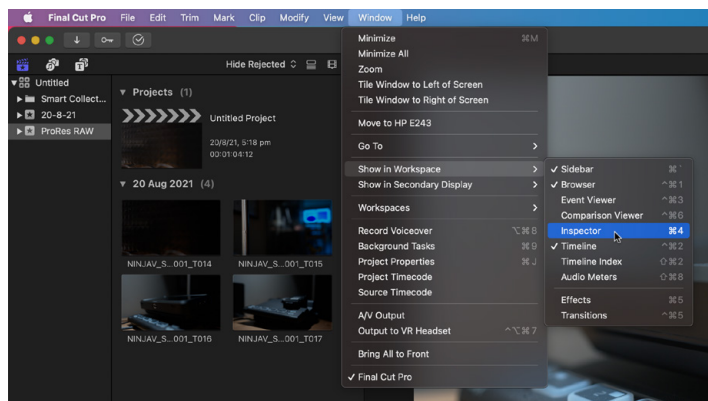

3. Click on the Info button in the Inspector to show the Info Inspector

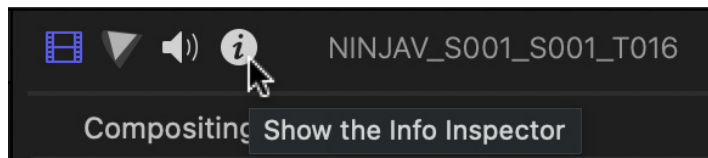

4. Click on the word Basic at the bottom of the Info Inspector tab to open the Metadata View pop-up menu, and select Settings.

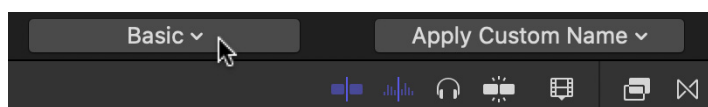

5. The Info Inspector will now display the camera settings of the ProRes RAW clip(s).

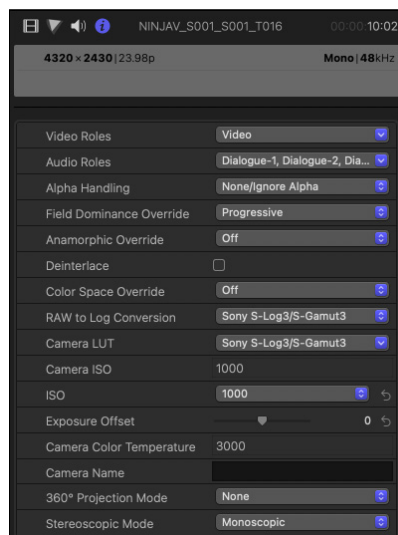

Camera ISO

Displays the ISO setting selected in camera during the recording of the selected ProRes RAW clip(s). This is for information purposes only and is not adjustable.

ISO

This drop-down menu allows you to adjust the ISO setting for the selected clip(s).

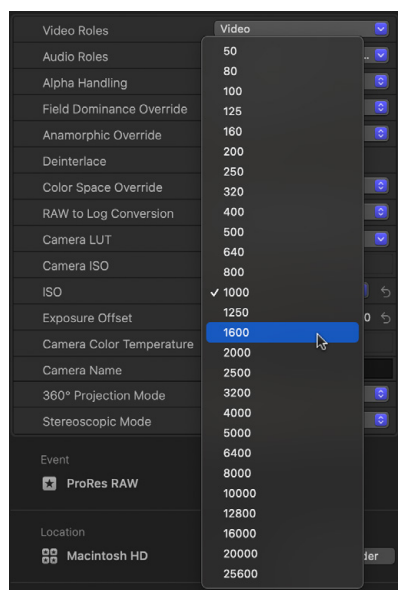

Exposure Offset

Adjusts the ISO setting up or down by as much as one stop.

Camera Color Temperature:

Displays the color temperature setting selected in camera during the recording of the selected ProRes RAW clip(s). This is for information purposes only and is not adjustable.

Temperature

Adjusts the color temperature setting for the selected clip(s). This slider only appears where the camera used to record the ProRes RAW clip(s) supports color temperature adjustments.

For more information on the cameras supported and the settings that can be adjusted, refer to this Apple Support Article: <https://support.apple.com/HT204203>

13. Technical Specifications

Physical Specifications	
Without batteries & media	360g / 12.7oz
Dimensions (W x H x D mm)	151 x 91.5 x 31.5mm
Mounting points	1 x Anti rotation 1/4" / 3/8 top and bottom
Environmental	
Ambient operating temperature	Up to 40° C
Construction and Control	
Body	Aluminium with ABS plastic
Cooling	Actively controlled fan and heat sink
Tally light	Rear and front
Multi-function button	Power / lock Screen
AtomXpansion slot	Yes
Power	
Touchscreen	SuperAtom IPS panel (capacitive touch)
Operating power	5.8V - 7.2V
Compatible batteries	NPF L series
Input voltage (battery)	6.2V to 16.8V
Battery time (based on 7.4V)	5200mAh - up to 2hrs (monitor & record 4Kp60) 7800mAh - up to 3hrs (monitor & record 4Kp60)
DC In	Via DC Jack on Battery Eliminator
Continuous power	Via Optional AtomX SYNC Module
DTap	Via Battery Eliminator and optional DTap to DC cable
Display	
Size	5.2"
Resolution / PPI	1920 x 1080
PPI	427
Bit Depth	10Bit (8+2 FRC)
Backlight Type	Edge lit
Brightness (cdm2 / nits)	1000
Aspect ratio	16:9 native
Color Gamut	REC:709
Calibration support	Atomos Calibrator with Calibrite ColorChecker Display Pro and Display Plus
Color Pipeline	
AtomHDR	Yes
Gamma	Sony SLog / SLog2 / SLog3, Canon CLog / CLog2 / Clog3, Arri Log CEI160 / LogCEI200 / LogCEI250 / Log-CEI320 / LogCEI400 / LogCEI500 / LogCEI640 / LogCEI800 / LogCEI1000 / LogCEI1280 / LogCEI1600, Panasonic Vlog, JVC JLog1, Red LogFilm / Log3G10 / Log3G12, FujiFilmFlog, PQ (HDR10), HLG, Nikon N-Log
Gamut	BT2020, DCI P3, DCI p3 65, Sony SGamut / SGamut3 SGamut3.cine / Canon Cinema / DCI P3 / DCI P3+ BT2020 Panasonic V Gamut, Arri Alexa Wide Gamut, Rec709, JVC LS300, Red DragonColor /DragonColor2 RedColor2 /RedColor3 / RedColor4 RedWideGamut

3D LUT Display	.Cube Format
3D LUT Down Stream	Loop out
3DLUT 50/50	Yes
Monitoring Modes	Native / HLG / PQ / 3D LUT
HDR output Conversion	Log / HDR to HLG / PQ / Dolby Vision
Video Input	
HDMI	1 x HDMI (2.0) 4Kp60
HDMI RAW	Apples ProRes RAW up to 6K
SDI	Optional via AtomX SDI module
SDI RAW	Optional with AtomX SDI + SDI RAW activation
Bit Depth	8/10-bit Video / RAW up to 16-bit
Video Chroma Subsampling	4:2:2
HDCP copy protection	Not supported
Metadata	
HDMI	RAW - white balance, exposure index, shutter speed/ angle, iris F stop, ISO, gamma, gamut
SDI	File name from Arri, RED
Video Output (Playout)	
HDMI	1 x HDMI (2.0) 4Kp60
SDI Loop Out	Optional Via AtomX SDI module
SDI Play Out	Optional Via AtomX SDI module
Video Chroma Subsampling	4:2:2
Bit Depth	10Bit Video / 12Bit RAW
Web Streaming	
USB UVC	Optional via Connect 4K
Video Signal Conversion	
HDMI to SDI	Optional Via AtomX SDI module
SDI to HDMI	Optional Via AtomX SDI module
Audio In/Out	
Audio Quality	24/48kHz
Audio Codec	PCM
HDMI	8ch 24-bit, input dependent
SDI	12ch 24-bit, input dependent
Analogue Audio in	3.5mm 2ch.
Headphone out	3.5mm 2ch.
Timecode / Sync	
Embedded	HDMI and SDI
Time of day	Yes, Time and Date
LTC	via 3.5mm audio Jack input (requires post processing)
Wireless SYNC	Via Optional AtomX SYNC Module

13. Technical Specifications

Resolution and Frame Rates (Record, Monitor & Playback)	
6K	RAW Only up to 30p via HDMI
4K DCI	23.98/24/25/29.9/30/50/59.94/60p
4K UHD	23.98/24/25/29.9/30/50/59.94/60p
2K DCI 2046 x 1080	Optional via AtomX SDI module
Anamorphic	3.5K: RAW up to 60p (from supported cameras only)
FHD 1920 x 1080 Progressive	23.98/24/25/29.9/30/50/59.94/60/100/120p
FHD 1920 x 1080 PsF	Converted to P and looped out PsF
FHD 1920 x 1080 Interlaced	23.98/24/25/29.9/30/50/59.94/60i
1280 x 720p	50/59.94/60p
Recording Codec	
Apple ProRes RAW	ProRes RAW, HQ
Apple ProRes	LT, 422, 422HQ
Avid DNxHD	220x, 220, 145, 36
Avid DNxHR	LB, SQ, HQ, HQX
H.265	Optional activation key visit my.Atomos.com
Playback	
Playlist	Yes, Create customer play lists from full or sub clips
Loop	Yes, with user customizable in / out markers
Apple ProRes RAW	Yes, recorded clips
Apple ProRes	Yes, with Linear PCM audio
Avid DNx	Yes, with Linear PCM audio
Recording functions	
Pre-roll record	Yes (HD 8s, 4K 2s) - Not available in RAW
Timelapse	Yes
Multi Input / Switching	
SDI A/B toggle	Via optional AtomX SDI module
Supported media	
Master Caddy I	Not Compatible
SSDmini	Native size and fit
CFast II	Supported cards via optional AtomX CFast Adapter
File Naming	Unit Name - Scene/Shot/Take
File System	ExFAT
On Screen Tools	
Waveform	Yes, 3 size / position
RGB parade	Yes, 3 size / position
Vector scope	Yes, 3 size / position
1 x Zoom	Yes. 1:1 Pixel mapping for 4k
2 x Zoom	Yes
Focus peaking	Color selected / threshold setting / color / mono / edges only

False color	Yes, with scale
Zebra	Yes, adjustable
Isolate color channel	Blue Only
Cine Frame Guides	2.4:1, 2.35:1, 1.9:1, 1.85:1, 4:3
Social Frame guides	9:16, 1:1, 1.91:1, 4:5
Safe areas	Action and Graphic
Grid markers	9 grid
Anamorphic desqueeze	1.25x 1.33x , 1.5x ,1.8x ,2x
Display Flip	Vertical Only
Onboard Signal Processing	
Pull-down Removal	24/25/30pSF > 24/25/30p (2:2 pull-down) 60i > 24p (3:2 pull-down)
4K UHD Downscale for HD	Loop out - 4K UHD to FHD
DCI Crop	Loop out - 17:9 to 16:9 Crop
Remote control	
HDMI	Auto HDMI Trigger, Supported Protocols - Canon, Sony, Atomos Open Standard
SDI	SDI trigger camera selectable
Serial 2.5mm Jack	LANC control and calibration via optional USB to serial cable
Bluetooth LE	Via optional AtomX SYNC module
Wireless RF	Via optional AtomX SYNC module
External Device Control	
Serial 2.5mm Jack	Camera control for supported cameras via Optional USB to Serial Cable
Bluetooth LE	Via optional AtomX SYNC module to compatible devices
Wireless RF	Via optional AtomX SYNC module to compatible devices
Supported Applications	
XML	Cut tag EDL in FCPX XML
Apple ProRes RAW	Apple FCP, Adobe Premiere, After Effects, Avid Media Composer, GrassValley Edius, Assimilate Scratch, Baselight Film Light.
Video Codecs	All Applications with support for Apple ProRes and Avid DNx in .MOV wrapper
What's in the box	
Accessories included	Ninja V, 1 x Battery eliminator, 1 x international DC power supply, 1 x MasterCaddy II and QuickStart Guide
Optional extras	5" Accessory kit, Sunhood, DC to DTap, Power Kit, HDMI cables, USB to serial cable, AtomX SYNC module, AtomX SDI module
Warranty	
Standard	1 year. Extended to 3 years on product registration

Construction note: Your Ninja V is designed to operate in ambient temperatures up to 40°C/104°F. If you wish to extend the temperature of operation in high temperature conditions, you can choose an SSD drive, and set the TFT brightness to a minimum.

Please note: Specifications are subject to change without notice. All information assumed correct at time of publishing.

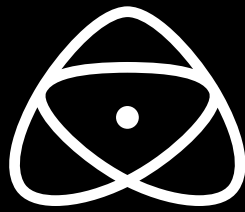

atomos.com

 /atomosglobal

 @atomos.global

 @AtomosGlobal

 /AtomosVideo