

DeckLink User Manual for Windows XP™

Fourth Edition.
November 2004



Windows XP™



Windows XP™

Welcome



Thank you for purchasing a DeckLink broadcast video card. We hope you share our dream for the television industry to become a truly creative industry by allowing anyone to have access to the highest quality video.

Previously high end television and post production required investment in millions of dollars of hardware, however with DeckLink cards, even 10 bit uncompressed is now easily affordable. We hope you get years of use from your new DeckLink card and have fun working with some of the world's hottest television and design software!

This instruction manual should contain all the information you'll need on installing your DeckLink capture card, although it's always a good idea to ask a technical assistant for help if you have not installed hardware cards into computers before. As DeckLink uses uncompressed video and the data rates are quite high, you'll need fast storage and a high performance host computer.

We think it should take you approximately 15 minutes to complete installation. Please check our web site at www.blackmagic-design.com and click the support page to download the latest updates to this manual and DeckLink driver software.

Lastly, please email us (register@blackmagic-design.com) with your DeckLink serial number so we can keep you updated when new software is released. Perhaps you can even send us your latest show reel of work completed on your DeckLink!

We are constantly working on new features and improvements, so we would love to hear from you!

Grant Petty
CEO Blackmagic Design

Contents

Welcome	2.
Storage and data rates for uncompressed video	3.
Standard Definition Windows system requirements	4.
High Definition Windows system requirements	5.
Hardware installation	6.
Blackmagic DeckLink software	7.
Pre-installation checks	8.
Installing Blackmagic DeckLink software	9.
Getting connected	11.
Processor Amplifier	13.
VANC	13.
Genlock	13.
Blackmagic Deck Control	15.
Blackmagic LiveKey	17.
Hardware Down-Conversion with DeckLink HD Pro	18.
Switching to 4:4:4 mode with DeckLink HD Pro	18.
Adobe After Effects	19.
Adobe Premiere Pro	20.
Trouble Shooting	22.
If things go wrong	23.
Connection diagrams	
DeckLink	24.
DeckLink Pro	25.
DeckLink SP	26.
DeckLink Extreme	27.
DeckLink Extreme cables	28.
DeckLink HD	29.
DeckLink HD Pro 4:4:4 mode	30.
DeckLink HD Pro 4:2:2 mode	31.
DeckLink HD Pro (Single Link)	32.
DeckLink HD Pro cables	33.
Blackmagic Design Warranty	34.

Storage and data rates for uncompressed video

The data rates for uncompressed video are quite high, and listed below are minimum recommended disk requirements for uncompressed standard definition and high definition video.



Windows XP™

Uncompressed 10 bit YUV (4:2:2)

Standard Definition

Frame Size	MB per second	MB per minute	GB per hour
720x486/29.97fps	27	1 600	94
720x576/25fps	26	1 582	93

High Definition

Frame Size	MB per second	MB per minute	GB per hour
1280x720p/60fps	141	8 438	494
1920x1080/24PsF	127	7 594	445
1920x1080/50i	132	7 910	463
1920x1080/60i	158	9 482	556

Uncompressed 10 bit RGB (4:4:4)

High Definition

Frame Size	MB per second	MB per minute	GB per hour
1280x720p/60fps	211	12 656	742
1920x1080/24PsF	190	11 391	667
1920x1080/50i	198	11 865	695
1920x1080/60i	237	14 238	834

Due to disk seeks, when calculating the data rates required for your disk system, it is a good idea to add a safety margin due to fluctuations in disk speed. The degree of margin can be reduced by adding more disks.

Serial ATA (SATA) disks can reduce to half their speed as they become full, so in a 2-disk SATA array you should aim for a 100% safety margin. In an 8-disk SATA array, a 30% safety margin should be adequate. SCSI disk arrays seem to display less fluctuation and so a 20% safety margin should be adequate for an 8-disk SCSI array. Generally the more disks in the array, the better.

Note: Although other vendors and third parties may provide different data rates for uncompressed video, the above recommendations are tested for use with Decklink cards.

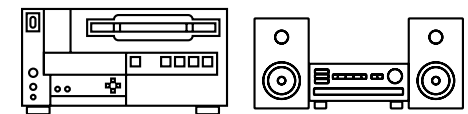
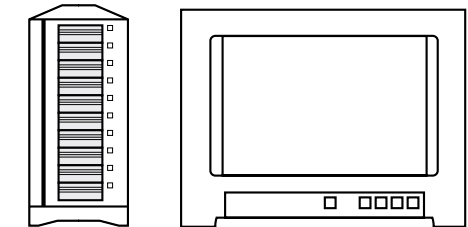
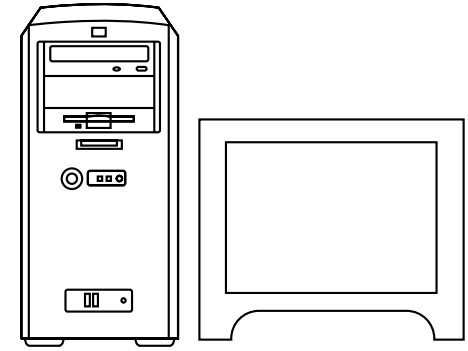



Windows XP™

Standard Definition on Windows™ Minimum system requirements

Operating System

Microsoft Windows XP® Pro with service pack 1 or later
[Microsoft Windows 2000® and Server 2003 are not supported]

Hardware

Processor

- Intel Dual Xeon 2.8GHz or higher for Intel 7505/7525 chipset based systems
- Intel Pentium 4 3.0 GHz or higher for Intel 875p chipset with 800MHz FSB

Motherboard

- Intel 7505/7525/875p chipsets – These include motherboards such as Supermicro X5DAE, X5DA8, X6DA8-G2 and P4SCT+II

PCI slots

- 64 bit PCI 33/66 MHz or PCI-X slots 100/133MHz

Memory

- 2 GB ECC 2100 RAM or DDR 400/333/266 SDRAM for 875p chipsets

Graphics card

- AGP x 8 Graphics card (Not Matrox)
- PCI E x 16 (Nvidia FX1300)

Disk Arrays

- SCSI - Ultra 160 or Ultra 320 SCSI card (either PCI or onboard); with at least 2 x U160 or U320 SCSI disks, 10 000 rpm, software striped as RAID [0], OR;
- SATA - SATA RAID card (either PCI or onboard); with at least 2 x SATA disks, 10 000 rpm, software striped as RAID [0].

Note: If using Intel 875p chipsets, make sure that the motherboard has 64 bit PCI slots. 32 bit PCI slots are not recommended or supported.

Standard Definition Monitoring

For monitoring Standard Definition and High Definition video, check out Blackmagic Design's low cost HDLink. HDLink converts your SD and HD-SDI output to DVI-D, perfect for use with LCD displays such as the Apple HD Cinema™ 23" display. HDLink features 2 x resize of NTSC and PAL on 1920x1200 pixel displays and also provides analog RCA audio output.

For more information on HDLink visit www.blackmagic-design.com



DeckLink™



DeckLink Pro™



DeckLink SP™



DeckLink Extreme™





Windows XP™

High Definition on Windows™ Minimum system requirements

Operating System

Microsoft Windows XP® Pro with service pack 1 or later
[Microsoft Windows 2000® and Server 2003 are not supported]

Hardware

Processor

- Intel Dual Xeon 2.8GHz or higher

Motherboard

- Intel 7505/7525 chipset – This includes motherboards such as Supermicro X5DAE, X5DA8 and X6DA8 - G2

PCI slots

- 64 bit PCI-X slots 100MHz and 133MHz

Memory

- 2 GB ECC 2100 RAM

Graphics card

- AGP x 8 Graphics card (Not Matrox)
- PCI E x 16 (Nvidia FX1300)

Disk Arrays

- SCSI - Ultra 320 SCSI card (either PCI or onboard), with at least 8 x U320 SCSI disks, 10 000 rpm, software striped as RAID [0], OR;
- 2GB fibre Channel
- SCSI card recommendation - Adaptec 39320 series

Note: Check the Blackmagic Design website for updates on hardware compatibility at www.blackmagic-design.com and “click on the support page.”

High Definition and Standard Definition Monitoring

For monitoring high definition and standard definition video, check out Blackmagic Design's low cost HDLink. HDLink converts your HD and SD-SDI output to DVI-D, perfect for use with LCD displays such as the Apple HD Cinema™ 23” display. HDLink features 2 x resize of NTSC and PAL on 1920x1200 pixel displays and also provides analog RCA audio output.

For more information on HDLink visit www.blackmagic-design.com



DeckLink HD™

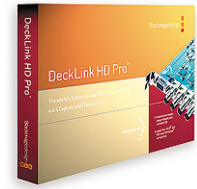

DeckLink HD Pro™





Windows XP™

Hardware installation

1. Remove the power plug from the back of your PC. This is a safety precaution before opening your computer. Ensure that you are statically discharged by using a static strap.
2. Remove the side cover of your PC to gain access to the PCI slots.
3. Remove your DeckLink card from the protective static bag making sure you don't touch the gold connectors on the base of the card. These precautions should be taken when handling any PCI card.
4. Find a spare PCI or PCI-X slot (DeckLink HD series cards require a PCI-X slot). Remove the metal port access cover, and screw, from the back of your PC.
5. Insert your DeckLink card and ensure that it clicks into place.
6. Secure the card by the screw or clamping device.
7. The procedure for installing a RAID controller card is similar to the above (The RAID controller card should be installed into a 100MHz PCI-X slot.)
8. Now replace the side cover of your PC. Reconnect the power and start up the computer.

Note: If installing DeckLink HD or DeckLink HD Pro make sure you use the 133MHz PCI-X slot.

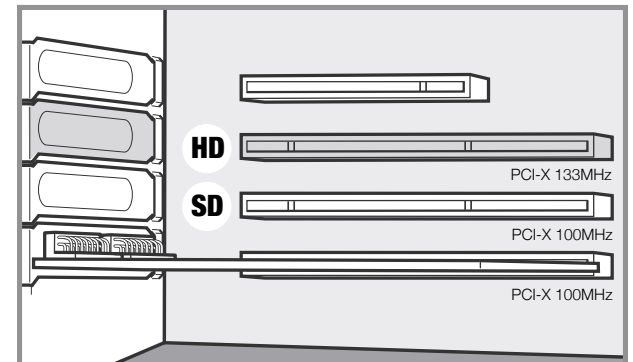
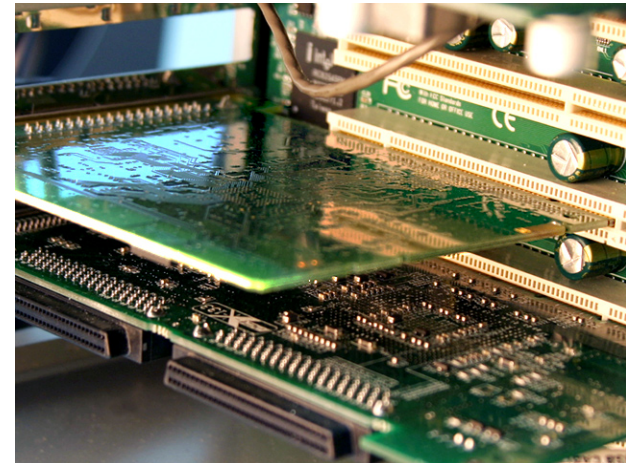



Windows XP™

Blackmagic DeckLink Software

The Blackmagic Design software installer supports standard and high definition video formats and all Blackmagic Design DeckLink PCI cards.

The Blackmagic DeckLink software installer will install the following components.

1. Blackmagic DeckLink drivers.
2. Blackmagic Deck Control application (for QuickTime™).
3. Blackmagic DeckLink control panel.
4. Blackmagic QuickTime™ codecs.
5. Adobe Premiere Pro® plug-ins and presets.
6. DirectShow™ filter for capture, playback and conversion.
7. Blackmagic Disk Speed Test.

Note: Before installing any software or hardware you will need administrator privileges.

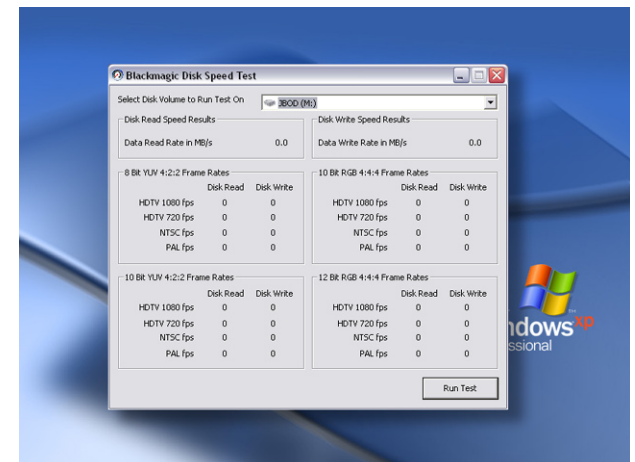
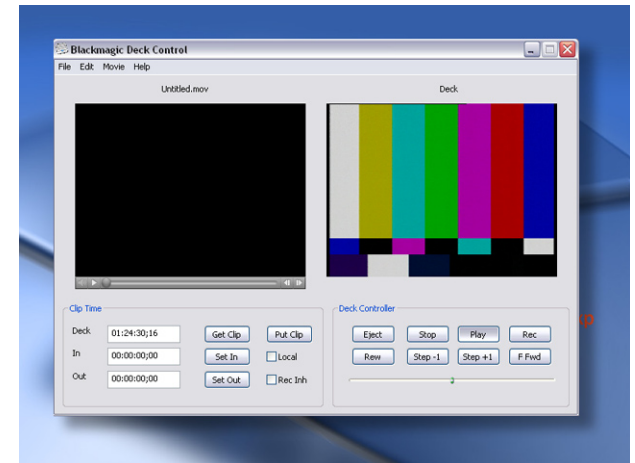

Pre-installation checks

SCSI Devices

Some SCSI cards/onboard controllers have their own utilities. Adaptec SCSI cards have a utility that can be accessed before the BIOS starts up when powering on your PC. Use “control A” to access SCSI utilities.

If you intend to run your disk array as a software stripe you will need to make sure that ‘host RAID’ is disabled. Use the “Disk Management” tool in “Computer Management” within Windows XP™ to set up your software RAID, or refer to third party instructions when using pre-configured hardware RAID. Onboard SCSI controllers can also be used.

QuickTime™

Make sure the latest version of QuickTime™ is installed on your PC. QuickTime™ can be found at www.apple.com/quicktime

Software Applications

DeckLink cards work with applications such as Adobe Premiere Pro®, Adobe After Effects® and Discreet Combustion™. The DeckLink installer will install components into some of these applications. If you install or update these applications after installing your DeckLink card, you should reinstall the DeckLink drivers to ensure these applications will work with your DeckLink card. Having software applications pre-installed will simplify the installation of your DeckLink card.

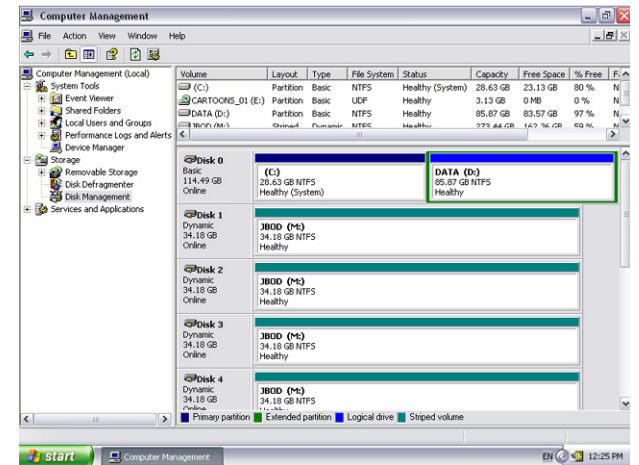



Windows XP™

Installing Blackmagic DeckLink software

1. When the Windows XP™ desktop loads, the Windows hardware wizard will automatically appear. Click on “cancel.”
2. The CD supplied with the DeckLink card contains the Blackmagic installer. In order to ensure that you have the very latest driver please visit www.blackmagic-design.com and click on the support page. Note: Should the installer on the website be a newer version than the one on your installer CD, download and save the zip file for future installations.
3. Go to the location of the downloaded installer and double click the self extracting zip file.
4. Now double click on the DeckLink Installer. All DeckLink cards use the same installer.
5. The drivers will now be installed on your system. A warning will appear that “this software has not passed logo certification to run on Windows XP.” Click “continue” and ignore this warning.
7. You will see a dialog bubble saying “found new hardware”, and the hardware wizard will appear. Select “install automatically” and the system will find the required DeckLink drivers. You will then receive another dialog bubble saying “your new hardware is ready for use.”
6. Now restart your machine to enable the new software drivers.

Note: Keep the installer handy, as it has the added feature of being able to “repair” or “remove” the driver if required.

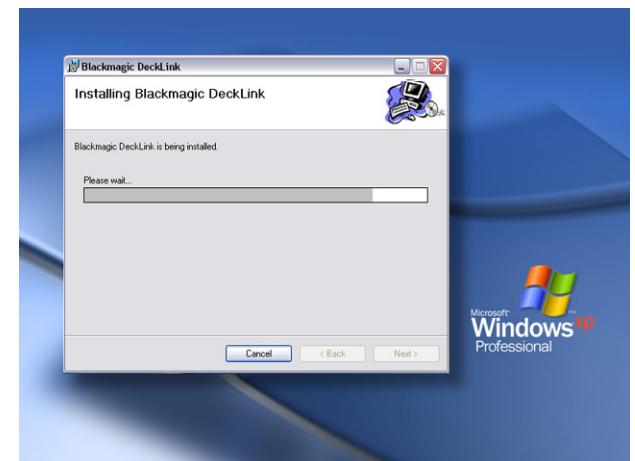
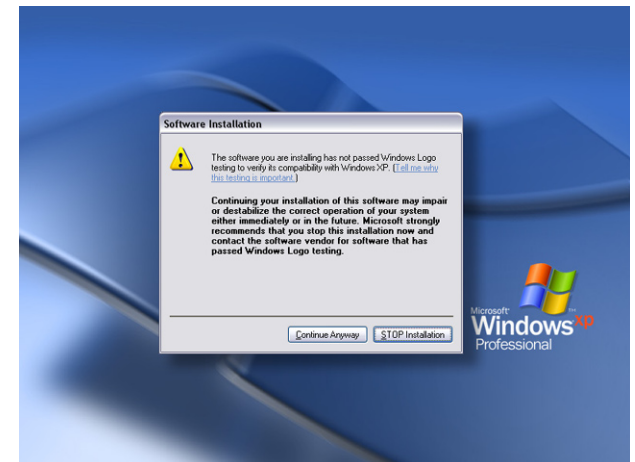



Windows XP™

8. Now restart your machine to enable the new software drivers.
9. To check the installation has been successful, right click on “my computer” -> **manage -> device manager -> display adaptors**. There should be two display adaptors. One will be your AGP card such as NVIDIA or ATI, and the other will be your DeckLink card.
10. When updating to the latest Blackmagic drivers “uninstall” the current version you are using. You can do this from control panels -> **add or remove software -> Blackmagic DeckLink -> remove**. Then run the latest installer.
11. Select where sound is routed when playing and capturing QuickTime™ movies. Open the QuickTime™ control panel, pop up the “Sound Out” menu and choose SDI Digital Audio. Switch the pop up menu to “Sound In” and choose SDI Digital Audio. The settings should be 48 kHz, Stereo and 16 bits. “SDI Digital Audio” should be chosen even when using analog audio with cards such as DeckLink SP and DeckLink Extreme. Analog converters on the analog DeckLink cards ensure the audio is converted to and from analog or digital as required.

Important Note

Viruses are an ever-increasing problem on computers. Computers will often slow down if they become infected. This can cause various problems in video, especially dropped frames and stuttering audio. For this reason, we recommend you dedicate your PC to video work and avoid using it for other tasks which may introduce viruses, e.g. email, web browsing and sharing of ejectable disks such as USB disks and non-commercial CD's & DVD's.

It is good practice to run antivirus software and keep it up to date. However, the memory-resident component of many antivirus products is likely to cause your video to drop frames. Accordingly, we recommend disabling the memory-resident component of your antivirus software while performing any video or audio work. Most antivirus programs show an icon in the Windows Taskbar and clicking (or right-clicking) on this icon will usually reveal an option to disable automatic virus protection. Disable the automatic protection (“memory resident protection”) while working on video or audio.

If you are also going to use your PC for purposes other than video or audio work, it would be wise to re-enable the automatic virus protection whenever you have finished your video and audio work.

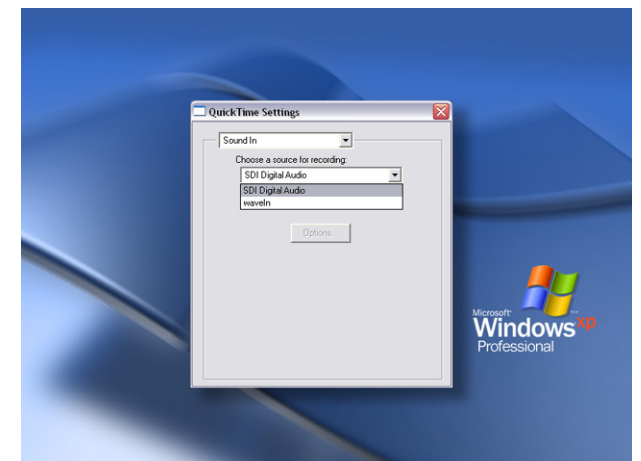
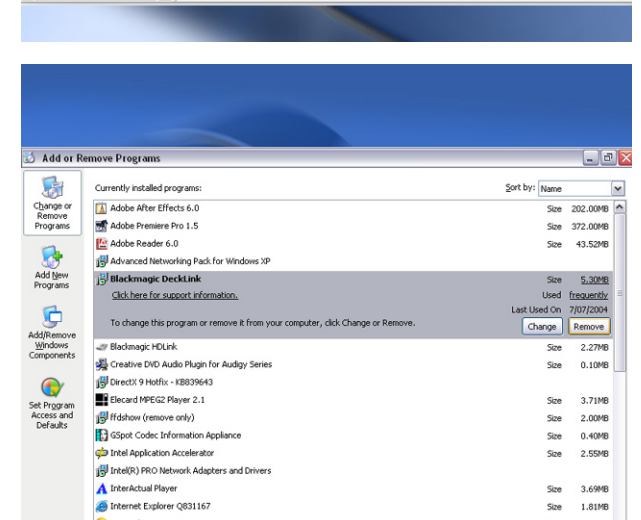
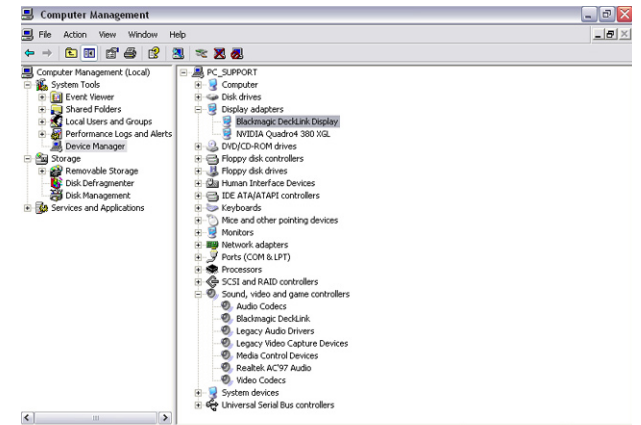



Windows XP™

Getting Connected: Display Settings

1. After completing the software and hardware installation, connect your DeckLink card to an external device such as a broadcast monitor, tape deck or Blackmagic HDLink. Connection diagrams, for the DeckLink family of cards, can be found towards the end of this manual from page 21 onwards.
2. Go to **Control Panels -> Displays** and click on the Settings tab. Select the DeckLink display which is shown as “Display 2” in the accompanying screenshot of the “Display Properties.” In this diagram, the Screen Resolution is set to 720 x 486 which is the setting for NTSC. If you need to switch to PAL or a HDTV resolution, click on the “Advanced” button.
3. When the new window opens, click on the Adapter tab and it should list “Blackmagic DeckLink Display” for the Adapter Type. Click the “List All Modes” button shown in the Default Monitor screenshot.
4. The “List All Modes” window will show you all of the modes supported by your model of DeckLink card. The standard definition DeckLink cards will list two modes, NTSC (720 x 486, 29 Hz) and PAL (720 x 576, 25 Hz), as shown in the screenshot. The high definition DeckLink cards will list many more modes.

Select the desired mode and then click OK. In the Default Monitor window, click “Apply.”

Note: DeckLink HD cards can display only 720x486 or 720x576 in desktop mode.

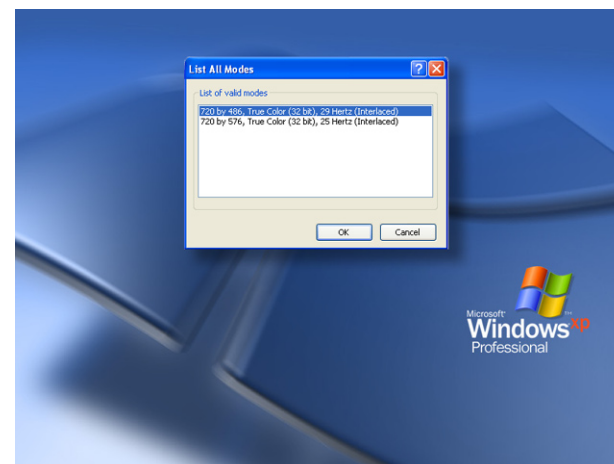
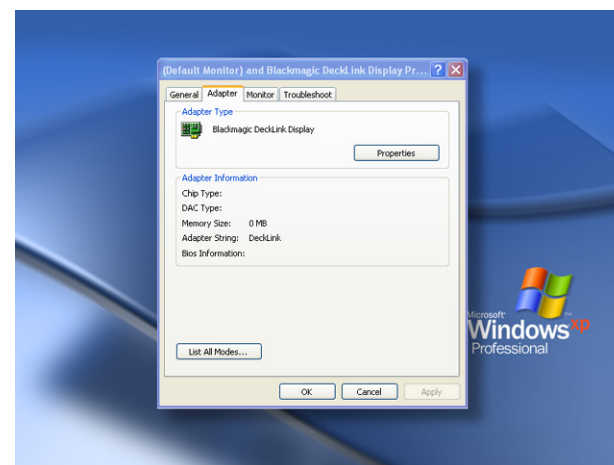
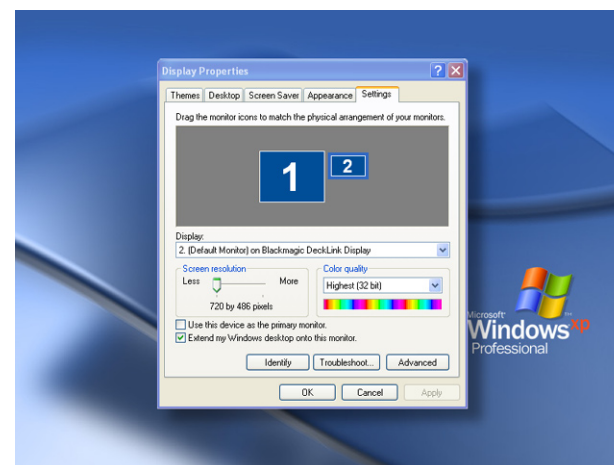



Windows XP™

5. A message will appear requesting that you confirm this change to the resolution. If your broadcast monitor appears to show the correct resolution, click the “Yes” button. Then click the “OK” button in both the Default Monitor window and finally in the Display Properties window.

Note: There is an easier method for switching between HDTV resolutions. Just use the Screen Resolution slider in the Display Properties windows to move between resolutions. Unfortunately the Screen Resolution slider cannot be used to switch to NTSC or PAL as Windows XP hides resolutions below a certain size. That is why the “List All Modes” window must be used to switch to standard definition resolutions.

6. The SDI and analog outputs are always active on DeckLink cards. If you need to switch the analog connections between composite and component, use the DeckLink control panel located in “Control Panels.” You can adjust your analog settings in the video tab of the DeckLink control panel.

Note: When using the DeckLink HD Pro video output in RGB 4:4:4 Dual Link mode, the signal from the analog component outputs will be RGB, so switch your broadcast monitor to RGB. You can still playback 8 and 10 bit YUV files, as this setting only effects the video output setting. DeckLink HD Pro will translate these files to RGB on playback in real time.

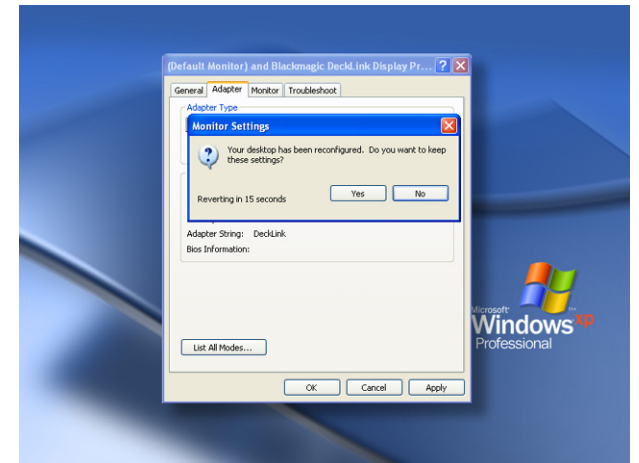



Windows XP™

Analog Video Input Processor Amplifier

We now include a Proc Amp tab in the DeckLink control panel.

Proc Amp can be used to adjust gain level controls for any cards with analog input, i.e. the DeckLink SP and DeckLink Extreme. We have decided to add this control due to variations in video output from analog tape decks.

This is also a reason why SDI is preferable to analog video, as it does not suffer from the potential gain variance issues which can be seen with analog components.

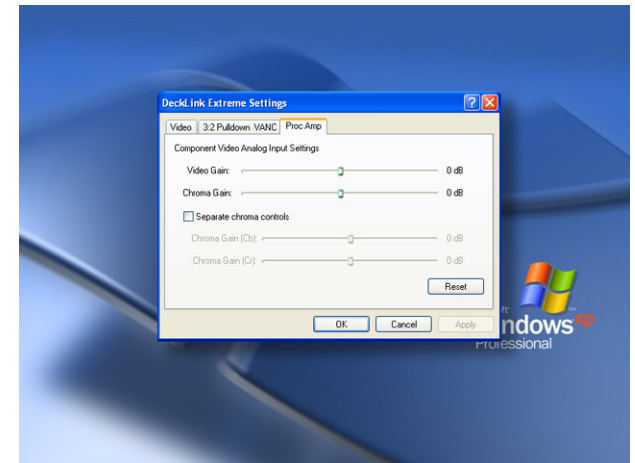

Preserving Blanking Data or VANC

To preserve VANC data when capturing, this can be enabled in the DeckLink control panel. Now you can use up to 3 video lines at the top of a captured QuickTime™ (Mac & Windows) or AVI (Windows only) movie file to store any 3 lines from vertical blanking. This allows 3 line timecode, VITC, vertical interval test signals, subtitle info or any other VANC data to be preserved between capture and playback. Software applications can also access these lines if required.

This uses standard QuickTime™ and AVI files, so applications such as After Effects® and Premiere Pro® will be compatible. This works on all standard or high definition DeckLink cards. You can select if you want 1, 2 or 3 lines to be used.

Although an extra metadata track to the QuickTime™/AVI file would be desirable, it would not be compatible with some video applications. We also thought about making the movie file 3 lines larger in the vertical resolution. So for example, 1080 would become 1083. However these files would be incompatible with normal files so it is not a good solution. So we thought that most people don't miss a line or two from the top of the image and it would be beneficial to include this feature and use a line or 2 or 3 for that blanking data storage.

The great advantage is we don't need to know about the data structure of the VANC data, as we just capture the lines. So if there is some special data that you want to use, that's no problem, as we just capture the lines intact, put them in the top lines of the movie file. We then put the lines back into the vertical blanking when playing back the files.

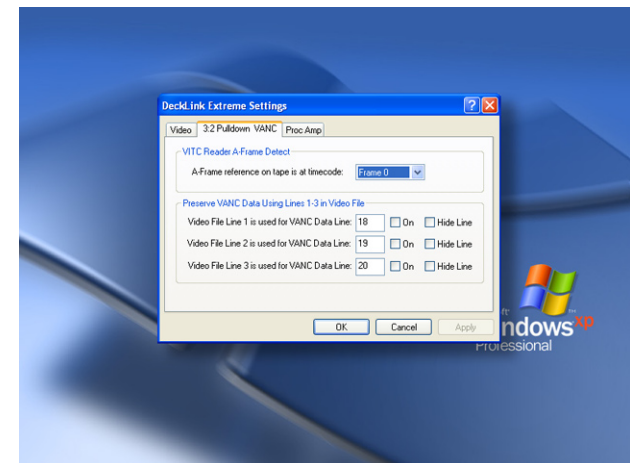



Windows XP™

Because these lines can be passed to the application, a developer could write software to read the VANC data and use it for various purposes, e.g. 3-line timecode and audio chasing, or other uses. This feature has unlimited uses!

You can use this feature with software, such as Deck Emulator software, to create a disk recorder that captures and preserves on playback 3-line timecode in telecine suites etc.

How the VANC Feature Works?

This feature allows you to preserve lines of VANC in the vertical blanking and store them into lines 1 to 3 of the video file. These lines are then inserted back into the video blanking when the file is played back.

You can select to hide these lines from the application so they don't look ugly, or to let them be passed to the application if you are running software that interprets this data.

An example of VANC data is 3-line timecode, which uses lines 18, 19, and 20 in NTSC or lines 19, 20 and 21 in PAL. 3-line timecode, as used in AATON™ equipped telecine suites, feature audio timecode and keycode information along with the normal timecode numbers.

Genlock

Genlock, also known as black burst or house sync is used to lock different pieces of equipment to the same timing throughout a facility. When two or more video devices are connected to the same sync signal, their video signals can be switched without jumping or rolling. This is critical when more than two devices are connected at the same time.

DeckLink and DeckLink HD cards are designed for direct connection to video decks, and as such, do not have genlock connections. When using these or any other Decklink cards directly with a deck, the deck can be synced to the video signal coming from the Decklink card. The Blackmagic Decklink System Preferences can set to provide a stable black signal to the deck during capture operations, as found in Control Panels in Windows™.

All other SD DeckLink cards can be connected to standard bi level sync for genlock. This standard composite video signal needs to be stable, which is why we recommend a specific signal generator like a blackburst generator. All other HD DeckLink cards need to be connected to tri level sync when in HD mode, to correctly lock. If these cards are running in SD mode then a standard bi level sync can be used.



Windows XP™

Blackmagic Deck Control

Blackmagic Deck Control is a basic utility used for capture from, and recording to your tape deck. It is controlled via RS-422 and uses the Sony™ RS-422 protocol.

It is designed to be used in conjunction with applications such as Adobe After Effects® and Discreet Combustion™, which do not include their own deck control capabilities.

Pixel formats supported by Blackmagic Deck Control are:

- Blackmagic QuickTime™ R210 (10 bit uncompressed 4:4:4 RGB)
- Blackmagic QuickTime™ v210 (10 bit uncompressed)
- Blackmagic QuickTime™ (8 bit uncompressed)
- Blackmagic QuickTime™ PhotoJPEG (compressed)

This utility can capture or playback one video clip at a time. The application windows, of which there are two, are used for viewing clips and deck control. The left window is the clip playback window and the right is the capture/deck window.

NOTE: Deck Control does not currently support AVI files, so you should not use it for capture when working with applications such as Adobe Premiere Pro™

Setting Up

1. Double click the Deck Control icon on your desktop to open the application.
2. Open edit -> preferences. Select one of the Easy Setups from the drop down menu.
3. Select your disk array as the capture location.
4. Click "OK."
5. Select File-> open, and choose the video file you wish to playback. The file will appear in the playback window. Click the "play" triangle below the clip. You can also scrub the clip just like the QuickTime™ player.

Note: Make sure the files you wish to play back are TV-formatted QuickTime™ files. If they're not QuickTime™ files, you'll not see your clip on the DeckLink output. Deck Control will not playback AVI files but this is planned for a future update.

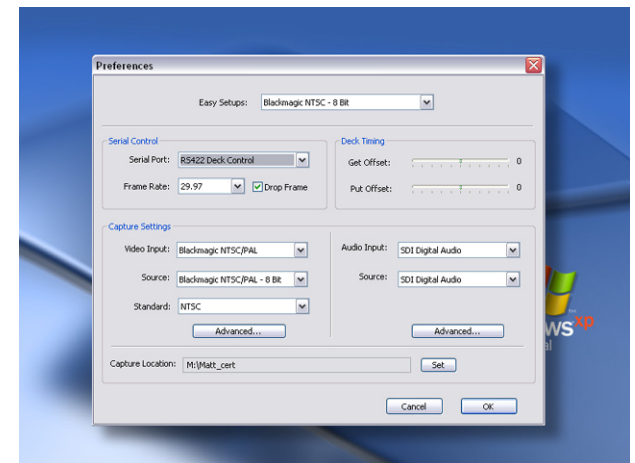
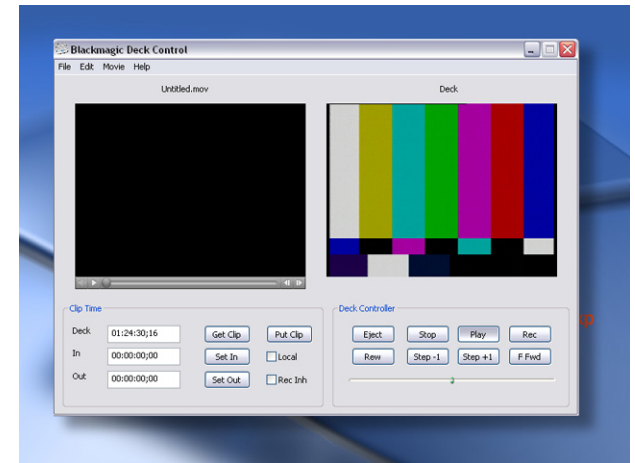



Windows XP™

Deck Control features

- Loop playback**
- Loop back and forth**
- Grab frame** (to Photoshop™ file)
- Copy and paste** (just like QuickTime™ player)

Inserting to Tape

1. Open the clip that you require to print to tape.
2. Enter the timecode of the desired in-point.
3. Click “Put clip.”

Capturing Clips

There are two ways to capture clips.

1. **Capture now** – captures video and audio instantly.
Short cut: Control K.
2. **Get clip** – captures frame accurate timecode, video, audio to “in” and “out-points” set by the user. [Timecode will only be available if RS-422 is connected]

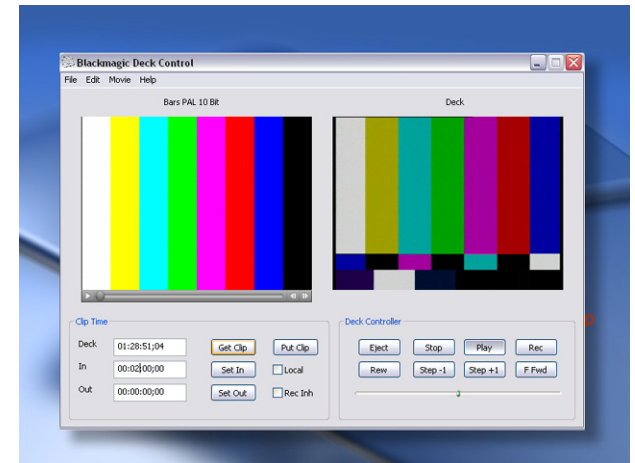



Windows XP™

Blackmagic LiveKey

[Standard Definition Only]

Video and Key output support is included with the **DeckLink Pro** capture card.

You can output the key and fill channel using DeckLink Pro with a down-stream keyer/mixer for use in 'live events' and broadcast graphics.

DeckLink (i and ii), **DeckLink Pro**, **DeckLink SP** and **DeckLink Extreme** cards also feature internal keyers. This means you can key inside the card and dub video through the card with keyed graphics over the top. Blackmagic LiveKey also features 'fade up and down' of the graphic automatically.

Blackmagic LiveKey lets you enable these modes and when you quit this application, the card will return to a normal video operation. Because you can dub from your broadcast deck to VHS via the DeckLink Pro, DeckLink SP and DeckLink Extreme cards, you can finish a master, and then using Blackmagic LiveKey add a company logo or bug to your show reel dubs.

As Blackmagic LiveKey is used in environments where the keyed picture is broadcast to air or for live events; once launched, Blackmagic LiveKey will dominate the output of the Decklink card. This means that even if Blackmagic LiveKey is in the background and another application is in use, the video output will be stable and reliable.

NOTE: When Blackmagic LiveKey is in use, you won't be able to open any other software application that needs to control the Decklink card, such as your NLE or compositing software.



Windows XP™

Hardware Down-Conversion with DeckLink HD Pro

Simply go to control panels -> decklink and choose the down conversion you require. It can be switched between 4:3 letterbox or 16:9 anamorphic.

Link A output will be the SD and Link B output will always be HD. The outputs are simultaneous and the downconversion is broadcast quality.

Note: For desktop down-conversion make sure that the desktop is set to either 29 hertz or 25 hertz. Down conversion is not currently available for 23.98 or 24PsF

Note: Down-conversion is not available if in Dual Link 4:4:4 mode.

Switching to 4:4:4 mode with DeckLink HD Pro

Go to control panels ->decklink select the dual link RGB 4:4:4 checkbox Your card is now in 4:4:4 mode and can be used with programs such as Premiere Pro and After Effects for full 10 bit HD 4:4:4 editing and effects work.

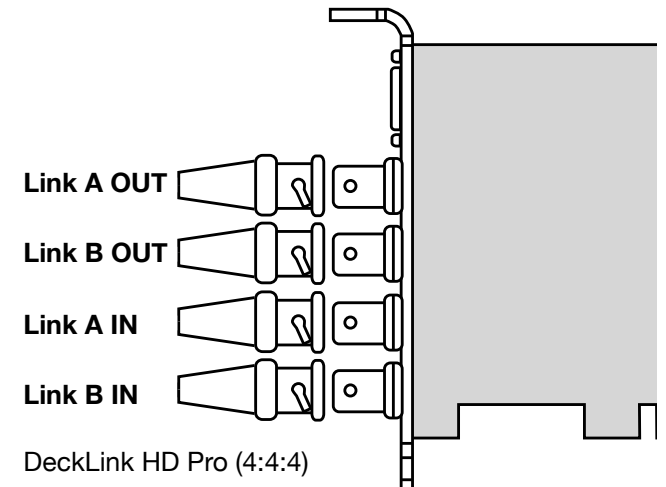



Windows XP™

Adobe After Effects®

Minimal configuration is required for Adobe After Effects®.

Simply, open the application and select the television standard frame size and frame rate you wish to work with.

How to use your DeckLink Card as a Frame Buffer

To allow your Adobe After Effects® composition to be displayed in real-time from your DeckLink card, go to **edit->preferences->video preview**. Select Blackmagic RGB and the appropriate video standard. Now you can view your Adobe After Effects® compositions in YUV colorspace on your broadcast monitor as well as your desktop. No more nasty surprises when you go to air or tape - what you see is what you get!

Rendering

When you have completed your composition, you will need to render to a pixel format supported by Blackmagic DeckLink.

Below is a list of supported codecs:

- Blackmagic QuickTime™ R210 (10 bit uncompressed 4:4:4 RGB)
- Blackmagic QuickTime™ V210 (10 bit uncompressed)
- Blackmagic QuickTime™ (8 bit uncompressed)
- Blackmagic QuickTime™ PhotoJPEG (compressed)
- Video for Windows™ (8 bit uncompressed AVI)
- Video for Windows™ (10 bit uncompressed AVI)
- Video for Windows™ R210 (10 bit uncompressed 4:4:4 RGB AVI)

For all HD standards, select upper field first.

For NTSC 720 x 486, select lower field first.

For PAL 720 x 576, select upper field first.

Supported file formats in Premiere Pro™

- RGBA (RGB + Alpha) Video for Windows (None)
- Blackmagic QuickTime™ 8 bit and 10 bit uncompressed
- Blackmagic 8 bit and 10 bit uncompressed AVI
- Blackmagic QuickTime™ R210 (10 bit uncompressed 4:4:4 RGB)
- Video for Windows™ R210 (10 bit uncompressed 4:4:4 RGB AVI)
- Targa Sequential Sequences
- Bitmap Sequential Sequences

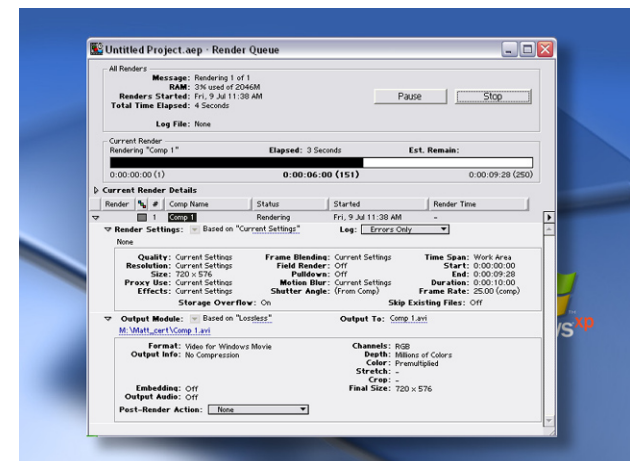
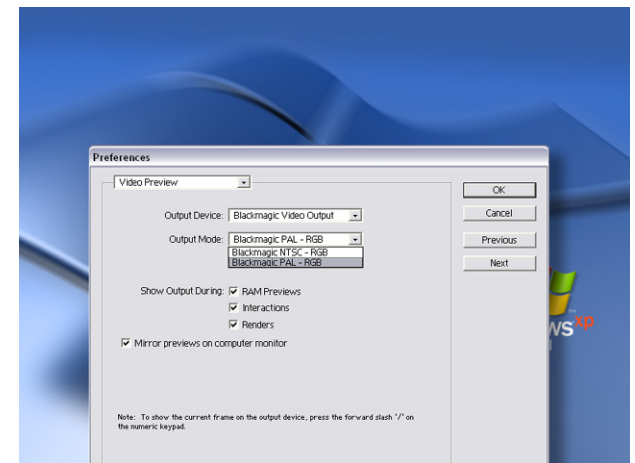
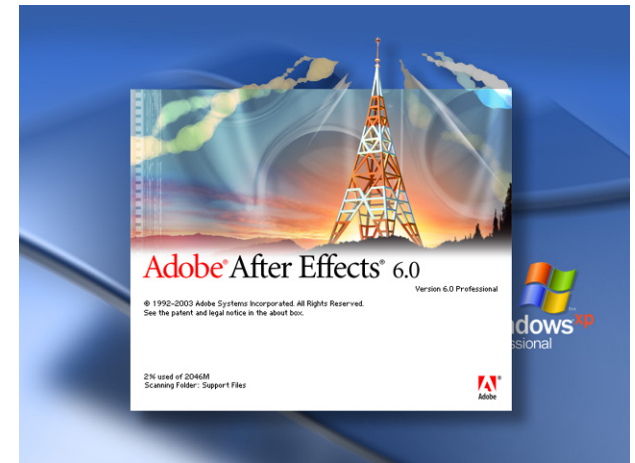



Windows XP™

Adobe Premiere Pro®

Adobe Premiere Pro® is powerful real-time video and audio non-linear editing application. The Blackmagic DeckLink installer will add easy set-ups for Premiere Pro®.

Setting Up

Launch Premiere Pro®.

1. Open a New Project.
2. Select the appropriate Blackmagic preset for your project, e.g. NTSC or PAL.
3. Type the name of your project.
4. Select your disk array as the location for your media and click "OK."

Playback

As a quick test to make sure everything is connected correctly, use the Blackmagic test media (bars and tone) which can be found on the installer CD. Copy a test clip, which matches the format of your project, to your disk array e.g. NTSC 8 bit. Import this clip into your Premiere Pro® project and drop it into the timeline. You should now see the image on both your computer desktop and your DeckLink output. If you can't see any video on your DeckLink output, check the connections again and ensure you have the correct output settings configured in both the DeckLink and Displays "control panels."

Note: SDI and analog outputs are always active.

Capture

To capture, **choose file -> capture.**

Short cut: F5.

To immediately capture, click the red record button [G].

If you wish to log the clip, enter the desired "in" and "out-points" using either the "in" and "out" buttons or manually, by typing in the timecode and clicking "log".

The empty clip will now appear in the bin window. Repeat this until you have logged all of the clips you wish to capture in a batch.

Batch Capture

Select the clips you wish to capture by marquee or shift/click. **Choose File -> Batch capture.** To set handles on the clips go to the batch capture window and type the number of additional frames you require at the top and tail of each clip.

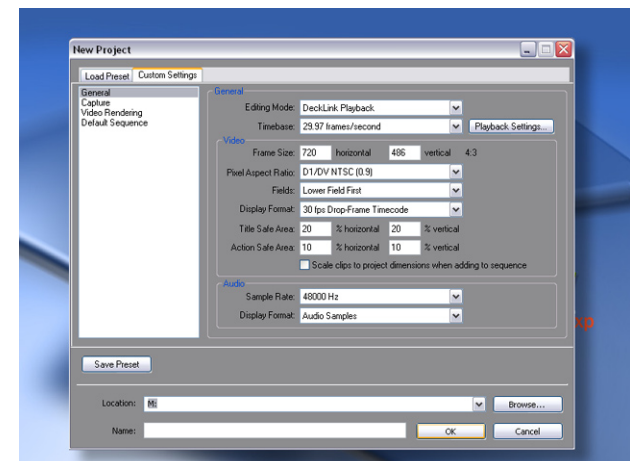
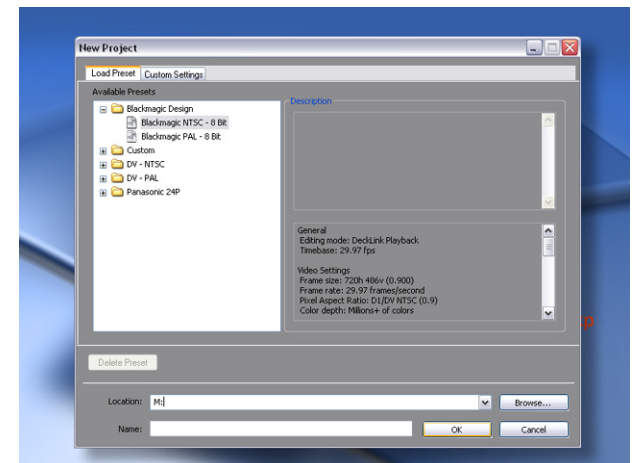



Windows XP™

Adobe Premiere Pro®

Audio in Premiere Pro.

DeckLink cards now support ASIO. This means in Premiere Pro that the card is seen as an audio device. When you first start your Premiere Pro project, make sure you select the audio device you wish to use – either DeckLink audio or a selected sound card. This can be done through Edit->preferences->audio hardware. You can also select the mix of the multi-channel audio from this menu.

Export to tape

To export to tape, select the sequence you require ->file->export->export to tape.

Insert editing requires an unbroken timecode over the full length of the program you're laying to tape. This is referred to as 'blacking the tape'.

In **assemble mode** the tape needs only to be 'blacked' until a point just beyond the start time of the program. As **assemble editing** erases the tape ahead of the record heads, it should not be used where other programs already exist on the tape after the out point of your edit.

Premiere Pro™ does not work like a deck. When editing to tape, the software waits at the first frame of your program for the deck to drop into record at the predetermined timecode. At that exact moment, the program begins to play and the edit is completed. Should you find that either the first frame of your program is repeated or lost during the edit to tape procedure you will need to adjust the playback offset to bring the deck and your computer into sync. You should only need to do this once with any combination of deck and computer - and the setting will stay correct thereafter.

Now, simply enter the desired in point and offsets if required, and click OK.



Windows XP™

Trouble Shooting

Q: There is no output from my card when in desktop mode.

A: Right click the **desktop -> properties -> settings tab**. Then left click the DeckLink monitor within the “Display Properties” menu and select “extend my windows desktop to this monitor”. Click “apply,” then “OK.” You should now see your extended desktop on your broadcast monitor.

Q: I can't get machine control of my tape deck.

A: Make sure that the deck you are using supports and is connected via the Sony RS-422 serial protocol. DeckLink does not support older RS-232 serial devices. If using a Panasonic deck, you may need to use the deck's USER Menu to change the “ID SEL” to “other”, to make it compatible with the Sony RS-422 deck control protocol. “ID SEL” is usually USER Menu item number 202.

Q: Can I monitor audio from my PC speakers?

A: Yes you can, however we do not recommend it. This is because the PC system clock and the DeckLink's clock are different. If you monitor audio through your PC speakers, audio sync for monitoring cannot be guaranteed. We recommend using the SPDIF output connectors from the DeckLink PCI card.



Windows XP™

If things go wrong

There are three steps to getting help.

Step 1. Check out the Blackmagic Design web site www.blackmagic-design.com and “click on the support page” for the latest support information.

Step 2. Call your dealer.

Your dealer will have the latest technical updates from Blackmagic Design, and should be able to give you immediate assistance. We also recommend you check out the support options your dealer offers as they can arrange various support plans based on your workflow requirements.

Step 4. The next option is to email us at pcsupport@blackmagic-design.com with your questions.

Note: Please provide us with as much information as possible regarding your technical problem and system specifications so that we may try to reproduce your problem quickly.

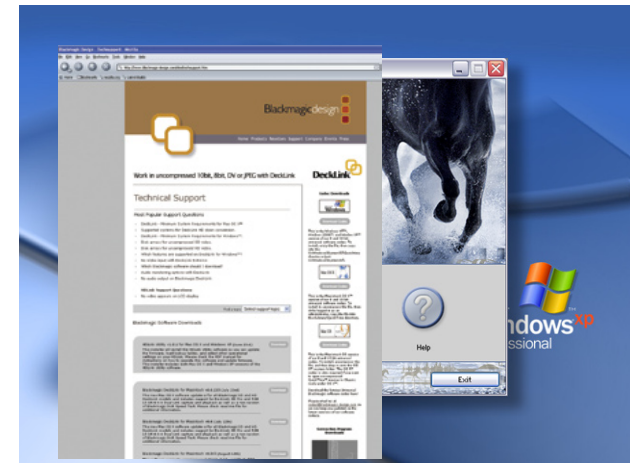



Windows XP™

Connection Diagrams

DeckLink™

SD-SDI 4:2:2 video and audio, capture and playback card

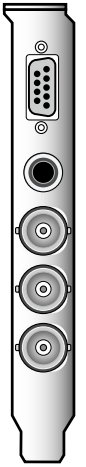

Deck Control
RS-422

SPDIF/AES
Output

SD-SDI 4:2:2
Monitoring Output

SD-SDI 4:2:2
Output (to deck)

SD-SDI 4:2:2
Input (from deck)

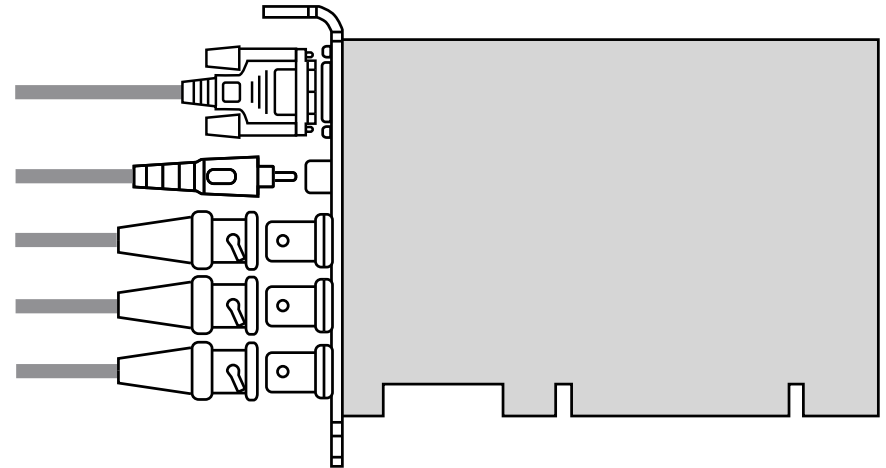

This DeckLink model does not have genlock, so you need to connect your deck to the Deck SDI Output, which has stable output to sync the deck. Set the deck to input or auto reference. Be sure to set the “Black Video Output to Deck in Capture” option to “On Digital SDI Outputs” in the DeckLink control panel, when using this feature.

Connection Diagrams



Windows XP™

DeckLink Pro™

SD-SDI 4:2:2 video and audio capture and playback card with analog monitoring

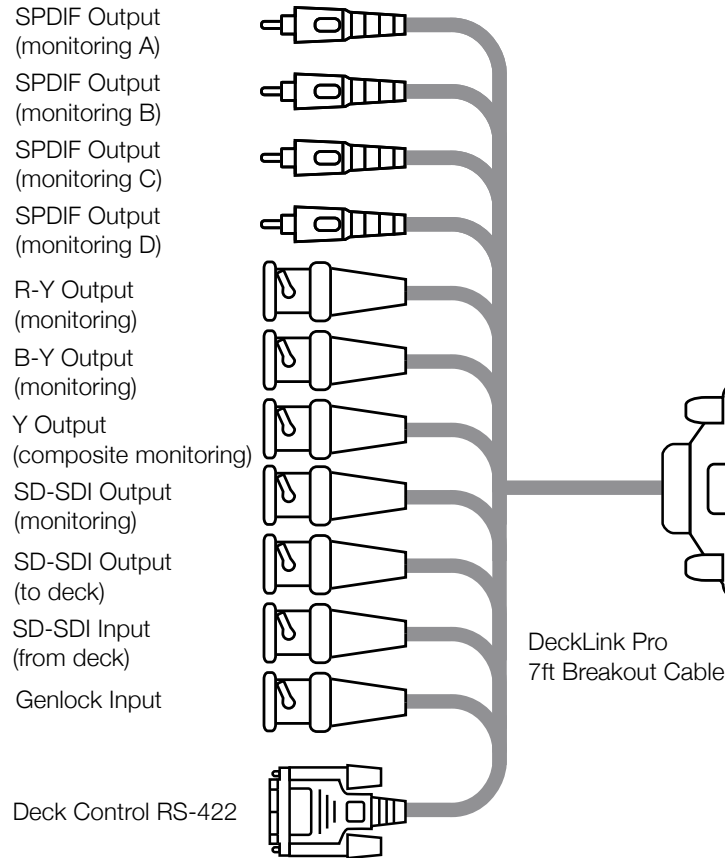
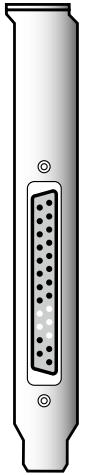

When you don't have genlock, you can output stable black so DeckLink Pro locks the deck. This output is always stable and allows the deck to be set to input reference or auto reference. Be sure to set the "Black Video Output to Deck in Capture" option to "On Digital SDI Outputs" in the DeckLink control panel, when using this feature.

Connection Diagrams



Windows XP™

DeckLink SP™

Analog video and audio capture and playback card with SD-SDI 4:2:2 monitoring

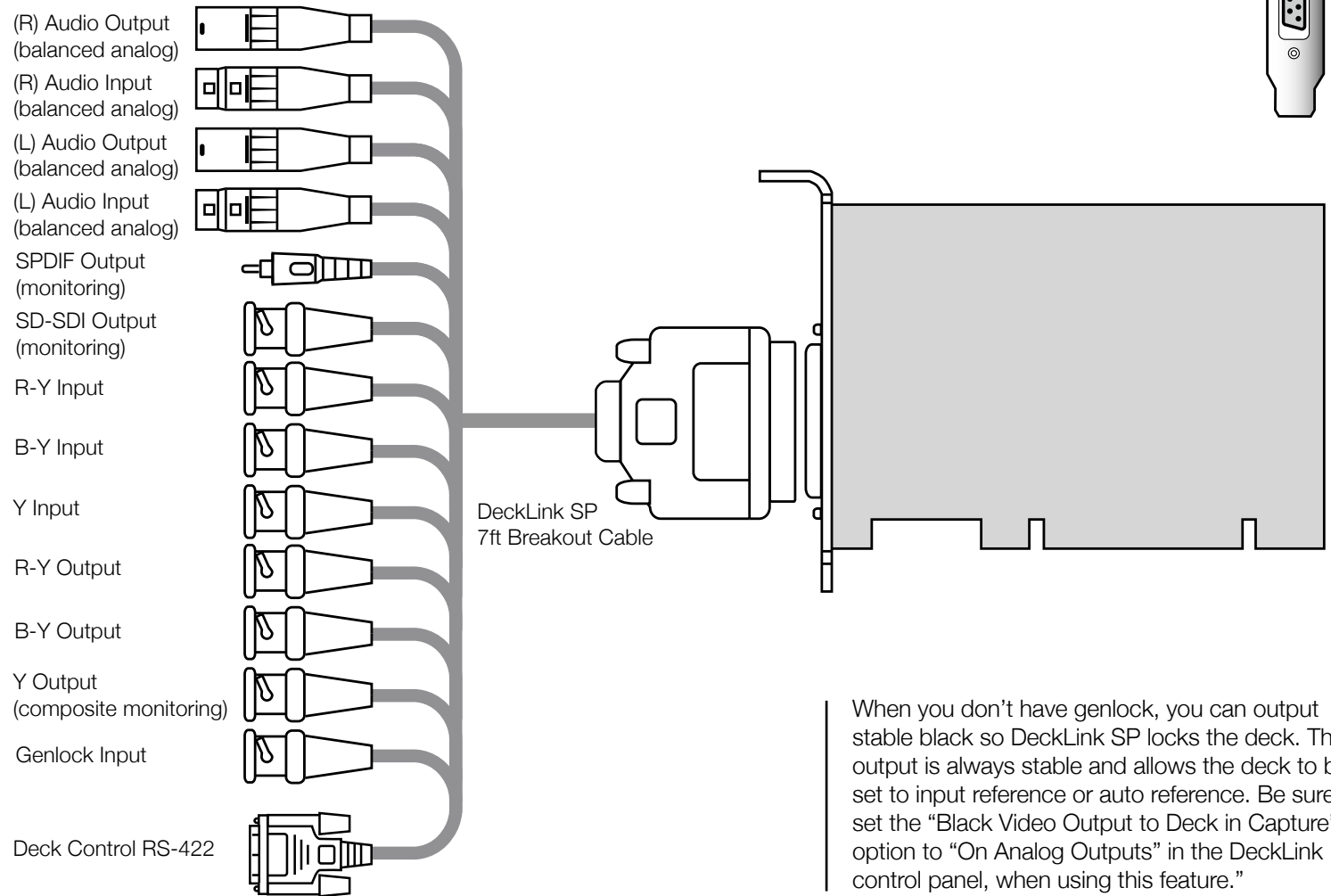
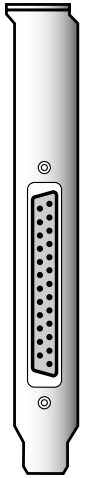

When you don't have genlock, you can output stable black so DeckLink SP locks the deck. This output is always stable and allows the deck to be set to input reference or auto reference. Be sure to set the "Black Video Output to Deck in Capture" option to "On Analog Outputs" in the DeckLink control panel, when using this feature."

Connection Diagrams



Windows XP™

DeckLink Extreme™

SD-SDI 4:2:2 and analog video, audio capture and playback card

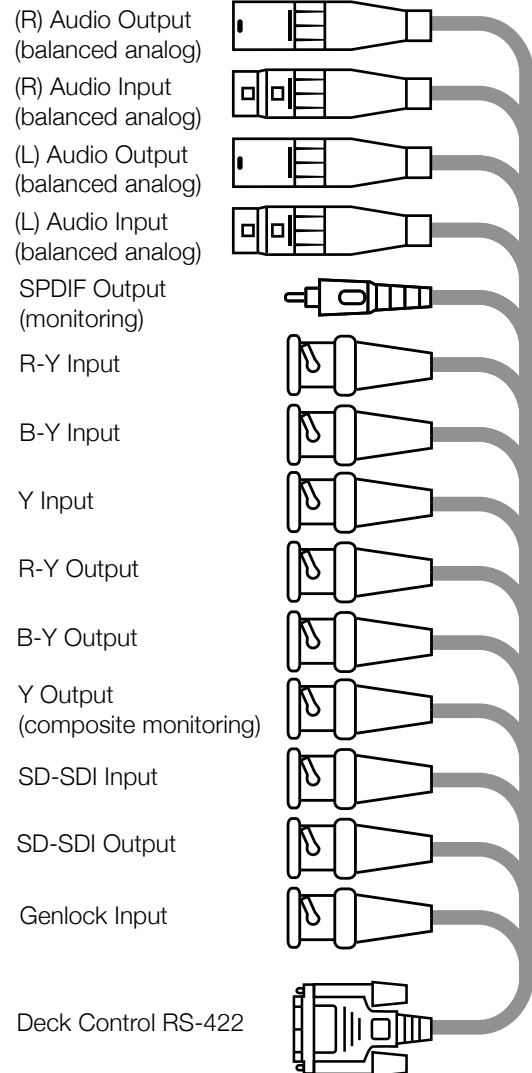
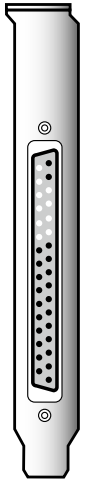

DeckLink Extreme
7ft Breakout Cable

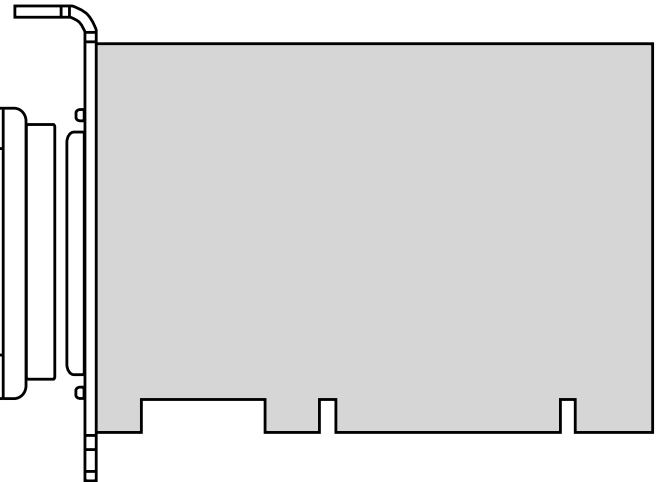

When you don't have genlock, you can output stable black so DeckLink Extreme locks the deck. This output is always stable and allows the deck to be set to input reference or auto reference. If you are using a digital deck, be sure to set the "Black Video Output to Deck in Capture" option to "On Digital SDI Outputs" in the DeckLink control panel, when using this feature. If you are using an analog deck, be sure to set the "Black Video Output to Deck in Capture" option to "On Analog Outputs".

Connection Diagrams

DeckLink Extreme™ cable



Windows XP™

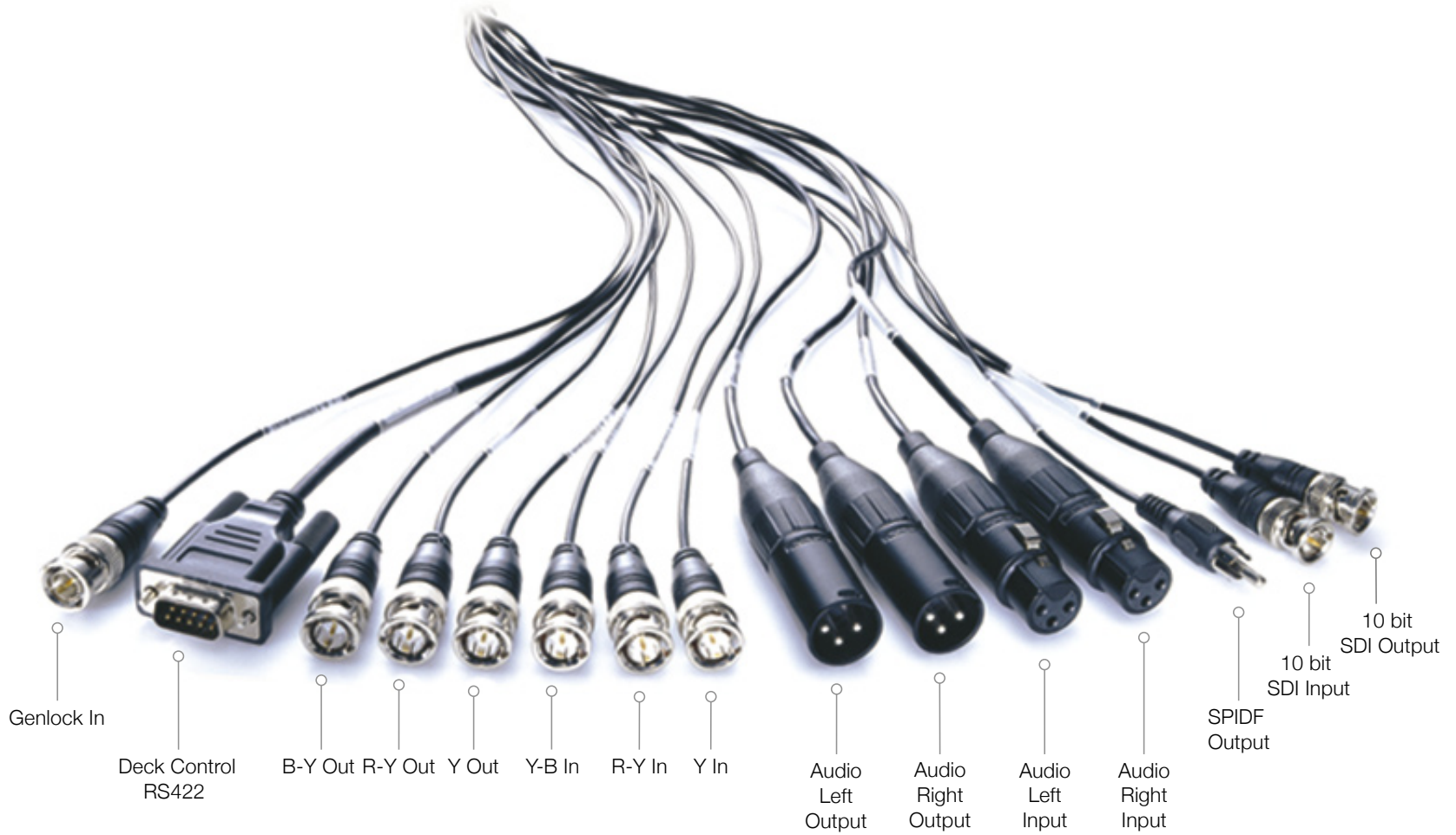



Windows XP™

Connection Diagrams

DeckLink HD™

HD/SD-SDI 4:2:2 video, audio capture and playback card

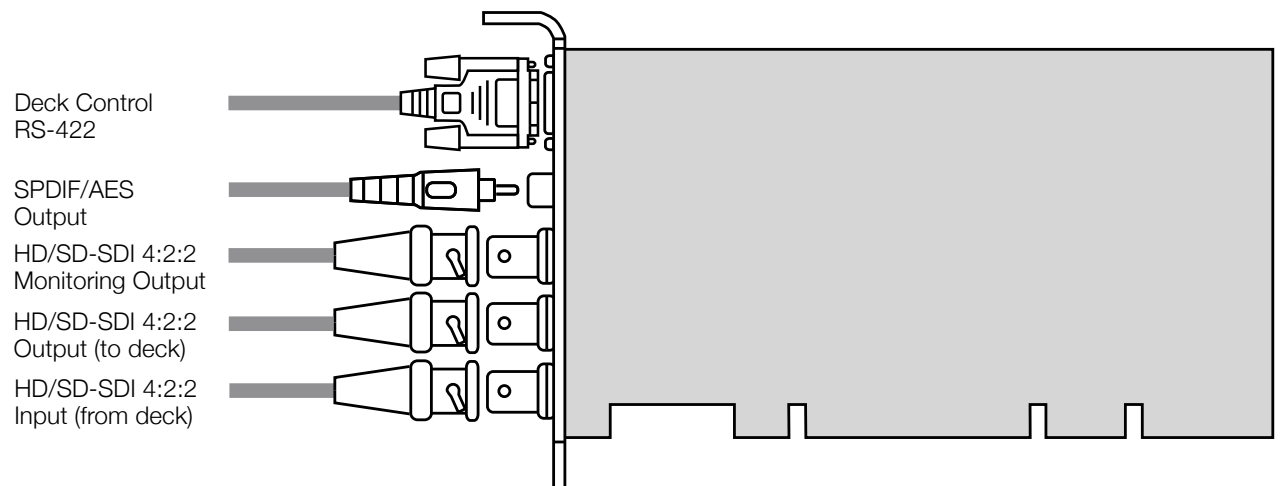
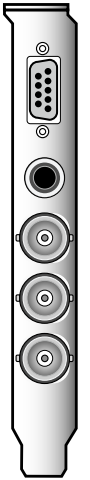

This DeckLink HD model does not have genlock, so you need to connect your deck to the Deck SDI Output which has stable output to sync the deck. Set the deck to input or auto reference. Be sure to set the “Black Video Output to Deck in Capture” option to “On Digital SDI Outputs” in the DeckLink control panel, when using this feature.”

Connection Diagrams



Windows XP™

DeckLink HD Pro™

HD/SD-SDI 4:4:4/4:2:2 video, audio capture and playback card with analog monitoring
(Dual Link Mode 4:4:4)

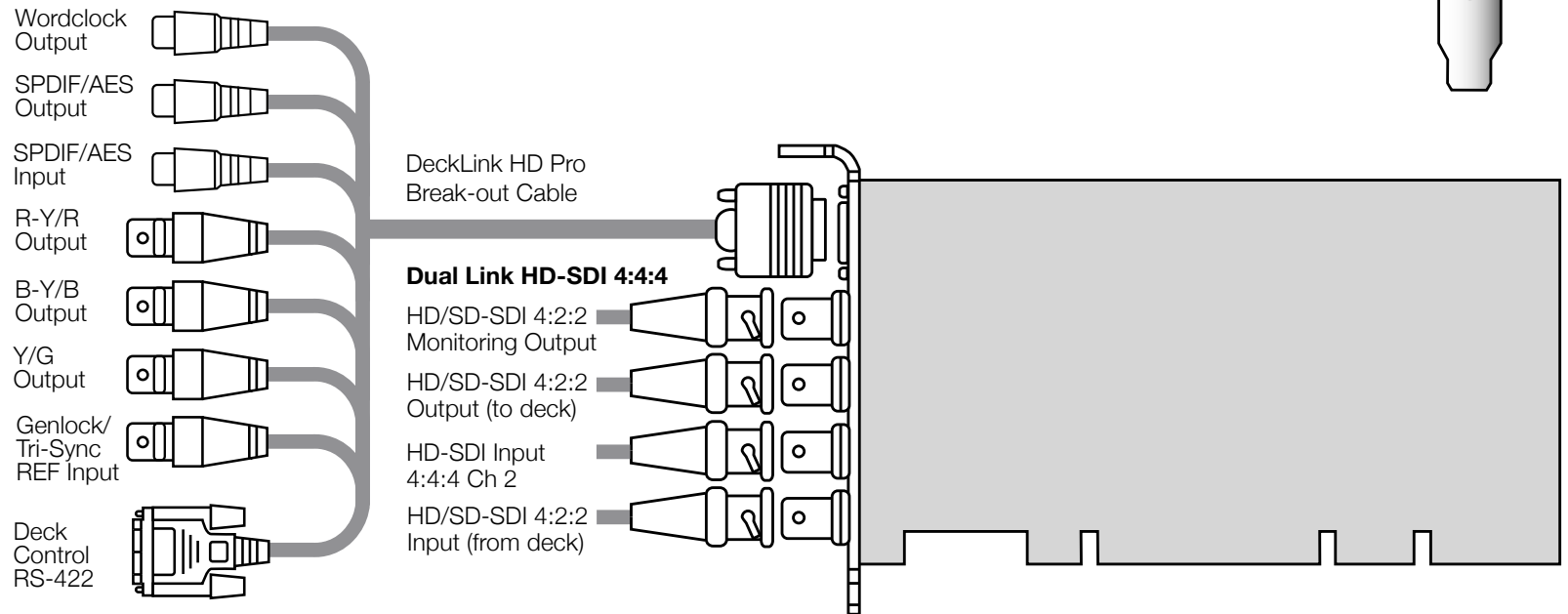
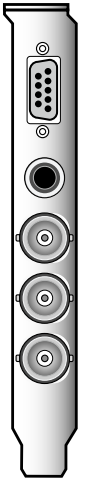

When you don't have genlock, you can output stable black, so DeckLink HD Pro locks the deck. This output is always stable and allows the deck to be set to input reference or auto reference. Be sure to set the "Black Video Output to Deck in Capture" option to "On Digital SDI Outputs" in the DeckLink control panel, when using this feature.

Connection Diagrams



Windows XP™

DeckLink HD Pro™

HD/SD-SDI 4:4:4/4:2:2 video, audio capture and playback card with analog monitoring
(Single Link Mode 4:2:2)

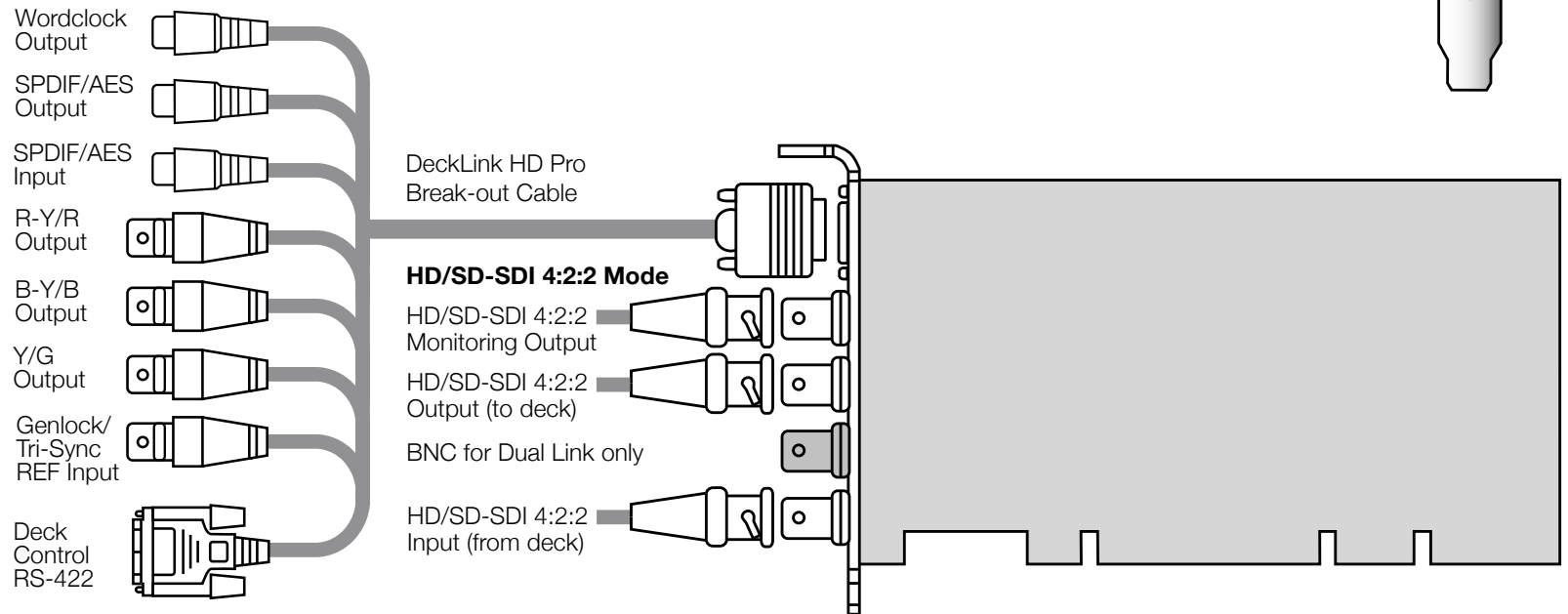
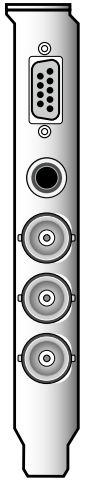

When you don't have genlock, you can output stable black so DeckLink HD Pro locks the deck. This output is always stable and allows the deck to be set to input reference or auto reference. Be sure to set the "Black Video Output to Deck in Capture" option to "On Digital SDI Outputs" in the DeckLink control panel, when using this feature.

Connection Diagrams

DeckLink HD Pro™ (Single Link card)

HD/SD-SDI 4:2:2 video, audio capture and playback card with analog monitoring



Windows XP™

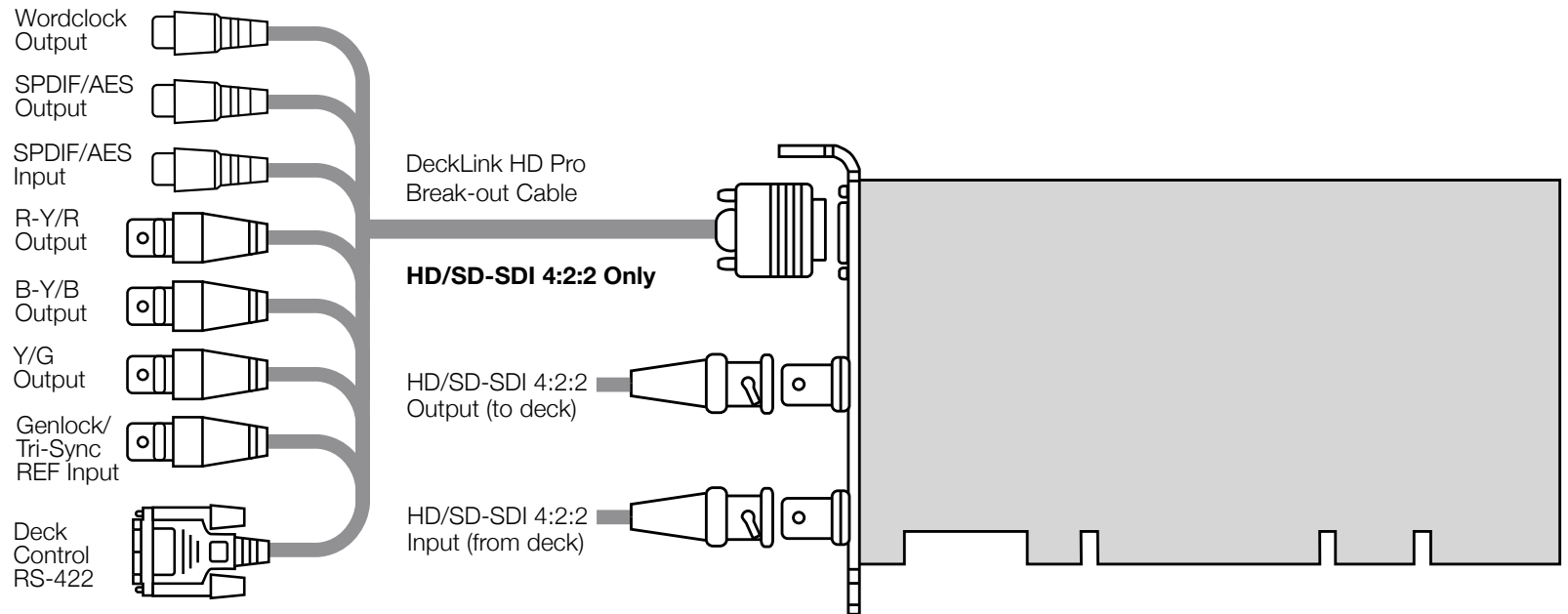

When you don't have genlock, you can output stable black so DeckLink HD Pro locks the deck. This output is always stable and allows the deck to be set to input reference or auto reference. Be sure to set the "Black Video Output to Deck in Capture" option to "On Digital SDI Outputs" in the DeckLink control panel, when using this feature.

Connection Diagrams

DeckLink HD Pro™ cable



Windows XP™

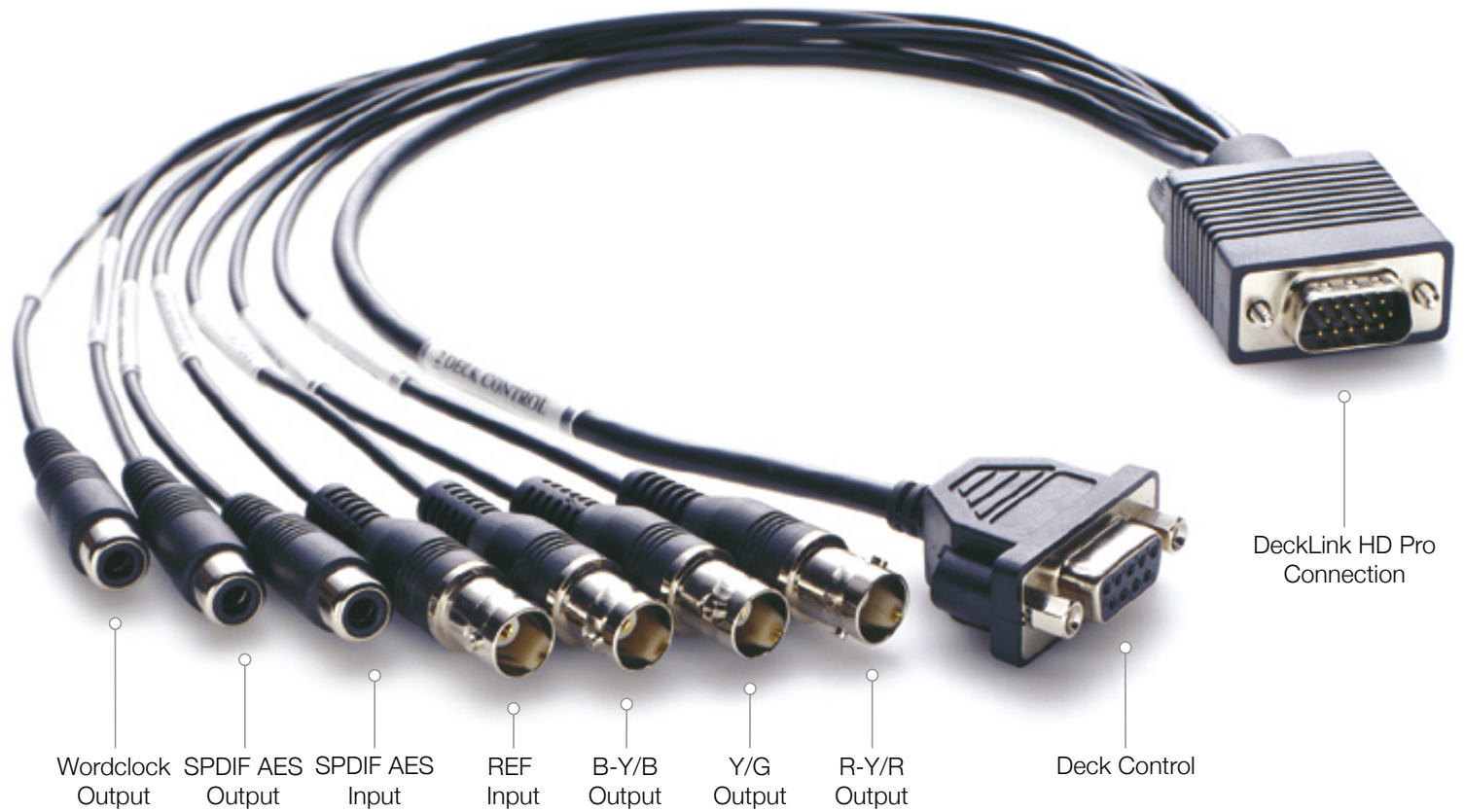



Windows XP™

Blackmagic Design Limited Warranty

Blackmagic Design warrants that this product will be free from defects in materials and workmanship for a period of 12 months from the date of purchase. If a product proves to be defective during this warranty period, Blackmagic Design, at its option, either will repair the defective product without charge for parts and labor, or will provide a replacement in exchange for the defective product.

In order to obtain service under this warranty, you the Customer, must notify Blackmagic Design of the defect before the expiration of the warranty period and make suitable arrangements for the performance of service. The Customer shall be responsible for packaging and shipping the defective product to a designated service center nominated by Blackmagic Design, with shipping charges pre paid. Customer shall be responsible for paying all shipping changes, insurance, duties, taxes, and any other charges for products returned to us for any reason.

This warranty shall not apply to any defect, failure or damage caused by improper use or improper or inadequate maintenance and care. Blackmagic Design shall not be obligated to furnish service under this warranty: a) to repair damage resulting from attempts by personal other than Blackmagic Design representatives to install, repair or service the product, b) to repair damage resulting from improper use or connection to incompatible equipment, c) to repair any damage or malfunction caused by the use of non Blackmagic Design parts or supplies, or d) to service a product that has been modified or integrated with other products when the effect of such a modification or integration increases the time or difficulty of servicing the product. THIS WARRANTY IS GIVEN BY BLACKMAGIC DESIGN IN LIEU OF ANY OTHER WARRANTIES, EXPRESS OR IMPLIED. BLACKMAGIC DESIGN AND ITS VENDORS DISCLAIM ANY IMPLIED WARRANTIES OF MERCHANTABILITY OR FITNESS FOR A PARTICULAR PURPOSE. BLACKMAGIC DESIGN'S RESPONSIBILITY TO REPAIR OR REPLACE DEFECTIVE PRODUCTS IS THE WHOLE AND EXCLUSIVE REMEDY PROVIDED TO THE CUSTOMER FOR ANY INDIRECT, SPECIAL, INCIDENTAL OR CONSEQUENTIAL DAMAGES IRRESPECTIVE OF WHETHER BLACKMAGIC DESIGN OR THE VENDOR HAS ADVANCE NOTICE OF THE POSSIBILITY OF SUCH DAMAGES. BLACKMAGIC DESIGN IS NOT LIABLE FOR ANY ILLEGAL USE OF EQUIPMENT BY CUSTOMER. BLACKMAGIC IS NOT LIABLE FOR ANY DAMAGES RESULTING FROM USE OF THIS PRODUCT. USER OPERATES THIS PRODUCT AT OWN RISK.

Copyright 2004 Blackmagic Design. All rights reserved. 'Blackmagic Design', 'DeckLink', 'HDLink', 'Declink Multibridge' 'Workgroup Videohub' and 'Leading the creative video revolution' are registered trademarks in the US and other countries. All other company and product names may be trade marks of their respective companies with which they are associated.