

PC TUTOR 2.0

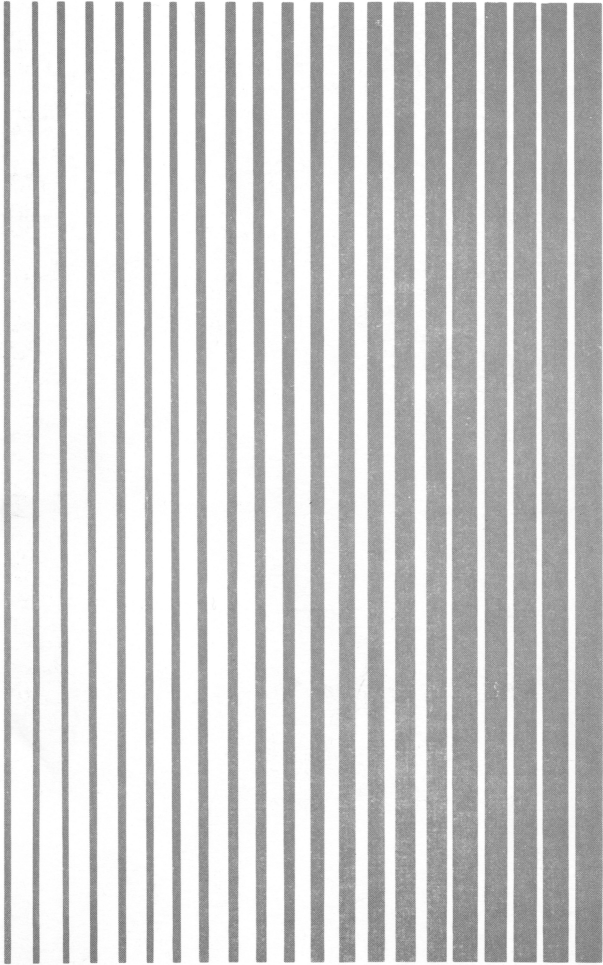

corona
data systems, inc.



Part No. 700711

PC TUTOR 2.0

Copyright 1985 by Daewoo Electronics Co., Ltd. All rights reserved.

Printed in Korea.

No part of this publication may be reproduced, stored in a retrieval system, or transmitted, in any form or by any means, electronic, mechanical, photocopying, recording, or otherwise, without the prior written permission of Corona Data Systems, Inc. The use of trademarks or other designations is for reference purposes only.

PC TUTOR is a trademark of Comprehensive Software. MS-DOS and Microsoft GW-BASIC are registered trademarks of Microsoft Corporation. IBM is a registered trademark of International Business Machines.

Part No. 700710

PC TUTOR 2.0

In this binder you will find a diskette labeled PC TUTOR 2.0. Using this diskette will provide you information about your computer, its operating system, and peripheral equipment, such as printers. To find out more, just follow the steps below.

Before turning on the power to the computer, do the following:

1. If you have a PC-400 (desktop), open the latch on the top floppy drive or the left floppy drive on a dual floppy system. If you have a PPC-400 (portable), open the latch on the front of the left hand floppy drive. If there is a cardboard head protector in the drive, pull it out and save it.
2. Remove the PC TUTOR diskette from its jacket with your right hand and thumb on the label.
3. For the desktop, insert the diskette into the drive with the label (your thumb) on top. For the portable, insert the diskette into the drive with your thumb facing left and toward the monitor.
4. Close the latch on the drive.

Now turn on the power switch located at the rear of the unit. Turn on the power switch to the

PC TUTOR 2.0

monitor also. (Portables do not have a monitor power switch.)

If the power is already on, press the Ctrl, Alt, and Del keys simultaneously.

PC TUTOR will automatically start and provide all further instructions on the monitor screen.

PC-400/PPC-400
USER'S GUIDE

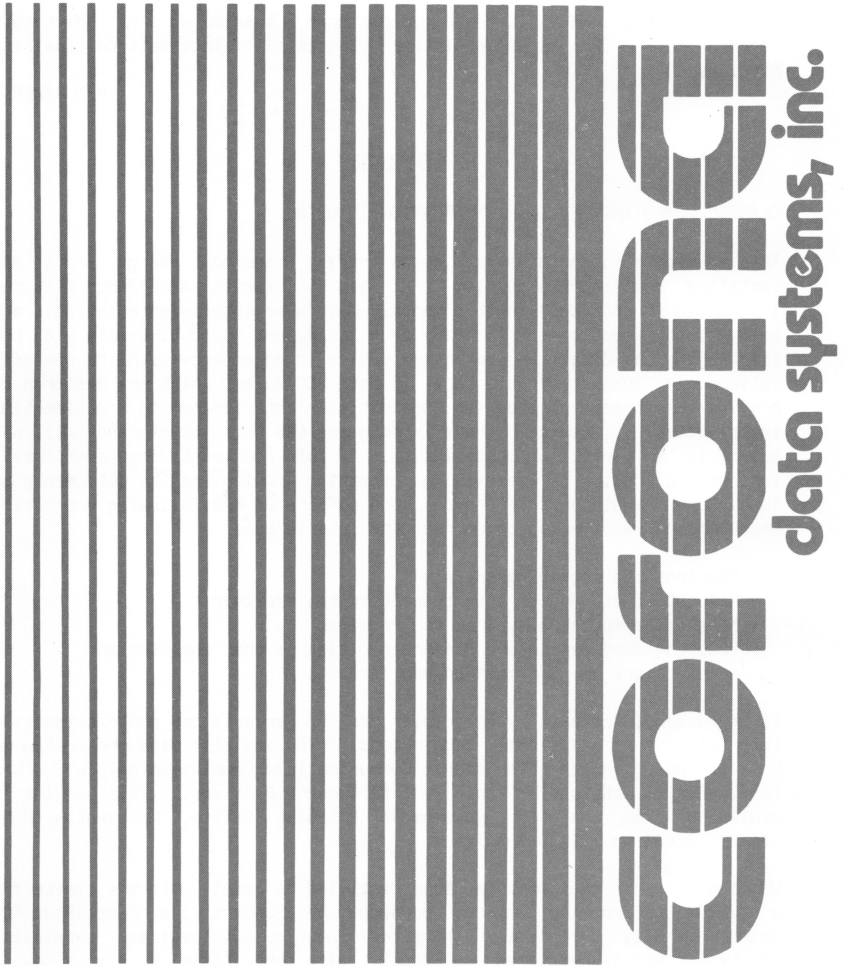

Printed in Korea.

No part of this publication may be reproduced, stored in a retrieval system, or transmitted, in any form or by any means, electronic, mechanical, photocopying, recording, or otherwise, without the prior written permission of Corona Data Systems, Inc. The use of trademarks or other designations is for reference purposes only.

MultiMate is a trademark of MultiMate International Corporation. MS-DOS and Microsoft GW-BASIC are registered trademarks of Microsoft Corporation. IBM is a registered trademark of International Business Machines.

P/N 700585

NOTICE

CLASS B COMPUTING DEVICE: INFORMATION TO USER

This equipment generates and uses radio frequency energy and if not installed and used properly, that is, in strict accordance with the instructions provided in this manual, may cause interference to radio and television reception. It has been tested and found to comply with the limits for a Class B computing device in accordance with the specifications in Subpart J of Part 15 of FCC Rules, which are designed to provide reasonable protection against such interference in a residential installation. However, there is no guarantee that interference will not occur in a particular installation. If this equipment does cause interference to radio or television reception (which can be determined by turning the equipment off and on), one or more of the following corrective measures are recommended to correct the interference:

- Reorient the receiving antenna
- Relocate the computer with respect to the receiver
- Move the computer away from the receiver
- Plug the computer into a different outlet so that computer and receiver are on different branch circuits

If necessary, consult your dealer or an experienced radio/television technician for additional suggestions. You may also find the following booklet prepared by the Federal Communications Commission helpful: "How to Identify and Resolve Radio-TV Interference Problems." This booklet is available from the U.S. Government Printing Office, Washington, D.C. 20402. Stock No. 004-000-00345-4.

Warning: This equipment has been certified to comply with the limits for a Class B computing device, pursuant to Subpart J of Part 15 of FCC Rules. Only peripherals (computer input/output devices, terminals, printers, etc.) certified to comply with the Class B limits may be attached to this computer. Operation with non-certified peripherals is likely to result in interference to radio and TV reception.

Connection of peripherals to this computer should be done with shielded cables. Use of a non-shielded cable is likely to result in interference to radio and TV reception.

PC-400 AND PPC-400 USER'S GUIDE

NOTICE

POWER VOLTAGE CONFIGURATION

Information about system voltage is provided on the next page of this addendum. It is the first thing you should know before connecting system components. The page is numbered 5-3a, and should be added after page 5-3 in this manual.

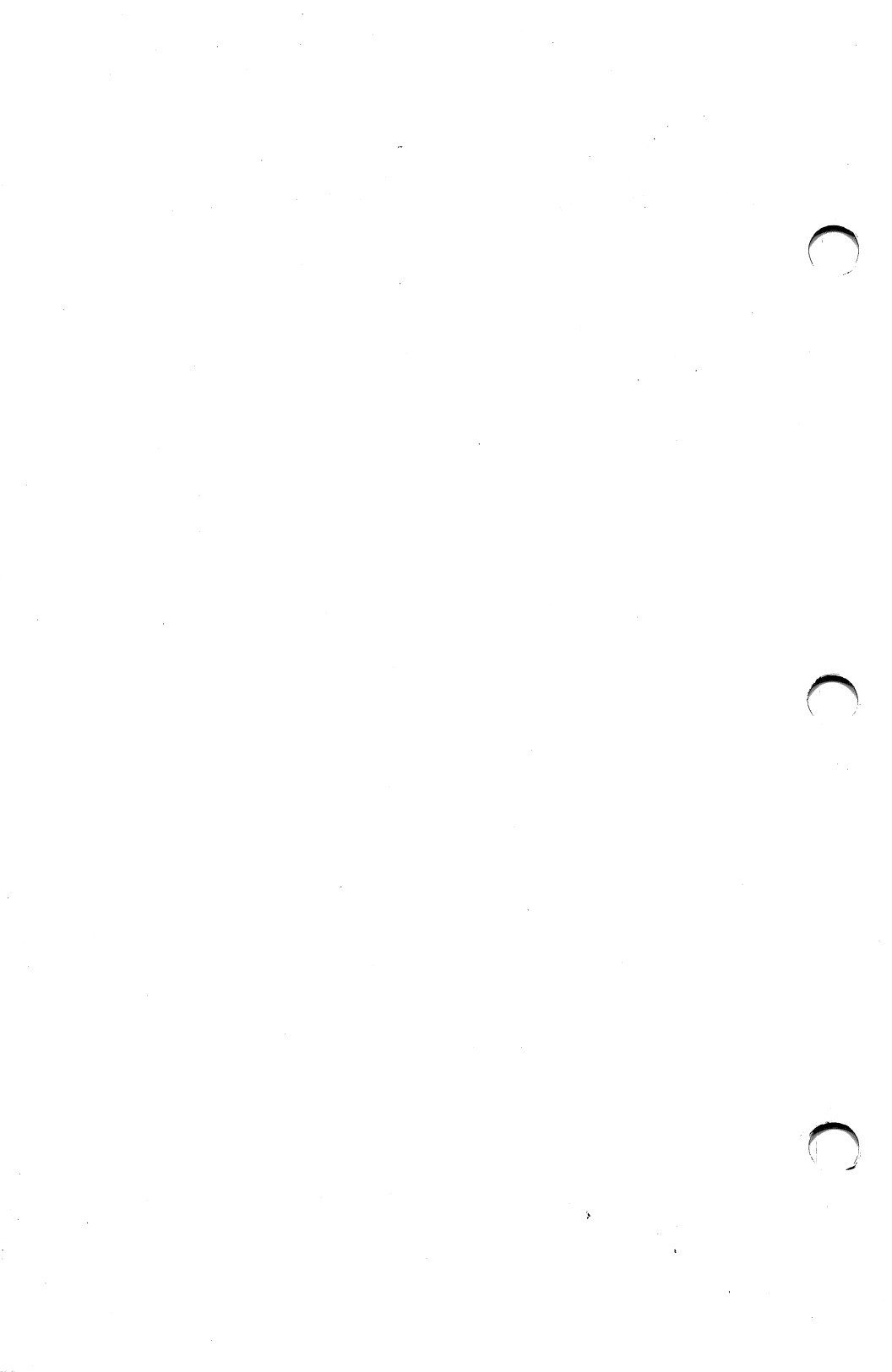

IMPORTANT: *This system is labeled for the configuration of power (115 Volt or 230 Volt) it was shipped with. Should you wish to use the system in a different power setting, contact your dealer for assistance.*

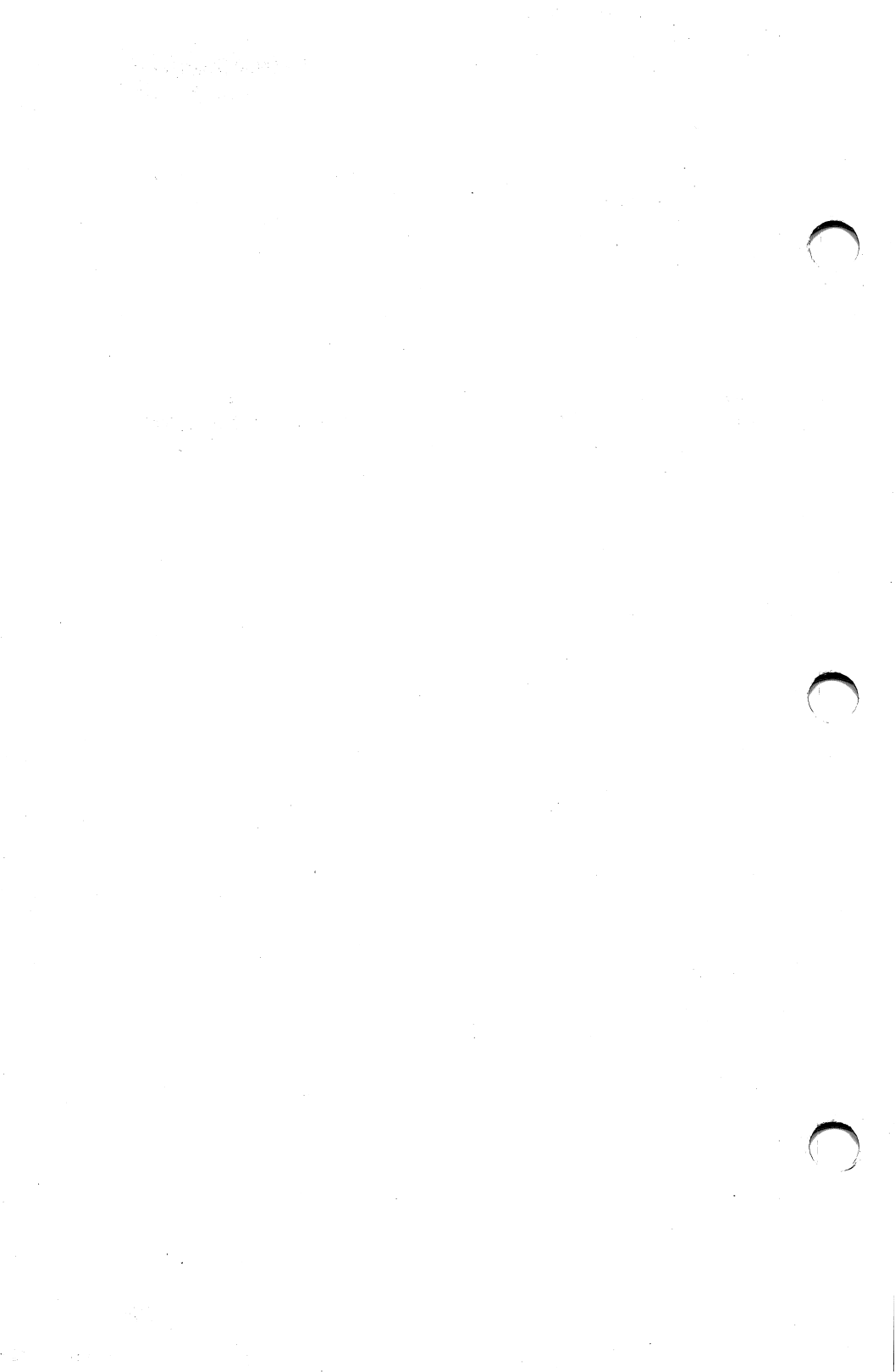

PC-400/PPC-400 USER'S GUIDE

NOTICE

This addendum provides information about emulation of IBM graphics. The following pages should be added after page 2-4 in your manual.

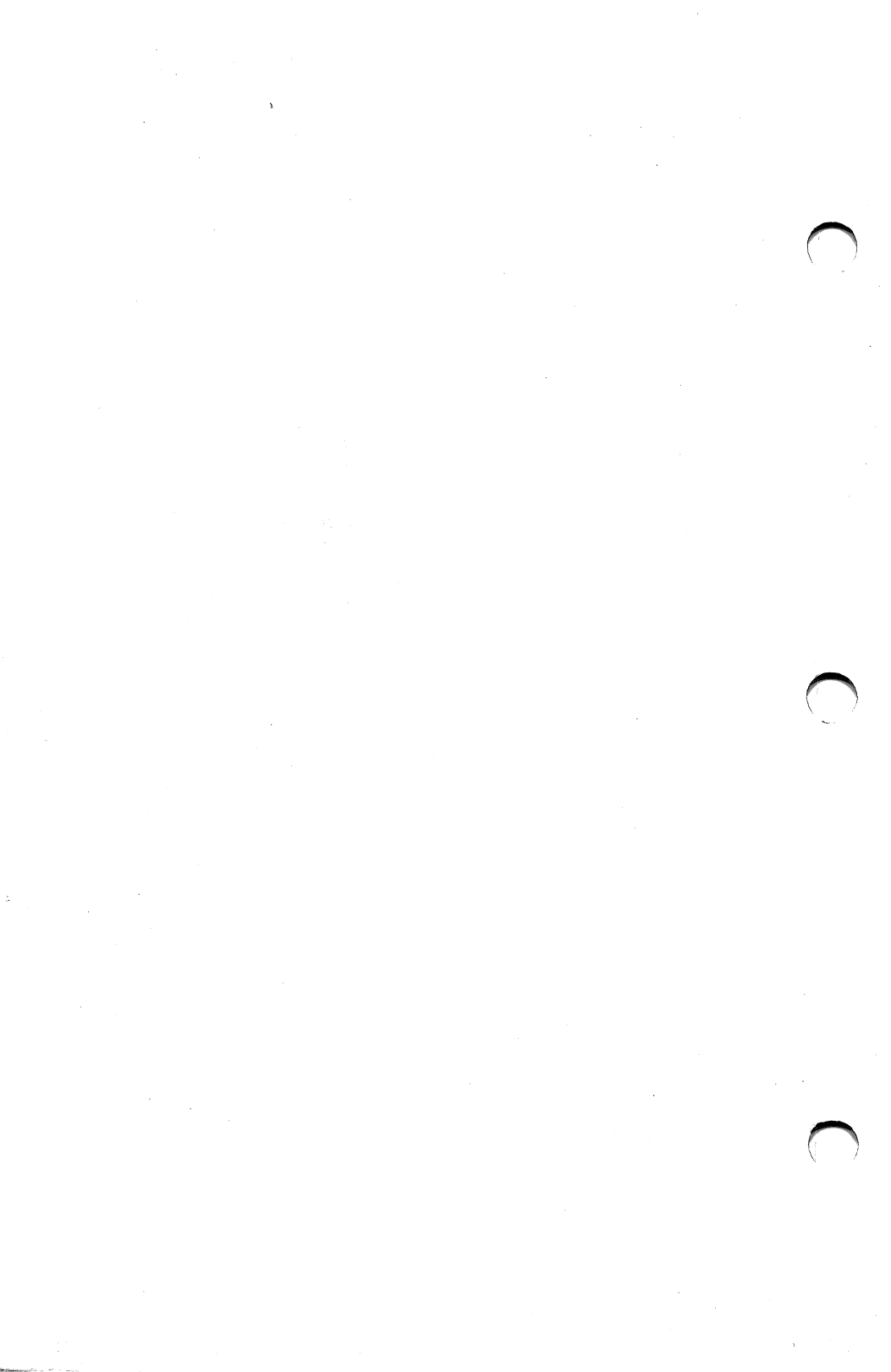

IBM Graphics Emulation

The super-resolution monitor can be used to emulate via software IBM text and graphics modes that normally would be displayed using a color card with a 200-line color monitor. The PC-400 and PPC-400 can emulate all seven IBM screen modes:

- 40 x 25 text (modes 0 and 1); two pages of text are available
- 80 x 25 text (modes 2 and 3); one page of text is available
- IBM medium-resolution graphics (modes 4 and 5)
- IBM high-resolution graphics (mode 6)

The IBM emulation has some special features that the user must be aware of when running certain software packages.

1. The emulation of IBM graphics can only be guaranteed for systems with up to 512K RAM installed. This is because the mapping of the IBM graphics memory to the top 16K of RAM is limited to systems with 512K or less RAM installed. Therefore if more memory is installed on an expansion card so that the total memory exceeds 512K, IBM graphics memory is still mapped to the top 16K of the 512K of RAM on the main board but is not protected from DOS or any other application program.

2. The 40 x 25 text modes have been emulated by using the 80 x 25 text screen and only letting half the screen be used. Therefore the wide text characters seen on the IBM for this mode are not generated on these machines.
3. The use of color text modes 1 and 3 could result in some text not being visible. This is because a color character can only appear on the 400-line monochrome screen as black, white, or either of these underlined. Since the screen background is either black or white, the situation can arise where black characters are written on a black background and white on white.

The following combinations of color text produce blank lines, that is, nothing appears on the screen:

- Black foreground on black background
- Black foreground on green background
- Black foreground on red background
- Black foreground on brown background

Note also that dark blue foreground on any background produces underlined characters on either black or white background.

Intensity has no effect on the above.

NOTE: This problem is resolved on most software packages by executing the DOS command MODE MONO before running the program. Refer to the DOS manual for information on the MODE command.

CONTENTS

1. INTRODUCTION	
Product Description	1-2
How to Use This Guide	1-3
Additional Information	1-5
Initialization Procedures	1-5
2. HARDWARE CAPABILITIES AND FEATURES	
The System Unit	2-1
The Monitor	2-1
Alphanumeric	2-3
Super-Resolution Graphics	2-4
Combined Alphanumeric and Graphics	2-4
The Keyboard	2-5
3. HARDWARE OPTIONS	
Co-Processors	3-1
Interface Boards	3-1
Printers	3-1
Drives	3-2
4. SOFTWARE CAPABILITIES AND FEATURES	
The Operating System: DOS 2.xx	4-1
IBM PC-Compatible Packages	4-2
5. INSTALLATION	
Inspecting the Computer Site	5-1
Tools You Will Need	5-3

Connecting the System's Components	5-3
Before Installation	5-3
Connecting the Keyboard	5-4
Connecting the Monitor	5-6
Connecting Power	5-10
Removing Head Protectors	5-11
The Main Board	5-11
Accessing the Desktop's Main Board	5-14
Accessing the Portable's Main Board	5-15
Expansion Slots and Interface Cards	5-19
Serial and Parallel Ports	5-22
To Use a Port	5-23
Jumpers for the Serial Port	5-23
Switch Settings	5-24
Other Connectors, Plugs and Jumpers	5-27
Adding an 8087 Co-Processor	5-29
Upgrading Memory	5-30
Initialization of the Hard Drive	5-32
Initialization of Diskettes	5-32
Relocating the System	5-32
To Remove the Monitor Cable (Desktop Only)	5-33
To Remove the Keyboard Cable	5-34
6. OPERATION	
About Disks and Diskettes	6-1
How Information is Recorded	6-2
The Differences Between Hard Drives and Diskettes	6-4
Reading And Writing to Hard Drives and Diskettes	6-4
Write-Protecting a Diskette	6-5
Handling Diskettes	6-7
Inserting Diskettes	6-8

Using the Computer 6-8
 Power On 6-8
 Resetting the System 6-11
 Power Off 6-11
Using the Keyboard 6-12
 Keys on the Left of the Keyboard . 6-12
 Keys on the Right of the Keyboard . 6-14

7. DOS 2.xx

 Booting With DOS 2.xx 7-2
 Entering A New Date 7-3
 Entering A New Time 7-3

APPENDICES

A CONNECTOR PIN ASSIGNMENTS A-1
B SPECIFICATIONS B-1
C MAINTENANCE C-1
D CARE AND HANDLING OF THE HARD DRIVE . D-1

GLOSSARY G-1
INDEX I-1

FIGURES

2-1	The Desktop System Modules	2-2
2-2	The Portable System Modules	2-3
5-1	Connecting the Keyboard Cable to the Keyboard	5-5
5-2	Connecting the Keyboard to the Desktop System Unit	5-5
5-3	Connecting the Keyboard to the Portable System Unit	5-6
5-4	Connecting the Monitor Cable to the Desktop System Unit	5-8
5-5	Rear View of the Desktop Monitor. . .	5-9
5-6	Rear View of the Portable System Unit	5-10
5-7	The Desktop Main Board	5-12
5-8	The Portable Main Board	5-13
5-9	Front Bottom Screws	5-16
5-10	Back Top Corner Screws	5-17
5-11	Removing an Expansion Slot Cover . .	5-21
5-12	Side View of an Interface Card . . .	5-22
5-13	Setting the Switch	5-25
5-14	Pin 1 Location	5-30
6-1	Divisions of a Diskette	6-3
6-2	Adding Write-Protect to Diskette . .	6-6
6-3	Inserting a Diskette in the Desktop Drive	6-9
6-4	Inserting a Diskette in the Portable Drive	6-10
6-5	The Keyboard	6-13

Section 1

INTRODUCTION

Welcome to the growing family of Corona personal computer owners. The sophisticated and easy-to-use computer hardware and software of this microcomputer have been created with your needs in mind.

The Corona PC-400 (desktop) and PPC-400 (portable) are 16-bit personal computer (PC) systems compatible with off-the-shelf software and peripheral cards that conform to the popular IBM PC standard.

All of the basic components are built into the Corona PC. This reduces cost, complexity, and servicing. A wide variety of options is available so your Corona PC can be custom-tailored to meet changing personal or business needs at any time. Some of the features of the Corona PC are:

- State-of-the-art super-resolution graphics.
- The ability to use both alphanumerics and graphics on the screen at the same time.
- Super-resolution green or amber phosphor screen.
- Single "main board".

- 16-bit, 8088 processor.
- 256K of memory.
- DMA diskette drive controller.
- Hard drive controller; IBM XT compatible.
(Uses 1 expansion slot on hard drive model only.)
- One serial RS-232C port.
- One parallel Centronics signal-compatible port.
- Four IBM PC-compatible expansion slots.
- DOS 2.xx operating system (XT compatible).
- PC TUTOR.

A wide variety of software packages are available, and some may be bundled (shipped with the product). Please see Appendix B, Specifications, for further information.

PRODUCT DESCRIPTION

The Corona PCs are available in a desktop and portable model.

The Desktop PC-400 has all the standard features with a choice of one of the following configurations:

1. Two half-height diskette drives and a 10MB hard drive.
2. One diskette drive and a 10MB hard drive.
3. Two diskette drives.

The Portable PPC-400 has all the standard features with a choice of one of the following configurations:

1. One half-height diskette drive and a half-height 10MB hard drive.
2. Two half-height diskette drives.

HOW TO USE THIS GUIDE

The purpose of this guide is to introduce you to your new Corona PC, to instruct you on how to set up and use your Corona PC, and to be a handy reference guide after you are more familiar with your new computer.

This guide is divided into the following sections:

Section 1, INTRODUCTION, describes the Corona PC and the documentation provided with it.

Section 2, HARDWARE CAPABILITIES AND FEATURES, details each module of the Corona PC, describing its use, benefits, and features.

Section 3, **HARDWARE OPTIONS**, gives an overview and description of the various hardware options available to you as a Corona PC owner.

Section 4, **SOFTWARE CAPABILITIES AND FEATURES**, gives an overview of the operating system provided with the Corona PC, and the use of IBM PC-compatible software packages.

Section 5, **INSTALLATION**, describes the hardware in more detail, and gives step-by-step instructions on how to set up the Corona PC for the first time.

Section 6, **OPERATION**, lists the power on, power off procedures, and outlines the care and handling of diskettes and the computer itself. It also describes the keyboard.

Section 7, **DOS**, outlines the DOS operating system.

Appendix A, **CONNECTOR PIN ASSIGNMENTS**, provides printer cable information.

Appendix B, **SPECIFICATIONS**, lists the specifications of your system.

Appendix C, **MAINTENANCE**, gives cleaning procedures, and helpful hints on maintaining your computer.

Appendix D, **CARE AND HANDLING OF THE HARD DRIVE**, contains important information you should read about your hard drive.

A Glossary and Index are also provided.

ADDITIONAL INFORMATION

This User's Guide covers all the basics on how to use your new computer and familiarizes you with the operating system included with it.

Each Corona PC also includes separate documentation for:

The DOS 2.0 manual explains the functions and applications of DOS.

PC TUTOR is designed for the person who is using a microcomputer for the first time. It is a self-teaching program on a diskette that is included with this manual. PC TUTOR is a good place to begin after reading about booting a DOS 2.xx diskette (Section 7).

In addition, manuals for bundled (shipped with the product) software are also provided.

INITIALIZATION PROCEDURES

Please note that this manual is intended only to help you install your computer. Separate steps are necessary to initialize diskettes and a hard drive and to use the software provided. After reading this manual, refer to the DOS 2.0 manual for specific instructions.

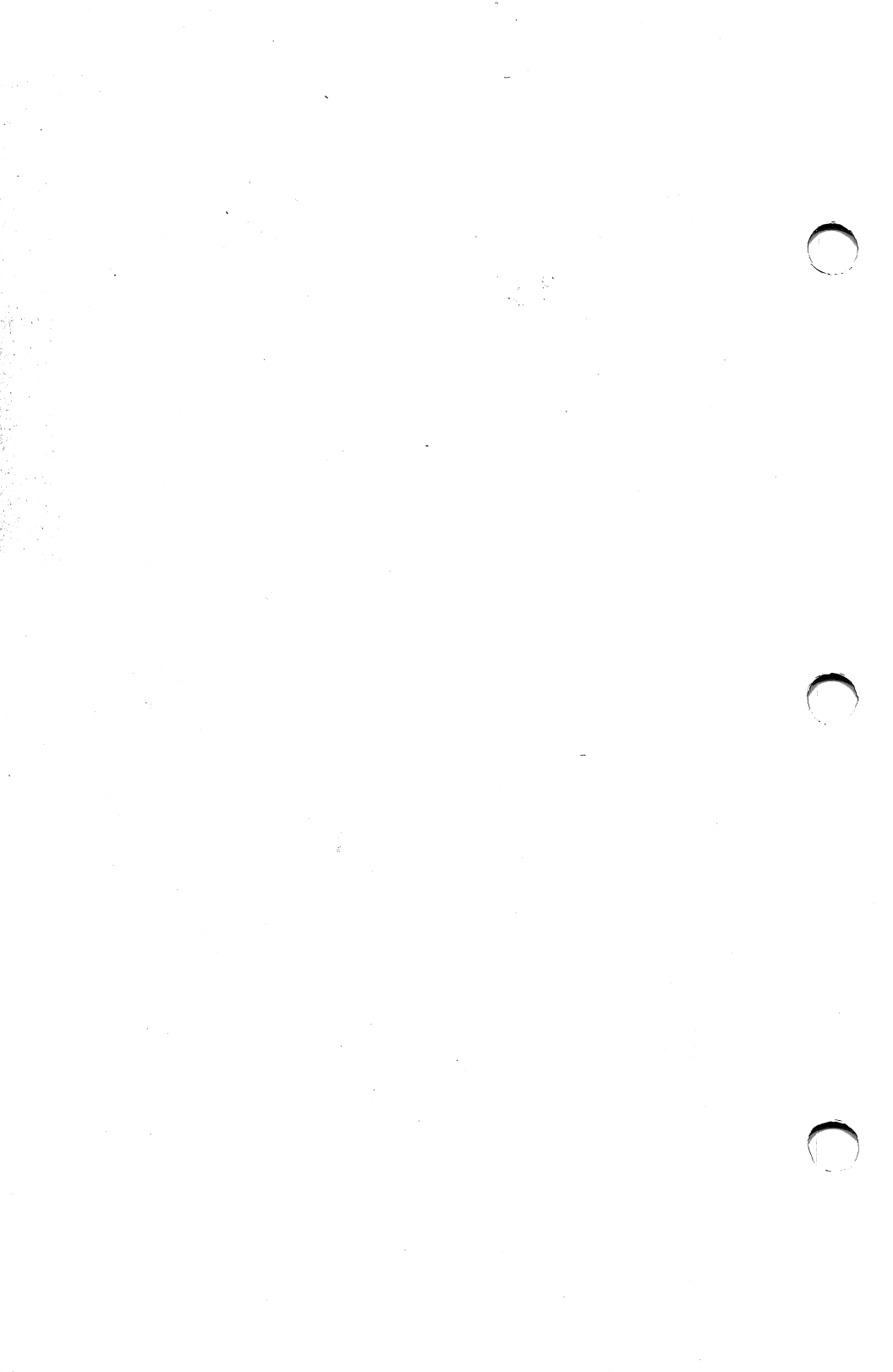

Section 2

HARDWARE CAPABILITIES AND FEATURES

The Corona PC is a 16-bit computer system designed specifically to be compatible with off-the-shelf software and peripheral cards that conform to the popular IBM PC standard.

A Corona desktop PC consists of three modules: the system unit, the monitor, and the keyboard (see Figure 2-1).

The Corona portable PC consists of two modules: the system unit and monitor are one piece, and the keyboard is detachable (see Figure 2-2).

THE SYSTEM UNIT

The system unit contains the main board, memory, ports, expansion slots, disk drives, power supply, and other hardware used to run the PC.

THE MONITOR

Provided with each desktop Corona PC is a 14-inch diagonal super-resolution monitor, with a green or amber phosphor screen. The portable has a built-in 9-inch monitor.

THE SYSTEM

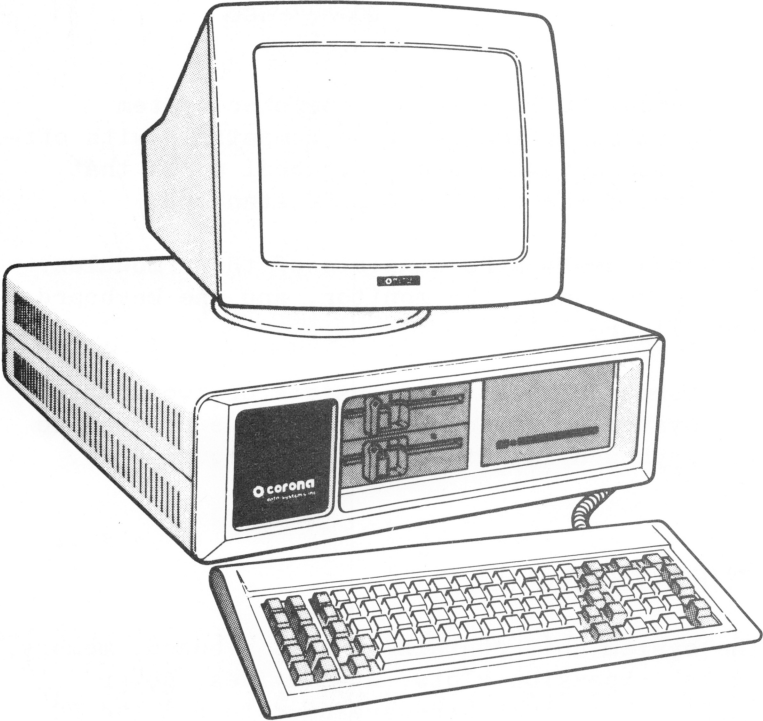

Figure 2-1. The Desktop System Modules

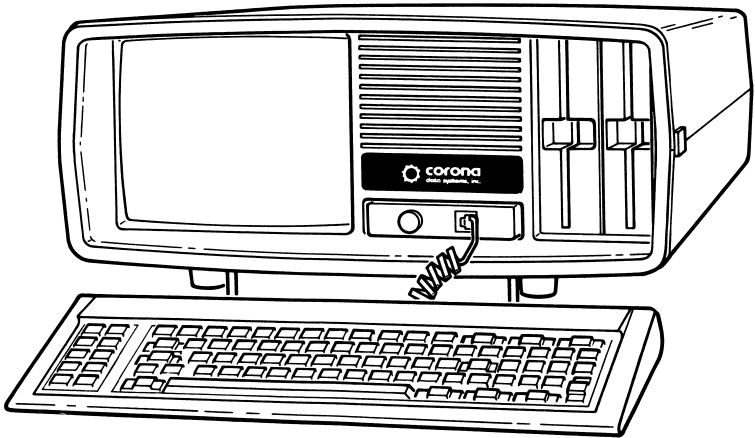

Figure 2-2. The Portable System Modules

Alphanumerics

The Corona PC uses 16 x 16 pixel characters, enhanced from IBM's 9 x 14.

As part of Corona's continuing effort to provide you with the finest and most advanced products, each character on the screen can be displayed with any combination of the following:

1. Normal or reverse video.
2. Underlining.
3. Blinking or nonblinking.
4. High or low intensity.

Super-Resolution Graphics

Built in to each Corona PC is 640 x 400 pixel, super-resolution graphics. This is twice the resolution found on the IBM PC.

The circuitry controlling the graphics capabilities in the Corona PC is resident on the main board.

NOTE: To print graphics you must have a printer with graphics capability.

As you look at your monitor, it seems as if the characters displayed there stay constant. Actually, the entire screen is constantly being refreshed (redisplayed). It happens so fast on the Corona PC that you never notice it.

Combined Alphanumerics and Graphics

A Corona PC lets you overlay graphics on top of alphanumerics. This provides you with the means for some very impressive displays.

NOTE: Using normal or reverse video, blinking or nonblinking characters, underlining, super-resolution graphics and combined alphanumerics and graphics are functions of the GWBASIC programming language.

THE KEYBOARD

Provided with your Corona PC is an improved, fully detachable keyboard that is functionally compatible (the same keys do the same things) with the IBM PC keyboard. Refer to "Using the Keyboard" in Section 6 for more information.

The six-foot extension cord provided with the keyboard gives you a great deal of freedom in positioning the computer in your work area.

On the keyboard are ten programmable function keys. These function keys are used by DOS and various application programs to perform special or often-repeated functions. This will save time because instead of having to type a command manually, all you have to do is press a function key.

Also included on the keyboard is the "PrtSc" (PRinT SCreen) key. The PrtSc key is used to print what is displayed on your monitor. Note that to print graphics displayed on your screen you must have a printer with the necessary capabilities.

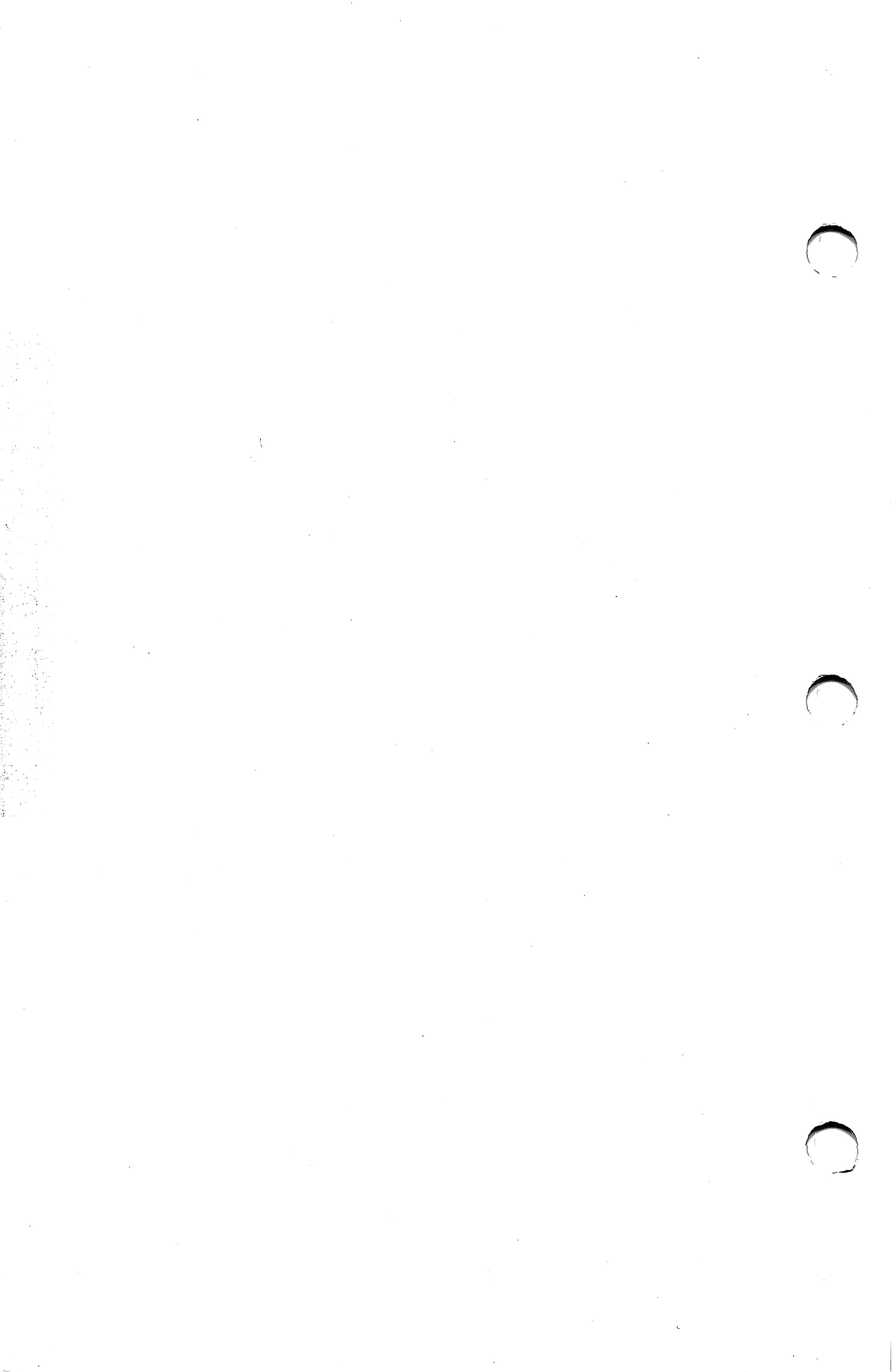

Section 3

HARDWARE OPTIONS

CO-PROCESSORS

An 8087 math co-processor can be added to the Corona PC. The 8087 co-processor is a chip that works in conjunction with the 8088 processor to increase the speed of arithmetic computing. Special software is also required in order to make use of the 8087. See Section 5 for installation instructions.

INTERFACE BOARDS

Most IBM PC-compatible boards can be added to the Corona PC. Modems, color graphics and a multitude of other IBM PC-compatible interface cards are available. Refer to Section 5 for instructions on where to install these boards.

PRINTERS

Any Centronics parallel compatible printer or printer with a serial interface can be used with the Corona PC. Refer to Appendix A for

connector pin assignments. (Refer to "MODE", "PRINT" and "GRAPHICS" in Section 4 of the DOS 2.0 manual for instructions on printing.)

DRIVES

If you do not have a full configuration on your system and wish to upgrade, a diskette or hard drive may be added. Refer to "Product Description" in Section 1 for configuration details.

HARDWARE

Section 4

SOFTWARE CAPABILITIES AND FEATURES

Each Corona PC comes with DOS 2.xx and PC TUTOR.

DOS 2.xx is an operating system.

PC TUTOR is a self-teaching guide for learning to use the Corona PC.

THE OPERATING SYSTEM: DOS 2.xx

DOS (Disk Operating System) 2.xx is almost identical to the DOS 2.xx used by the IBM PC. Any diskette that runs on the IBM PC will also run on the Corona PC. Corona DOS 2.xx and the IBM DOS 2.xx diskettes are interchangeable.

Please refer to the DOS 2.0 manual for complete instructions on the use of this system.

NOTE: The Corona PC can be used to run a large number of off-the-shelf application packages.

IBM PC-COMPATIBLE PACKAGES

The Corona PCs are compatible with the IBM PC software that uses standard DOS 2.xx and BIOS calls. The diskettes in the package designed for the IBM PC can also be used with the Corona PC.

This compatibility assures you of an ever-increasing supply of sophisticated, reliable, and readily available software packages.

Section 5

INSTALLATION

INSPECTING THE COMPUTER SITE

1. Is the power clean?

Arrange for a dedicated electric line or a surge protector, especially if there is heavy equipment in use near the computer site.

2. Will the computer be near a window?

Put up a shield to protect the system unit and diskettes from the intense heat of direct sunlight.

3. Is there static?

Use an anti-static mat or spray the rug once a week with one part laundry fabric softener diluted with ten parts water.

4. Is there a microwave, magnetic based copier, or any other magnetic device in the room?

These devices can affect the performance of your computer. Keep the computer as far as possible from them. Magnetic fields can also destroy data on diskettes.

Site Inspection

5. Do you have enough room for your computer?

If your computer is in a cramped space, keep an eye on the cable running to your system unit. If your computer stops running, the cables might have jarred loose. Also, do not cover any of the ventilation slits on the system modules.

6. Is your computer going to be on the same table as a printer?

Consider whether vibration from the printer will affect your comfort in using the computer.

7. Will the computer be in a room full of smokers?

Smoke is made up of particles, just like dust. Particles can cause read or write errors during diskette operations. If you are going to be in a smoke-filled room, take extra care to protect your diskettes. Keep them in their envelopes, and store them in their boxes or in other storage devices available for diskettes.

Generally speaking, if you are comfortable, so is your computer. If the air temperature is comfortable, if there is no sunlight beating down on you, if there is no static electricity around you, if you have room to turn around in, and if the air quality is good, then your computer site is a good one.

For the specifications of your PC, refer to Appendix B.

TOOLS YOU WILL NEED

You will need a small flat-head screwdriver for the monitor cable, and if you need to get inside the computer, you will need a Philips screwdriver.

CONNECTING THE SYSTEM'S COMPONENTS

All you need to do is to plug the three modules of the Corona PC together with simple cables, and it is ready to use. (The portable PC has only two modules.) There is nothing to take apart unless you need to add an option inside the system unit.

Before Installation

1. Remove each of the modules from its packing materials, and save the packing materials.

Be careful not to drop the modules or bang them around.

2. Place the modules in such a manner that you can reach over, under, and behind them.

Connecting Components

3. MAKE SURE THE POWER SWITCH ON THE BACK OF THE SYSTEM UNIT IS TURNED OFF, AND THAT NONE OF THE COMPONENTS ARE PLUGGED INTO AN ELECTRICAL OUTLET.

Connecting the Keyboard

The coiled six-foot cable that goes to the keyboard has identical connectors on each of its ends just like the connectors found on modular telephone cords. The connectors are "keyed", which means that they can only be plugged in one way.

1. Turn the keyboard upside down.
2. Plug either end of the coiled cord into the connector provided on the keyboard (Figure 5-1).
3. Lift the system unit up so that you can see underneath it.
4. Plug the other end of the keyboard cord into the connector that is near the upper right-hand corner of the bottom of the system unit. (See Figure 5-2.)

If you have a portable, the connector is located on the front of the system unit. (See Figure 5-3.)

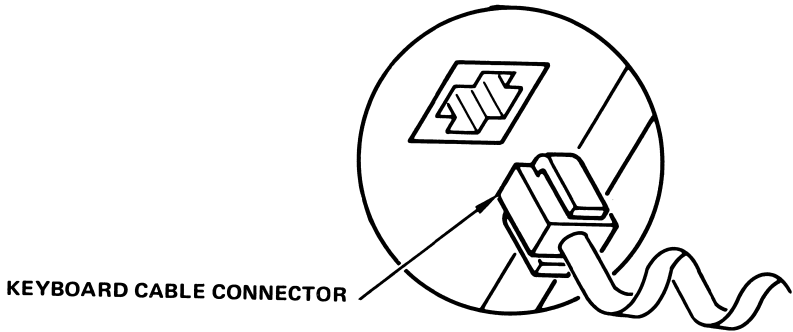

Figure 5-1. Connecting the Keyboard Cable to the Keyboard

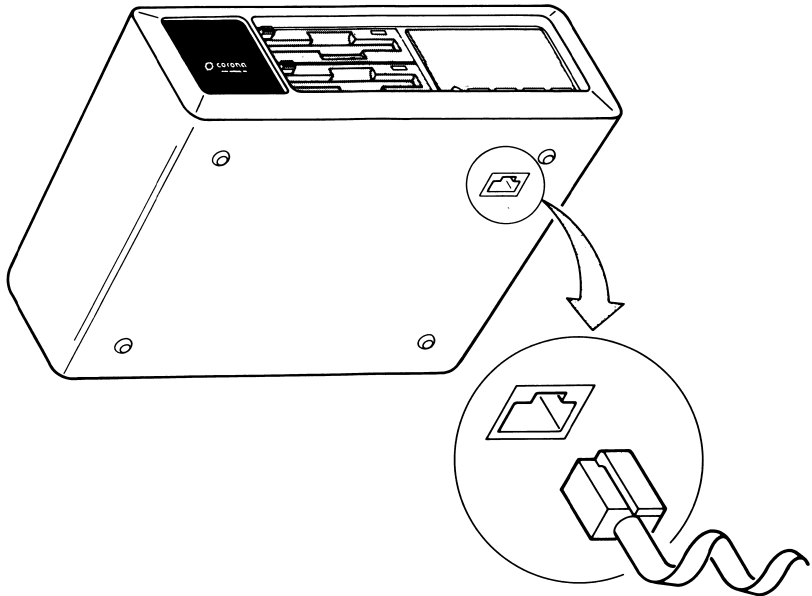

Figure 5-2. Connecting the Keyboard to the Desktop System Unit

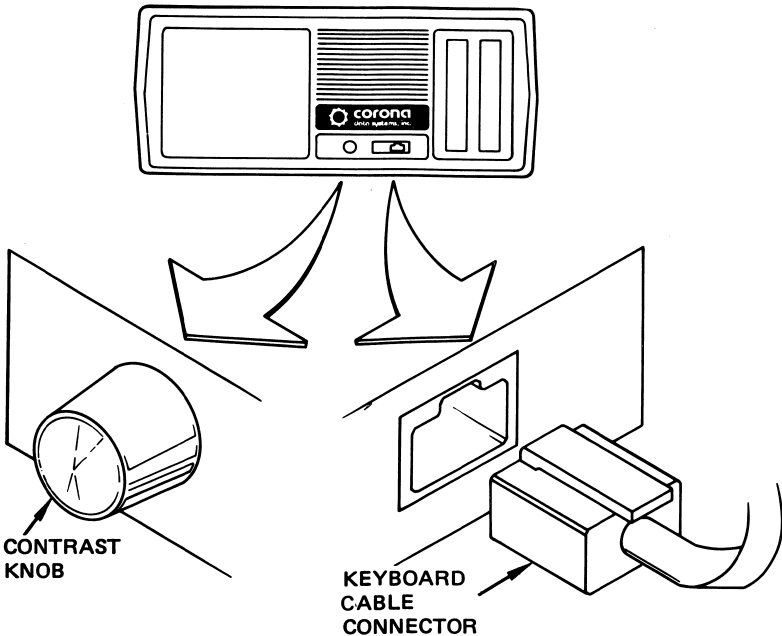

Figure 5-3. Connecting the Keyboard to the Portable System Unit

Connecting the Monitor

1. If you have a portable PC, the system unit and monitor are one piece. Go to the next section "Connecting Power". If you have a desktop PC, place the monitor beside, or on top of, the system unit. Do not put the monitor on top of the system unit until you have plugged in the keyboard.

The cable that runs from the monitor to the system unit has a 9-pin metal connector on each end. Some monitors have a permanent cable attached to them, and you need only connect the other end to the system unit.

2. Spaced along the back of the system unit are three connectors, two with 25 holes, and one with only nine. Take one end of the monitor connector and plug it into the nine-hole connector on the back of the system unit, making sure that it is turned in the correct direction. (See Figure 5-4.)
3. On each side of the 9-pin metal connector is a captive screw.

Take a small flat-head screwdriver and secure the connector to the system unit by screwing in the captive screws. You must alternate between each, turning the screw only part way. If you attempt to screw one of the screws all the way, the other will not seat properly.

4. Plug the other end of the monitor cable into the back of the monitor where it says "VIDEO". Refer to Figure 5-5 for location. Screw in the captive screws as explained above.

Connecting Components

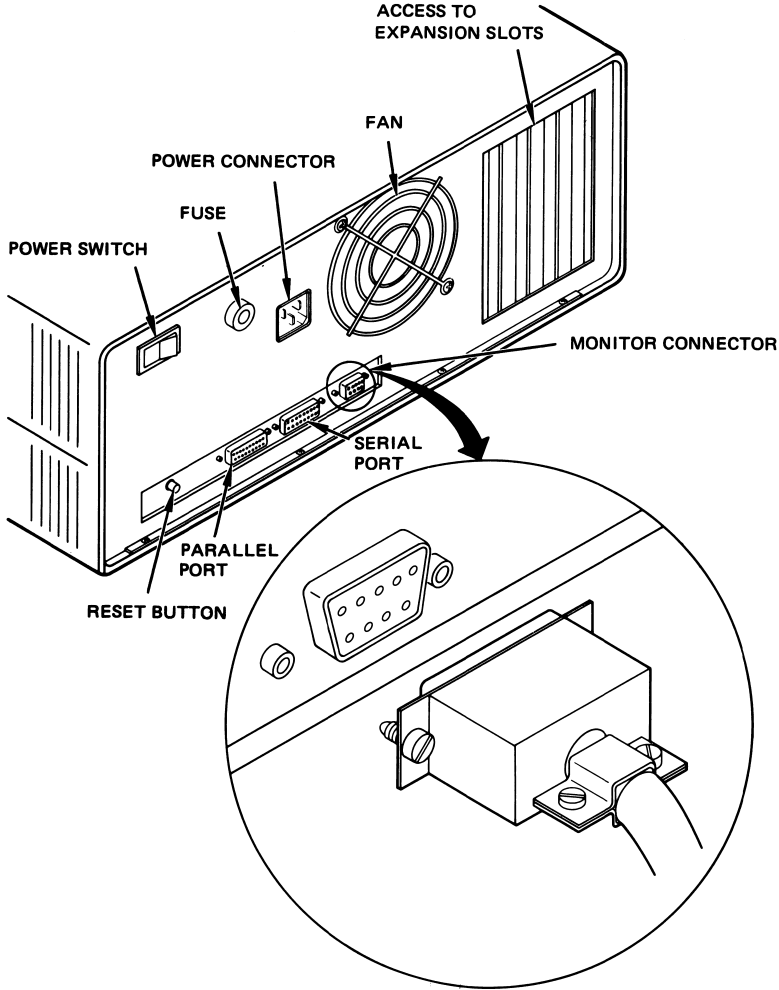

Figure 5-4. Connecting the Monitor Cable to the Desktop System Unit

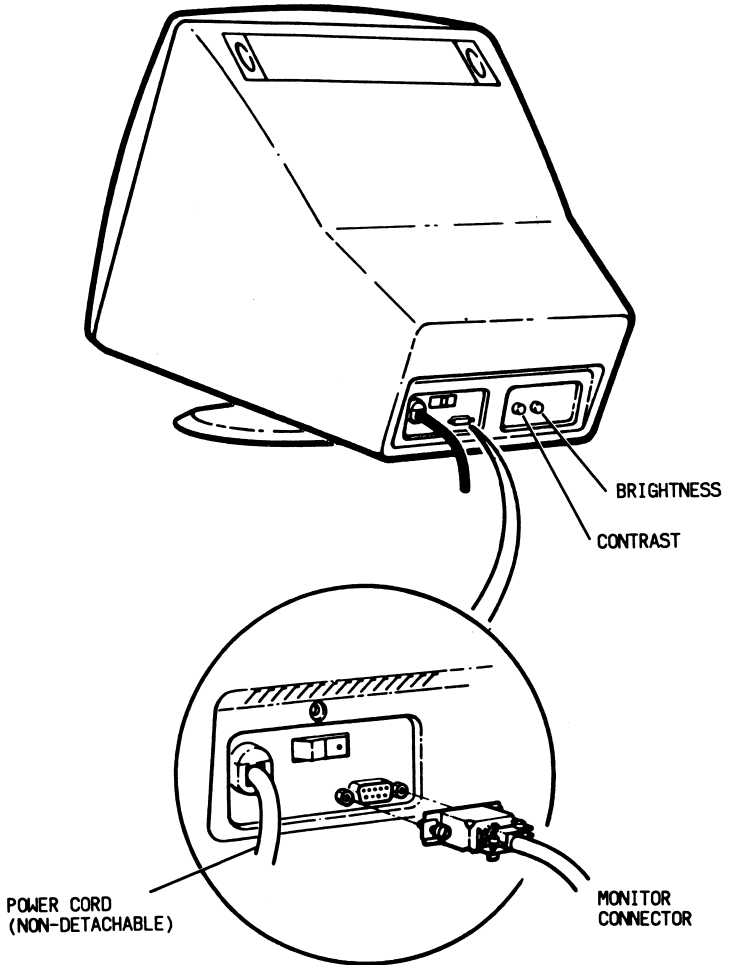

Figure 5-5. Rear View of the Desktop Monitor

Connecting Power

You are now ready to plug the monitor and the system unit into an electrical outlet.

1. Plug the power cord into the system unit. The power connector is shown in Figure 5-4. The power receptacle on the portable system unit is shown in Figure 5-6. There is only one cord that will lead from the portable system unit.
2. Plug the power cords from the system unit and the monitor into an electrical outlet. (The power cord coming from the desktop monitor is permanently attached.)

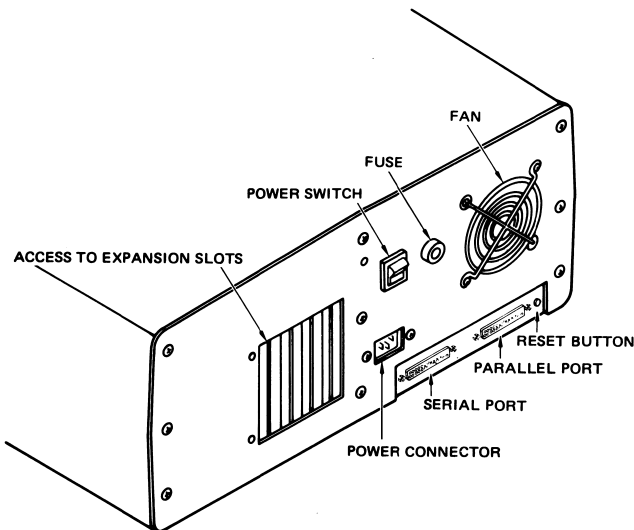

Figure 5-6. Rear View of the Portable System Unit

Removing Head Protectors

Inserted in the diskette drives are cardboard head protectors shaped like diskettes. These protectors prevent the read/write heads on the diskette drives from banging around and getting out of alignment during shipment.

1. Gently open the diskette drive latch or press the button.
2. Pull out the head protectors.

Save the protectors and use them any time you move your Corona PC. (Double-sided diskette drives are more susceptible to head damage during shipping than single-sided diskette drives.)

THE MAIN BOARD

The heart of the Corona PC is the Main Board. It contains the microprocessor (the computer itself), all the memory, the disk controller circuitry that runs the drives, the video controller that runs the monitor, graphics, serial and parallel ports, the four expansion slots, and other circuitry.

Putting everything on one board makes servicing and updating much easier. There is no need to disconnect cables running to other boards in order to remove one of the five or six boards found in most ordinary computers.

Main Board

Figure 5-7 is a diagram of the desktop's main board, and Figure 5-8 is a diagram of the portable's main board.

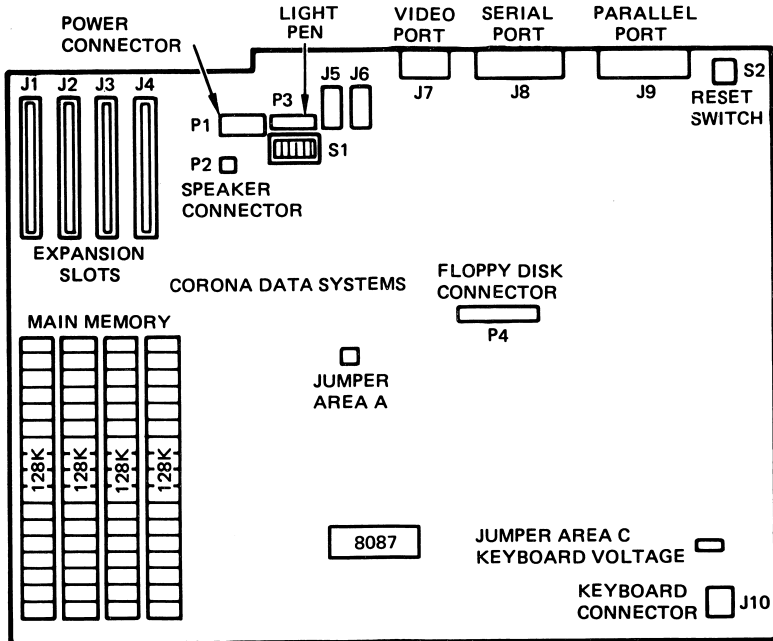

Figure 5-7. The Desktop Main Board

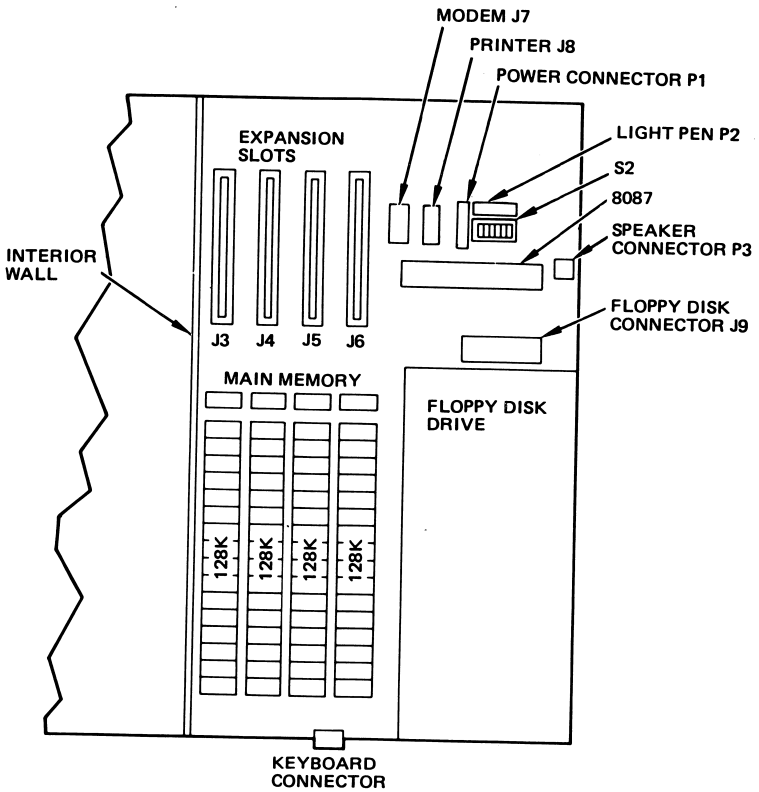

Figure 5-8. The Portable Main Board

Accessing the Desktop's Main Board

To access the main board for memory, co-processor or interface card installation:

1. Turn off the monitor and the system unit.
2. UNPLUG THE MONITOR AND SYSTEM UNIT FROM THE ELECTRICAL OUTLET.

Disconnect the monitor and keyboard from the system unit and place them so that they are out of your way.

3. Remove the four screws holding the top cover of the system's housing in place, and lift the cover off.

You will see a large green board covering the bottom of your Corona PC. That is the main board.

IN THE BACK RIGHT OF THE SYSTEM UNIT IS THE POWER SUPPLY WHICH IS PROTECTED BY A METAL MESH CAGE. DO NOT TOUCH ANYTHING INSIDE THE CAGE -- IT IS THERE TO PROTECT YOU FROM ELECTRICAL SHOCK.

You will also see the back of your drives and the manufacturer's boards for the drives. Please do not lean on the drives, place anything on them, bend any of the components on the drive boards, or otherwise tamper with them.

4. To separate the bottom of the system from the main chassis, remove all visible ribbon cables inside and out.

5. Remove all interface cards from expansion slots. For more information, see "Expansion Slots and Interface Cards" in this section.
6. Remove the power connector (P1) and the speaker cable (P2) (refer to Figure 5-7 for location) by gently pulling straight up.
7. Turn the system upside down, and place it on a soft surface.
8. Remove the eight outside screws only.
9. Turn the system back over.
10. Lift the main chassis up from the bottom cover about 5 inches and disconnect from the main board (P4), the cable leading from the floppy drive.
11. Continue lifting the main chassis out and set it aside.

The main board is now completely open for access.

Accessing the Portable's Main Board

To access the main board for memory, co-processor, or interface card installation:

1. Turn off the system unit and unplug it from the electrical outlet.
2. Disconnect the keyboard from the system unit, and place it out of your way.

Main Board

3. Remove two screws from the front bottom of the cover (see Figure 5-9).
4. Remove two screws from the back top left and top right corners of the cover (see Figure 5-10).
5. Carefully lift rear of top cover approximately 1 inch. (Cover will be free from rear plate of chassis.)

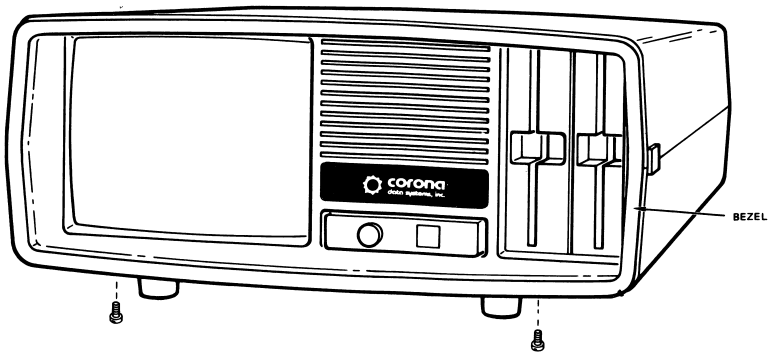

Figure 5-9. Front Bottom Screws

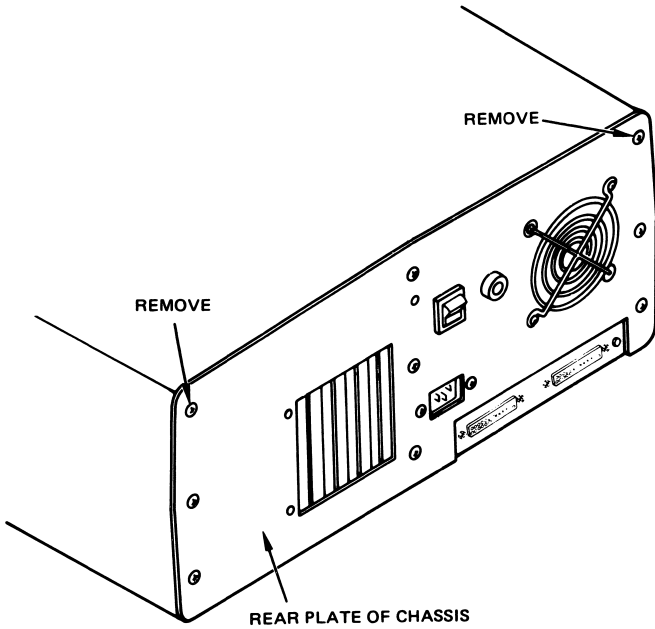

Figure 5-10. Back Top Corner Screws

6. While holding rear of top cover, gently pull on bottom of bezel where front screws were removed. Continue forward movement to separate the cover from the unit.

CAUTION

Raising the cover too high can cause the front bottom tabs to break.

You will see two metal shields, one over the monitor area (the left side) and one over the drive area (the right side).

7. Remove the eight screws from the metal shield on the right side (drive area) and lift the metal shield up and off.

WARNING

NEVER REMOVE THE COVER FROM THE LEFT SIDE (MONITOR AREA). THIS IS A DANGEROUS HIGH VOLTAGE AREA AND SHOULD ONLY BE SERVICED BY FIELD TECHNICIANS.

You will see a green board covering the bottom of the system. That is the main board.

You will also see your drives covered in another metal shield. Do not tamper with the drives.

The main board is now open for access.

When reassembling, be sure to engage tabs on cover with slots in chassis. Make sure the contrast control knob fits properly in its hole in front of the cover.

EXPANSION SLOTS AND INTERFACE CARDS

On the back left of the main board are four long, black, rectangular expansion slots marked "J1", "J2", "J3" and "J4" in the desktop (see Figure 5-7) and "J3", "J4", "J5" and "J6" in the portable (see Figure 5-8). There are many different products on the market that use these expansion slots. An example is a hard-wired modem (one that is installed inside your computer as an interface board rather than outside your computer as a small unit that sits by your phone).

To install interface cards into these expansion slots:

1. Turn off the power switch and remove the top cover of the system unit.

Interface Cards

2. Remove the expansion slot cover as shown in Figure 5-11. Save the screws. All expansion slots are the same and you may choose any one that is not in use.
3. The interface card has a retaining bracket similar to the expansion slot cover. The board can only be inserted one way. The retaining bracket fits in the same way as the expansion slot cover. Refer to Figure 5-12.
4. The expansion slot connector plugs into the expansion slot. Push the board straight down into the expansion slot until it is secure.
5. Secure the interface card at the retainer screw hole.

To remove the interface card, follow the steps above in reverse order, making sure that you remove any connector cable before lifting the card out. Lift straight up to remove card.

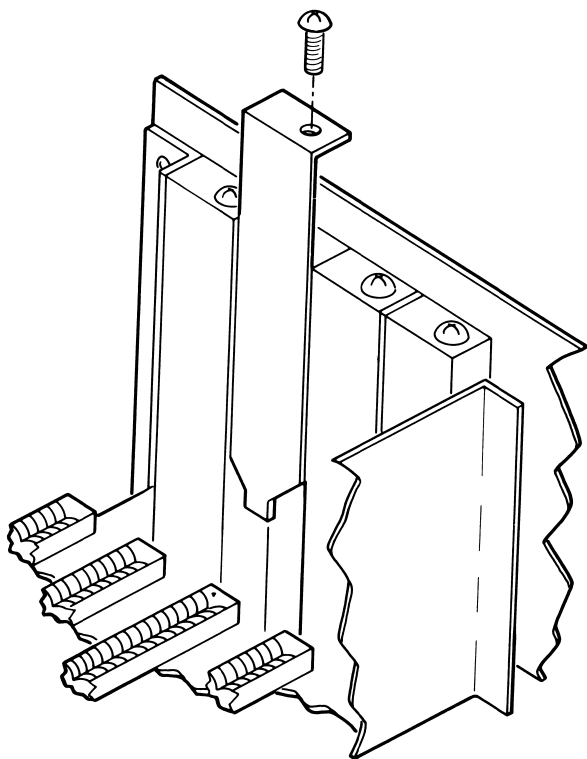

Figure 5-11. Removing an Expansion Slot Cover

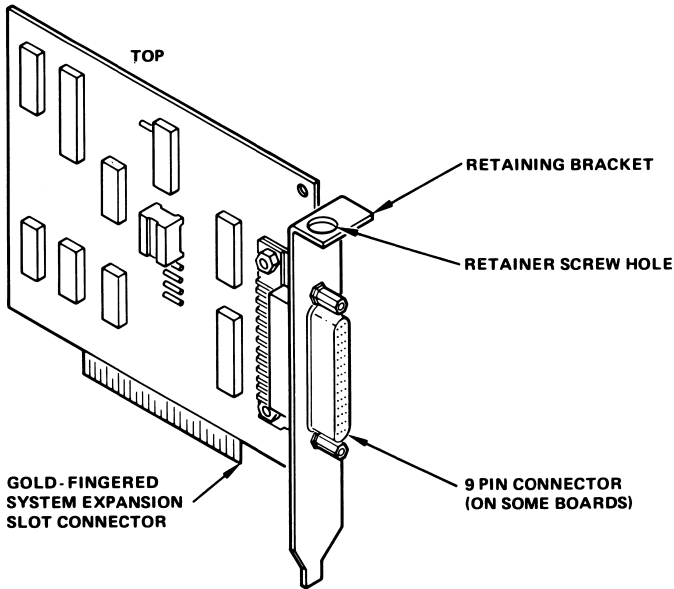

Figure 5-12. Side View of an Interface Card

SERIAL AND PARALLEL PORTS

The parallel port is a printer port. The serial port can be used either as a printer port or as a communications port.

The serial and parallel ports are located on the back right of the desktop's main board. On the portable they are on the back left of the main board. They extend through the system unit housing and become the two 25-pin connectors visible on the back of the system unit.

See Appendix A for a listing of the connector pin assignments for the parallel and serial ports.

To Use a Port

NOTE: Connection of peripherals to this computer should be done with shielded cables. Use of a non-shielded cable is likely to result in interference to radio and TV reception.

Plug a device (a printer or another peripheral) into the correct port.

The port used will depend on the printer or other peripheral you have.

The port closest to the monitor connector is the serial port and the one closest to the reset button is the parallel port. Refer to Figure 5-4 for location on the desktop. For the portable refer to Figure 5-6.

If you use the serial port, make sure the jumper platform is in the correct jumper area.

Jumpers for the Serial Port

The serial port has two jumper sockets on the main board: J5 and J6 on the desktop, and J7 and J8 on the portable. For locations refer to Figure 5-7 for the desktop and Figure 5-8 for the portable.

In one of the jumper sockets is a jumper platform, a black component the same size as a memory chip but having 8 pairs of metal connector fingers.

If the jumper platform is in J5 on the desktop, or J8 on the portable, the serial port is set up to control a serial printer (a DTE, "Data Terminal Equipment" device).

If the jumper platform is in J6 on the desktop, or J7 on the portable, the serial port is set up to control a modem (a DCE "Data Communications Equipment" device).

SWITCH SETTINGS

In the desktop, a red "DIP switch" (S1) with 6 white switches is located on the middle back of the main board, right below the fan that is mounted on the back wall of the system unit (Figure 5-7). See Figure 5-8 for the location of this switch (S2) in the portable. These six white switches control a variety of functions.

Switch 1 tells the computer if an optional 8087 co-processor is installed.

Switch 2 tells the computer how many diskette drives are installed.

Switches 3 and 4 define the default video output options. Switch 3 must be ON at all times for your computer to operate properly. Regardless of the switch setting, the video output can be redirected, after boot up, via software.

Switches 5 and 6 tell the computer how much memory is installed.

To change the settings use a ballpoint pen to gently move the switches into the desired position, as shown in Figure 5-13.

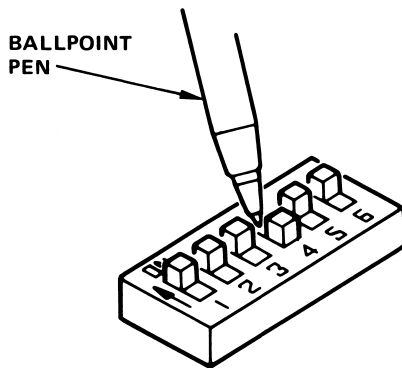

Figure 5-13. Setting the Switch

Switch Settings

The switch specifications are:

S1	ON	No 8087
	OFF	8087 installed

S2	ON	1 diskette drive
	OFF	2 diskette drives

S3 and S4	<u>S3</u>	<u>S4</u>	Video output directed to any allowable video connector (defaults)
	ON	OFF	

S5 and S6	<u>S5</u>	<u>S6</u>	128K of memory	
	ON	ON		
	OFF	ON		256K of memory
	ON	OFF		384K of memory
	OFF	OFF	512K of memory	

IMPORTANT

Switch 3 must be ON at all times for your computer to operate properly.

NOTE: The standard monitor has graphics and monochrome capability, so if color is desired, an IBM PC-compatible color board must be purchased along with a monitor that is compatible with the board.

Your machine has graphics capability and may include gray scale, which allows programs that require a color/graphics board to emulate color graphics on a monochrome screen, displaying the colors as four different shades of "gray".

The gray scale feature is only used in the medium resolution graphics mode (320 x 200).

OTHER CONNECTORS, PLUGS AND JUMPERS

The following are other connectors and jumper areas found on the main board of the desktop (Figure 5-7). Refer to Figure 5-8 for locations on the portable.

SPEAKER CONNECTOR: A small, two-pin connector with two wires running to the speaker.

Other Connectors

DC POWER CONNECTOR: A white plastic connector with six colored wires running from it to the power supply in the metal cage.

LIGHT PEN CONNECTOR: A six-pin connector directly above the red switch component and next to the power connector. A light pen is a device used by certain software programs to point to or draw something on the monitor screen. If you purchase a light pen, this is where you will connect it to your computer.

DISKETTE DRIVE CONNECTOR: A grey connector that the diskette drive(s) plug into with a flat ribbon cable.

KEYBOARD CONNECTOR: This connector goes all the way through to the outside of the system unit, where the coiled cable from the keyboard plugs into it.

JUMPER AREA A (desktop only): Located almost in the middle of the main board, to the left of the diskette drive connector. To access this jumper area you will have to remove the main board from the computer. This jumper area is pre-set at the factory, and you will not need to change it. "IN" specifies an 8K PROM and "OUT" specifies a 16K PROM. A 16K PROM is installed.

JUMPER AREA C (desktop only): Located on the bottom right of the main board. To access this jumper area, you will have to remove the main board from the computer. This jumper area is pre-set at the factory and you will not need to change it. It controls the voltage to the keyboard. Jumper 1-2 sets +12V for the keyboard, and jumper 2-3 sets +5V for the keyboard. The default is +5V.

ADDING AN 8087 CO-PROCESSOR

Access the main board and locate the empty 40-pin socket. In the desktop it is located directly under the drive(s). In the portable it is located directly next to the speaker connector (P3). Refer to Figure 5-7 for the desktop and Figure 5-8 for the portable. Insert the 8087 chip into the socket, making sure that pin 1 faces in the same direction as all other chips. (Refer to Figure 5-14 for pin 1 location.) To install the chip, gently push it into the socket. Make sure all the pins on the chip are in the holes of the socket.

The switch setting must be changed to let the computer know that the 8087 chip has been added. (Refer to "Switch Settings" in this section.)

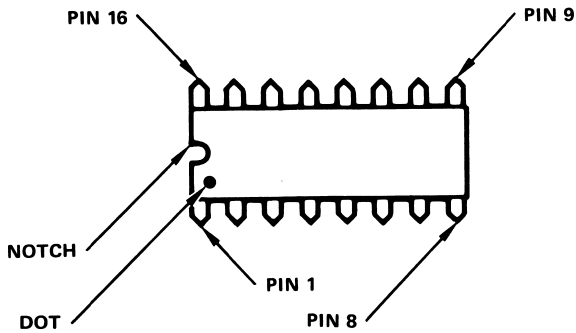

NOTE: FOR PIN 1 LOCATION,
IC CHIP COULD HAVE A
NOTCH, A DOT OR BOTH

Figure 5-14. Pin 1 Location

UPGRADING MEMORY

On the front left of the main board are four rows of 16 sockets (see Figure 5-7 or 5-8). The two rightmost rows are already filled with soldered in memory chips. This is your original 256K of memory. Memory is expandable to 512K.

To increase the amount of memory in your computer:

1. Turn off the power switch and remove the top cover of the system unit.

2. Always install a full row (16 chips), and always install a new row right beside the last filled row (do not skip a row).

IMPORTANT

When installing memory chips in the sockets, make sure that pin 1 of the chip is located in the same direction as the memory chips already installed. See Figure 5-14 for pin 1 location.

To install a chip, gently push it into a socket. Make sure that all the pins on the chip are in the holes in the socket.

3. Change the settings for switches 5 and 6 at S1 for the desktop or at S2 for the portable. See "Switch Settings" in this section for more information.

It is important that the same brand of chips already installed in the Corona PC be used. Mixing different kinds of chips will cause problems. Since memory chips are an important part of any computer, if poor quality chips are used, they can cause malfunctioning and loss of data.

INITIALIZATION OF THE HARD DRIVE

Refer to "PHDINIT" in Section 4 of the DOS 2.0 manual for specific instructions on initializing and using the hard drive.

INITIALIZATION OF DISKETTES

A blank diskette cannot be used straight out of the box because the computer cannot find its way around the diskette until the tracks and sectors have been marked. The DISKCOPY and FORMAT commands identify (mark) the tracks and sectors on the diskette so that it can be used. Please refer to these commands in Section 4 of the DOS 2.0 manual to initialize any new diskettes you will be using.

RELOCATING THE SYSTEM

The Corona PC is easy to move and set up, but moving it correctly helps insure the safety and reliability of your system. Please follow these suggestions.

Save the original packing cartons the computer was shipped in. The cartons are designed to cushion the computer from accidental jolts. Any move other than from room to room should include repacking the system.

NOTE: If you do not have the original shipping cartons, carefully pack the system in cartons that have plenty of cushioning on all sides.

It is important that head protectors be reinserted into the diskette drives to protect the read/write heads from damage during shipping. If the head protectors are not available, insert expendable diskettes into the diskette drives instead.

IMPORTANT

You must reposition the read/write heads on the hard drive before moving it. Refer to Appendix D of this manual and also the PARK command in the DOS 2.0 manual for instructions.

To Remove the Monitor Cable (Desktop Only)

Unscrew the captive screws on each side of the monitor connector in the back of the system unit and monitor (if it is not permanently attached to the monitor). Alternate back and forth between the two screws to assure proper alignment. If not aligned properly, the screws will become stripped.

Relocating the System

To Remove the Keyboard Cable

Press in the small latch on each of the connectors, and pull the connector out.

Section 6

OPERATION

In order to get the most benefit from your Corona PC, you will need to know the proper power on and power off sequences, how to take care of your diskettes, and several other care and handling tips.

ABOUT DISKS AND DISKETTES

The Corona PC uses 5 1/4 inch (133 mm), double-sided, double-density, soft-sectored diskettes, each holding 360K bytes of information. Such a diskette can actually hold 368,640 characters, which is equivalent to 248 book pages of information.

The hard drive supported by the Corona PC holds 10 megabytes of characters, or approximately 6,714 book pages of information.

Each diskette is encased in a black plastic jacket. When used, the diskette spins inside this jacket, and the read/write heads of the diskette drive contact the recording surfaces of the diskette through the oblong holes, called the "head slots".

Hard drives are enclosed in a sealed metallic case that is an integral part of the drive. When used, the hard drive spins inside this case, and the read/write heads of the drive come very close to the recording surfaces.

Do not ever open, crack, or otherwise tamper with the hard drive. The case around the drive keeps the interior free of all dust and particles, and tampering with that sealed environment will render the drive useless.

How Information is Recorded

Information is recorded on the surface of a hard drive or diskette in much the same way a tape recorder records sounds on a cassette or reel-to-reel tape.

A tape recorder uses long "tracks" (as in eight-track cassette) that run the length of the piece of tape.

A hard drive or diskette uses a series of round tracks arranged along the surface of the hard drive or diskette (as on a phonograph record). The Corona and IBM diskettes both use 40 tracks per side.

The tracks on a hard drive or diskette are divided into an equal number of "sectors", each sector containing the same number of usable "bytes" (characters). A sector in a track near the outside edge of the diskette is physically longer than a sector in a track nearer the center hole of the diskette (see Figure 6-1).

Hard drives and diskettes are physically mapped out in the same manner.

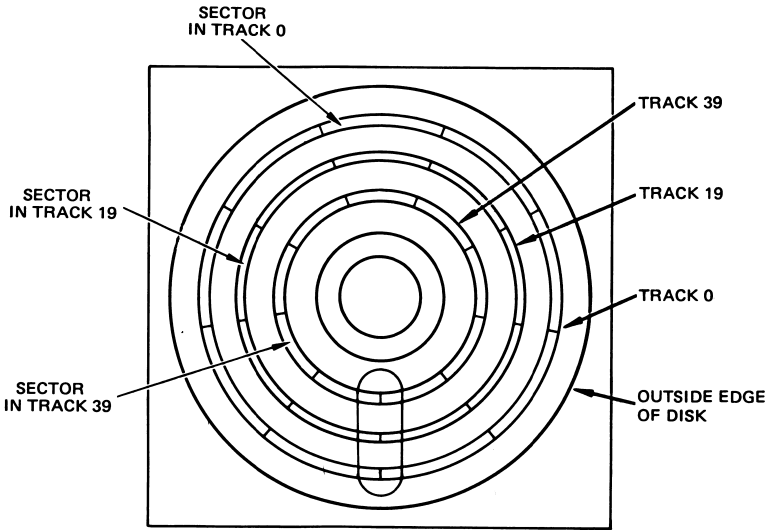

Figure 6-1. Divisions of a Diskette

The Difference Between Hard Drives and Diskettes

A diskette has one flexible disk. A hard drive has one or more rigid disks (platters) that are similar to the flexible disk inside a floppy diskette.

Because a hard disk is made out of rigid material it can spin much faster than a diskette. This increases the speed of operation.

A hard drive also holds more information than a diskette. It stores more information in the same physical area.

Reading and Writing to Hard Drives and Diskettes

The read/write head of the drive travels back and forth over the hard drive or diskette, from the edge toward the center hole and back again.

As the read/write head moves from one track to the next, the hard drive or diskette spins under it, moving each sector in turn into position under the read/write head.

The computer changes tracks by moving the read/write head and changes sectors by spinning the diskette or hard drive.

As with a tape recorder, you can record over old information on a hard drive or diskette. For instance, if you have a diskette with information you no longer need, that diskette

can be used for new information. However, if you accidentally write over information you need, it is gone forever. This is why it is a good idea to write-protect certain diskettes.

Write-Protecting a Diskette

Write-protecting is a method of telling the computer not to record any new information on a particular diskette. The diskettes you have received with your system should be write-protected. These are your "master" diskettes and should only be used to make a working copy. You should ALWAYS write-protect a diskette before you copy from it. This small action will prevent you from accidently copying the blank diskette onto the data diskette! After backup diskettes are made, be sure to keep all master diskettes in a safe place.

To write-protect a 5 1/4 inch diskette, simply place a write-protect tab over the notch on the side of the diskette (the tab must cover the entire notch on both sides). Write-protect tabs are the small, gummed rectangular stickers that come inside a box of diskettes.

If you run out of tabs, you can use any kind of tape that is not transparent. If your diskette has a notch on each side, the write-protect notch is the one on the right as you hold the diskette with the label facing you. (See Figure 6-2.)

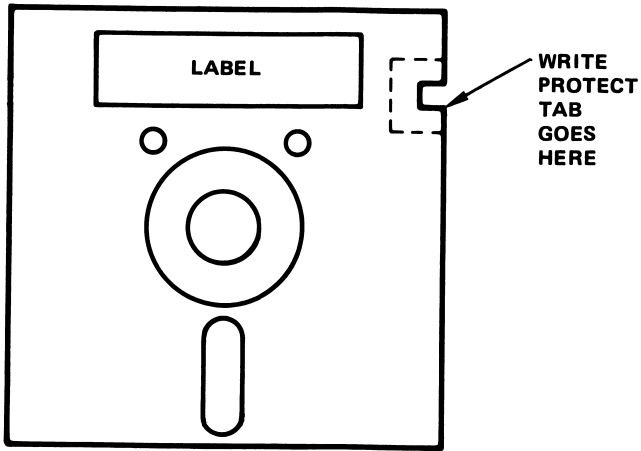

Figure 6-2. Adding Write-Protect to a Diskette

Handling Diskettes

Diskettes are an important part of your computer and it is very important that you take good care of them. The following tips will help you give them the care they need.

1. Write on labels before putting them on the diskette. If you have to write on a label already on a diskette, use a felt tip pen only. NEVER USE PENCIL.
2. Touch only the corner of the diskette. Never touch the open parts.
3. When the diskette is not in use, keep it in its protective envelope.
4. Do not bend the diskettes.
5. Do not put paper clips or any metal objects near the diskettes.
6. Keep diskettes away from sun and heat.
7. Never put a magnet near a diskette.
8. Never clean a diskette.
9. NEVER REMOVE A DISKETTE FROM A DRIVE WHEN ITS RED LIGHT IS ON!

The red in-use light is telling you that the computer is accessing the diskette (reading or writing to it). If you remove the diskette from the drive while the red light is on, you can seriously damage the read/write heads in the drive and/or the data on the diskette.

Inserting Diskettes

The drive must be open and the diskette removed from its protective envelope. The diskette is inserted into the desktop drive with the label facing upward and toward you (see Figure 6-3). The diskette is inserted into the portable drive with the label facing left and toward the monitor. (See Figure 6-4.) Push gently until the diskette clicks into place. Close the drive latch. NEVER FORCE A DISKETTE INTO A DRIVE AND NEVER FORCE THE LATCH CLOSED.

USING THE COMPUTER

Diskettes and hard drives are electromagnetic devices. You should plan to keep all computers and diskettes away from any equipment that generates heavy magnetic fields (x-ray machine, microwave, copier, telephone answering machine, etc.). Metal objects (paper clips, etc.) are magnetic, and you should be cautious in using them around your computer.

Power On

1. If you have a desktop, turn on the monitor by pushing the on/off switch located on the back of the monitor. If you have a portable, go to step 2.
2. Insert the DOS 2.xx diskette (or any bootable diskette) into drive A (the drive on top). The portable's drive A is on the left.

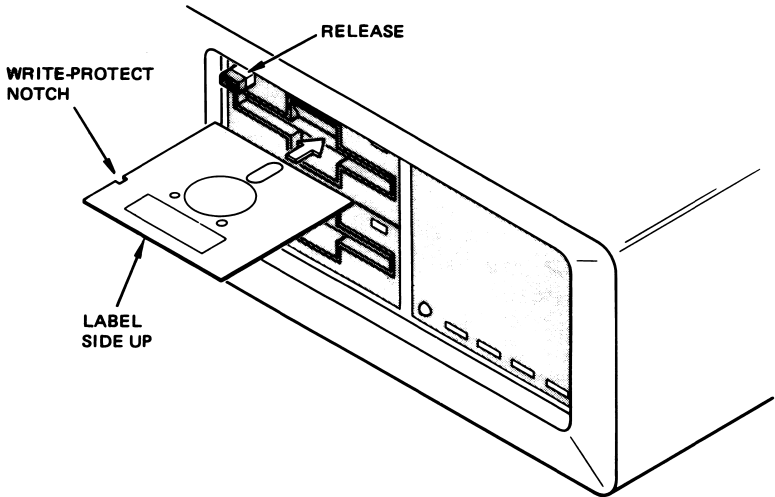

Figure 6-3. Inserting a Diskette in the Desktop Drive

3. Turn on the system unit by pressing the power switch on the back of the unit. Refer to Figure 5-4 for location of the switch on the desktop or to Figure 5-6 for location on the portable.
4. Adjust the contrast and brightness controls until the screen is easy to read. The contrast knob increases the distinction between normal and highlighted characters. The brightness knob increases or decreases brightness of the entire screen. The portable has only a contrast control.

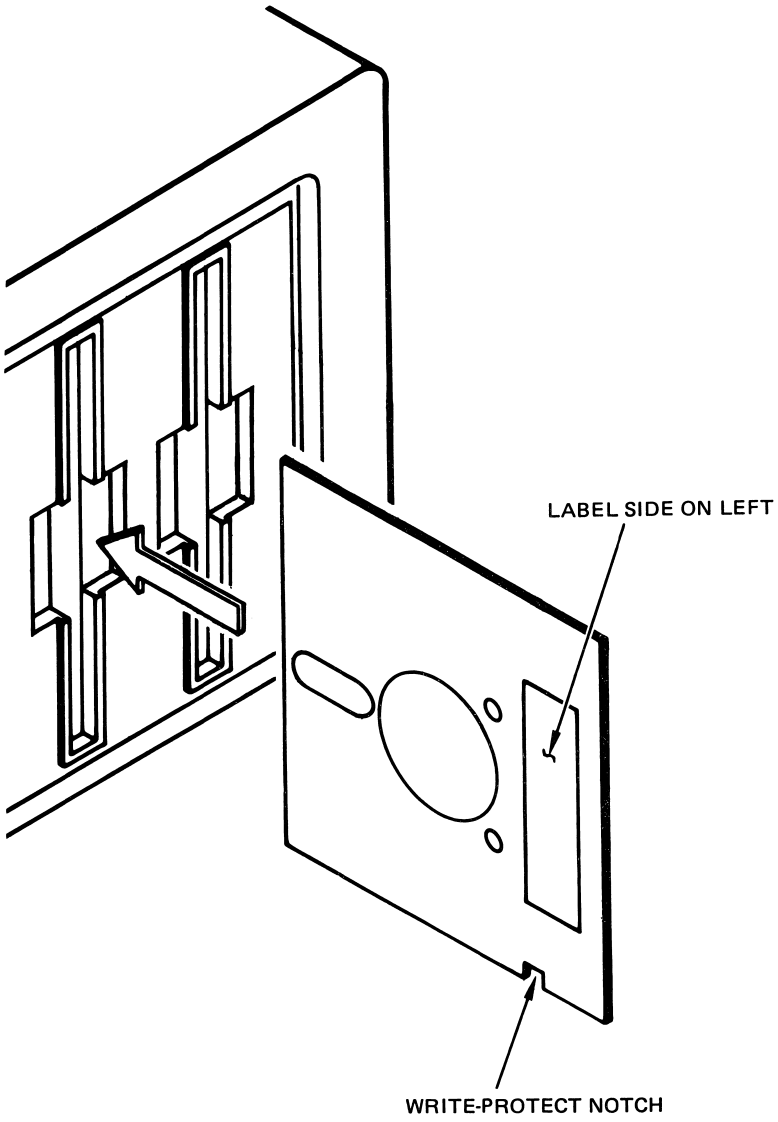

Figure 6-4. Inserting a Diskette in the Portable Drive

Resetting the System

Resetting is rebooting the system without turning it off and on. You will want to reset the system if the keyboard locks up for some reason (power surge, operator error, etc.). There are two ways to reset.

1. Press the reset button located on the back of the system unit. Refer to Figure 5-4 for desktop and Figure 5-6 for portable locations.
2. Press "Ctrl", "Alt", and "Del" keys simultaneously.

Power Off

To turn off the Corona PC, turn off the power switch on the back of the system unit. For location refer to Figure 5-4 on desktop and Figure 5-6 on portable.

It is not imperative that you turn off the monitor on the desktop every time you turn off the computer. (The portable has no monitor switch.)

USING THE KEYBOARD

The keyboard (Figure 6-5) supplied with the Corona PC has ten function keys (located on the far left side), and a number of other special keys.

The function of each key depends on whether you are using DOS or any application program that assigns special functions to the keys. Function keys are "programmable". Please see the DOS 2.0 manual for specific information about these keys.

Keys on the Left of the Keyboard

The Esc, Tab, Ctrl, Shift, and Alt keys are found directly to the left of the white keyboard area.

Esc

Generally used to escape from a routine or a program. Often used in word-processing packages to go from one mode, such as editing, to another, such as command mode.

Tab

This key moves the cursor on the screen a certain number of spaces to the right. In word-processing packages you can vary the number of spaces.

Ctrl

Used with another key to perform a command or function.

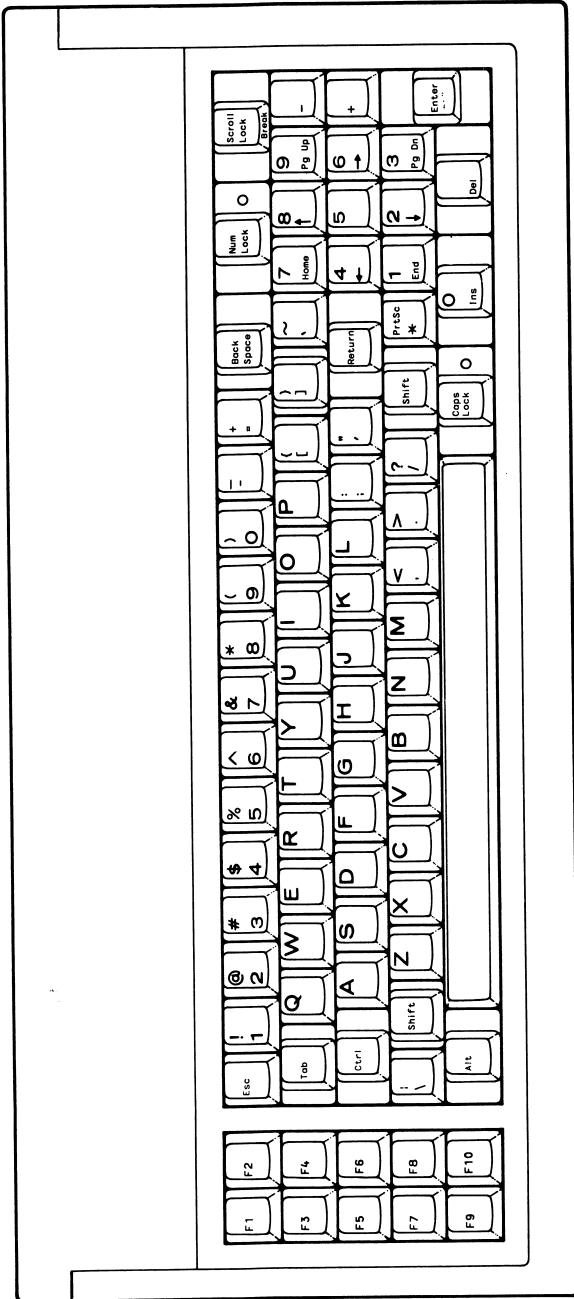

Figure 6-5. The Keyboard

Using the Keyboard

Shift

This key changes lower-case letters to upper-case. If the Caps Lock key is activated, the Shift Key changes upper-case letters to lower-case. If the Num Lock key is activated, the Shift key activates the cursor control function of the 10-key numeric keypad.

There is also a shift key on the right of the main keyboard.

Alt

Used with another key to perform a command or function.

Keys on the Right of the Keyboard

Back
Space

This key moves the cursor one character to the left. Depending on the application, it can also erase the letter over which it moves.

Return

This key moves the cursor from the current line to the beginning of the next line. It is also used to initiate operating system commands.

PrtSc
*

In lower-case this key will display an asterisk (*). In upper-case this key prints what is displayed on the screen (Print Screen).

When pressed with the Ctrl key, it turns on "printer echo". Printer echo sends whatever text data is being displayed on the screen to the printer as it is being entered. To turn off printer echo press Ctrl-N.

Neither print screen nor printer echo will cause graphic information to be printed. To print graphic information you must have a printer with this capability as well as the necessary software.

Caps
Lock

Locks all letter keys to upper case. All other keys are left as lower case. To temporarily type lower-case letters, press one of the shift keys.

Scroll
Lock
Break

Used with the Ctrl key, it stops program execution.

Num
Lock

Activates or deactivates the 10-key numeric keypad.

When activated (the light is on) the numbers on the keypad can be used, and the "+", "-", and "." keys are active.









The Num Lock key also temporarily stops the display on the screen if pressed with the Ctrl key. Press any key to restart the display.

When deactivated (the light is off), the numeric keypad performs certain functions, depending on the operating system or program you are using. For instance:

 = Cursor to top left of screen.

 = Cursor up one line.

Using the Keyboard

-  = Cursor up one page.
-  = Cursor one character left.
-  = Cursor one character right.
-  = Cursor to last character on line.
-  = Cursor one line down.
-  = Cursor one page down.
-  = Enter and exit insert mode.
-  = Delete character at the cursor.

Section 7

DOS 2.xx

DOS stands for Disk Operating System, pronounced D-O-S or "doss" (to rhyme with boss). DOS 2.xx is a collection of programs that provide you with the means to regulate data, to manage the hardware resources of your computer, and to perform special operations.

In this section you will learn how to boot DOS 2.xx. Refer to the DOS 2.0 manual for more explicit information on these and other DOS 2.xx commands and programs.

IMPORTANT

The first thing you should do is create a backup copy of your DOS 2.0 diskette. This is done with the DISKCOPY command. (Refer to DISKCOPY in Section 4 of the DOS 2.0 manual.)

If you use an original diskette and do not have a copy of it, all the programs on the diskette can be lost for any number of reasons. It is standard computer procedure to make a copy of

every original diskette you own. Put the original away in a safe place and use only the copy.

Some application program diskettes are copy-protected, preventing the diskettes from being copied. If so, you will have to work from the original copy of the diskette.

BOOTING WITH DOS. 2.xx

NOTE: You can boot the PC TUTOR diskette in the same manner as the DOS 2.xx diskette.

1. Turn on the monitor (desktop only), and insert the DOS 2.xx diskette in the "boot" drive. The desktop's boot drive is on the top, and the portable's boot drive is on the left.
2. Turn on your system.

If the diskette is inserted incorrectly, or is not bootable, an error message will occur.

After a successful boot, a boot message will be displayed on the screen, followed by a request to enter the date.

Refer to "Resetting the System" in Section 6 for instructions on resetting your system.

ENTERING A NEW DATE

1. Type the date as mm-dd-yy, using slashes, "/" or hyphens "-" between the month (mm), day (dd), and year (yy). Then press the Return key.

Valid dates are: month 1 to 12, day 1 to 31, and year 80 to 99. Examples are 06-01-83 and 12/31/81.

2. If you do not want to enter a date, press Return. You will then be prompted to enter a new time.

ENTERING A NEW TIME

Type the time as hh:mm, using a colon ":" between the hour (hh) and minute (mm). Then press Return.

Valid times are: hour 0 to 23, and minute 0 to 59. Examples are: 9:05 and 21:46.

If you do not want to enter a time, press Return.

The screen will then display the DOS system prompt, "A>".

When you see the A> prompt, you will know you are in DOS on drive A, and at command level (ready to type a system command).

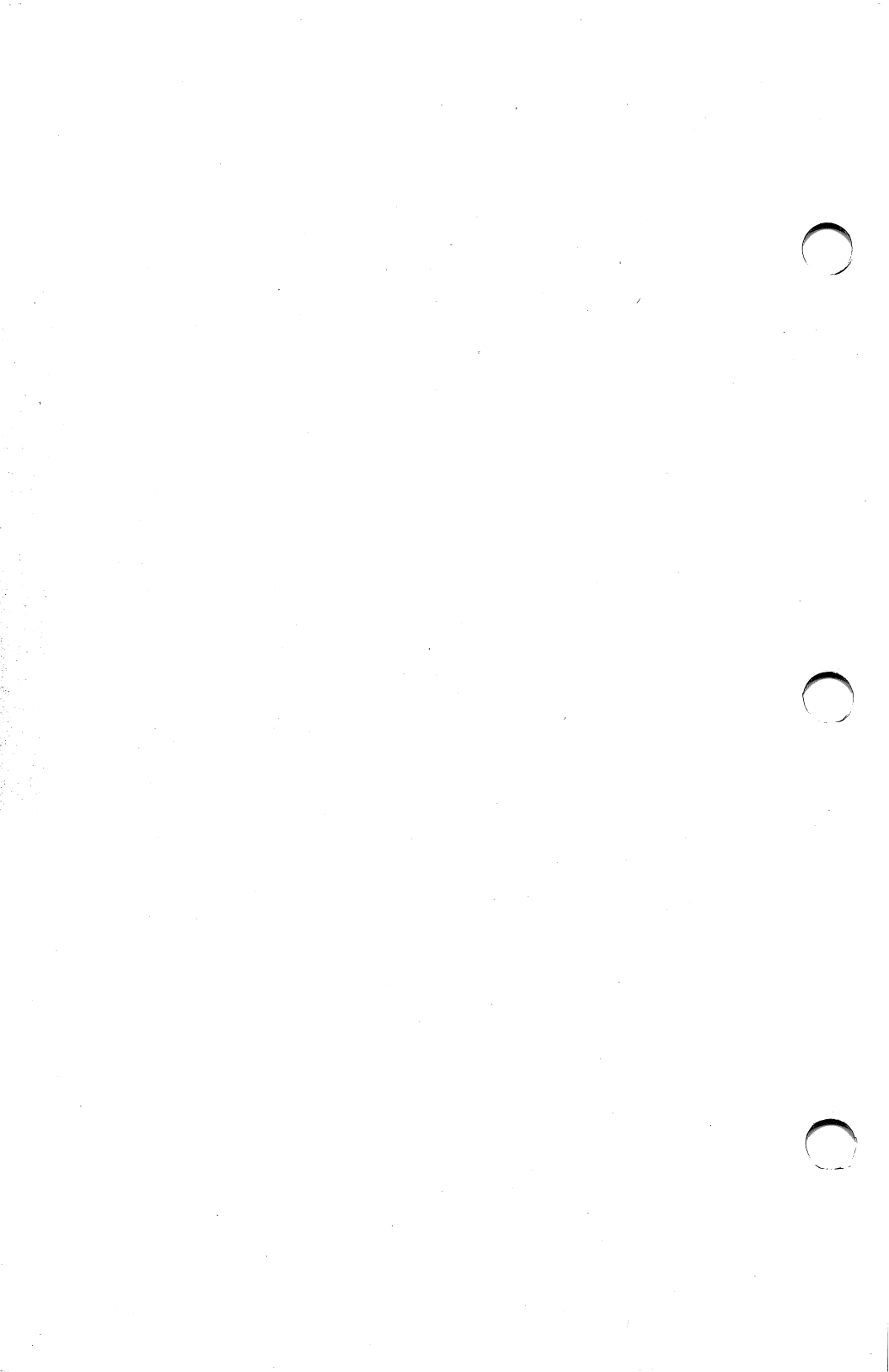

Appendix A

CONNECTOR PIN ASSIGNMENTS

The following are the printer connector pin assignments for the two 25-pin DB-25 connectors found on the back of the system unit.

On the desktop the connector nearest the reset button is a parallel port, and the connector nearest the video connector is a serial port. Refer to Figure 5-6 for connector locations on the portable.

The serial port can be used as a printer port by installing the jumper platform in J5 for the desktop or J8 for the portable, or it can be used as a communications port by installing the jumper platform in J6 for the desktop or J7 for the portable.

For further information on the serial port see Section 5 of this manual.

PARALLEL PORT

CONNECTOR PIN ASSIGNMENTS AND DESCRIPTION

Pin assignments refer to J9 on the desktop or J1 on the portable.

"Dir." refers to the direction of signal flow as viewed from the printer.

For pin assignments at the printer end of the cable, please refer to your printer manual.

Pin #	Signal	Dir.	Description
1	STROBE	In	STROBE pulse to read data in. Pulse width must be more than 0.5 μ s at receiving terminal. The signal is active low.
2	DATA 0	In	
3	DATA 1	In	These signals represent information about 1st through 8th bits, respectively, of parallel data.
4	DATA 2	In	
5	DATA 3	In	
6	DATA 4	In	The high level is logical "1".

APPENDICES

PARALLEL PORT

CONNECTOR PIN ASSIGNMENTS AND DESCRIPTION
(Cont.)

Pin #	Signal	Dir.	Description
7	DATA 5	In	
8	DATA 6	In	
9	DATA 7	In	
10	ACKNLG	Out	Approximate 5 μ s pulse. "LOW" indicates data has been received, and the printer is ready to accept more data.
11	BUSY	Out	"HIGH" indicates the printer cannot receive data. The signal becomes "HIGH" in the following cases: <ol style="list-style-type: none">1. During data entry2. During printing3. In OFF-LINE state4. During printer error status

PARALLEL PORT

CONNECTOR PIN ASSIGNMENTS AND DESCRIPTION (Cont.)

Pin #	Signal	Dir.	Description
12	PEND	Out	"HIGH" indicates the printer is out of paper.
13	SELECT	Out	Indicates the printer is selected.
14	AUTO FEED	In	When "LOW", paper is automatically fed one line after printing.
15	ERROR	Out	Signal becomes "LOW" when the printer is in: <ol style="list-style-type: none">1. PAPER END state2. OFF-LINE state3. ERROR state

PARALLEL PORT

CONNECTOR PIN ASSIGNMENTS AND DESCRIPTION
(Cont.)

Pin #	Signal	Dir.	Description
16	INITIALIZE PRINTER	In	When "LOW", the printer controller is reset to its initial state, and the printer buffer is cleared. This signal is normally "HIGH", and its pulse width must be more than 50 μ s at the received terminal.
17	SELECT INPUT	In	Data entry to the printer is possible only when this signal is "LOW".
18-25	GROUND		

SERIAL PORT

CONNECTOR PIN ASSIGNMENTS AND DESCRIPTION

Pin assignments refer to J8 on the desktop or J2 on the portable.

Data Terminal Equipment device or DTE (serial printer) and Data Communications Equipment device or DCE (modem) indicate that the computer has been set up to control a printer or communications equipment. The particular configuration is controlled by the location of the serial port jumper. Refer to Section 5 for details.

"In" means input to computer.

"Out" means output from the computer.

DTE Pin #	DCE Pin #	Signal Direction	Signal	Description
3	2	Out	TXD (Transmit Data)	Data trans- mission line from computer to external device
2	3	In	RXD (Receive Data)	Data trans- mission line from external device to computer

APPENDICES

SERIAL PORT

CONNECTOR PIN ASSIGNMENTS AND DESCRIPTION
(Cont.)

DTE Pin #	DCE Pin #	Signal Direction	Signal	Description
5	4	Out	RTS (Request to Send)	Informs external device that computer is ready to transmit data
4	5	In	CTS (Clear to Send)	Indicates a ready signal from an external device to the computer
20	6	In	DSR (Data Set Ready)	External device ready to transmit data to computer

SERIAL PORT

CONNECTOR PIN ASSIGNMENTS AND DESCRIPTION
(Cont.)

DTE Pin #	DCE Pin #	Signal Direction	Signal	Description
7	7	In/Out	SG (Signal Ground)	Ground reference for all data and control signals
8	8	In	RLSD (Carrier Detector)	Modem is receiving signal
6	20	Out	DTR (Data Terminal Ready)	Indicates computer is ready to communicate to external device
22	22	In	RI (Ring Indicator)	Signals incoming call

APPENDICES

Appendix B

SPECIFICATIONS

PROCESSOR	16-bit 8088
MEMORY	256K expandable to 512K
DESKTOP STORAGE TYPE	Either: <ol style="list-style-type: none">1. Two half-height double-sided, double-density diskette drives and one 10MB hard drive.2. One double-sided, double-density diskette drive and one 10MB hard drive.3. Two double-sided, double-density diskette drives.
PORTABLE STORAGE TYPE	Either: <ol style="list-style-type: none">1. One half-height double-sided, double-density diskette drive and one half-height 10MB hard drive.2. Two half-height double-sided, double density diskette drives.

Appendix B

DESKTOP MONITOR SIZE	H = 11.26 in. D = 13.09 in. W = 13.41 in.
DESKTOP MONITOR WEIGHT	18 lbs
PORTABLE SIZE	H = 9.6 in. D = 19.8 in. W = 18.8 in.
PORTABLE WEIGHT	38 lbs (double diskette drive)
DESKTOP SYSTEM UNIT SIZE	H = 6.33 in. D = 17 in. W = 19.5 in.
DESKTOP SYSTEM UNIT WEIGHT	32 lbs
KEYBOARD SIZE	H = 1.4 in. L = 17.75 in. W = 7.6 in.
KEYBOARD WEIGHT	5.5 lbs
KEYBOARD CABLE LENGTH	6 ft (when stretched)
TEMPERATURE	Operating - 10°C to 44°C (50°F to 104°F) Non operating - 0°C to 60°C (32°F to 140°F)

RELATIVE HUMIDITY	Operating - 8% to 80% (noncondensing) Non operating - 5% to 95% (noncondensing)
COMMUNICATIONS PORT	One RS-232C serial
PRINTER PORT	One Centronics-compatible parallel
EXPANSION SLOTS	Four IBM PC-compatible slots
POWER SUPPLY	110 watt switching supply
HARD DISK CONTROLLER	IBM XT compatible (uses one expansion slot) hard drive system only
ALPHANUMERIC DISPLAY	80 columns, 25 rows
CHARACTER FONT	16 X 16 dots
CHARACTER ATTRIBUTES	Reverse video, underline, blinking, high intensity
GRAPHICS RESOLUTION	640 x 400 pixels
TEXT WITH GRAPHICS	Text can overlay graphics

STANDARD SOFTWARE

OPERATING SYSTEM DOS 2.xx

OPTIONAL SOFTWARE PACKAGES

Accounting
Communications
Data Base Management
Graphics
Integrated Systems
Modular Systems
Operating Systems
Personal Productivity
Programming Languages
Spreadsheets
Training
Utilities
Vertical Market Applications
Word Processing

NOTE: GWBASIC (a programming language) and MultiMate (a word processing program) may be bundled with your PC.

Appendix C

MAINTENANCE

CLEANING YOUR COMPUTER

NOTE: Clean your computer only when necessary, and make sure the power to the system is off.

1. **Cleaning the diskette drive heads:**

Use any commercial head cleaner that can be purchased at a computer store. The directions that come with the kit should explain how often the procedure should be done.

2. **Cleaning the system monitor:**

Use water and a mild detergent with a non-abrasive cloth.

3. **Cleaning the system unit:**

Use a slightly damp cloth with a mild detergent. Do not drip water inside the system unit.

4. **Cleaning the keyboard:**

Use a barely damp cloth with a mild detergent. Do not let water drip into the spaces between the keys.

HELPFUL HINTS AND ERROR MESSAGES

- A change in climate will affect the operation of your computer. A diskette left in a cold car should be allowed to warm to room temperature before using. If you have a hard drive, you should wait an hour for each 10°C of temperature change before using the drive.
- Do not connect or disconnect the keyboard when your system is on. Doing so may damage the operation of your keyboard, therefore creating unnecessary problems with your system.
- During the boot up process, a "self-check" test is performed on various internal areas of your computer. Failures during these tests will appear as one of the following flashing characters in the upper left corner of the screen: "T", "D", "I", "K".

If "T", "D", or "I" appears, you should call your dealer for help. If "K" appears, that usually means the keyboard is not connected. Turn off the power, and then check both keyboard connectors to make sure they are secure. If, after you have checked, "K" still flashes on the screen, call your dealer for help.

- During the boot up process, if you have a hard drive, and the message "1701" appears on your screen, this means that the hard drive is not being recognized because of a hardware problem.

The cables between the hard drive and its controller card may not be connected properly. Turn off the power and refer to Section 5 of this manual for instructions on removing the system cover. Check to see that the cables are connected securely, and then power on and boot the DOS 2.xx diskette again. If the "1701" error message is still present, call your dealer for help.

BEFORE CALLING ANYONE WITH PROBLEMS

If you have a problem, use the checklist below to eliminate some obvious errors.

Power on problems:

- Is your system plugged in?
- Is there power at the wall socket?
- Are all the cables connected, and are they in the right place?
- Are the monitor controls adjusted properly?
- Is the configuration switch set correctly?
(Switch settings are explained in Section 5.)

Booting and diskette failure:

- ___ Is your diskette a bootable one?

- ___ Have you tried using another diskette?

- ___ How old is the diskette you are using?
(Diskettes do not last forever.)

- ___ Is the diskette you are trying to write to
(with a FORMAT, COPY, DISKCOPY, etc.,
command) write-protected? You must remove
the write-protect tab.

Hard drive problems:

- ___ Did you use the right sequence to
initialize your hard drive (PHDINIT, FDISK,
and FORMAT /S)?

- ___ Did you copy files to the hard disk
correctly, especially the DOS commands?

- ___ Are you accessing the hard drive through
its correct system prompt? This would
normally be the C> prompt.

Printer and communication problems:

- ___ Is the peripheral device turned on?

- ___ Is the cable you are using the correct type?

- ___ Is the peripheral device displaying any failure indications?

- ___ Did you carefully read all the documentation that came with the peripheral?

- ___ Did you perform the MODE command sequences described in the DOS 2.0 manual correctly? This must be done for both printers and communication devices.

- ___ Is the peripheral connected to the proper port?

- ___ Is the jumper plug installed in the correct spot (DTE or DCE)? Refer to Appendix A.

If your problem still has not been resolved, try to repeat it. Take notes on the sequence you used and WHAT HAPPENED AT EACH STEP. THEN ASK YOUR DEALER FOR HELP.

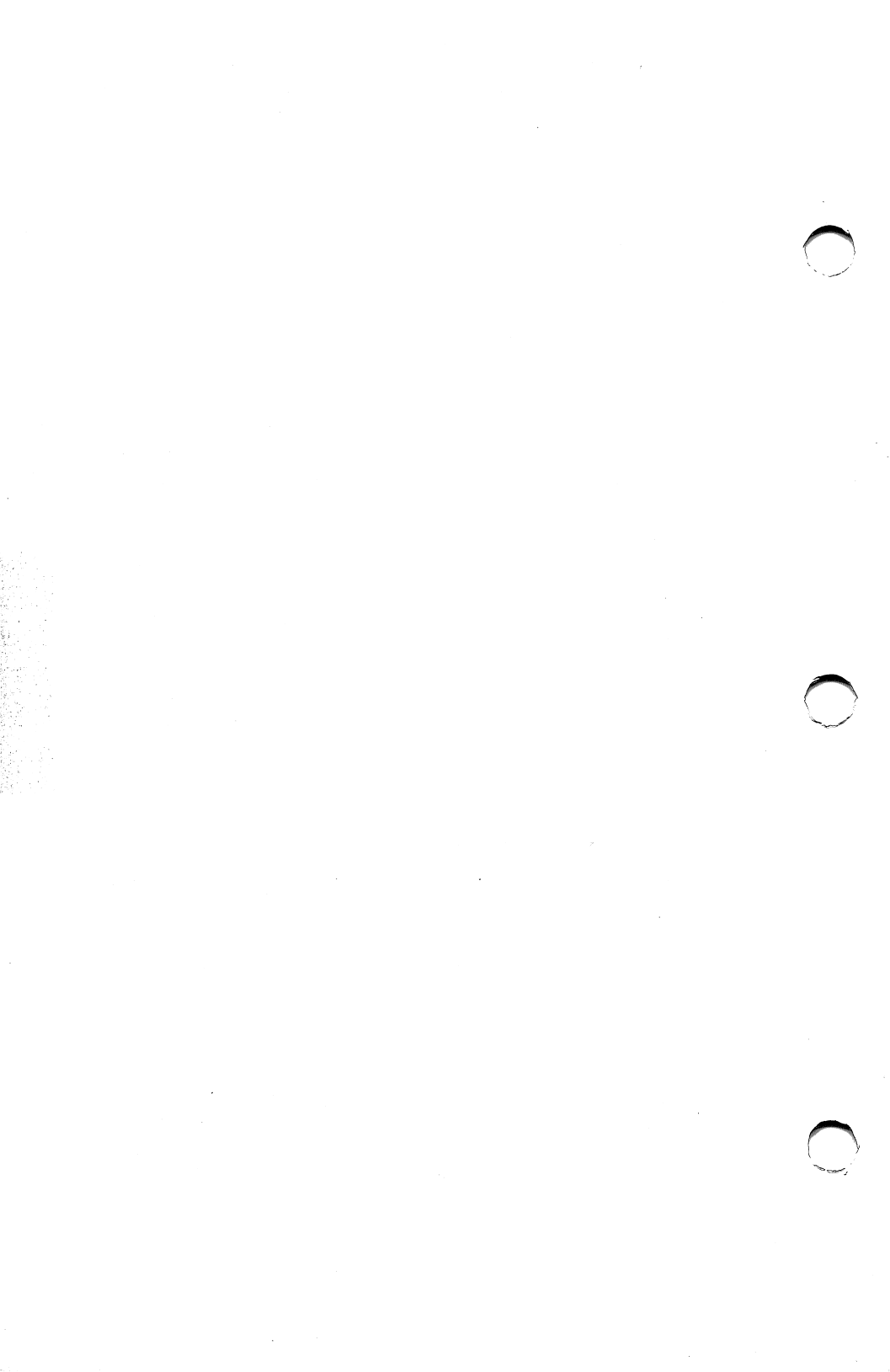

Appendix D

CARE AND HANDLING OF THE HARD DRIVE

This microcomputer's hard drive uses "Winchester" technology. The read/write heads fly 20 millionths of an inch above the disk surface. The hard drive is in a sealed enclosure, and has a 0.3 micron (0.3×10^8) filter to keep the air in the enclosure clean.

A hard drive is a precision engineered device and is very delicate. Please use care when handling the hard drive; rough and improper handling account for more damage to hard drives than all other factors combined. (The hard drive is also expensive to replace, so be careful!)

Winchester drives have a proven Mean Time Between Failure (MTBF) in excess of 11,000 hours. They are not expected to fail more than once in over five years of operation (assuming 40 hours per week of power-on time). If you mishandle your hard drive, you will reduce the MTBF.

1. Do not subject the drive to forces in excess of 20Gs.

Do not drop your hard drive at all! If you drop the hard drive onto a hard surface from a height of even one inch, the read/write

heads might lift up and bounce back down on the disk media (surface). If this happens, the media could get scratched, and there would be a permanent media defect at that spot, causing read/write errors.

2. Do not move the hard drive while running or during spin down.

After power to the hard drive has been turned off, it takes approximately 30 seconds for the drive to slow down and the read/write heads to settle properly. If you jolt or jar the hard drive during this power-down cycle, the read/write heads might skid or "crash" into the surface of the drive. This "head crash" can result in permanent read/write errors.

3. Do not allow the ambient (air) temperature to vary more than 10 degrees centigrade (18 degrees Fahrenheit) per hour while the hard disk is in use.

If you take your hard drive from a cold environment to a warm environment (or vice versa); or if you let the computer room heat up or cool down at night; let the hard drive adjust to the new temperature for 30 minutes before using it. There are several mechanical assemblies responsible for keeping the read/write heads positioned properly, and each of these assemblies has a different thermal expansion rate. If you attempt to use the hard drive before all

these assemblies have adjusted to the new temperature, you might get read/write errors.

4. Do not rotate the spindle or track zero interrupter.

These items are located on the hard drive inside the system unit of your computer. Do not touch any moving parts on the hard drive. It is expensive to replace.

5. Reposition the read/write heads before moving the drive.

When a hard drive is powered down, the read/write heads sit directly on the surface. If you move the hard drive without repositioning the read/write heads, they might skid across the surface of the drive and damage the media.

Move the read/write heads with the PARK command before moving the hard drive. Refer to "PARK" in Section 4 in the DOS 2.0 manual for instructions on how to do this.

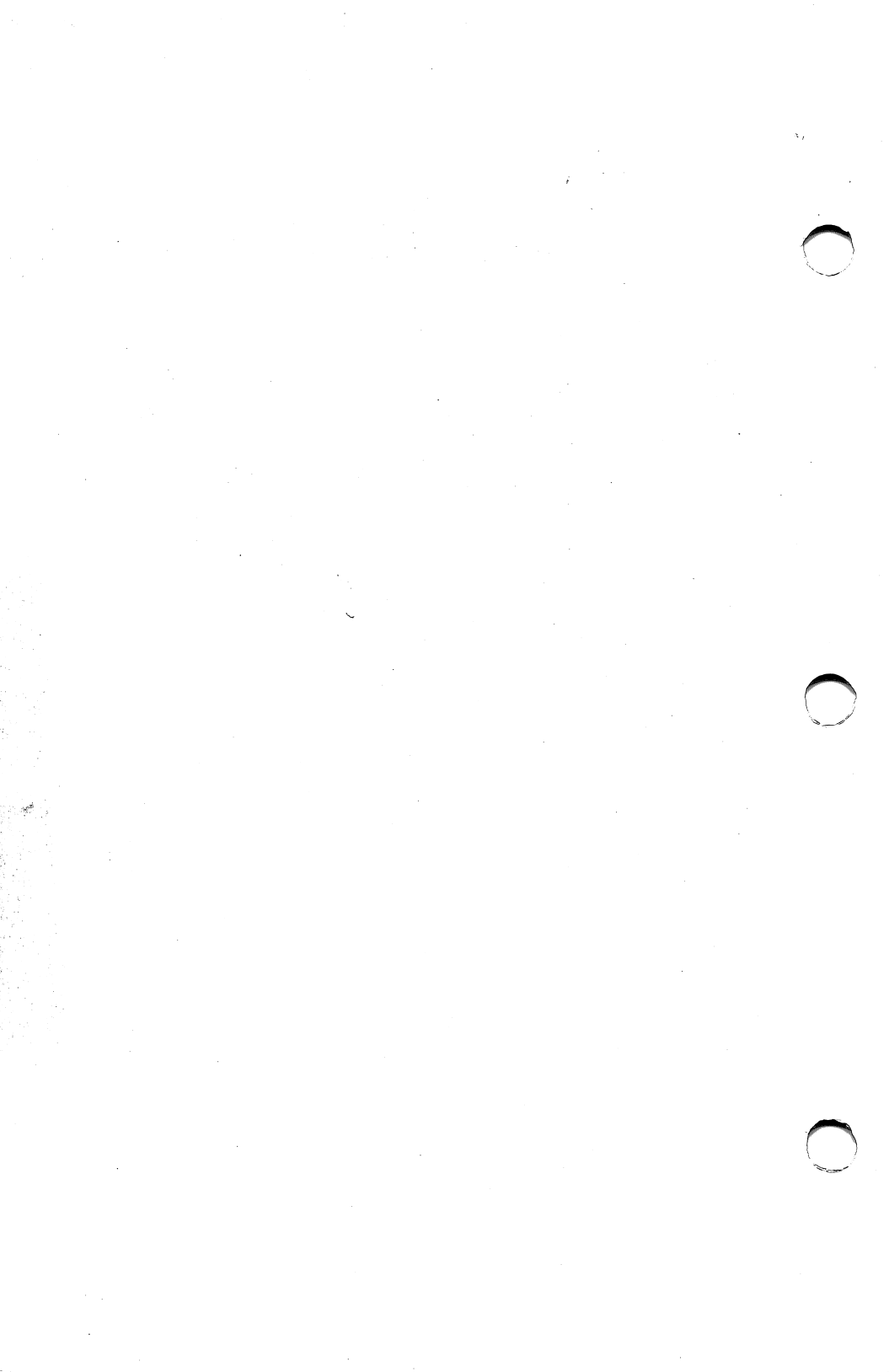

GLOSSARY

ACK. Acknowledgement. A signal sent from one system to another to acknowledge that it is ready to begin transmission. See ENQ, Handshaking, NAK.

Acoustic Coupler. A device used with a standard telephone handset to convert digital signals output by the computer via the RS-232C serial interface into acoustic frequencies for transmission over standard telephone lines. On the receiving end, the acoustic coupler converts acoustic frequencies into data signals for input to the computer via the RS-232C serial interface.

Answer Mode. The condition of being ready to receive incoming data. See originate mode.

Alphanumeric. A combination of letters of the alphabet and numbers.

Application Program. A program written for a specific use (application), such as an accounting package.

ASCII. Acronym for American Standard Code for Information Interchange. (Pronounced "Askey".) This is the standard 8-bit information code used with most computers.

Glossary

Asynchronous. Lacking regular time relationship. As applied to terminal communications, asynchronous refers to the method of transmitting data. It is not necessary for a steady stream of data to be transmitted at regular time intervals between each group of bits. Asynchronous data communications rely on the system's ability to detect the beginning of a group by a change in frequency. See FSK.

Auto Linefeed. A linefeed that is automatically appended to a carriage return, placing the cursor at the beginning of the next line, thus avoiding the overtyping of existing characters.

Batch Job. A group of records or documents considered as a single unit for the purpose of processing.

Baud or Baud Rate. Transmission speed measured in terms of the number of frequency changes per second. The most common baud rates are 110, 300, 1200, 4800 and 9600. A typical pattern for data transmission is 1 start bit, 1 stop bit and 7 data bits to make up a word. Therefore, at 300 baud, approximately 33 characters are transmitted per second.

BBS. Bulletin Board System. A program operating on a host computer, providing a base for Electronic Mail and public information exchange.

Bell 103A. Modem specifications provided by Bell Systems which provide for two narrow bands of frequencies, each of which sends messages in

one direction only. Two channels are thus available over one telephone line by means of FSK modulation. See FSK.

Bezel. The front piece on the system unit.

Bit. The smallest piece of information used by a computer. A bit is either true ("on" or "1") or false ("off" or "0"). Corona PCs are 16-bit computers; the internal registers they use each have 16 bits.

Boot, Boot-up. To automatically take a program from a disk or diskette, load it into memory and run it. The program in this case is almost always the disk operating system (DOS).

Boot Drive. The diskette or hard drive that attempts to boot when the computer is turned on or reset.

Bootable Diskette. A diskette with an operating system on it.

b.p.s. Bits per second. The baud rate is calculated in the number of bits it transmits each second. Thus, 1200 baud indicates 1200 bits are being transmitted each second.

Buffer. A temporary storage area in memory to hold data, usually for input or output.

Captive Screws. Screws that are a permanent part of a connector and are used to secure it when it is plugged in. The screws remain attached to the connector even when the

connector is not in use, and are kept from falling out of the connector by the use of various restraining devices.

Carrier. A signal composed of mixed frequency and amplitude. The modem modulates the tones according to the signals sent from the computer to the telephone, and demodulates incoming signals from the telephone to the computer.

Centronics. A style of parallel port using certain known conventions. If you attach a device to a Centronics-type parallel port, the device must use Centronics protocol.

Code Conversion. Changing of codes from binary to ASCII, or from ASCII to binary.

Command Level. You are at command level when a system prompt is displayed on the screen. This means the system is ready for you to type in a command.

Command Lines. Operating system instructions (commands) following a system prompt.

Compiled. A program that has been permanently converted into machine code. Machine code is composed entirely of "1"s and "0"s, and is the only code a computer can read by itself.

Connect Time. Total time spent on host system, measured from signon to signoff, or logon to logoff. Timesharing systems calculate charges based on connect time.

Control Character. A character whose occurrence in a particular format initiates, modifies, or stops a control function.

Copy Protected. A program, or diskette that has been modified so that it cannot be copied. Copy protection is usually used as a means of preventing unauthorized copying and/or sales of application programs.

CPS. Characters per second.

Cursor. A visual marker that tells you where you are on the video screen. The cursor is used extensively in application packages such as word processing. It can be moved around on the screen by using the arrow keys, and various other keys, depending on the program being run.

Data Communication. The technology of transmitting data between computers, often with one host computer and numerous remote terminals, frequently between two microcomputers. Signals are transferred by hard-wire connections, telephone lines, or satellites.

Dedicated Line. A line committed to or set aside for one specific use.

Default. A value assigned automatically if no other is specified. Default values are frequently used by operating systems. For instance, unless you specify that a program you want is on another drive, the computer assumes the program is on the default drive, the drive you are currently using.

Demodulator. The function of a modem which converts incoming signals composed of mixed frequencies and amplitudes to the original digital signals sent by the other computer.

DIP Switch. Acronym for Dual In-line Package. A small component containing a row of switches, each of which can either be on or off. The pattern of on's and off's tells the computer whether certain hardware is attached to it.

Diskette Drive Controller The component inside the computer that controls the diskette drive(s).

DMA. Acronym for Direct Memory Access. A device used to accelerate memory transfers. It is also used to "refresh" memory and to accelerate diskette transfers.

DOS. Acronym for Disk Operating System. The set of programs on a diskette or hard drive made up especially for a particular system and that provides the system with its operating capabilities.

Duplex. See Full Duplex, Half Duplex.

Dynamic Memory. Temporary memory, which must be periodically accessed (refreshed) to remain accurate. Special hardware is used to ensure the integrity of the dynamic memory by constantly accessing it. When power is removed from dynamic memory, it is erased.

Electromagnetic Device. A device such as a relay or transformer, that operates on electrical and magnetic energy.

Electromechanical Device. A device, such as an electronic typewriter, that is run by electrical impulses and mechanical movement.

ENQ. A signal is sent to the transmitting computer to indicate that the receiver is ready to receive another sector of data. The ACK signal is the response by the transmitting computer. This series of signals is known as handshaking and is a method of preventing one computer from getting ahead of the other.

EOF. End of File. A signal indicating that the file being transmitted has reached the end. The receiving computer then sends the remote station an acknowledgement that it has received the end of the file.

Error Condition. A contradictory or incorrect instruction issued to a computer, causing the computer to have to stop because it cannot resolve the contradiction or error. For instance, telling the computer to display a directory of all the files on the diskette in drive B will cause an error condition if there is no diskette in drive B, or if there is no drive B. An advisory error message usually displays when an error occurs.

FSK. Frequency Shift Keying. A form of frequency modulation that shifts the signals output by the RS-232C interface between two predetermined frequencies, rather than simple ON

Glossary

and OFF states. The term originated with the radioteletypewriter method of transmitting data (RTTY).

Full Duplex. A communication mode that permits the transmission of data in two directions simultaneously over the same line. In full duplex mode, characters are sent to the remote computer, which echos back to the sender what was received: this echo is then displayed on the screen. Simultaneous transmission is accomplished by utilizing two narrow frequency bands of the carrier.

Function Compatible. The same action performs the same function on two different devices. The Corona PC has an IBM function-compatible keyboard. This means that the keys on the Corona PC keyboard perform the same functions as the keys on the IBM PC keyboard. (See Off-the-Shelf).

Glitch. A pulse or burst of noise or other nuisance item that becomes an annoyance and causes errors or failures.

Half Duplex. A communication mode that can carry transmission of data in either direction, but limits it to one direction at any given moment. In half duplex, all characters entered at the keyboard are sent directly to the display as well as to the modem.

Handshaking. A system of signals sent and received between two terminals, assuring that each one is working in harmony with the other. See ACK, ENQ and NAK.

Hardware. The physical equipment that makes up the computer.

Hardwired. A device internally attached to a computer that becomes a part of it. It can either be soldered on a board or plugged into an expansion slot.

Hexadecimal or Hex. Base 16 number system. Because there are no numerals higher than 9, hexadecimal uses the letters A through F as symbols for the numbers 10 through 15.

High or Low Intensity. The two levels of brightness in which shapes, characters, and lines may be displayed on the video screen.

High-Resolution Graphics. Very detailed shapes, characters and shades displayed on the video screen.

Internal Memory. The internal parts of a computer capable of retaining data.

Jumper Area. A section on a computer board that has several points of contact. Changing these points of contact changes the flow of information in the computer.

Light Pen. A pen-like device used by some application programs. A light pen is connected to the computer through a long cable. Touching the light pen to the video screen would allow you to move, point to, select, or draw something on the screen, depending on the application program.

Glossary

Link. The process that unites a subprogram to the main program.

Logon, Logoff. Making connection with the host computer is known as logging on, and the time during which the host recognizes the remote terminal is known as the logon time. Charges are billed based on the actual connect time between logon and logoff, when the connection is terminated.

Memory. An area the computer uses to store data and/or the program it is using. A computer takes a program from a hard drive or diskette and loads it into its memory. Only after the program is in memory can the computer use it.

Modem. A device that allows one computer to communicate with another computer via telephone lines.

NAK. Negative acknowledgement. A signal sent to the remote computer indicating that the transmitting computer is not yet ready to transmit. This is the opposite of ENQ. See ACK, ENQ, Handshaking.

Null. A dummy signal used to fill time or space.

Number Crunching. Slang for arithmetic operations.

Off-the-Shelf. Pertains to the hardware or software that can be purchased in ready-to-use form from a dealer.

Operating System. See DOS.

Originate Mode. One combination of the two pairs of frequencies used for sending and receiving data communications. In the originate mode, the modem transmits a 2025-Hz tone to represent a 0, and a 2225-Hz tone to represent a 1. It receives signals at 1070 Hz representing a 0, and 1270 Hz for a 1. These frequencies are reversed in the answer mode.

Parameter. An addition to a command. A parameter modifies the command by telling it to perform an additional function.

Parity. The sum of bits in a character. If the sum is always even, then parity is said to be even. If the sum is odd, then parity is odd. If no distinction is to be made between even or odd sums, parity is none.

Parity Bit. A bit transmitted at the end of a character, and used by the receiving computer to assist in determining whether or not an accurate transmission was received.

Peripheral. Any device connected to the computer and dependent on the computer for its operational instructions, such as a printer or a modem.

Pixel (Picture Element). One of the tiny dots that makes up the characters or graphics displayed on the monitor screen. The more pixels there are per character, the finer the detail (higher resolution).

Port. A door between the computer and another device, such as a printer or a modem. Data travels back and forth between the computer and other devices through ports that are built into the computer. The Corona PC has a 25-pin serial port and a 25-pin parallel port visible on the back of the system unit. Not all ports are accessible; some of them are incorporated into the main board.

Prompt. The system initiates a question and awaits operator's response. (See System Prompt.)

RAM. Acronym for Random Access Memory. This is temporary internal memory that can be both read from and written to. As soon as the system is rebooted or turned off, the data that was in RAM is gone.

Refresh Rate. The speed at which both dynamic memory and the video screen are rewritten. Both have to be rewritten (refreshed) to remain accurate. In the Corona PC, this happens at such a fast rate that it is not detectable.

Reverse Video. Dark characters on a light background. Normal video has light characters on a dark background.

ROM. Acronym for Read Only Memory. This is permanently stored memory inside a computer that contains instructions on how to access the drives, video screen, ports, etc. It does not erase when the power is turned off. ROM cannot be written to, only read from.

RS-232C. A style of serial port using certain known conventions defined by the EIA (Electronic Industries Association).

Scrolling. Advancing the display on the video screen so that new lines constantly come into view and old ones disappear. You can scroll toward the bottom of a file (so that you can read the file in a normal top to bottom manner), or you can scroll backwards toward the top of a file.

Serial Interface. The connection which permits data transmission serially or sequentially, carrying one bit at a time, as opposed to a parallel interface which transmits groups of bits simultaneously over several lines.

Software. Instructions that are read and used by the system, enabling it to perform desired functions.

Spooling. The capability of storing data in a special buffer to allow the printer to operate at its own speed.

Start Bit. The bit transmitted immediately prior to the group of data bits to assist in synchronization and verification of serial data. Most systems utilize zeros for start bits.

Static Memory. Memory that does not have to be refreshed. Both ROM and drives constitute static memory.

Glossary

Stop Bit. The bit transmitted immediately after the group of data bits to assist in synchronization and verification of serial data.

Surge Protector. An electrical device that minimizes fluctuations in the electrical power.

Syntax. A model to indicate required and optional characters needed to enter a command instruction from the keyboard. Corona refers to syntax as "format".

System Prompt. A character such as "A>", indicating that you are using an operating system. Commands to an operating system are typed after the system prompt. (See Prompt.)

Transfer of Files. Transmission of text or data files from one computer to another.

Transmission Frequency. When communicating over telephone lines, the two narrow bands within the analog carrier provide the means for data transmission. See originate mode.

UART. Abbreviation for Universal Asynchronous Receiver Transmitter. Hardware device used to convert serial data to parallel and vice-versa.

Utility Programs. Programs that perform system-related rather than data-related functions (e.g., copy and format disks, configure ports, etc.)

Word Processing. Operations include information retrieval, management of information, text editing, typesetting, etc.

INDEX

8087 3-1
 Installation 5-29

A

A> prompt 7-3
About hard drives and diskettes 6-1
Additional information 1-5
Alphanumerics 2-3
 and graphics combined 2-4
Arithmetic 3-1

B

Backup diskettes 7-1
Before installation 5-1, 5-3
Blinking or nonblinking 2-4
Booting 6-8, 7-2
Brightness and contrast control 6-9
Bytes 6-1, 6-2

C

Captive screws 5-9, 5-33
Care and handling of the hard drive D-1
Centronics 3-1
Cleaning your computer C-1
Color board 5-27
Color graphics 3-1

- Color monitor 5-27
- Compatibility 4-2
- Connecting keyboard 5-4
- Connecting monitor 5-6
- Connecting power 5-10
- Connecting system components 5-3
- Connector pin assignments A-1
- Connectors
 - DC power 5-28
 - Diskette drive 5-28
 - Keyboard 5-28
 - Other 5-27
 - Ports 5-22
 - Speaker 5-27
- Contrast and brightness control 6-9
- Co-processors 3-1, 5-29
- Copy-protected 7-2

D

- Date entry 7-3
- DC power connector 5-28
- Description of product 1-2
- DIP switch 5-24
- Diskettes
 - Backups 7-1
 - Care and handling 6-7
 - Differences from hard disk 6-4
 - DOS 2.0 7-1
 - General information 6-1
 - Initialization 1-5, 5-32
 - Inserting in drive 6-8
 - Reading and writing to 6-4
 - Write protect 6-5
 - Booting with 7-2

Entering date 7-3
 Entering time 7-3
Diskette drives
 Connector 5-28
 Head protectors 5-11
DOS 2.xx 4-1, 7-1
 Booting with 7-2
 Entering date 7-3
 Entering time 7-3

E

Expansion slots 5-19

F

Features of the system 1-1

G

Glossary G-1
Graphics 2-4, 5-27
 and alphanumerics combined 2-4
Grayscale 5-27

H

Hard drives
 Care and handling D-1
 Differences from diskettes 6-4
 General information 6-1
 Initialization 1-5, 5-32
 Reading and writing to 6-4

Hardware capabilities and features 2-1
Hardware options 3-1
Head protectors 5-11
Horizontal hold 6-6
How information is recorded 6-2
How to use this guide 1-3

I

Initialization

Diskettes 1-5, 5-22

Hard drive 1-5, 5-32

Inspecting the computer site 5-1

Installation 5-1

8087 5-29

Before installation 5-1, 5-3

Co-processor 5-29

Interface cards 5-19

Keyboard 5-4

Main board 5-11

Monitor 5-6

Ports 5-22

Power 5-10

Printers 3-2, A-1

Relocating the PC 5-32

System components 5-3

Tools you will need 5-3

Intensity, high or low 2-3

Interface cards 3-1

Installation 5-19

Introduction 1-1

J

Jumper areas 5-23, 5-27, A-1

K

Keyboard

- Connecting 5-4
- Connector 5-28
- Description 2-5
- Removing cable 5-34
- Use 6-12

M

- Magnetics 5-1
- Main board 5-11
- Maintenance C-1
- Monitor 2-1
 - Connecting 5-6
 - Disconnecting 5-33

N

- Nonblinking or blinking 2-3
- Normal or reverse video 2-3

O

- Operating system 4-1, 7-1
- Operation 6-1
 - About hard drives and diskettes 6-1
 - Care and handling of diskettes 6-7

- Differences between hard drives and diskettes 6-4
- How information is recorded 6-2
- Inserting diskettes in drives 6-8
- Keyboard 6-12
- Power off 6-11
- Power on 6-8
- Reading and writing to hard drives and diskettes 6-4
- Relocating the system 5-32
- Resetting the system 6-11
- Using the computer 6-8
- Write-protecting a diskette 6-5

Other documentation 1-5

P

- Parallel printers 3-1
 - Pin assignments A-2
- PC TUTOR 1-2, 1-5, 4-1, 7-2
- Pin 1 location 5-29, 5-30, 5-31
- Pin assignments A-1
 - Parallel printer A-2
 - Serial printer A-6
- Pixel characters 2-3
- Ports 5-22, A-1
- Power
 - Connecting 5-10
 - Off 6-11
 - On 6-8
- Printers 3-1, A-1
- Printing 3-1
- Product description 1-2
- Programmable function keys 6-12

R

- Rebooting the system 6-11
- Refresh rate 2-4
- Relocating the system 5-32
- Resetting the system 6-11
- Return key 6-14
- Reverse or normal video 2-3

S

- Sectors 6-2
- Serial printers 3-1
 - Pin assignments A-6
- Signal descriptions A-2, A-6
- Software capabilities and features 4-1
- Speaker connector 5-27
- Specifications B-1
- Static 5-1
- Super resolution graphics 2-4
- Surge protector 5-1
- Switch settings 5-24
- Switches 5-24
- System features 1-1
- System modules 2-1
- System unit 2-1

T

- Time entry 7-3
- Tools needed for installation 5-3
- Tracks 6-2

Index

U

Underlining 2-3

Using the computer 6-8

V

Video, normal or reverse 2-3

W

Write-protect tabs 6-5

Write-protecting a diskette 6-5