

DELTA**GOLD**[®]

Premier

**Installation
Guide**

A MEMBER OF THE INSPECTORATE INTERNATIONAL GROUP OF COMPANIES 



COPYRIGHT

Copyright © 1987 by Delta Computer Corporation. All rights reserved. No part of this publication may be reproduced, transmitted, transcribed, stored in a retrieval system, or translated into any language or computer language, in any form or by any means, electronic, mechanical, magnetic, optical, chemical, manual or otherwise, without the prior written permission of Delta Computer Corp.

DISCLAIMER

Delta Computer Corp. makes no representations or warranties, either expressed or implied, with respect to the contents hereof and specifically disclaims any warranties or merchantability or fitness for any particular purpose. Delta Computer Corp. software described in this manual is sold or licensed "as is". Should the programs prove defective following their purchase, the buyer (and not Delta Computer Corp. or its dealer) assumes the entire cost of all necessary servicing, repair, or correction. In no event will Delta Computer Corp. be liable for any damages, including any lost profits, lost savings or any incidental or consequential damages arising from the use or inability to use such software. Furthermore, Delta Computer Corp. reserves the right to revise this publication and to make changes from time to time in the contents hereof without obligation of Delta Computer Corp. to notify any person of such revision or changes.

Delta Computer Corp.



FCC FREQUENCY INTERFERENCE STATEMENT

WARNING: This equipment has been certified to comply with the limits for a Class B computing device, pursuant to Subpart J of Part 15 of FCC Rules. Only peripherals (computer input/output devices, monitors, printers, etc.) certified to comply with the Class B limits may be attached to this computer. Operation with non-certified peripherals is likely to result in interference to radio and TV reception.

NOTICE 1:

This equipment generates and uses radio frequency energy and if not installed and used properly, that is, in strict accordance with manufacturer's instructions, may cause interference to radio and television reception. It has been type tested and found to comply with the limits for a Class B computing device in accordance with the specifications in Subpart J of Part 15 of FCC Rules, which are designed to provide reasonable protection against such interference in a residential installation. However, there is no guarantee that interference will not occur in a particular installation. If this equipment does cause interference to radio or television reception, which can be determined by turning the equipment off and on, the user is encouraged to try to correct the interference by one or more of the following measures:

1. Reorient the receiving antenna.
 2. Relocate the computer with respect to the receiver.
 3. Move the computer away from the receiver.
 4. Plug the computer into a different outlet so that the two devices are on different branch circuits.
 5. If necessary, the user should consult the dealer or an experienced radio/television technician for additional suggestions. The user may find the following booklet prepared by the Federal Communications Commission helpful: "How to Identify and Resolve Radio-TV Interference Problems". This booklet is available from the U.S. Government Printing Office, Washington, DC 20402, Stock No. 004-000-00345-4.
-

NOTICE 2:

The manufacturer is not responsible for any radio or TV interference caused by unauthorized modification to this equipment. It is the responsibilities of the user to correct such interference.

NOTICE 3:

1. This equipment has been type tested and found to meet FCC Class B emissions limits using shielded cables for connecting peripheral devices to the SERIAL and PRINTER PORTS of this equipment.
 2. It is the responsibilities of the user to use shielded cables in a residential installation, the shielded cables used should meet FCC Class B emission limits.
-

IMPORTANT SAFETY INSTRUCTIONS

1. Read all of these instructions.
 2. Save these instructions for later use.
 3. Follow all warnings and instructions marked on the product.
 4. Unplug this product from the wall outlet before cleaning. Do not use liquid cleaners or aerosol cleaners. Use a damp cloth for cleaning.
 5. Do not use this product near water.
 6. Do not place this product on an unstable cart, stand, or table. The product may fall, causing serious damage to the product.
 7. Slots and openings in the cabinet and the back or bottom are provided for ventilation; to ensure reliable operation of the product and to protect it from overheating, these openings must not be blocked or covered. The openings should never be blocked by placing the product on a bed, sofa, rug, or other similar surface. This product should never be placed near or over a radiator or heat register. This product should not be placed in a built-in installation unless proper ventilation is provided.
 8. This product should be operated from the type of power source indicated on the marking label. If you are not sure of the type of power available, consult your dealer or local power company.
-

9. This product is equipped with a 3-wire grounding type plug, a plug having a third (grounding) pin. This plug will only fit into a grounding-type power outlet. This is a safety feature. If you are unable to insert the plug into the outlet, contact your electrician to replace your obsolete outlet. Do not defeat the purpose of the grounding-type plug.
 10. Do not allow anything to rest on the power cord. Do not locate this product where persons will walk on the cord.
 11. If an extension cord is used with this product, make sure that the total of the ampere ratings on the products plugged into the extension cord do not exceed the extension cord ampere rating. Also, make sure that the total of all products plugged into the wall outlet does not exceed 15 amperes
 12. Never push objects of any kind into this product through cabinet slots as they may touch dangerous voltage points or short out parts that could result in a risk of fire or electric shock. Never spill liquid of any kind on the product.
 13. Do not attempt to service this product yourself, as opening or removing covers may expose you to dangerous voltage points or other risks. Refer all servicing to service personnel.
 14. Unplug this product from the wall outlet and refer servicing to qualified service personnel under the following conditions:
 - A. When the power cord or plug is damaged or frayed.
 - B. If liquid has been spilled into the product.
 - C. If the product has been exposed to rain or water.
-

- D. If the product does not operate normally when the operating instructions are followed. Adjust only those controls that are covered by the operating instructions since improper adjustment of other controls may result in damage and will often require extensive work by a qualified technician to restore the product to normal operation.
 - E. If the product has been dropped or the cabinet has been damaged.
 - F. If the product exhibits a distinct change in performance, indicating a need for service.
15. Replace battery with the same type as the product's battery we recommend only. Use of another battery may present a risk of fire or explosion.
 16. Warning, battery may explode if mistreated. Do not recharge, disassemble or dispose of in fire. Keep away from children and dispose of used battery promptly.
-



.

P R E F A C E

This manual shows you how to install, configure, and operate your **DELTAGOLD PREMIER**, a high performance 32-bit personal computer with full software and hardware compatibility with IBM PC/AT.

The new **DELTAGOLD PREMIER** works for you 2 to 4 times faster than IBM PC/AT by incorporating the powerful **Intel 80386** microprocessor which can operate at speeds up to 16MHz.

Instead of the conventional 512 KB, the **DELTAGOLD PREMIER** provides 1 MB of on-board system RAM. This enables you to install RAM BIOS, RAM disks, and Extended Memory Manager (EMM) for better performance.

Here is a summary of this manual :

- CHAPTER 1** *System Configuration*, gets you acquainted with the basic components of the system unit and the peripherals.
 - CHAPTER 2** *Installation and System Setup*, helps you unpack, assemble, and configure your system unit.
 - CHAPTER 3** *Keyboard*, explains basic keyboard functions.
-

- CHAPTER 4** *Operating Your System with DOS*, reviews the most common system commands that you will use to start operating your computer.
- CHAPTER 5** *Special System Utilities*, provides for advanced users information on the INSTALL and the SYSENV utilities. The former is very useful for installing high-performance RAM disks, EMM, and logical fixed disks; the latter for utilizing speedy RAM BIOS, changing CPU operating speed and system memory modes.
- APPENDIX A** *On-Board Switch Setting*, describes ways to set switches for ROM BIOS chip type, monitor type, CPU operating mode, and system memory mode.
- APPENDIX B** *Formatting the Hard Disk*, presents the procedures for physically formatting your hard disk.
- APPENDIX C** *Installing an Adapter Card*, gives you step-by-step instructions on the installation of adapter or expansion cards.
- APPENDIX D** *Jumper Setting*, provides information on co-processor jumper setting, system power connector, battery connector, etc.
- APPENDIX E** *System Specifications*, this section lists the specifications of your system and some available options.
-

- APPENDIX F** *The L.C.D. Clock*, explains how to set the time and data of your L.C.D. clock.
- APPENDIX G** *The DGI-EGA Card*, provides you with information regarding the DGI-EGA Card.
- GLOSSARY** Defines the terminology used in this book.

If you are an experienced user of personal computers you may want to review some sections in this manual lightly. However we do recommend that you read every section to get the most out of your new machine. If you are new to computers, it is a must that you read this manual. Almost all problems you will encounter while setting up your system can be solved by a quick review of the manuals. You will appreciate the ease with which the manuals read and the speed at which your system operates. Please take a few moments to familiarize yourself with the **PREMIER** via this manual. You've got a powerful machine on your hands and we want you to get the most out of it!

OPERATING SYSTEM

The DELTAGOLD PREMIER 32-Bit Personal Computer operates under the MS-DOS operating system. For details on the disk operating system, please refer to the following manuals:

- *MS-DOS User's/Reference Guide*
- *Supplement to the MS-DOS Operating System User's Guide*
- *MS-DOS Operating System Programmer's Reference* (option)

- * MS-DOS is a registered trademark of Microsoft Corporation.
 - * IBM, PC and PC AT are registered trademarks of IBM Corporation.
 - * Intel is a registered trademark of Intel Corporation.
 - * Symphony is a registered trademark of Lotus Development Corporation.
 - * Lotus 1-2-3 is a registered trademark of Lotus Development Corporation.
 - * DELTAGOLD is a registered trademark of DELTA Computer Corporation.
-

T A B L E O F C O N T E N T S

Chapter 1 System Configuration

System Unit.....	1-1
Rear Panel Switch And Connectors.....	1-3
System Power Socket.....	1-4
System Unit Power Switch.....	1-5
Video Monitor Power Socket.....	1-6
Keyboard Connector.....	1-7
Asynchronous Communications (EIA-RS-232C) And Parallel Interface Connectors.....	1-8
Diskette Drives.....	1-9
Hard Disk.....	1-11
System Main Board.....	1-12
Expansion Slots.....	1-13
Keyboard.....	1-15
Video Display Of System Unit.....	1-17

Chapter 2 System Setup

Unpacking.....	2-1
Procedures For Connecting The Display Monitor, Keyboard, And Printer.....	2-5
Connecting The System Power Cord.....	2-13
Starting Your System.....	2-14
Configuring Your System.....	2-18
Setting Up The Hard Disk.....	2-32

Chapter 3 Keyboard

<i>Keyboard Indicator Lights</i>	3-1
<i>Adjustable Legs</i>	3-2
<i>Keyboard Division</i>	3-3
<i>The Typewriter Key Area</i>	3-4
<i>Non-Character Keys</i>	3-5
<i>The Numeric Keypad</i>	3-7
<i>Cursor Control Keys In The Numeric Keypad</i>	3-10
<i>Easy-To-Use Cursor Control</i>	3-13
<i>The Function Keys</i>	3-14
<i>Special Purpose Keys</i>	3-15

Chapter 4 Operating Your System with DOS

<i>Write-Protecting Your Diskette</i>	4-1
<i>Diskette Handling</i>	4-2
<i>Inserting Diskette In The Disk Drive</i>	4-3
<i>Booting Your System</i>	4-4
<i>System Prompt</i>	4-7
<i>Formatting A Diskette</i>	4-9
<i>Making Backup Copies Of Your System Diskettes</i>	4-12
<i>Copying A File From One Disk Drive To Another</i>	4-15
<i>Copying More Than One File At One Time</i>	4-16
<i>Listing All Files On Default Drive</i>	4-20
<i>Listing All Files With Multiple Drives</i>	4-21
<i>Searching For A File</i>	4-22
<i>The RENAME (REN) Command</i>	4-23
<i>Renaming With Multiple Drives</i>	4-24
<i>The ERASE (DEL) Command</i>	4-25
<i>Erasing With Multiple Drives</i>	4-26

Chapter 5 Special System Utilities

<i>Installing RAM Disks.....</i>	<i>5-1</i>
<i>Installing Extended Memory Manager.....</i>	<i>5-5</i>
<i>The INSTALL Program.....</i>	<i>5-8</i>
<i>The SYSENV Program.....</i>	<i>5-19</i>

Appendix A On-Board Switch Setting

Appendix B Formatting The Hard Disk

Appendix C Installing An Adapter Card

Appendix D Jumper Setting

Appendix E System Specifications

Appendix F The L.C.D. Clock

Appendix G The DGI-EGA Card

Glossary



C H A P T E R 1

SYSTEM CONFIGURATION

1

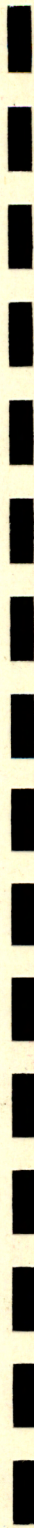

C H A P T E R 1

SYSTEM CONFIGURATION

In this chapter we will discuss the basic components of the system unit.

<i>System Unit.....</i>	<i>1-1</i>
<i>Rear Panel Switch and Connectors.....</i>	<i>1-3</i>
<i>System Power Socket.....</i>	<i>1-4</i>
<i>System Unit Power Switch.....</i>	<i>1-5</i>
<i>Video Monitor Power Socket.....</i>	<i>1-6</i>
<i>Keyboard Connector.....</i>	<i>1-7</i>
<i>Asynchronous Communications (EIA-RS-232C) and Parallel Interface Connectors.....</i>	<i>1-8</i>
<i>Diskette Drives.....</i>	<i>1-9</i>
<i>Hard Disk.....</i>	<i>1-11</i>
<i>System Main Board.....</i>	<i>1-12</i>
<i>Expansion Slots.....</i>	<i>1-13</i>
<i>Keyboard.....</i>	<i>1-15</i>
<i>Video Display of System Unit.....</i>	<i>1-17</i>



SYSTEM UNIT

The system unit consists of the system main board, power supply, adapter cards, disk drive(s), the microprocessor, RAM, ROM and the support chips, all enclosed in the system unit box.

On the front panel there are two indicator lights and one system lock. When power is on and the system is operating at the high speed (16 MHz), the light marked "16MHz/Smart" is illuminated. This light will go off when the system is operating at standard speed (8MHz). The other light (marked "Drive") illuminates when the hard disk is in use.

To use the system, you must first turn the key to the ON position. If the key is turned to the OFF position the system and keyboard are locked. When locked the PREMIER will not boot. This is a feature which prevents any unauthorized access to the computer system.

The RESET button on the front panel is used to restart (reboot) the system without having to turn off the power switch. To reboot the system, press the RESET button.

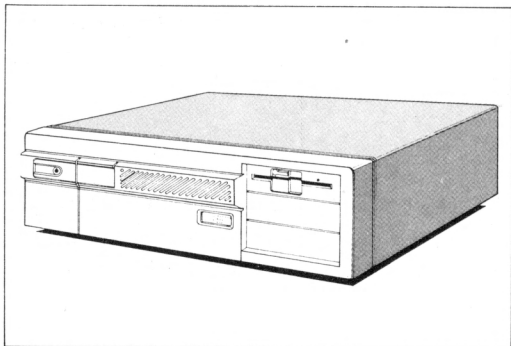

System Unit

REAR PANEL SWITCH AND CONNECTORS

The on/off switch, sockets and connectors for power, keyboard, video display and printer are located at the back of the system unit as shown below.

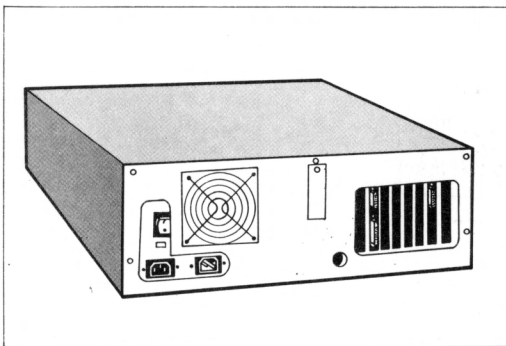

The Rear Panel

SYSTEM POWER SOCKET

The system power cord is to be plugged into the three-prong male socket as shown in the figure below.

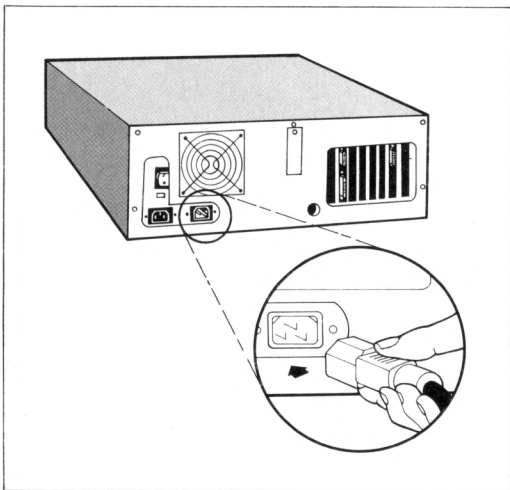

System Power Socket

SYSTEM UNIT POWER SWITCH

When you face the back of the system unit, the power switch is at the upper left corner. The power to the system is turned on by this switch.

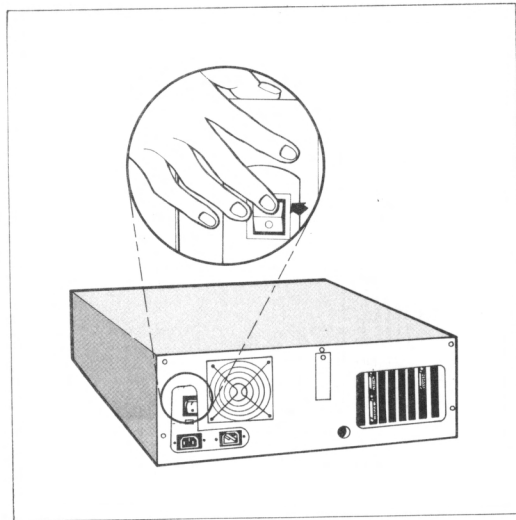

System Power Switch

VIDEO MONITOR POWER SOCKET

The monochrome display monitor connects to the socket below the system power switch and the power selector.

The voltage rating of the monitor must be the same as the voltage being supplied to the PC system unit when this socket is used to power the monitor.

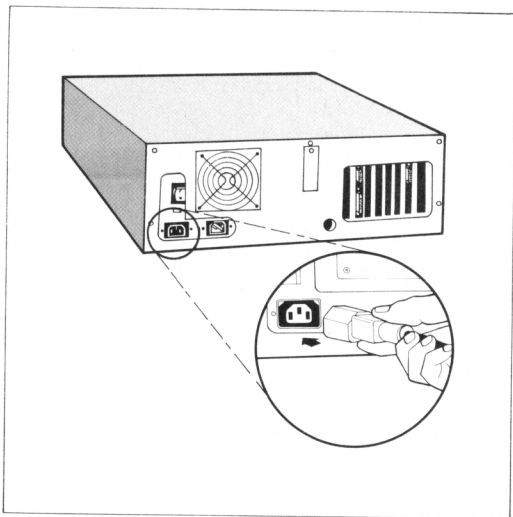

Power Socket for Monochrome Display Monitor

KEYBOARD CONNECTOR

The keyboard connector provides the interface for the system unit and the keyboard.

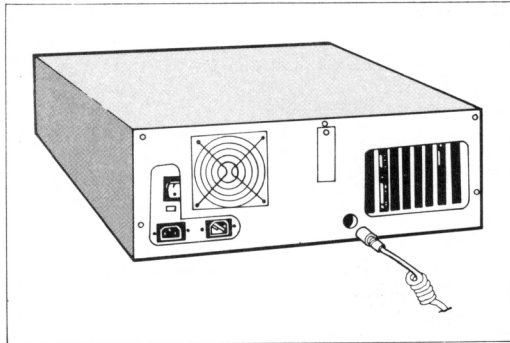

The Keyboard Connector

ASYNCHRONOUS COMMUNICATIONS (EIA-RS-232C) AND PARALLEL INTERFACE CONNECTORS

The asynchronous communications adapter is built into the Serial/Parallel Controller (SPB-A). This adapter card is inserted into one of the 62-pin slots on the system board.

The connectors for the serial/parallel devices are located at the rear panel of the system unit.

The 9-pin connector (serial) provides connection for the serial printer, data communications devices such as a modem or other serial devices.

The 25-pin connector (parallel) provides connection for devices such as a parallel printer or parallel plotter.

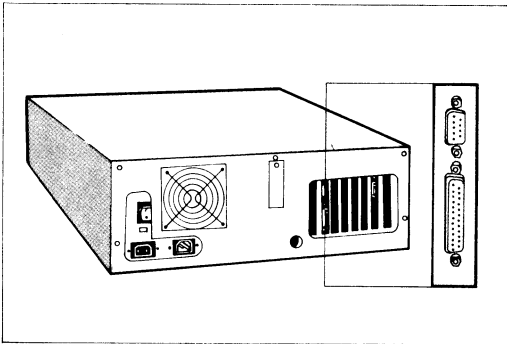

*Asynchronous Communications and
Parallel Interface Connector*

DISKETTE DRIVES

The system unit supports single density, double density and high capacity diskette drives with enough space to internally house five half-height devices. The usual configuration is one hard disk drive and one floppy diskette drive.

A high capacity diskette drive stores up to 1.2Mb. This is more than three times the present standard storage of a 360Kb diskette. With one high capacity diskette drive already installed, the second drive could be another high capacity diskette drive, or a 360Kb (double sided, double density), or a 180Kb (single sided, double density) diskette drive.

If you are concerned that you will need a 180/360Kb drive to read diskettes formatted on a 180/360Kb drive fear not. A 1.2Mb diskette drive can reliably read from 180/360Kb diskettes that have been written by 180/360Kb diskette drives. But the 180/360Kb diskettes written by the 1.2Mb drive should not be used in the 180/360Kb diskette drives.

With system units having both types of diskette drives, make sure that the correct diskette is used in the diskette drive.

Do not use the 1.2Mb diskette drive to write to a 180/360Kb diskette if you plan to use this diskette in the 180/360Kb drive again. After being written by the 1.2Mb diskette drive, the data on the 180/360Kb diskette can be used only with the 1.2Mb drive.

Only high capacity diskettes are to be used for the 1.2Mb format.

The usages of 180/360Kb and 1.2Mb drives are exactly the same.

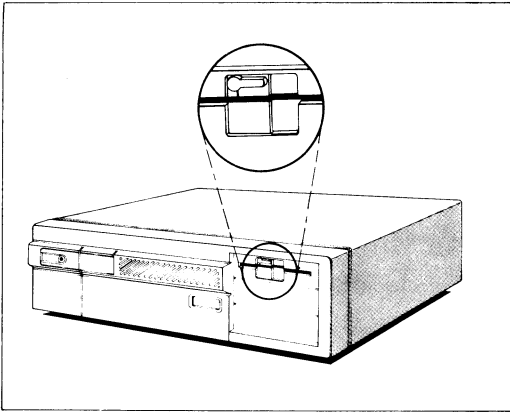

Diskette Drives

HARD DISK

A typical configuration usually includes a hard (fixed) disk.

To make full use of the capability of your computer system, we recommend the use of a hard disk. It is much more convenient, provides faster access to data, and much larger storage capacity than floppies. All applications programs and data (some programs have a copy protection scheme that prevents this) may be down loaded onto the hard disk, cutting down dramatically the shuffling of diskettes.

When the "DRIVE" light at the front panel goes on, it indicates that the hard disk is in use.

SYSTEM MAIN BOARD

The central processing unit (CPU), ROM, RAM, and the eight expansion slots are built on the main system board.

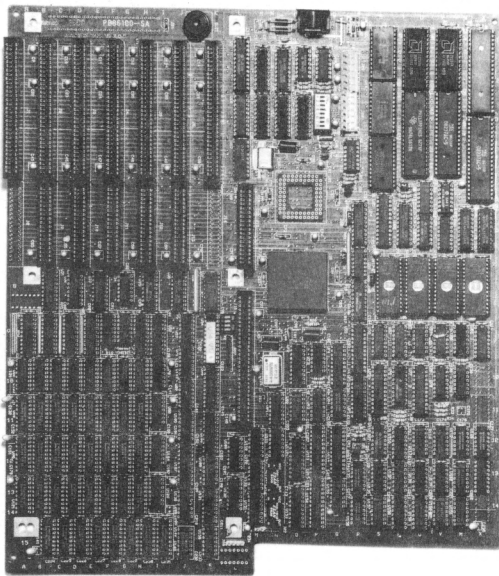

System Main Board

EXPANSION SLOTS

There are eight expansion slots on the main system board. These include two PC compatible expansion slots, five AT compatible expansion slots, and one 32-bit proprietary expansion slot especially for holding a 32-bit memory expansion board.

The back end of the expansion card is fastened to a metal "L" bracket which is screwed to the bulkhead at the back of the system unit. In this way, connectors can be attached to the rear of the "L" bracket for connection to peripheral devices without the need to open the system unit each time a device is to be connected.

A variety of expansion cards can be plugged into the slots to expand the functions of the system unit. Serial/parallel adapters, multi-function boards, various video adapters, disk controller adapters, memory expansion cards, etc., are all supported by the expansion slots of the DELTAGOLD PREMIER.

For details on installing an adapter or memory expansion card, please refer to Appendix C of this manual.

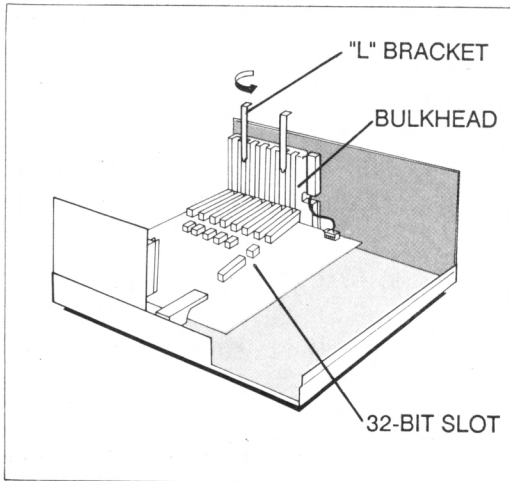

Expansion Slots

KEYBOARD

The keyboard has a typewriter style layout with function keys, cursor control keys and numeric keypad. The keys are low profile, full travel and sculptured.

The keyboard can be inclined for typing comfort. To tilt the keyboard, pull out the two pivotal legs at the bottom.

On the right there are four indicator lights that turn on when :

- the power is on.
- the Caps (capital) key is on.
- the Num (numeric) key is on.
- the Scroll lock is on. This causes the text to scroll without moving the cursor from its position.

To disable the keyboard, lock the system lock on the front panel. Now anything you type will not be processed by the computer, even if it is turned on.

The typewriter keyboard works like a typewriter. Suppose that the Caps Lock light is not on, press the A key and a lowercase "a" will be displayed on the monitor screen. Hold down the Shift key , press A again and you get the uppercase "A". Similarly, it works for the numbers and special characters such as "@", "#", etc.

But you must remember that when the Caps Lock light is on, only the letters of the alphabet will be displayed in the uppercase. To display "!", "_", ")", etc., you still have to press them with the Shift key.

If you have pressed the wrong key, and want to delete it, press the backspace key "<-". The cursor moves one position to the left deleting the character it encounters.

If you wish to delete the entire line of characters, just press the Esc key once. The cursor moves to the next line. Now you can start typing anew.

The numeric keypad has two modes. When you first turn on the computer, it controls the cursor movement on the screen. When you press the "<-" key, it will move the cursor one position to the left, and so on. But when you press the Num Lock key, the indicator lights up, you can now use the keys to enter numbers (These keys are software dependent. For example, the cursor control keys will not work from prompt A>).

You can use the cursor control keys to control the movement of the cursor when the numeric keypad is in the numeric mode. Simply hold down the shift key and it toggles the keypad into the alternate mode until it is released.

Refer to Chapter 3 for more details on keyboard usage.

VIDEO DISPLAY OF SYSTEM UNIT

Your computer system can use a vast array of video displays.

- 1) CGA (color graphics adapter) displays medium resolution text and graphics in color using 40 X 25 screen format. The highest resolution is 320 X 200 pixels. It can also display single-color text and graphics in 80 X 25 screen format with the best resolution of 640 X 200 pixels.
- 2) MDA (monochrome display adapter) displays only text in one color in 80 X 25 screen format. Crisp alphanumeric characters are displayed, having better resolution than that of CGA. If price is a consideration, and only word processors and spread sheets are used, we recommend that you use the MDA.
- 3) MGA (monochrome graphics adapter) displays both text and graphics in one color. Text is displayed in 80 X 25 screen format, with graphics resolution of 720 X 348 pixels which is higher than that of CGA.
- 4) EGA (Enhanced Graphics Adapter) displays graphics in color using 40 X 25 or 80 X 25 screen format. The highest resolution is 640 X 350 pixels for the enhanced color display, 640 X 200 pixels for the color display, and 640 X 350 pixels for the monochrome display.

An illustration of the display monitor is given in the following figure.

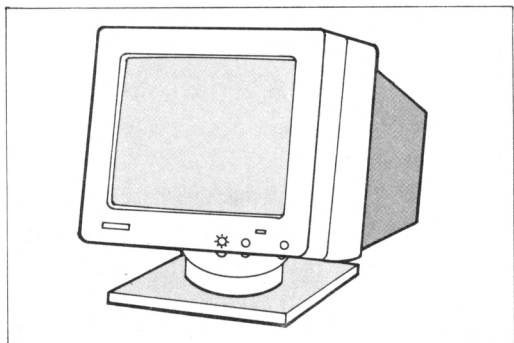

Video Monitor

CHAPTER 2

**SYSTEM
SETUP**



SYSTEM SETUP

In this chapter you will learn how to set up your system unit.

<i>Unpacking.....</i>	<i>2-1</i>
<i>Procedures For Connecting The Display Monitor, Keyboard, And Printer.....</i>	<i>2-5</i>
<i>Connecting Your Monitor.....</i>	<i>2-6</i>
<i>Connecting A Monochrome Display Monitor.....</i>	<i>2-6</i>
<i>Connecting A Color Graphics Monitor.....</i>	<i>2-8</i>
<i>Connecting Your Keyboard.....</i>	<i>2-10</i>
<i>Connecting Your Printer.....</i>	<i>2-11</i>
<i>Connecting The System Power Cord.....</i>	<i>2-13</i>
<i>Starting Your System.....</i>	<i>2-14</i>
<i>Configuring Your System.....</i>	<i>2-18</i>
<i>Setting The Real-Time Clock.....</i>	<i>2-22</i>
<i>Setting The Diskette Drive Type.....</i>	<i>2-23</i>
<i>Setting The Hard Disk Drive Type.....</i>	<i>2-24</i>
<i>Setting The Display Monitor Type.....</i>	<i>2-26</i>
<i>Setting The RAM Size Below 1MB.....</i>	<i>2-26</i>
<i>Setting The RAM Size Above 1MB.....</i>	<i>2-26</i>
<i>Another Way To Configure Your System.....</i>	<i>2-29</i>
<i>Setting Up The Hard Disk.....</i>	<i>2-32</i>



UNPACKING

Upon receiving your computer system, check that the packaging is in good condition. Otherwise, contact your dealer immediately.

Carefully unpack the system unit, keyboard, peripherals, cables, etc. Check that the items listed below are in good condition. If you have separately purchased other options, check that they are also included.

1. The system unit
2. One keyboard
3. One power cord to connect the system unit to the wall outlet
4. Three diskettes:
 - 1) Microsoft MS-DOS Operating System 1 of 2
 - 2) Microsoft MS-DOS Operating System 2 of 2
 - 3) Microsoft GW-BASIC 3.2
5. One copy each of
 - 1) *MS-DOS User's/Reference Guide*
 - 2) *Supplement to the MS-DOS Operating System User's Guide.*
 - 3) *Microsoft GW-BASIC Interpreter*
6. One copy of this manual

7. Two keys for the system unit
8. Two sets of drive guides and screws for installing additional disk drives
9. Screw driver and video tape

Save all the boxes and the packaging materials. You will need them again for repacking should you wish to transport your computer system.

► **NOTE** *Your computer accepts two levels of voltages. At the back of the unit and just below the power switch, there is a selector switch to set the voltage to 115V or 230V. Before turning on the computer, check that this switch is set for the correct voltage.*

Remove the magnetic head protection sheet from the diskette drive(s).

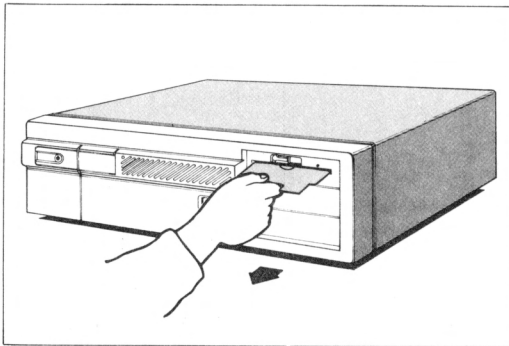

Removing Head Protection Sheet

Insert the key into the system lock and turn it to the position marked "ON" (clockwise).

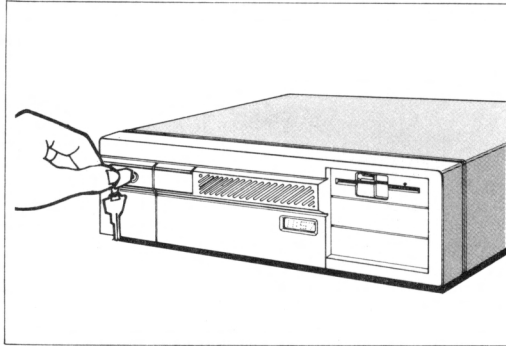

Inserting Key

Remove the five screws from the rear panel. Remove the top cover.

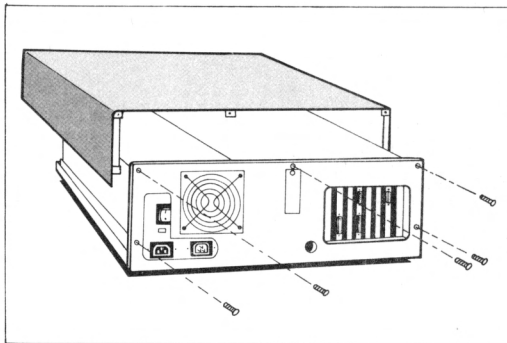

Removing Screws

The battery comes installed in a removable Velcro box. This box is attached to the inside middle of the rear panel.

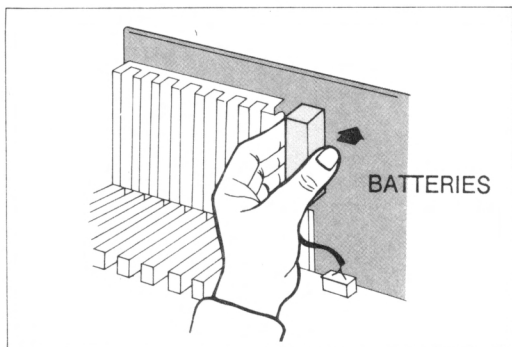

Attaching Batteries

Connect the battery cable connector to the system board connector.

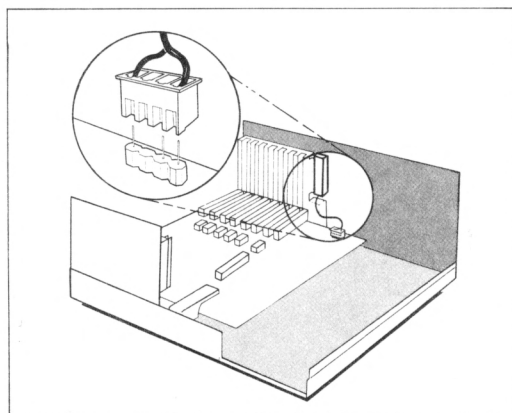

Connecting Battery to System Board

***PROCEDURES FOR CONNECTING THE DISPLAY
MONITOR, KEYBOARD, AND PRINTER***

Before installing the computer, check that the power source is properly grounded. Also check that the power switches of the system unit and peripherals are off, and that their power cords are not plugged into a power outlet.

► **CAUTION**

Before making the connections, make sure that the power to the system unit and all peripherals (printer, video display, etc.) are turned OFF. Connecting peripherals to your system while the power is on may damage your computer system or peripheral devices.

CONNECTING YOUR MONITOR

Connect monitor to video monitor power socket (switched receptacle) only if the monitor is rated and set for the same voltage as is being supplied to the PC system. If the monitor is rated for a different voltage or has a different type of plug, it should be connected directly to the appropriate branch circuit.

With the exception of the monochrome display monitor, other types of monitors will each have a separate power cable. Connect this cable to a grounded wall outlet.

CONNECTING A MONOCHROME DISPLAY MONITOR

If you wish to use a monochrome monitor, connect the monitor's signal cable to the adapter's 9-pin connector located at the back of the system unit. Tighten the two screws to fasten the cable to the adapter. Connect the monitor's power cable to the socket which is located just below the power selector switch.

Now you should check the switch settings on the system board and the jumper on the video card to be sure they are set appropriately (see Appendix A) and go through the installation routine (see configuring your system in this chapter). Your system defaults to monochrome so you should not have to change any switch setting. However you will have to run the setup program.

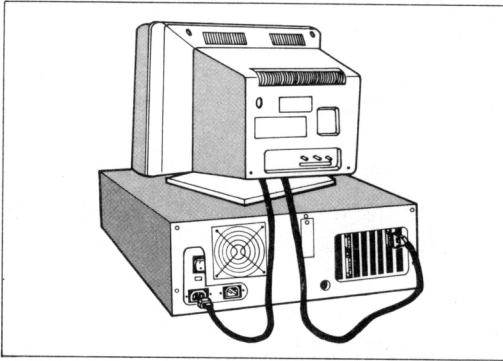

Connecting the Monochrome Monitor to System Unit

CONNECTING A COLOR GRAPHICS MONITOR

If your monitor is a color graphics monitor, insert the monitors adapter cable into the video connector on the back of the system unit. You must now change a DIP switch on your system board (see Appendix A), a jumper on the video card and the setup program. (your system defaults to a monochrome monitor)

Some different types of video adapters are listed below:

1. Color composite signal phone jack:
This phone jack connects to the video monitor which receives color composite signal input. The highest possible resolution that can be obtained when the video display monitor displays color graphics is 320 x 200 dots.
2. B/W composite signal phone jack:
This phone jack connects to the video monitor which receives B/W composite signal input. The highest possible resolution obtained is 640 x 200 dots.

3. Color direct drive 9-pin D connector:
This connector connects to the color direct drive display monitor. The highest possible resolution is 640 x 200 dots.

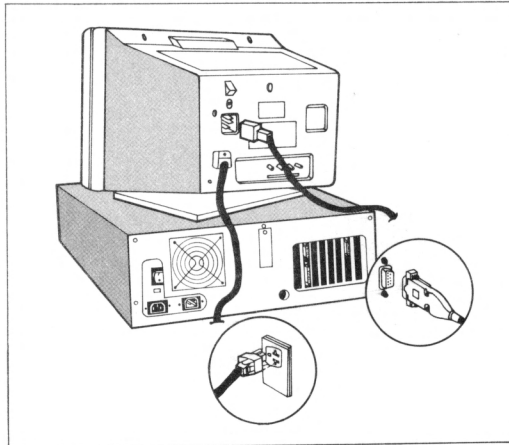

Connecting the Color Graphics Monitor to System Unit

CONNECTING YOUR KEYBOARD

To connect the keyboard to the system unit, plug the keyboard cable to the round keyboard socket at the rear panel as shown in the following figure.

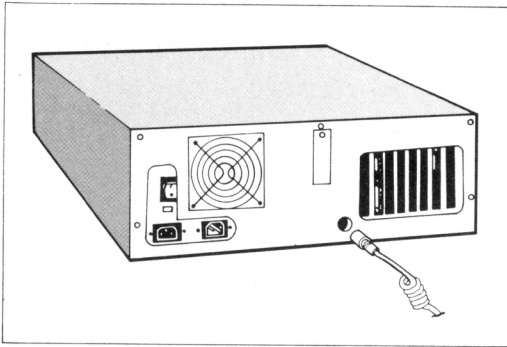

Connecting the Keyboard to System Unit

CONNECTING YOUR PRINTER

Before making the connection, study your printer manual and confirm the printer type. Basically there two types of printers: (1) parallel printers, and (2) serial printers.

PARALLEL PRINTERS

If you have a parallel printer, you should connect it to the parallel printer interface connector (female).

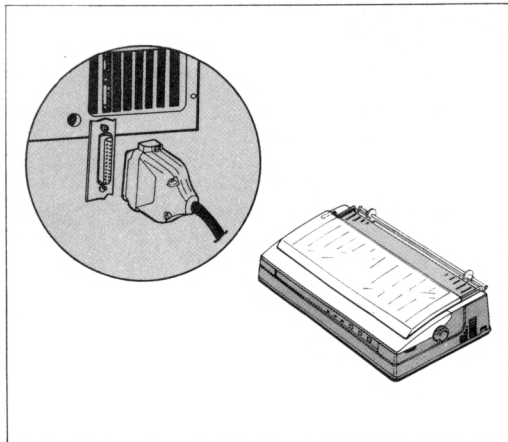

Connecting the Parallel Printer

SERIAL PRINTERS

A serial printer should be connected to the serial (RS-232) interface connector (male).

► **CAUTION** *Connecting a parallel printer to the serial interface could damage your printer or system unit.*

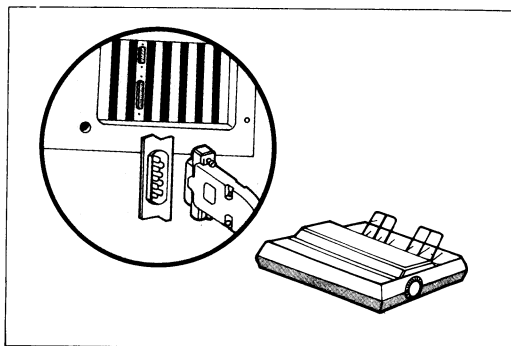

Connecting the Serial Printer

OTHER SERIAL CONNECTIONS

Other serial (RS-232) devices such as modem, terminal or a host computer can also be connected to the serial (RS-232) connector.

CONNECTING THE SYSTEM POWER CORD

To connect the power cord to the system unit, plug one end of the power cord to the system unit, and the other end to a grounded wall outlet.

STARTING YOUR SYSTEM

Make sure that the power to the system unit is not on.

Check that the head protection sheet is removed from the diskette drive(s).

If you have two diskette drives, insert the first DOS system diskette in the upper drive, which is called drive A. The lower drive is called drive B.

▶ CAUTION

Diskettes are vulnerable to damage and must be handled carefully. Hold the floppy diskette only at its corners. Don't bend it or spill anything on it. Don't touch the exposed portion of the diskette. Keep it away from extreme temperatures and magnetic fields of electric fans or motors.

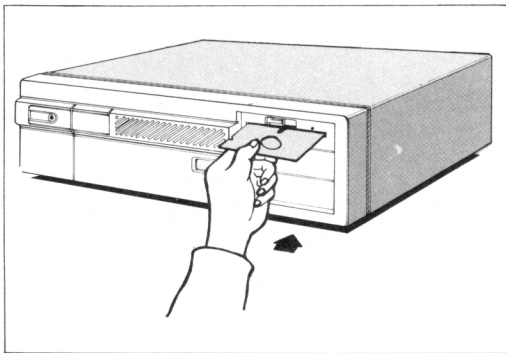

Inserting the Diskette

Turn the lever downwards to close the drive door.

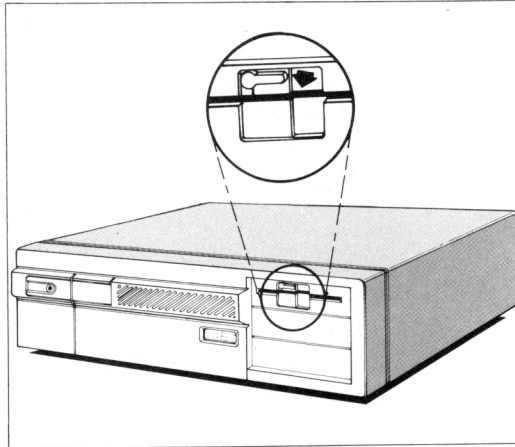

Closing the Drive Door

Turn on the power of the video monitor (if your monitor is not a monochrome display monitor).

Check again that the correct voltage is set at the selector switch. Turn on the power of your system unit. Do not press any key immediately after switching on the computer. If a keyboard key is pressed immediately after power-on, a keyboard error message will be displayed.

If you didn't insert the system diskette in drive A, after power-on this message will be displayed :

```
DISK BOOT FAILURE, INSERT SYSTEM DISK AND PRESS ENTER
```

Insert the system diskette in drive A and press Enter. After a few moments, you will see the following messages :

```
386 BIOS Vx.xx  
DELTA Computer Corp., An Inspectorate International Company  
XXX KILOBYTES MEMORY GOOD  
CMOS RAM ERROR, CHECK BATTERY/RUN SETUP  
PRESS F1 KEY...
```

The message "CMOS RAM ERROR" is displayed only on a new system unit that has not yet been configured, or on a system unit that has been incorrectly configured.

Press the function key F1. The following message is displayed :

```
Current date is Fri 1-01-1980  
Enter new date (mm-dd-yy): _
```

Don't enter anything now since you will be setting the real-time clock in your system unit, Just press the Enter key.

After you press Return, the following message is displayed :

```
Current time is 0:00:55.28  
Enter new time: _
```

Again, press Enter to ignore this message. The version number of the operating system and other messages are displayed. Finally, you see the DOS prompt :

```
A>
```

CONFIGURING YOUR SYSTEM

If you have reached here successfully, you are now ready to configure the system unit.

After configuration, the configuration parameters are stored in the memory of the computer. The power source for maintaining these parameters is from the battery. They are not lost when you turn off your computer. But if the battery is dead (it will last for about 2 years under normal operations), or becomes disconnected, the configuration program is lost and it will be necessary to reconfigure the system. Nothing in the computer is damaged, though. After reconfiguration, your computer system will work just like it did before.

The SETUP program in the second system diskette configures the system for the current date and time, type and number of diskette and hard disk drives, the type of display, and the amount of installed memory.

Insert the second system diskette in drive A. Type :

setup

and press the Return key. You should see this menu :

```
                SETUP Utility Version x.x
                Copyright (c) 1985, 86

<1>----->  SETUP CMOS RAM
<2>----->  HARD DISK FORMAT
<3>----->  SHIPZONE
<4>----->  EXIT

KEY IN OPTION NUMBER PLEASE ?_
```

Type 1

If there are no batteries connected to the system board, the screen will show :

```
CMOS BATTERY RUN DOWN OR NOT CONNECTED, FIX OR REPLACE
BEFORE RUNNING SETUP
Strike any key to continue...
```

You should :

- * Turn off your machine; remove the top cover of the system unit. If the battery is not connected, connect it now. If it has already been connected, check to see that the battery is making contact.
- * Check if the battery is good.
- * Put back the top cover and tighten the screws.
- * Turn on your machine.

You will see the first messages "386 BIOS VX.XX COPYRIGHT..." on the screen. Start the SETUP program again.

* * *

If the batteries are OK and properly connected, the following menu will be displayed :

```
DATE: 00/00/0000          TIME: 00:00:00

FLOPPY DRIVE A: NOT PRESENT  HI-CAPACITY  DOUBLE SIDED
FLOPPY DRIVE B: NOT PRESENT  HI-CAPACITY  DOUBLE SIDED

FIXED DISK 1: NOT PRESENT    01 02 03 04 05 06 07 08 09 10 11 12
                               13 14 15 16 17 18 19 20 21 22 23
FIXED DISK 2: NOT PRESENT    01 02 03 04 05 06 07 08 09 10 11 12
                               13 14 15 16 17 18 19 20 21 22 23

PRIMARY DISPLAY:             COLOR/GRAPHICS 80 COLUMN      MONOCHROME
                              COLOR/GRAPHICS 40 COLUMN      ENHANCED GRAPHICS
MEMORY BELOW 1MEG.:         0 256K 384K 512K 640K
MEMORY ABOVE 1MEG.:         00000K

RT, DN ARROW = NEXT ITEM      LT, UP ARROW = PREVIOUS ITEM
PGDN = NEXT TOPIC             PGUP = PREVIOUS TOPIC
ESC = EXIT WITH NO CHANGES   F10 = SET NEW VALUES AND EXIT

                               RETURN = SELECTS ITEM
```

SETTING THE REAL-TIME CLOCK

The first line asks you to fill in the date and time. To set the real-time clock, enter the current date and time. Thereafter, as long as the batteries are good and well connected, the real-time clock will accurately keep the date and time in the system.

After setting the date and time, you don't need to enter them again each time you turn on the system unit. The current date and time will be automatically entered from the real-time clock. When you see the operating system asking for new date and time, just press the Return key twice.

You can follow the instructions given at the bottom of the screen to configure your system.

If the current date is July 14, 1987, you enter :

07141987

The SETUP program will put the slashes after the month, date, and year for you; you don't need to enter the slashes. After typing the date, press the Return key to move to the next item, which is TIME. Should you make a typing error you can fix it by pressing the Backspace key, this will delete the error.

Remember to press the Return key to enter the values into the computer system. Pressing other keys like the cursor control keys will abort whatever you have entered.

► **NOTE** *In a color monitor, the entered values will be displayed in white. In a monochrome monitor, they will be highlighted, that is, the characters become brighter.*

If the current time is 2:35 p.m., you type :

143500

and press the Return key.

Note that your computer keeps time in a military format. So 2:35 p.m. is displayed as 14:35:00.00.

SETTING THE DISKETTE DRIVE TYPE

The next item "NOT PRESENT", on the right of "FLOPPY DRIVE A:", is now highlighted. If you have one high capacity, or 1.2Mb diskette drive, press the right direction arrow key to highlight "HI-CAPACITY", and then press the Return key.

To configure the second 1.2Mb diskette drive, you move to "FLOPPY DRIVE B:", and similarly select "HI-CAPACITY". If you have a 360Kb drive, move to "DOUBLE SIDED" and press Return for selection. Ignore this step if you don't have a second diskette drive.

SETTING THE HARD DISK DRIVE TYPE

If you have a hard (fixed) disk in your computer system, check the type of the hard disk with your dealer and select the correct type number in "FIXED DISK 1:" (e.g. Miniscribe 6053 40Mb hard disk is type 32).

HARD DISK CONFIGURATION TABLE

TYPE	CYLINDER	HEADS	WRITE PRE-COMP	LANDING ZONE
0	(indicates hard disk not present)			
1	306	4	128	305
2	615	4	300	615
3	615	6	300	615
4	940	8	512	940
5	940	6	512	940
6	615	4	OFFFFH	615
7	462	8	256	511
8	733	5	OFFFFH	733
9	900	15	OFFFFH	901
10	820	3	OFFFFH	820
11	855	5	OFFFFH	855
→12	855	7	OFFFFH	855
13	306	8	128	319
→14	733	7	OFFFFH	733
15	0	0	0	0
16	612	4	0	663
17	977	5	300	977
→18	977	7	OFFFFH	977
→19	1024	7	512	1023
20	733	5	300	732
→21	733	7	300	732
22	733	5	300	733
23	306	4	0	336
24	612	4	305	663
25	306	4	OFFFFH	340

HARD DISK CONFIGURATION TABLE

TYPE	CYLINDER	HEADS	WRITE PRE-COMP	LANDING ZONE	
	26	612	4	0FFFFH	670
→	27	698	7	300	732
	28	976	5	488	977
	29	306	4	0	340
	30	611	4	306	663
→	31	732	7	300	732
	32	1023	5	0FFFFH	1023
33-59		(reserved)			
	60	1024	9	0	1023
→	61	1224	7	0	1223
	62	1224	11	0	1223
	63	1224	15	0	1223
	64	1024	8	0	1023
	65	1024	11	0	1023
	66	918	11	0	1023
	67	925	9	0	926
	68	1024	10	0	1023
	69	1024	12	0	1023
	70	1024	13	0	1023
	71	1024	14	0	1023
	72	1024	2	0	1023
	73	1024	16	0	1023
	74	918	15	0	1023
	75	820	6	0	820
	76	1024	5	512	1023
	77	1024	8	512	1023
78-254		(reserved)			

If the type number is greater than 23, you can use the SETUP CMOS routine to key in the type number. Consequently the type number will not be shown in the SETUP CMOS RAM menu. For more details on the SETUP CMOS routine, please refer to the section, *Another way to configure your system* later in this chapter.

If you have a second hard disk drive, select the appropriate type number in "FIXED DISK 2:" and press Return. If your system is not installed with a hard disk, you need not enter anything for "FIXED DRIVE 1:" or "FIXED DRIVE 2:". Just select "NOT PRESENT" in both topics.

SETTING THE DISPLAY MONITOR TYPE

"PRIMARY DISPLAY:" is for selecting the display monitor type. Four types of display monitors are supported. Enter the appropriate type to match with your monitor.

SETTING THE RAM SIZE BELOW 1MB

After selecting the display type, you need to select the RAM size installed on the system board. Move to "MEMORY BELOW 1MEG.:". Select "640K" since all four memory modes of your system have 640Kb of RAM below 1Mb. 1Kb equals 1024 (2^{10}) bytes.

SETTING THE RAM SIZE ABOVE 1MB

1MEG. stands for 1Mb or one megabyte, which is the twentieth power of 2 (2^{20}), or 1,048,576 bytes. Thus, 1Mb = 1024Kb.

If the memory mode of your system is set to Mode 4 (default), move down to "MEMORY ABOVE 1MEG.:" and type :

256

next to "MEMORY ABOVE 1MEG.:".

```
DATE: 05/01/1987          TIME: 14:35:00
FLOPPY DRIVE A: NOT PRESENT  HI-CAPACITY  DOUBLE SIDED
FLOPPY DRIVE B: NOT PRESENT  HI-CAPACITY  DOUBLE SIDED
FIXED DISK 1: NOT PRESENT    01 02 03 04 05 06 07 08 09 10 11 12
                              13 14 15 16 17 18 19 20 21 22 23
FIXED DISK 2: NOT PRESENT    01 02 03 04 05 06 07 08 09 10 11 12
                              13 14 15 16 17 18 19 20 21 22 23
PRIMARY DISPLAY:             COLOR/GRAPHICS 80 COLUMN  MONOCHROME
                              COLOR/GRAPHICS 40 COLUMN  ENHANCED GRAPHICS
MEMORY BELOW 1MEG.:         0 256K 384K 512K 640K
MEMORY ABOVE 1MEG.:         00000K

RT, DN ARROW = NEXT ITEM    LT, UP ARROW = PREVIOUS ITEM
PGDN = NEXT TOPIC           PGUP = PREVIOUS TOPIC
ESC = EXIT WITH NO CHANGES F10 = SET NEW VALUES AND EXIT

RETURN = SELECTS ITEM
```

Check the values you have highlighted. When you are satisfied that all the values are correct, press the function key F10 to save the configuration values and to exit from the SETUP program. Soon after pressing F10, you will see the following message displayed:

"MEMORY ABOVE 1 MEG" :

ARE YOU SURE YOU WISH TO RECORD THESE CHANGES (Y/N) ?_

If you change your mind, press N and remain in the SETUP program. If you want the configuration saved, press Y, you will see :

TO RE-BOOT THE SYSTEM PRESS ENTER

ANOTHER WAY TO CONFIGURE YOUR SYSTEM

You can also change the configuration of your system using the SETUP CMOS routine by pressing the Ctrl, Alt and Esc keys simultaneously. In this way, the following screen will be shown :

```
1. DATE:          5/01/1987
2. TIME:          14/35/00
3. FLOPPY         DRIVE A:      1.2M FLOPPY DRIVE
4. FLOPPY         DRIVE B:      NOT PRESENT
5. FIXED          DISK 1:       TYPE 17
6. FIXED          DISK 2:       NOT PRESENT
7. PRIMARY DISPLAY: COLOR/GRAPHICS 80 COLUMN
8. MEMORY BELOW 1 MEG. : 640K
9. MEMORY ABOVE 1 MEG. : 256K

A. UPDATE ALL ITEMS
E. END AND REBOOT

SELECT WHICH ITEM?
```

► **CAUTION**

Once you end this routine, the system will reboot. There is no way to return to the point where you entered the routine.

The screen above shows an example of how the system was set up. The values for items 1 to 9 may not necessarily hold true for your system.

You can change any of the values for the above items by keying in the corresponding item number as shown on the screen.

CHANGING THE DATE

To change the date, key in **1** in response to "SELECT WHICH ITEM ?" and you will be prompted to enter the new date :

```
DATE: 05/01/87  
MONTH:  
DAY:  
YEAR:
```

The first line shows the old date. In the second, third, and fourth lines, you are asked to supply the month, day, and year respectively for the new date. If you do not want to change the

month, press the Return key when prompted. The same holds true for the day and the year. The valid values for month, day, and year are :

month	1 to 12
day	1 to 31
year	1900 to 2099 or 00 to 99

After you are finished with the first item, proceed and change the values in the other items as necessary.

UPDATING ITEMS 1 TO 9 IN THE SETUP ROUTINE

If you want to update all the items in the SETUP routine, press **A** and you will be prompted to change the values at the appropriate times.

QUITTING THE SETUP ROUTINE

Press **E** to end or quit the SETUP routine. Keep in mind that once you end the SETUP routine, the system will reboot and the new values will be set. (Remember the only way out of SETUP is to reboot. If you are working on a file do not enter set up without saving your work. If you do you will loose the unsaved file.).

SETTING UP THE HARD DISK

* Skip this section if you don't have a hard disk.

After configuring your system using the SETUP command, the hard disk must be formatted physically by using option number 2 in the SETUP menu. When the physical formatting is done, partition the hard disk by using the FDISK command. After an MS-DOS partition is created, you must format it logically using the FORMAT command before it can be used by MS-DOS.

Therefore, the steps involved in preparing a hard disk can be summarized as follows :

1. Use the SETUP command to configure your system.
2. Physically format the hard disk also using the SETUP command.
3. Partition the hard disk using the FDISK command.
4. Do a logical format on the MS-DOS partition created in step 3, using the FORMAT command :

```
format c:/s
```

For more details on FORMAT, please refer to the manual *MS-DOS User's/Reference Guide*.

FDISK and SETUP are fully documented in the manual *Supplement to the MS-DOS Operating System User's Guide*.

Physical formatting of the hard disk is described in this manual under Appendix B, *Formatting the Hard Disk*.



C H A P T E R 3

KEYBOARD

FUNCTION KEYS

TYPEWRITER KEYBOARD

CURSOR CONTROL KEYS

NUMERIC KEYPAD

DELTAGOLD





KEYBOARD

The DELTAGOLD PREMIER comes equipped with the DGK-200 keyboard. The following chapter will describe the features and general key layout. Should your keyboard appear slightly different do not worry. Our DGK-200 series keyboards may differ in some key designations but they are functionally identical.

<i>Keyboard Indicator Lights.....</i>	<i>3-1</i>
<i>Adjustable Legs.....</i>	<i>3-2</i>
<i>Keyboard Division.....</i>	<i>3-3</i>
<i>The Typewriter Key Area.....</i>	<i>3-4</i>
<i>Non-Character Keys.....</i>	<i>3-5</i>
<i>The Numeric Keypad.....</i>	<i>3-7</i>
<i>Cursor Control Keys In The Numeric Keypad.....</i>	<i>3-10</i>
<i>Easy-To-Use Cursor Control</i>	<i>3-13</i>
<i>The Function Keys.....</i>	<i>3-14</i>
<i>Special Purpose Keys.....</i>	<i>3-15</i>



KEYBOARD INDICATOR LIGHTS

Next to the Power Indicator Light on the top right-hand corner of the keyboard, there are three status lights to indicate the status of the Caps Lock, the Num Lock, and the Scroll Lock keys. When these lights are lit, the keys are activated.

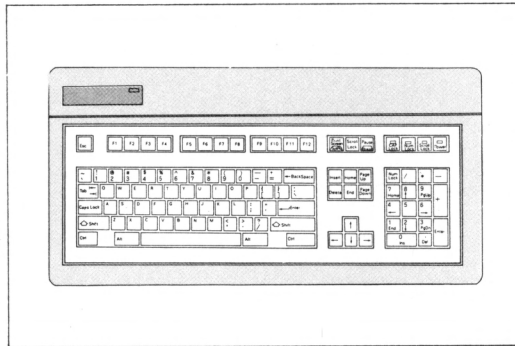

Keyboard

ADJUSTABLE LEGS

Two adjustable legs located at the back on the underside of the keyboard allow you to adjust the angle of the keyboard to two different positions for varied typing comfort.

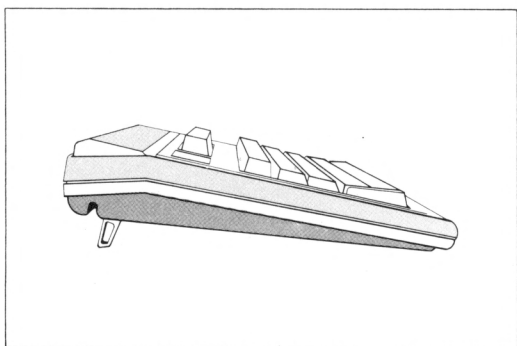

Adjustable Legs

KEYBOARD DIVISION

The keyboard is divided into the following sections:

- 1) The typewriter key area
- 2) The numeric keypad
- 3) The cursor control keys
- 4) The function keys

THE TYPEWRITER KEY AREA

This is the main part of the keyboard used for entering most of your data. It is used to enter alphanumeric text. The key layout and functionality are very similar to that of a typewriter.

Special characters and punctuation marks are displayed when used with the Shift key and character/punctuation keys. The instructions on the use of the Ctrl and the Alt keys are given later in this chapter.

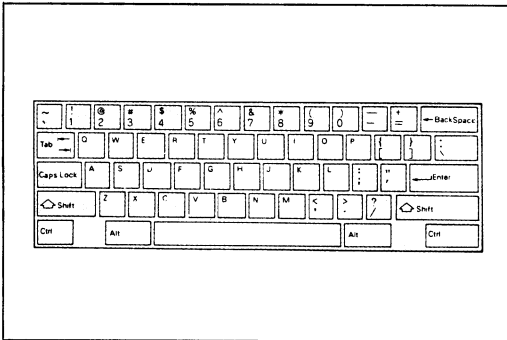

Typewriter Key Area

NON-CHARACTER KEYS



This is the Enter key. It is equivalent to the typewriter's Carriage Return. When the Enter key is pressed, the cursor will be moved to beginning of the next line.

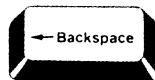

The <-- (Backspace) key works like the Backspace on a typewriter by moving the cursor one position to the left of its current position. But unlike a typewriter, in many applications packages this will also delete the character from the position the cursor has moved into.

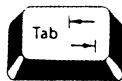

This is the Tab key which shifts the cursor eight spaces to the right each time it is pressed.

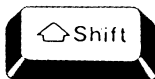

Your keyboard has two Shift keys performing the same function. They are used to switch the keys in the typewriter key area from lowercase to uppercase. In the numeric keypad the Shift key has the same function as the NumLock key, only when the shift key is released, the keypad returns to its prior state. All keys in the typewriter key area that have two values (the number keys, comma, period, minus) will take on the top value when used in combination with the shift key.

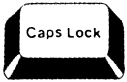

This key is used for entering uppercase alpha characters. Press the Caps Lock key, the light labeled "Caps Lock" on the keyboard will go on. Unlike the usual typewriter, symbols like special characters and some punctuation marks are not affected while the Caps Lock Light is on. To return to the lowercase mode, press Caps Lock again.



This key is always used with other key(s) to perform a certain function or command. Refer to the manual related to your application program or operating system for its usage.

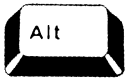

This the Alternate key. Software uses this key in many different ways. The documentation of any specific program will instruct you on the usage of this key.

THE NUMERIC KEYPAD

On the right of the keyboard is the numeric keypad. The keys have two specific functions, depending on whether they are in the *numeric* or the *cursor control* mode. The default mode is cursor control.

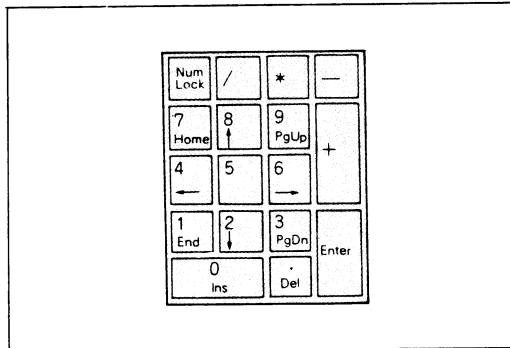

Numeric Keypad

When you are in the cursor control mode, the cursor can be shifted one space to any one of the four directions as indicated on the key top. To move the cursor more than one space, you are required to either press the key longer 0.5 seconds, or release the key and repeat the number of presses needed.

To enter the numeric mode, press the Num Lock key once. The NumLock Light will go on, indicating you are in the numeric mode. The keys are arranged like a calculator, and therefore makes them more convenient to use than the keys in the first row of the typewriter key area.

To return to the cursor control mode, press Num Lock again.

Note that the function of each key in the numeric keypad is dependent on software.

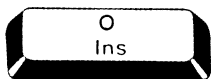

This key is used to insert character(s) anywhere in a line. When a character is inserted, all the data to the right of the cursor moves one position to the right. Under certain software applications, pressing this key once will cause the screen to toggle to the "Insert On" mode. Press this key again to exit from this mode, thus causing the cursor positioned character to be overwritten with what you type.



This key is used to erase the character where the cursor is positioned. When a character is deleted from a line, all the characters to the right of the cursor move one position to the left.



This key is used to enter the minus symbol.

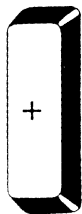

This key is used to enter the plus symbol.

CURSOR CONTROL KEYS IN THE NUMERIC KEYPAD

The cursor control keys as shown in the following figure are used to move the cursor to any part of the screen.

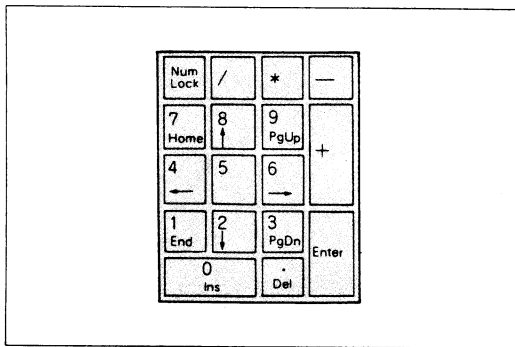

Cursor Control Keys



This key, called the "Cursor-Up" key, moves the cursor up one line at a time.

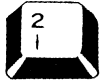

This key, called the "Cursor-Down" key, moves the cursor down one line at a time.



This key, called the "Cursor-Right" key, moves the cursor one position to the right.



This key, called the "Cursor-Left" key, moves the cursor one position to the left.



This is the Home key which moves the cursor to the top left corner of your screen.



The function of the End key depends on the definition of the application software.

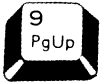

This key is called the "Page-Up" key which moves the cursor up by a distance of one screen. The distance of one screen depends on the application software.

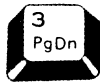

This key is called the "Page-Down" key which moves the cursor down a distance of one screen. The distance of one screen again depends on the application software.

EASY-TO-USE CURSOR CONTROL

While the numeric keypad is in the numeric mode, you may also need to move the cursor to other parts of the screen for editing. To do so, you could press the Shift key which will temporarily reverse the affect of the NumLock key or you could use the separate set of cursor control keys next to the numeric keypad. These keys are used exactly the same as the numeric keypad when it is in the cursor control mode.

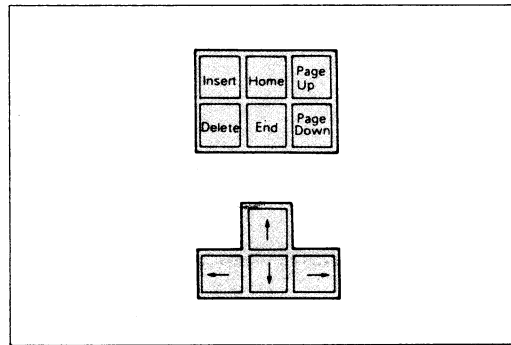

Easy-to-Use Cursor Control Keys

THE FUNCTION KEYS

The functions of these keys are dependent on the definitions of the application software that you use. For details on how to use them in the operating system, please refer to the manual, *MS-DOS User's/Reference Guide*.

SPECIAL PURPOSE KEYS



When this key is used together with the Shift key, all the data on the screen will be printed on the printer. When used with the Ctrl key, each line of data will be printed on the printer as it is being entered from the keyboard.

This key also serves as the System Request (Sys Rq) key whose function depends on software.



This is the Escape key. Its function will differ depending on the software package being used. Please refer to your applications software manual for a definition of the function of this key.



In some software packages, this key is used to determine the movements of the text on the screen. When the cursor reaches the top line or bottom line of the screen. Pressing this key once will cause the light labeled "Scroll Lock" on the keyboard to go on. To lock it off, press it again.

When this key is locked on, the cursor-up and the cursor-down keys move the text on the screen up or down one line without moving the cursor from its original position.



Pressing this combination of keys will cause a system to reset, which is almost the same as turning your computer off and then on again.



When the system command "break on" has been executed, pressing this combination of keys will cause the operating system to terminate the program which is running in the computer. Pressing C while holding down the Ctrl key produces the same effect.



If you want to pause the execution of a program when its contents are moving up the screen too fast for reading, you can press this combination of keys. To continue the scrolling press any key. Pressing S while holding down the Ctrl key or pressing the Pause key produces the same effect. (The function of this key sequence may vary with different software packages.)

CHAPTER 4

**OPERATING
YOUR
SYSTEM
WITH
DOS**

OPERATING YOUR SYSTEM WITH DOS

In this chapter you will learn to use some of the common system commands. We assume that your system unit has been set up (Chapter 2) and has two diskette drives, or one diskette drive and one hard disk drive. The commands are similar for single drive systems. Two drives are more convenient and will make things work faster.

The upper drive is drive A, and the lower drive is drive B. The hard disk drive is assigned drive C. For hard disk systems, just replace "B" with "C" when you see "B" in the message line.

<i>Write-Protecting Your Diskette</i>	4-1
<i>Diskette Handling</i>	4-2
<i>Inserting Diskette In The Disk Drive</i>	4-3
<i>Booting Your System</i>	4-4
<i>System Prompt</i>	4-7
<i>Formatting A Diskette</i>	4-9
<i>Making Backup Copies Of Your System Diskettes</i>	4-12
<i>One Drive System</i>	4-13
<i>Copying A File From One Disk Drive To Another</i>	4-15
<i>Copying More Than One File At One Time</i>	4-16
<i>Global Filename Characters</i>	4-16
<i>Listing All Files On Default Drive</i>	4-20
<i>Listing All Files With Multiple Drives</i>	4-21
<i>Searching For A File</i>	4-22
<i>The RENAME (REN) Command</i>	4-23
<i>Renaming With Multiple Drives</i>	4-24
<i>The ERASE (DEL) Command</i>	4-25
<i>Erasing With Multiple Drives</i>	4-26

WRITE-PROTECTING YOUR DISKETTE

The first thing you should do when you are ready to begin using your **DELTA GOLD PREMIER** is to examine the System 1 and System 2 diskettes, you should make sure that they are write-protected. Put a tab on the write-protect notch if the diskettes are not so protected. This will prevent inadvertent writing or deleting of data on the diskette.

The second important step is to make a backup copy of the original and work with the backup only. **Never use your original diskettes.** The reason for this is that in the event that the backups you made are lost or damaged you can make another backup copy using the original. A diagram of the floppy diskette is given in the following figure.

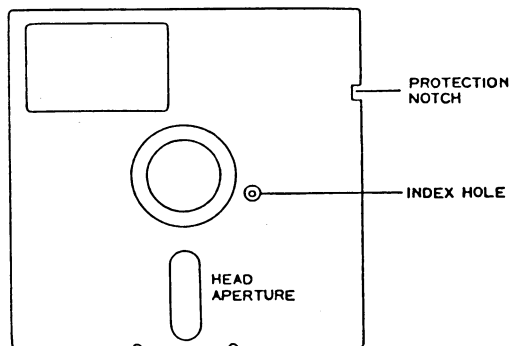

Floppy Diskette

DISKETTE HANDLING

Under no circumstances is the exposed portion of the head aperture to be touched, scratched, or left in the open for dust or moisture to collect. Extreme temperatures are also to be avoided. The ambient temperature should be around 45 to 105 degrees Fahrenheit (8 to 40 degrees Centigrade).

When the diskette is removed from the diskette drive, it is to be immediately returned into its protective envelope. It should not be bent, thrown, or written on with anything harder than a felt tip pen (when you write a label for a diskette, write the label before you attach it to the disk). All diskettes should be kept far away from magnetic fields, like those of electric fans and motors.

The diskette is not to be removed from the drive as long as the in-use light is on. If the disk drive head cannot read a diskette because it is damaged or has the wrong file or operating system on it, the in-use light will not go off. If you are confronted with this problem reset the machine (Ctrl + Alt + Del).

► **NOTE** *If you reset the machine you will lose all data not yet written to disk.*

INSERTING DISKETTE IN THE DISK DRIVE

Hold the diskette lightly near its corner. Keeping the label side up, insert the system diskette gently all the way into the drive until the diskette is properly seated. Turn the lever downwards to close the drive door.

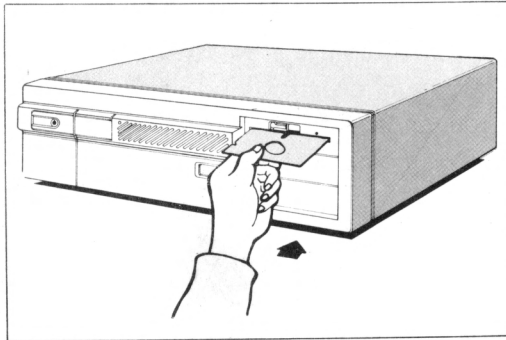

BOOTING YOUR SYSTEM

To boot your system, that is, to load the Disk Operating System (DOS) into the computer memory for use, insert system diskette 1 into drive A before you turn on the computer. If you have a hard disk and it has been properly formatted with operating system installed on it, ignore the above step. Just switch the system on.

Each time you power up your computer, it will check the RAM on the system board or memory expansion board for defects. This takes some time, depending on how much memory is installed. The more memory, the longer it will take.

When the system is booted, your monitor will display the following messages :

```
Current date is Fri 1-01-1980
Enter new date (mm-dd-yy): _
```

If you want the current date, just press the ENTER key, as the current date has been set by the real-time clock. Or you can set a new date. Suppose the date you want to enter is July 16, 1987, you may type any one of the following :

7/16/87

or

7/16/1987

or

7-16-87

or

7-16-1987

After you type the date and press the ENTER key, the operating system will enter the day of the week for you. So July 16, 1987 will be displayed as Thurs July 16, 1987.

It is not necessary to enter the month, date, and year in this order. An Englishman would prefer to enter the date first, while a Swede might enter the year first. This can be modified by copying the system diskette to another with the SELECT command. See the manual *Supplement to the MS-DOS Operating System User's Guide* for details.

If you have not made a mistake, you should see the following message :

```
Current time is 0:01:57.94
```

```
Enter new time : _
```

The above time is zero hour, one minute and 57.94 seconds. Again you may either choose to ignore it and hit the Enter key, or you may enter a new time.

If the time you want to enter is 8:30 p.m., type :

```
20:30:00
```

The colons are used to separate the hour, minute, and second. Hundredth of a second is separated by a period. Your system displays time in a military format.

If you have entered all the instructions correctly, you will see messages about the company name of the operating system, the version number, etc., followed by the system prompt.

SYSTEM PROMPT

A system prompt can be A> or C>, depending on your default (active) drive. If you start up your computer with the system diskette in drive A, the system prompt will be A>, indicating that the default is A. If you have a hard disk, and no system diskette in drive A, after booting the system prompt appears as C> (if you have formatted your hard disk and placed a system on it. See Appendix B), indicating that the default is drive C.

If you want to change the default drive to B, type :

B:

and press ENTER. The prompt becomes :

B>

Now drive B is the default drive.

► **NOTE**

If you have only one diskette drive, this drive is referred to as both drives A and B.

If you have one diskette drive and one hard disk drive, the diskette drive is referred to as A and B, and the hard disk as drive C.

The system unit is now ready to accept your instructions and the first thing you should do is to make backup copies of the MS-DOS system diskettes.

The procedures are as follows :

1. Format two new diskettes with the FORMAT command.
2. Copy all files from the original system diskettes to the new diskettes by using the COPY command.
3. To see if the files are correctly copied, use the COMP command to compare the files in the original and the new diskettes.

Details are given in the following sections.

You may also use the DISKCOPY command.

FORMATTING A DISKETTE

A diskette that has not been formatted cannot be used since there are no tracks or sectors on which information can be written to. For information on tracks and sectors of diskettes please refer to *Glossary/Index* of this manual.

► **WARNING** *After formatting a diskette or hard disk, all information previously written on it is completely destroyed. So use FORMAT on new diskettes, on diskettes with files you no longer need, or diskettes you have backed up.*

To format a diskette, leave system diskette 1 in drive A and enter :

format b:/s

You may type this command either in lowercase or uppercase, or a combination of lower and uppercase.

This will load the FORMAT program from the system diskette into memory and then displays this message :

**Insert new diskette for drive B:
and strike ENTER when ready**

If the new diskette is already in drive B, just press the ENTER key. Otherwise, insert a new diskette in drive B, close the drive door and press ENTER.

If you have only one disk drive, remove the system diskette from drive A and insert the new diskette. Close the drive door and press ENTER.

When formatting is complete, the following messages are displayed :

```
Format Complete  
System Transferred
```

```
xxxxxx bytes total disk space  
xxxxx bytes used by system  
xxxxxx bytes available on disk
```

```
Format another (Y/N)?
```

The in-use light of drive B will go out.

Press **y** or **Y** to repeat the formatting process. Remove the formatted diskette and replace it with a new diskette, then press ENTER.

If you don't need to format another diskette, type **n** or **N** to exit from FORMAT.

► **IMPORTANT**

If you want to format a double-density (360Kb) diskette in a high-capacity (1.2Mb) diskette drive, remember to add the parameter "/4" before "/s" in the FORMAT command. If you didn't add this parameter, the formatted diskette would contain quite a few bad sectors, causing the data stored on them to be unreadable. Another problem is that all the data on this diskette couldn't be read in a 360Kb diskette drive. There won't be any problems reading the 360Kb diskette in a 1.2Mb drive if you add the "/4" parameter when formatting it in a 1.2Mb drive. All the "/s" parameter does is copy the system. If you do not need to boot from this disk you should not use the "/s" parameter.

MAKING BACKUP COPIES OF YOUR SYSTEM DISKETTES

Before attempting to backup your system diskette, make sure that it is write-protected by putting a tab on the write-protection notch.

If you have two drives, the system diskette will be in drive A, and the newly formatted diskette in drive B. To copy all the files from the system diskette to the formatted diskette, type :

```
copy *.* b:/v
```

and press the ENTER key, you will see the in-use lights of drives A and B go alternately on and off as the files in the system diskette are being copied to the destination diskette.

► **NOTE** *"/v" parameter verifies that the files copied to the destination disk are correctly written. As the system needs to check for correct data recording, a little more time is required than copying without this parameter.*

When a file is being copied, its name will be displayed on the screen. After all the files are copied, you will see this message :

```
x File(s) copied
```

"x" is the number of files that were successfully copied. Remove the back-up copy from the drive and put a label on it for easy identification.

► **NOTE** *Write the labels before you attach them to the diskette. If you attach a label to the diskette before writing on it, write on it with a felt tip pen and applying very little pressure.*

Repeat the COPY process with the other system diskette.

ONE DRIVE SYSTEM

Make sure that the system diskette is write-protected, and inserted in drive A. Type :

```
copy *.* b:/v
```

and press the ENTER key.

Depending on how much memory your system has, the files will first be read into memory before transferring to the target diskette. The more memory you have, the faster all the files will be copied.

This message will be displayed :

```
Insert diskette for drive B: and strike  
any key when ready
```

Remember "drive A" stands for the source diskette and "drive B" is for the destination diskette.

After the system has completed writing to the destination diskette, it will prompt you to insert the source diskette with this message:

**Insert diskette for drive A: and strike
any key when ready**

Remove the destination diskette from the drive and insert the source diskette. Each time you repeat the actions, remember to press a key after closing the drive door to activate the reading/writing process.

Each filename will be displayed on the screen, until all the files are copied.

COPYING A FILE FROM ONE DISK DRIVE TO ANOTHER

If drive A is the currently logged drive, you will see the system prompt A> displayed. Follow the steps described below :

1. Insert the diskette with the source files to drive A.
2. Insert the target or backup diskette to drive B.
3. If the file you want to copy is called "SAMPLE.EXE", type in the following :

copy sample.exe b:

and press ENTER. The file will be copied to the diskette in drive B, and it will have the name "SAMPLE.EXE". On the screen you will see the following message :

```
1 File(s) copied
A>
```

This message will always appear whenever you have successfully copied a file. If you would like a different filename for the destination file, you are then to enter the new filename like this :

copy sample.exe b:prog.exe

COPYING MORE THAN ONE FILE AT ONE TIME

A filename is made up of one to eight characters. The characters that are allowed may be any one of the following :

- Alphabets **A** through **Z**
- Numbers **0** through **9**
- Special characters **!, @, #, \$, %, &, (), -, _, ^, ~, ' ,**

A filename is sometimes followed by a filename extension which is made up of one to three characters. The filename extension comes after the period that terminates the filename.

GLOBAL FILENAME CHARACTERS

When global filename characters are used for file specification, a group of files can be accessed or processed at one time. The global filename characters are sometimes referred to as "wildcard characters".

Two global filename characters are used for file specification: **?** and *****. You have already used ***** to backup the system diskettes.

? is used to substitute any *one* character in a filename or a filename extension. It can represent any character used in the filename.

pm?.bas refers to all the following files :

pm1.bas
pm2.bas
pmx.bas
pmy.bas
pm%.bas
pm&.bas

.
.
.

As a ? represents only one character in a filename or its extension, an * represents the *complete* filename or its extension. For example, the file specification *.* means any one of the following filenames and their extensions :

XXXXXXXXX.XXX
xxxxyyzz.abc
a1234567.bas
b%!.@zxy&.int
PROJECT.BAS

.
.
.

The global characters ? and * can be used together in a global file specification. For example, the file specification **pm?.*** can be used to refer to the following files :

pm1.bak
pm2.bas
pmx.int
pmy.com
pmm.exe

The global characters are useful to copy, delete or list a group of files in a directory.

The use of global filename characters allows a group of files to be processed at one time when the file specifications of these files match the file specifications you entered with global characters.

As a result, when a global file specification is entered following the COPY command, it allows a group of files to be copied at one time.

If you enter the global file specification **pm?.*** following the COPY command, then all the files which match this file specification will be copied. If you enter the global file specification ***.*** following the COPY command, then all the files in the default drive are copied to the destination drive.

* * *

Other frequently used commands are DIR, RENAME and ERASE.

The DIR command displays the directory of the files on a diskette or searches for specific files with filenames that match those in the command line. The RENAME command enables you to change the filename. The ERASE command deletes the specified file(s) in the command line.

LISTING ALL FILES ON DEFAULT DRIVE

If you want to examine all the files on the diskette in the default drive, type :

dir

and press ENTER. This command will display a list of the files on your video monitor, including their filenames and extensions, the size of each file, the date and time when the files were last accessed, and the amount of unused storage space available on the diskette.

The file information is displayed on the screen one line after the other, moving the first line upwards as the next line is displayed. This screen movement is called scrolling. If the scrolling of the screen messages is too fast for you to read, you may press the Num Lock key while holding down the Ctrl key to freeze the scrolling. When you have finished reading the screen, press any key to continue scrolling.

After all the files have been listed, the system prompt will appear again on the screen.

If you want to print out a copy of the screen messages for future reference, press Shift and Print Screen together.

LISTING ALL FILES WITH MULTIPLE DRIVES

Suppose the default drive is A and you wish to list the files on the diskette in Drive B. Type :

dir b:

and press ENTER.

SEARCHING FOR A FILE

Using DIR, it is rather slow to go through a screenful of file names to see if a specific file exists on a diskette, especially when the disk contains many files. To simplify your file search, type the filename (global characters * and ? are allowed) after **dir**. For example, type :

```
dir basica.com
```

After the ENTER key is pressed, the file name, extension, size of file, last access date and time, and the free storage space left on the diskette are displayed. If the file specified after the DIR command line is not found on the diskette, the following message will be displayed :

```
File not found
```

THE RENAME (REN) COMMAND

The RENAME command changes the filename of an existing file.

The syntax is :

```
rename oldname.ext newname.ext
```

or

```
ren oldname.ext newname.ext
```

Note that the old filename (the file to be renamed) comes first in the command line, and the old filename and the new filename are separated by a space.

Also note that if there are other files existing on the disk, the new filename must not have the identical name as one of the files on the disk. If you attempt to rename a file with a name that already exists on the disk, the old file will not be renamed and you will see this message displayed on the screen :

```
Duplicate filename or file not found
```

RENAMING WITH MULTIPLE DRIVES

The following steps are taken to rename a file.

1. If the default drive is A and the file to be renamed is in drive B, first change the default drive to Drive B by entering :

b:

The screen shows :

```
B>
```

2. Enter the following command line :

```
rename oldname.ext newname.ext
```

3. After a short while, the prompt "B>" will appear, signaling that the file has been renamed.

THE ERASE (DEL) COMMAND

To delete a file on the diskette, use the ERASE command. The following example shows how to use the ERASE command.

```
erase filename.ext
```

ERASING WITH MULTIPLE DRIVES

If you have a diskette in the default drive A, and the file you wish to delete is in drive B. Type :

```
erase b:filename.ext
```

and press ENTER. You can also change the default drive to B first, then enter :

```
erase filename.ext
```

If you type :

```
erase *.*
```

You will be asked for confirmation :

```
Are you sure (Y/N)?
```

Press **y** if you want the entire disk or directory erased, and **n** if you change your mind.

The DEL command is identical to the ERASE command, also used to erase (delete) a file.

CHAPTER 5

SPECIAL SYSTEM UTILITIES

5

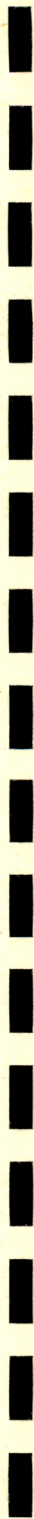

SPECIAL SYSTEM UTILITIES

In this chapter, you will learn how to install RAM disks and the Extended Memory Manager (EMM). You will also learn how to use the two unique programs, INSTALL and SYSENV.

<i>Installing RAM Disks.....</i>	<i>5-1</i>
<i>What Is A RAM Disk?.....</i>	<i>5-1</i>
<i>How To Install A RAM Disk?.....</i>	<i>5-1</i>
<i>Insufficient Memory.....</i>	<i>5-3</i>
<i>Installing Extended Memory Manager.....</i>	<i>5-5</i>
<i>What Is Extended Memory Manager?.....</i>	<i>5-5</i>
<i>How To Install EMM?.....</i>	<i>5-5</i>
<i>The INSTALL Program.....</i>	<i>5-8</i>
<i>Install HARDRIVE.SYS.....</i>	<i>5-10</i>
<i>Install VDISK.SYS.....</i>	<i>5-11</i>
<i>Install EMM.SYS.....</i>	<i>5-13</i>
<i>Install EKIP Program.....</i>	<i>5-15</i>
<i>Select Disk Drive To Store Configuration.....</i>	<i>5-16</i>
<i>Save The Installation And Exit.....</i>	<i>5-17</i>
<i>The SYSENV Program.....</i>	<i>5-19</i>
<i>Changing BIOS Access Location And Memory Mode.....</i>	<i>5-20</i>
<i>Changing CPU Operating Speed.....</i>	<i>5-21</i>



INSTALLING RAM DISKS

WHAT IS A RAM DISK?

A RAM disk, also called a "virtual disk", reserves a portion of the computer memory to be used as a disk drive. The advantage of a RAM disk over other disks (hard or floppy) is that a RAM disk provides much faster access when reading and/or writing files. The disadvantage is that if power is lost to the system unit or you forget to save your data on floppy or hard disk and power down, your data is lost.

When you have two floppy diskette drives, the RAM disk is assigned as drive C. When if you have a fixed disk, the RAM disk is assigned drive D.

More than one RAM disk can be installed, depending on the size of RAM disks and the memory available. In the two floppy disk drives configuration, the first RAM disk is assigned as drive C, the second as D, and so forth.

HOW TO INSTALL A RAM DISK?

You can use the INSTALL utility on your system diskette to aid you in creating a CONFIG.SYS file to install a RAM disk. You can also do this by following the procedure given below.

1. On the diskette or fixed disk with which you start MS-DOS, create a file called CONFIG.SYS which contains the statement:

device = ramdrive.sys

this is done in the following manner. At prompt A>, type the following:

copy con:config.sys (Press Enter)
device=ramdrive.sys (Press Enter)
(Press F6 and then Enter)

To confirm that the statement is correctly written to the file, enter:

type config.sys (Press Enter)

the information displayed should be identical to "DEVICE = RAMDRIVE.SYS", otherwise repeat the process and create CONFIG.SYS again.

2. Make sure that the diskette/fixed disk on which you just created the CONFIG.SYS file can start the system and also that it contains the file RAMDRIVE.SYS. Restart MS-DOS by pressing the three keys, Ctrl-Alt-Del, together. If you are using sub- directories on your hard (fixed) disk, be sure that config.sys and ramdrive.sys are in the default directory.

3. If the RAM disk is successfully installed, the screen displays a message similar to this:

```
Microsoft RAMDRIVE Version x.xx virtual disk X:  
Disk size: 64 k  
Sector size: 128 bytes  
Allocation unit: 1 sectors  
Directory entries: 64
```

Now you have created a RAM disk with 64Kb of memory which is the default memory size for RAM disks. If there is less than 64Kb of installed memory, the RAM disk cannot be created.

A RAM disk is pre-formatted and can be used just like another disk drive. Almost all MS-DOS commands are applicable to a RAM disk as if it were a physical disk drive.

- **WARNING** *All data in the RAM disks is lost after system reboot or when power is turned off. Make sure that the files are saved to a fixed disk or floppy diskette before rebooting or turning off the power.*

INSUFFICIENT MEMORY

A RAM disk takes up computer memory. If after installing a RAM disk and a program displays something to this effect:

```
Insufficient memory
```

you must either reduce the size of the RAM disk or do not install it.

For more information on RAM disks, refer to the section titled "RAMDRIVE" in the manual *Supplement to the MS-DOS Operating System User's Guide*.

► **NOTE**

If you use the RAMDRIVE utility to install a virtual disk (RAM disk), be sure that your memory mode is in Mode 2 or Mode 4 (Using RAM BIOS).

You can also use the VDISK utility in system diskette 1 to create a virtual disk. The procedure is similar to that of using the RAMDRIVE utility described above. If you want to install an extended memory manager (EMM) in addition to a virtual disk, remember to use only the VDISK utility while creating the virtual disk.

INSTALLING EXTENDED MEMORY MANAGER

WHAT IS EXTENDED MEMORY MANAGER?

Extended Memory Manager (EMM) supports management of memory above 1Mb. The EMM specifications follow the Expanded Memory Standard (EMS) defined by Lotus / Intel / Microsoft (LIM). There are many software packages now developed for this standard to expand their data working space above the 640Kb limitation that exists on all PC/PC-AT and compatibles using MS-DOS. EMM now supports memory management above 1Mb for these packages to access through EMS function calls.

HOW TO INSTALL EMM?

You can use the INSTALL utility on your system diskette to aid you in creating a CONFIG.SYS file to install EMM. You can also do this by following the procedure given below.

1. On the diskette or fixed disk with which you start MS-DOS, create a file called CONFIG.SYS which contains the statement:

```
device = emm.sys [sss [mmm]]
```

this is done in the following manner. At prompt A>, type the following:

```
copy con:config.sys (Press Enter)
device=emm.sys [sss [mmm]] (Press Enter)
(Press F6 and then Enter)
```

where "sss" is the desired buffer size in Kb and "mmm" the starting address for the buffer. The minimum buffer size is 16Kb, and the maximum size is the size of extended memory, but limited to 8192Kb by EMS specifications. The default is all extended memory not already used by any RAM disk drivers. The default starting address is 1024Kb or the first location available after installation of any RAM disk drivers.

To confirm that the statement is correctly written to the file, enter:

```
type config.sys
```

The information displayed should be identical to the statement you just put in the CONFIG.SYS file, otherwise repeat the process and create CONFIG.SYS again.

2. Make sure that the diskette/fixed disk on which you just created the CONFIG.SYS file can start the system and also that it contains the file EMM.SYS. Restart MS-DOS by pressing the three keys, Ctrl-Alt-Del, together. If you are using sub-directories on your hard (fixed) disk, be sure that config.sys and emm.sys are in the default directory.

3. If the EMM driver disk is successfully installed, the screen will display a message similar to this :

Extended Memory Manager - Reversion X

(C) Copyright 1986

EMM : Memory used = 256 KB (16 pages), at 1024 KB

For more information on EMM, please refer to the EMM.SYS program in the manual *Supplement to the MS-DOS Operating System User's Guide*.

THE INSTALL PROGRAM

The installation program on system diskette 2 creates or modifies the files CONFIG.SYS and AUTOEXEC.BAT on the disk with which you use to start the machine (system disk).

If the CONFIG.SYS and AUTOEXEC.BAT files do not exist on the system disk, they are created after running this program. If the system disk contains these two files, they will be modified accordingly to reflect the parameters you enter at the time of running INSTALL.

To start the program, enter :

install

You will see the main menu of the program :

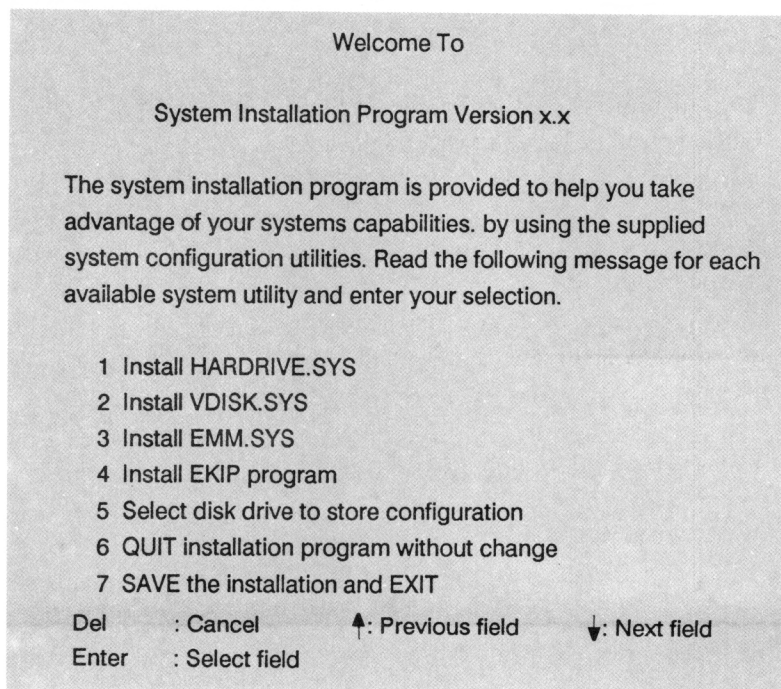

Use the cursor keys (either on the numeric key pad or cursor pad) to move the cursor up or down to the field you wish to select and press the Enter key. An asterisk is displayed at the left side of a field to indicate that this particular field is selected, or that the device driver had been specified in the CONFIG.SYS or AUTOEXEC.BAT file before you started the INSTALL program.

After selecting a field, if you decide to abandon the selection, move the cursor to this field and press the Del key. The asterisk will disappear after you press Del, indicating that the device driver has been canceled.

INSTALL HARDRIVE.SYS

Selecting the first field, Install HARDRIVE.SYS, displays the following message on the screen :

** Screen message for HARDRIVE.SYS system utility :

The HARDRIVE.SYS system utility enables your system to handle up to four fixed disk partitions on a physical fixed drive as logical drives, with the limitation that each partition size is no more than 32 Mb. The installation procedure will create/modify the CONFIG.SYS file and copy HARDRIVE.SYS to the system disk you specified.

Press any key to return to main menu

See the command "HARDRIVE" in the *Supplement to the MS-DOS Operating System User's Guide* for explanation and usage of HARDRIVE.SYS.

INSTALL VDISK.SYS

Selecting the second field, Install VDISK.SYS, displays the following message :

** Screen message for VDISK.SYS system utility :

The VDISK.SYS system utility enables your system to use a portion of memory as a logical disk drive. All data stored on a RAM disk will disappear after power off. If you have installed a VDISK.SYS system utility, you must copy all files from RAM disk to a physical disk before turning off the system. VDISK.SYS supports memory above 1 MB (extension memory) and memory below 640 KB (conventional memory). The installation procedure will create/modify CONFIG.SYS file and copy VDISK.SYS to the system disk you specified.

	RAM disk size(KB)	sector size	directory entries	Memory location	Transfer size
RAM disk #1	64KB	128	64	extension	8
RAM disk #2					

Esc : Abort and return → : Next Item ← : Previous item
End : Save and return ↑ : Previous field ↓ : Next field
Enter : Change value

You need to enter five parameters to install a virtual disk.

1. A virtual disk can be as large as the installed memory but no less than 64Kb which is the minimum memory allowed.
2. The sector size can be 128, 256 or 512 bytes.
3. The directory entries should be a multiple of 4, e.g., 4, 8, 12, 16, 64, etc.
4. The memory location can be *base* (conventional), or *extension*. Base memory is located within the first 640Kb of memory. Extension memory is located after 1 Mb.
5. The transfer size can be any value from 1 through 8 which is the maximum number of sectors of data the virtual disk transfers at a time.

The program supports up to two RAM disks. If you need to install a second virtual disk, move the cursor to RAM disk #2 and type the parameters for virtual disk size, sector size, and directory entries.

For more information on VDISK.SYS, please read the manual *Supplement to the MS-DOS Operating System User's Guide*.

INSTALL EMM.SYS

Selecting the 3rd field, Install EMM.SYS, displays the following message :

** Screen message for EMM.SYS system utility:

EMM.SYS (Extended Memory Manager) system utility provides memory management of memory over 1 Mb. It provides the same interface as EMS to enable packages to have more working data space to improve system performance. The installation procedure will create/modify the CONFIG.SYS file on and copy EMM.SYS to the system disk you specified.

Buffer size (KB)	: 16
Buffer starting address	: 1024
Initialization message	: on
Execution error message	: on
Transfer size (KB)	: 16

Esc	: Abort and return	↑	: Previous field	↓	: Next field
End	: Save and return	Enter	: Change value		

EMM.SYS is an expanded memory simulator. It manages ordinary extended memory in the 1 to 16 megabyte address range according to the Lotus / Intel / Microsoft Expanded Memory Specification (EMS). For complete details on the usage of EMM.SYS, please read the section "EMM.SYS" in the manual *Supplement to the MS-DOS Operating System User's Guide*.

INSTALL EKIP PROGRAM

Selecting field 4, Install EKIP Program, displays the following message :

** EKIP Europe Keyboard Interrupt service program installation screen:

EKIP installation procedure enables the system to run one of five European keyboard drivers as default when system is initialized. This function is the same as invoking SELECT.COM on the system diskette with the difference that SELECT.COM will destroy any previous CONFIG.SYS and AUTOEXEC.BAT files on the target diskette. EKIP will modify/create these two files. You may use SELECT.COM before this function, but not after, or you will lose the previous configuration for HARDRIVE.SYS, VDISK.SYS and EMM.SYS. After installation of EKIP and restart, the system will accept your EKIP assignment and treat it as the default keyboard driver. To switch from an EKIP to U.S. keyboard, just press F1 while holding down CTRL and ALT; to switch from U.S. keyboard to an EKIP keyboard, press F2 while holding down CTRL and ALT keys.

United Kingdom
Spain

Germany
Italy

France

Esc : Abort and return →: Next Item ←: Previous item
Enter : Save and return Enter: Select

After you press Enter, an asterisk will appear at the left side of the selected item. "EKIP" is the acronym for European Keyboard Interface Program. It loads a non-U.S. English keyboard into memory, so that the original U.S. keyboard program is replaced by it. This enables you to enter European symbols and special characters from the keyboard.

SELECT DISK DRIVE TO STORE CONFIGURATION

If you want the installation information of the above system utilities to be stored in the default drive, skip field 5 and select field 7. If you wish to save the information in another drive, select the 5th field. For instance, if the default drive is C and you want to save the installation in drive A, enter **5**, you will see this message on the screen :

```
Current disk drive is C:  
Enter new disk drive name (a,b,c...),  
or press Esc to exit
```

Type **A** . The drive name "C" in the message will be replaced by "A", indicating that current drive has changed to drive A. To return to the main menu, press the Esc key.

SAVE THE INSTALLATION AND EXIT

After selecting the 7th field, you will see the following menu:

```
HARDRIVE.SYS
KEYBOARD DRIVER      = xxx
EMM :
    BUFFER SIZE      = xxx
    STARTING         = xxx
    INITIALIZATION   = xxx
    EXECUTION        = xxx
    TRANSFER SIZE    = xxx

VDISK:
    RAM DISK #1 : RAM DISK SIZE      = xxx
                : SECTOR SIZE        = xxx
                : DIRECTORY ENTRIES = xxx
                : MEMORY LOCATION    = xxx
                : TRANSFER SIZE      = xxx
    RAM DISK #2 : RAM DISK SIZE      = xxx
                : SECTOR SIZE        = xxx
                : DIRECTORY ENTRIES = xxx
                : MEMORY LOCATION    = xxx
                : TRANSFER SIZE      = xxx
```

PRESS ENTER TO SAVE CONFIGURATION AND EXIT,
OR PRESS ANY OTHER KEY TO RETURN TO MAIN MENU

"xxx" is the value you enter. For example, in the "KEYBOARD DRIVER" field it could be one of the supported countries - United Kingdom, Germany, Spain, Italy or France.

Now check that the parameters for all the fields have been correctly entered. If you are satisfied, press the Enter key to save the fields. Remember that doing so will cause the relevant contents of the CONFIG.SYS and AUTOEXEC.BAT files in the current drive to be overwritten.

If any of the selected utilities are not found either in the default or the current drive, you will see this message :

```
** CAN'T FIND XXXXXXXX.XXX, YYYYYYYY.YYY...  
PRESS ANY KEY TO RETURN TO MAIN MENU
```

"XXXXXXXX.XXX, YYYYYYYY.YYY..." are filenames of the absent utilities. The INSTALL program can't copy anything to the current drive, although it has created/modified the CONFIG.SYS and the AUTOEXEC.BAT files in the default drive. You should copy the missing utilities to the current diskette so that the installations you just made in the INSTALL program will take effect.

If you do not wish to save the parameters, do not press the ENTER key but any other key to return to the main menu and type the correct parameters again. If you decide to abandon the installations you just made, select the 6th field to exit from the INSTALL program.

THE SYSENV PROGRAM

The SYSENV.COM utility resides on system diskette 2. You can use this program to examine or change the CPU operating speed, the residence of BIOS, and the memory mode of your system. To start SYSENV, enter :

`sysenv`

The following messages may be displayed on the screen :

```
SYStem ENVironment Set/Read Utility Version x.xx  
usage: sysenv [smart|16M|12M|10M|8M|6M|PC|rom|ram]  
RAM BIOS active  
Current system operation speed is SMART  
Default memory mode: 4  
Current memory mode: 4
```

This shows that in your system, CPU accesses RAM BIOS, the current CPU operating speed is SMART (16MHz and automatically shifts to other speeds when necessary), the default memory mode is set to Mode 4, and the current memory is also Mode 4.

CHANGING BIOS ACCESS LOCATION AND MEMORY MODE

To change the BIOS access location from RAM BIOS to ROM BIOS, enter :

sysenv rom

Enter **sysenv** again to confirm that BIOS access location has changed to ROM BIOS. You should see these messages :

```
SYStem ENVironment Set/Read Utility Version x.xx  
usage: sysenv [smart|16M|12M|10M|8M|6M|PC|rom|ram]  
ROM BIOS active  
Current system operation speed is SMART  
Default memory mode: 4  
Current memory mode: 3
```

Note that in the messages the current memory mode is also changed from Mode 4 to Mode 3 while the default remains

Mode 4. You cannot change the default memory mode by using the SYSENV program. To do that, you should reset the DIP switches on the mother board.

For more information on system memory modes, please refer to Appendix A of this manual *On-Board Switch Setting*.

CHANGING CPU OPERATING SPEED

To change the speed to another mode, say PC (4.77MHz), enter :

`sysenv pc`

After you press Enter, the speed mode is changed to PC. To confirm this, enter `sysenv` again. The following messages should be displayed :

```
SYSTEM ENVIRONMENT Set/Read Utility Version x.xx  
usage: sysenv [smart|16M|12M|10M|8M|6M|PC|rom|ram]  
ROM BIOS active  
Current system operation speed is PC  
Default memory mode: 4  
Current memory mode: 3
```

You can change CPU operating speed alternately between the default and the current speed by pressing the three keys, Ctrl-Alt-Plus(+ in the numeric keypad), together. Note that before you use SYSENV to set the current operating speed, pressing these three keys will cause the speed to shift back and forth between the default speed (Smart or 16MHz) and 8MHz. You can not change the default speed by using SYSENV. To do that, you have to reset SW1-6 on the 8-pin DIP switch.

For more information on CPU operating speeds, please refer to Appendix A of this manual *On-Board Switch Setting*.



APPENDIXES

APPENDIXES

A P P E N D I X A

ON-BOARD SWITCH SETTING

<i>Default DIP Switch Settings</i>	A-2
<i>SW1 (8 Bit DIP Switch)</i>	A-3
<i>Switch Settings For ROM BIOS Chip Type</i>	A-3
<i>Switch Setting For Display Type</i>	A-5
<i>Switch Setting For CPU Operating Speed</i>	A-6
<i>Operating Speed Indicator Light</i>	A-7
<i>Changing Speed without Adjusting SW1-6</i>	A-8
<i>SW1-7 And SW1-8</i>	A-8
<i>SW2 (4 Bit DIP Switch)</i>	A-9
<i>SW2-1 And SW2-2</i>	A-9
<i>SW2-3</i>	A-10
<i>SW2-4</i>	A-10
<i>Switch Settings For Memory Modes</i>	A-11
<i>On-Board Memory Mode Mapping</i>	A-12
<i>Memory Mode 1</i>	A-12
<i>Memory Mode 2</i>	A-13
<i>Memory Mode 3</i>	A-13
<i>Memory Mode 4</i>	A-13
<i>Memory Beyond 1MB</i>	A-14
<i>Changing Memory Mode</i>	
<i>With The SYSENV.COM Utility</i>	A-15
<i>System Memory Map</i>	A-16
<i>I/O Address Map</i>	A-17



There are two DIP (Dual In-Line Package), or block switches on the system board designated SW1 and SW2. SW1 has 8 slide switches and SW2 has 4. These slide switches can be set to ON or OFF by using the tip of a ball point pen or any other small pointed object.

The switches are used to configure the computer for the type of monitor you are using, the type of BIOS chip installed, the CPU operating speed, the memory mode used and the number of wait states.

The locations of SW1 and SW2 are shown in the following figure.

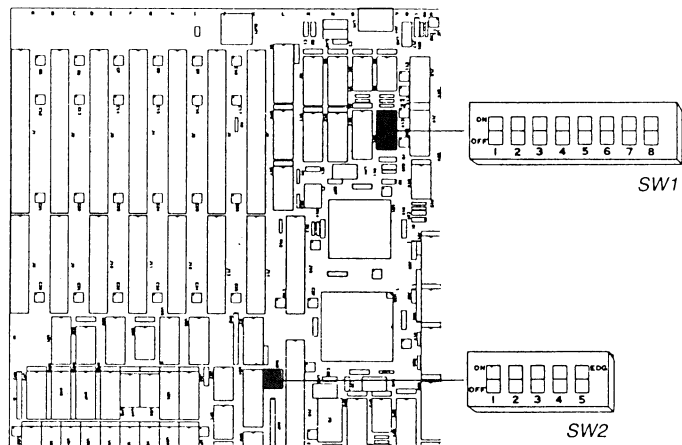

Locations of the DIP Switches

DEFAULT DIP SWITCH SETTINGS

Switch	ON/OFF	Description
SW1-1	ON	ROM chip type 27128
SW1-2	ON	
SW1-3	OFF	
SW1-4	OFF	
SW1-5	--	Depends on option
SW1-6	ON	Smart
SW1-7	OFF	Memory Mode 4
SW1-8	OFF	
SW2-1	ON	Memory Mode 4
SW2-2	ON	
SW2-3	ON	Zero wait
SW2-4	--	Reserved

Default DIP Switch Settings

To operate your system properly, the two DIP switches, SW1 and SW2, should be correctly set. The following sections provide instructions for setting these DIP switches.

SW 1 (8 BIT DIP SWITCH)

SWITCH SETTINGS FOR ROM BIOS CHIP TYPE

The first four switches of SW1, i.e., SW1-1 to SW1-4, are used to set the ROM BIOS chip type. The system board of your computer supports either a 27128 or 27256 ROM BIOS chip. The four switches have been properly set in the factory to match the chip type that your system uses (27128). If you change the ROM BIOS chip to a 27256 you will also have to reset the four switches. See the function table below for the proper switch settings..

	27128	27256
SW1-1	ON	OFF
SW1-2	ON	OFF
SW1-3	OFF	ON
SW1-4	OFF	ON

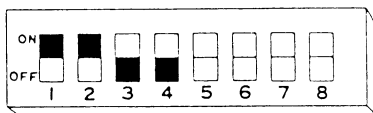

*Switch settings
for 27128 ROM BIOS*

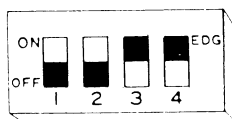

*Switch settings
for 27256 ROM BIOS*

SWITCH SETTING FOR DISPLAY TYPE

Your DELTAGOLD PREMIER comes standard with a MGC (Mono-Color Hercules Graphics Card) video adaptor. If your monitor is monochrome, set switch SW1-5 to OFF (default). Set it to ON if you have a color monitor.

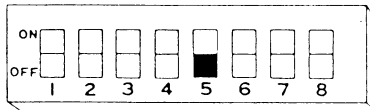

*Switch Setting for
Monochrome Video Monitor*

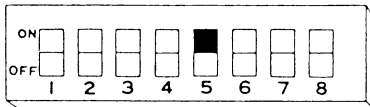

*Switch Setting for
Color/Graphics Video Monitor*

SWITCH SETTING FOR CPU OPERATING SPEED

SW1-6 is used to adjust the default CPU operating speed. Your system features the new 80386 microprocessor with an operating speed of 16MHz, two to four times faster than that of the 80286 used in IBM PC/AT. It is so fast that difficulty in accessing floppy diskette drives may occur with certain packages. To prevent this from happening, flip SW1-6 to ON to enter the Smart Mode. In this mode the 80386 will automatically change its operating speed while accessing floppy disks.

► NOTE

Some application software programs may have their own disk access routines. When you are running these application programs in the Smart mode, the floppy disk drives are under the control of these disk access routines. In this case, disk accessing is not controlled by the ROM-resident disk access routines and therefore the system will not slow down. As a result, the speed indication light remains on while running such application programs.

Your system has been set to be in the Smart Mode before shipping. If you want to set the default operating speed at 16MHz, flip SW1-6 to the OFF position.

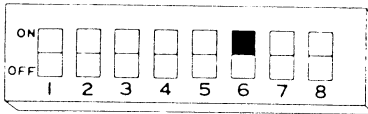

*Switch Setting for
Smart Mode*

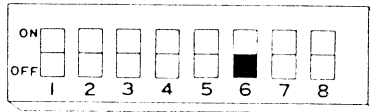

*Switch Setting for
16MHz Mode*

OPERATING SPEED INDICATOR LIGHT

When the system is operating at 16MHz, the indicator light labeled "16MHz/Smart" on the front panel comes on. This indicator light will go off when the system operates at 8MHz.

CHANGING SPEED WITHOUT ADJUSTING SW1-6

The default operating speed (either Smart or 16MHz) is set only by SW1-6. After power on, you can change the operating speed by using the SYSENV.COM utility. For detailed information on this utility, please refer to Chapter 5 of this manual.

SW1-7 AND SW1-8

There are 4 memory modes supported by the system board of your computer. The last two switches of SW1 (SW1-7 and SW1-8), together with another switch on SW2 (SW2-2) are used to set the memory. Detailed instructions on the effects of these settings on these memory modes are given later in this appendix.

	Mode1	Mode2	Mode3	Mode4
SW1-7	ON	ON	OFF	OFF
SW1-8	ON	OFF	ON	OFF

SW2 (4 BIT DIP SWITCH)

SW2-1 AND SW2-2

SW2-1 is reserved for future use.

SW2-2 is used to determine the memory mode of your system. Your system is shipped with an on-board memory of 1 Mb. Setting SW2-2 to ON indicates that the addresses of 640Kb of the memory are within 1Mb, while those of the remaining memory are beyond 1Mb. If all addresses of the whole memory are within 1Mb, set SW2-2 to the OFF position

	All within 1 Mb	640Kb within 1Mb the rest beyond 1Mb
SW2-2	OFF	ON

SW2-3

If SW2-3 is set to the ON position, the 80386 microprocessor will access memory with no wait states. If it is set to OFF (one-wait state), the 80386 will access memory at a speed slower than 16MHz. Your system is shipped with SW2-3 set to the ON position (zero-wait state). This won't cause any problems since the system board of your computer uses 100 n.s. RAM chips that will match the power of the 80386.

SW2-4

This switch is reserved for future use.

SWITCH SETTINGS FOR MEMORY MODES

Switch settings for the 4 memory modes are summarized in the table below.

	Mode 1	Mode 2	Mode 3	Mode 4
SW1-7	ON	ON	OFF	OFF
SW1-8	ON	OFF	ON	OFF
SW2-2	OFF	OFF	ON	ON

ON-BOARD MEMORY MODE MAPPING

Mappings for the 4 memory modes are shown below.

Address	Mode 1	Mode 2	Mode 3	Mode 4
100000			256K	256K
FFFFF				
E0000	ROM BIOS	RAM BIOS	ROM BIOS	RAM BIOS
A0000				
	640K	640K	640K	640K
00000				

MEMORY MODE 1

The mapping of Memory Mode 1 (see the above illustration) shows that ROM-resident BIOS is accessed by the system. 640Kb of the on-board memory (1Mb) is used by the operating system; the remaining 384Kb is reserved.

MEMORY MODE 2

The mapping of this memory mode shows that BIOS is transferred to RAM and can be accessed by the 80386 microprocessor much faster than in ROM, since memory is accessed 32-bits at a time in RAM but only 16-bits at a time in ROM.

The mapping also tells you that in addition to the 640Kb used by DOS, 128Kb of the on-board memory is used by BIOS (E0000-FFFFF). The remaining 256Kb is reserved.

MEMORY MODE 3

Memory Mode 3's mapping shows that BIOS is placed in ROM. 640Kb for DOS is located within 1Mb while 256Kb beyond 1Mb for other utilities. The remaining 128Kb is reserved.

MEMORY MODE 4

In this mapping, the 1Mb on-board memory is fully made use of. This mode differs from Mode 2 in that the reserved 256Kb in Mode 2 is used here. But this 256Kb is located beyond 1Mb.

► **NOTE** *For Memory Mode 1 and 2, the system BIOS tests only 640Kb. For Mode 3 and 4, the BIOS tests 896Kb (640Kb + 256Kb).*

If you want to plug a PC-AT Multi-function board or 32-bit memory expansion board into the unit, and your system memory is in Mode 1 or 2, you can adjust the starting address of the board at 1 Mb location. If your system memory is in Mode 3 or 4, then the starting address should be placed at 1280Kb (1024Kb + 256Kb).

MEMORY BEYOND 1MB

For Mode 3 and Mode 4, you may wonder how you can use the beyond-1Mb memory (256Kb) on your system board. As a matter of fact, under DOS, you can use this part of the memory to create *RAM disks* in which the microprocessor can access memory at faster speeds. In addition, you can treat it as *extended memory* for software packages like Lotus 1-2-3, Symphony, etc. EMM.SYS is the command or driver in MS-DOS which enables you to use the extended memory. For details on creating RAM disks or EMM, please refer to Chapter 5 of this manual.

► **NOTE** *The memory mode of your system is set to Mode 4 before shipping (default). You can use the SYSENV.COM program to check and/or reset your system memory mode.*

CHANGING MEMORY MODE WITH THE SYSENV.COM UTILITY

You can check or change your system memory mode with the SYSENV.COM utility without having to uncover the system unit and reset the switches. For information on the SYSENV.COM utility, please refer to Chapter 5 of this manual.

SYSTEM MEMORY MAP

Address	Name	Function
FFFFFF FE0000	128Kb System ROM	Select to the same ROM locations as 0E0000 - 0FFFFFF
FDFFFF 100000	Maximum memory 15Mb	I/O channel memory expansion option (100000 - 17FFFF built-in)
0FFFFF 0F0000	64Kb ROM	ROM on system board
0EFFFF 0E0000	64Kb ROM	Reserved on system board
0DFFFF 0C0000	128Kb I/O expansion ROM	Reserved for ROM on I/O adapters
0BFFFF 0A0000	128Kb Video RAM	Graphics display Buffer
09FFFF 000000	640Kb RAM memory	512/640Kb RAM built-in

I/O ADDRESS MAP

Hex Range	Device
000 - 01f	DMA controller-1 8237A-5
020 - 03F	Interrupt controller-1 8259A
040 - 05F	Timer 8254-2
060 - 06F	Keyboard controller 8041
070 - 07F	Real-time clock, NMI mask
080 - 09F	DMA page register
0A0 - 0BF	Interrupt controller-2 8259A
0C0 - 0DF	DMA controller-2 8237A-5
0F0 -	Clear Math Co-processor busy
0F1 -	Reset Math Co-processor
0F8 - 0FF	Math co-processor
1F0 - 1F8	Hard disk
200 - 207	Game I/O
278 - 27F	Parallel printer port 2
2F8 - 2FF	Serial port 2
300 - 31F	Prototype card
360 - 36F	Reserved
378 - 37F	Parallel printer port 1
380 - 38F	SDLC. Bisynchronous 2
3A0 - 3AF	SDLC. Bisynchronous 1
3B0 - 3BF	Monochrome display, printer adapter
3C0 - 3CF	Enhanced graphics adapter
3D0 - 3DF	Color/Graphics monitor adapter
3F0 - 3F7	Diskette controller
3F8 - 3FF	Serial port 1



A P P E N D I X B

FORMATTING THE HARD DISK

<i>Formatting Steps.....</i>	<i>B-2</i>
<i> SETUP Menu.....</i>	<i>B-2</i>
<i> Hard Disk Physical Format Menu.....</i>	<i>B-3</i>
<i> Defect Information.....</i>	<i>B-4</i>
<i> Formatting.....</i>	<i>B-5</i>
<i>Interleave.....</i>	<i>B-7</i>
<i> Interleave = 1.....</i>	<i>B-8</i>
<i> Interleave = 2.....</i>	<i>B-8</i>
<i> Interleave = 3.....</i>	<i>B-8</i>
<i>Shipzone.....</i>	<i>B-10</i>



A hard disk must be formatted physically and logically before it can be used. The physical format must be performed first. The option "HARD DISK FORMAT" in the SETUP program physically formats the hard disk.

► **WARNING**

Formatting your hard disk destroys all the data stored on it. This is why DELTAGOLD recommends you back up your hard disk on a regular basis. If your hard disk should suffer a "crash" and the need to reformat arises, you will loose all your files. Please back up your hard disk.

FORMATTING STEPS

Before proceeding to format your hard disk, you should correctly configure the system unit for memory size, display type, and number and type of disk drive(s).

SETUP MENU

When you enter :

setup

You should see this menu displayed :

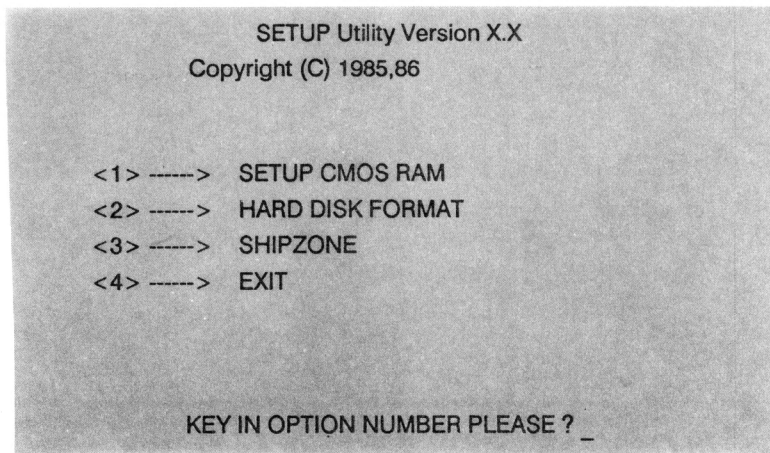

HARD DISK PHYSICAL FORMAT MENU

Type :

2

Press the Enter key.

The screen clears, and you see the hard disk physical format option menu :

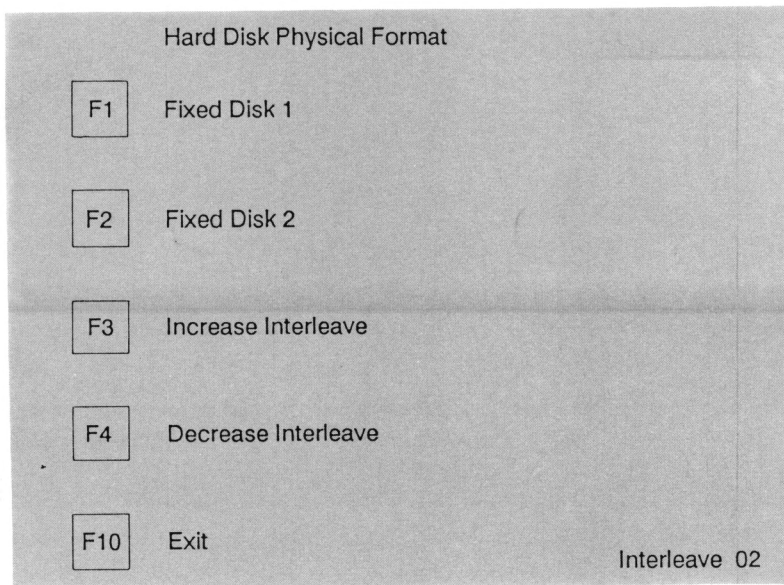

Press the F1 function key to format the first hard disk, which is referred to as drive C. If you have two hard disks, after physically formatting drive C, press the F2 function key to format the second hard disk, which is referred to as drive D.

DEFECT INFORMATION

Press F1; you will be prompted :

Do you want defect format (Y/N)?

Press Y(es). You will see the following picture with two blank boxes titled "Cylinder" and "Head" respectively :

Defect information Page 00

	Cylinder	Head
1.		
2.		
3.		
4.		
5.		
6.		
7.		
8.		
9.		
10.		
11.		
12.		
13.		
14.		
15.		

Cylinder range < 0 ...xxxxx Cylinder >
Head range < 0 ... xx Head >
Press <F10> --- Format
Press <ESC> --- Exit

► **NOTE**

The values for cylinder and head depend on the type of the hard disk drive. Refer to the Defect Information Table or Hard Error Map attached to the hard disk. This information should be typed into the above chart. The system will take note of these defective areas and not use them for storing data.

If there are more than 15 entries in the Defect Information of your hard disk you can press the PgDn key to scroll to the next page and enter additional defect entries.

FORMATTING

Press F10 and you will be prompted to start formatting the hard disk:

Formatting fixed disk drive n
This operation will destroy any data on the fixed disk drive
Are you ready (Y/N) ?

"n" is the fixed disk drive number to be formatted.

If you had previously formatted your hard disk and have placed data on it, all the data will be destroyed if you press Y. To abort the program and return to the option menu, press N.

Press **Y** to begin formatting. The hard disk in-use light on the front panel will come on, and this message is displayed :

```
F9 --- Exit
Formatting .....
Head    00
Cylinder 00000
```

The values for "Head" and "Cylinder" will keep on incrementing quickly until the formatting process is completed. If you find the formatting speed exceptionally slow, you may have chosen an incorrect hard disk type number while configuring the system. Abort the formatting process, enter the setup program and choose the correct hard disk type number, then start the physical format again.

To abort the program and return to the menu, press the **F9** function key.

If you do not have a hard disk, or if it is not properly connected or installed, this error message will be displayed :

```
***** Fixed Disk Error ! *****
Please strike any key .....
```

Press any key to return to the hard disk physical format option menu. Check that the hard disk is properly installed and connected, then format it again.

► **WARNING** *If you need to disconnect or connect cables to properly install the hard disk, be sure to turn off the power input to the system before doing so.*

INTERLEAVE

In the hard disk physical format option menu, the default value for the interleave factor is 2. This value can be increased or decreased by pressing the function key F3 or F4 respectively.

The hard disk rotates at about 3600rpm, which is ten times the speed of a conventional diskette drive. Each track on the hard disk has 17 sectors. The trouble is that if the read/write head is to read every consecutive sector at this speed, there is the possibility that the read/write head can miss reading from or writing to a sector. This will cause the disk head to wait for the disk to rotate until the sector that it missed reading from or writing to is again accessible. This slows down disk input/output. Interleaving remedies the situation.

Each track on the fixed disk has 17 sectors. The sectors are numbered 1 to 17 and the disk read/write head processes the sectors sequentially. It begins with the first sector, and after processing the first sector, it then proceeds to the second sector. This continues until all the 17 sectors are read from or written to. The head then moves to the next track.

When the interleave factor is 2, every alternate sector is read from. Sector No.1 is the first to be read. The second to be read is sector No.3, the third one is sector No.5, and so forth. Sector No.2 will be the tenth to be read. This means that after processing nine sectors, the head will return to read sector No.2.

With interleaving, the possibility of missing a sector for reading/writing by the disk drive head is reduced, and thus improving the speed of disk input/output by as much as a factor of four.

INTERLEAVE = 1

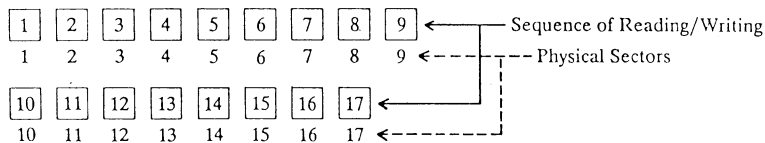

INTERLEAVE = 2

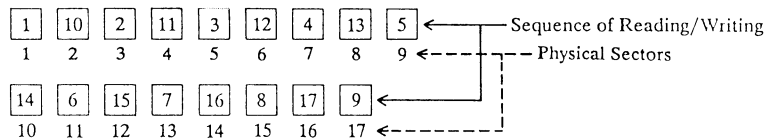

INTERLEAVE = 3

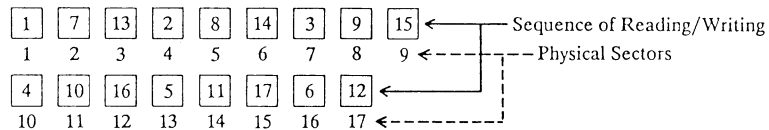

The valid value for the interleave factor can be any number within the range of 1 through 16. But having a greater interleave factor does not necessarily result in faster disk input/output. During tests it has been found that factors 2 and 3 produced the optimum disk access speeds. Using higher interleave factors in fact decreased the access speed.

Higher interleave factors mean greater distance between sectors. This will cause the read/write head to wait to read the next sector. The function of speed of disk access and interleave factor is also influenced by the manufacturer of the hard disk drive. If you have hard disk drives supplied by different manufacturers you can experiment with different interleave factors to find which value best suits your needs.

► **NOTE** *Most hard disk manufacturers have a suggested interleave. Reference your hard disk manual for the suggested interleave factor.*

After you have physically formatted your hard disk(s), press F10 to get back to the SETUP option menu. Press 4 to exit before you use the FDISK command on the first MS-DOS system diskette to create one or more DOS partitions on the hard disk. After you have used the FDISK command to create partition(s) on the hard disk, you must use the FORMAT command to logically format the hard disk. For details on the FDISK command, please refer to the manual *Supplement to the MS-DOS operating System User's Guide*.

SHIPZONE

Option 3 in the SETUP menu is the utility called "SHIPZONE" which positions the read/write head of the hard disk in a safe area so that the hard disk can be safely transported without damaging the stored data.

The distance between the disk read/write heads and the platters (disks on which data is stored) is infinitesimally small. When you move the system unit to a new place, shocks or strong vibration during transportation can cause the heads to rub against the platters and damage the stored data. To prevent this from happening, the heads of the hard disk drive are parked in a certain area so that the heads will not come in contact with the platters where data is stored.

► **NOTE** *It is recommended that you backup all the files in the hard disk before transporting the system and always use SHIPZONE before moving the unit.*

To start SHIPZONE, select option 3 in the SETUP menu. This message is displayed :

R/W HEAD IS POSITIONED ON SHIPPING ZONE NOW !
Strike any key to continue...

The hard disk is now ready for transportation. When you start the system again, the read/write heads will move themselves from safe to data area.

A P P E N D I X C

INSTALLING AN ADAPTER CARD

- 1) Turn off the power switch on the rear panel of the system unit.
- 2) Turn off all external power switches on the monitor, printer, and other peripherals that are attached to the system unit.
- 3) Disconnect the keyboard.
- 4) Disconnect all cables from the rear panel of the system unit, noting where each cable was connected.
- 5) Place the system unit in a convenient position to allow access to the rear panel.

- 6) Remove the five screws from the rear panel with a screwdriver as shown below. Save the screws to reinstall the top cover.

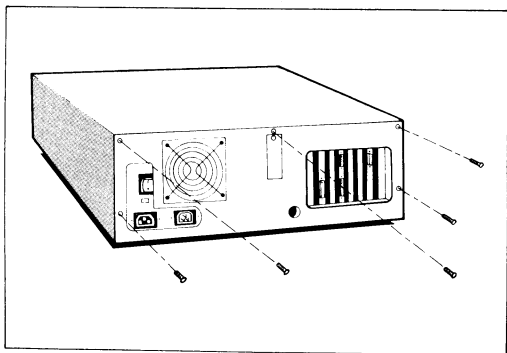

- 7) Carefully slide the system unit's top cover halfway towards the front as shown in the next figure. Then lift the cover a little. This should free the top cover from the bottom of the system unit. If the cover does not come free, rock it gently until the cover works itself free.

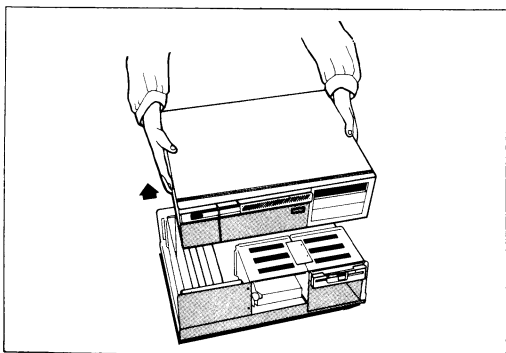

- 8) There are eight expansion slots on the upper left of the system board. Six of these slots are long slots; each of them actually consists of two slots : 62-pin + 32-pin connectors. The remaining two slots are short slots; each consisting of one 62-pin connector.

The adapter or expansion card is installed into one of these expansion slots. Check the adapter you intend to install to see whether it should fit in a long or short slot.

- 9) Remove the bracket from the blank expansion slot into which you wish to install the expansion card or adapter. Save the screw to hold the expansion card. Put away the bracket for future use.

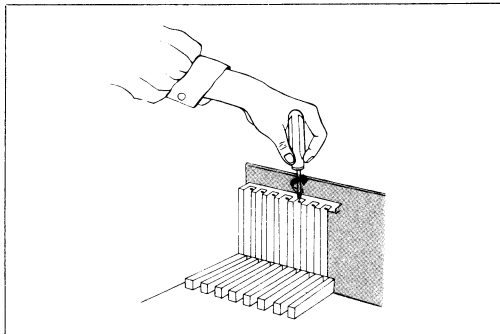

- 10) Refer to the adapter installation guide to check if any switches or jumpers need to be adjusted on the adapter. Make sure that the specified switches or jumpers are set as instructed.
- 11) With the component side of the adapter facing right, align it with the card guides before inserting the adapter into the slot by pressing on top. Do not exert excess force to seat the adapter. If necessary, rock it slowly into the slot. Fasten the adapter with the bracket screw.

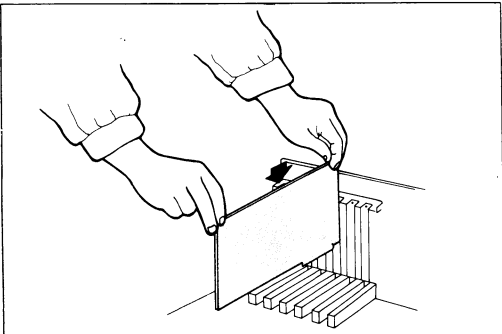

- 12) Check if you need to reconfigure the system with SETUP. For example, you will need to go through the configuration procedure if you change from monochrome to color or enhanced graphics adapter.
- 13) Before putting the top cover back on the system unit, remember to check that the wires and cables in the system unit are not pinched between the covers. Check also that the cables do not block any vent holes.
- 14) Put the top cover back on the system unit and secure it with the five back panel screws.
- 15) Reconnect the keyboard, monitor, printer, and other peripherals to the system unit.
- 16) Connect the power cables of the system unit and peripherals to power outlets.



A P P E N D I X D

JUMPER SETTING

<i>Co-processor Jumper Setting</i>	D-1
<i>Install Power Connector</i>	D-2
<i>Battery Connector</i>	D-3
<i>J23 Pin-Out</i>	D-4



CO-PROCESSOR JUMPER SETTING.

There are three co-processor jumpers located on J20, J21 and J22. Set these jumpers according to the following tables :

reserved	1 - 2
387	1 - 2
None	2 - 3

Jumper Setting for J20 and J21

reserved	1 - 2
387	2 - 3
None	1 - 2

Jumper Setting for J22

INSTALL POWER CONNECTOR

The power connector is located on J18 and J19. The pin functions are as follows:

<u>Pin No.</u>	<u>Description</u>
J18	1 Power good
	2 +5V
	3 +12V
	4 -12V
	5 Ground
	6 Ground
J19	1 Ground
	2 Ground
	3 -5V
	4 +5V
	5 +5V
	6 +5V

BATTERY CONNECTOR

The battery connector is located on J17. The pin functions are as given below :

<u>Pin No.</u>	<u>Description</u>
1	6V
3	Ground
4	Ground

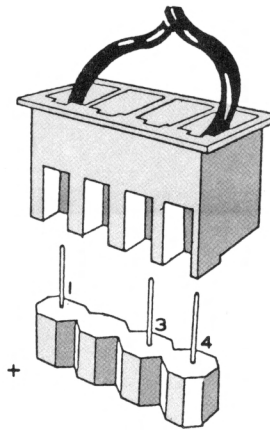

J23 PIN-OUT

<u>Pin No.</u>	<u>Description</u>
1	Reset
2	Speed
3	
4	Ground
5	KB Lock
6	Ground

A P P E N D I X E

SYSTEM SPECIFICATIONS

	STANDARD	OPTIONAL
CPU	Intel 80386	
CPU SPEED	Smart (default) 16MHz AT 12MHz AT 10MHz AT 8MHz AT 6MHz AT PC	
CO-PROCESSOR	Intel 80387	
ON-BOARD RAM	1Mb	
ON-BOARD ROM	32Kb	
EXPANSION SLOTS	1 32-bit slot 2 PC/XT slots 5 PC/AT slots	
STORAGE SPACE FOR DISK DRIVES	5.25" x 5	
HARD DISK DRIVE		5.25" 40Mb x 1
FLOPPY DISK DRIVE	5.25" 1.2Mb x 1	5.25" 1.2Mb x 1
POWER SUPPLY	196-Watts	
KEYBOARD	DGK-200	



A P P E N D I X F

THE L.C.D. CLOCK

<i>Changing The Display.....</i>	<i>F-2</i>
<i>To Display Date.....</i>	<i>F-2</i>
<i>To Display Seconds.....</i>	<i>F-2</i>
<i>To Alternate Time/Date Display.....</i>	<i>F-2</i>
<i>Setting The L.C.D. Clock.....</i>	<i>F-3</i>



Your DELTAGOLD Computer comes equipped with an L.C.D. clock. This clock is powered by a battery and runs independent of the system. The battery should last over 1 year and is user replaceable.

CHANGING THE DISPLAY

The L.C.D. clock has 2 buttons. The top button is used to change the display from TIME to DATE to SECONDS. To change the display simply follow the instructions listed below.

TO DISPLAY DATE

Press the top button once. The date will display for 2 seconds.

TO DISPLAY SECONDS

Press the top button twice. The seconds will be displayed. To return to the time display press the top button again.

TO ALTERNATE TIME/DATE DISPLAY

Press the bottom button once (while the clock is in the time display). To return to the time display, press the top button twice.

SETTING THE L.C.D. CLOCK

1. To set the month on the L.C.D. clock press the bottom button twice (while in the time display). This will display the month. Press the top button until the desired month is displayed.
2. To set the date press the bottom button again. This will display the date. Press the top button until the desired date is displayed.
3. To set the time press the bottom button again. This will display the hour and will designate A.M. by displaying an "A" at the right side of the display, and P.M. by displaying a "P" on the right side of the display. Press the top button until the desired hour is displayed.

► **NOTE** *Please take notice of the P.M. and A.M. designations on the clock. If you do not set the time properly, your clock will not maintain the date properly.*

4. To set the minutes press the bottom button again. This will display the minutes. Press the top button until the desired minutes are displayed.
5. Press the bottom button again to set the time.
6. Press the top button to start the clock.

Your L.C.D. clock is now set. If you wish to change only one portion of the clock, for example hours, you should press the bottom button (from the time display) until you see hours on the display. Now press the top button until the desired hour is displayed. Press the bottom button until the full time appears on the display. If the "colon" is flashing then the clock is on. If the "colon" is not flashing, press the top button.

A P P E N D I X G

THE DGI-EGA CARD

<i>Switch And Jumper Setting</i>	G-2
<i>Direct Drive Connector</i>	G-4
<i>Light Pen Connector</i>	G-5



The DGI-EGA Card is an enhanced graphics controller having more versatilities than most other video cards such as the Color/Graphics Adapter and the Monochrome Display Adapter.

With the DGI-EGA Card, you can connect color or monochrome direct drive display monitor for your system. In addition, a light pen interface is also provided.

The resolutions for graphic modes supported by the DGI-EGA are as follows:

- * 640 (v) x 350 (h) dots for the Enhanced Color Display.
- * 640 (v) x 350 (h) dots for the Monochrome Display.
- * 640 (v) x 200 (h) and 320 (v) x 200 (h) dots for the Color Display.

SWITCH AND JUMPER SETTING

Because the DGI-EGA supports both color and direct drive monitors in a variety of modes, so you have to set the adapter switches to indicate the resolution to be used and whether a color or a monochrome display monitor is to be used.

There are two 3-pin jumpers and one block switch on the card. The switch is marked "SW" and is located on the upper-right edge of the adapter. The jumpers are labelled "JP3" and "JP4" on the adapter. The card is shown below:

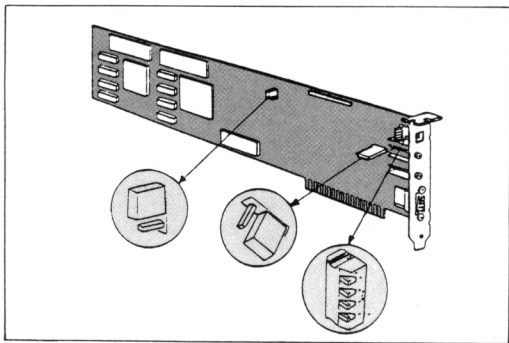

DGI-EGA Card

Set the switches and jumpers according to the following table:

SW-1	SW-2	SW-3	SW-4	MODE
ON	OFF	OFF	ON	Color Display 40x25
OFF	OFF	OFF	ON	Color Display 80x25
ON	ON	ON	OFF	EGA Emulation Mode
OFF	ON	ON	OFF	EGA Hi-Res Mode
OFF	OFF	ON	OFF	Monochrome

Display Connected To The Enhanced Graphics Adapter	Jumpers	
	JP3	JP4
Enhanced Color Display	2 & 3	1 & 2
Monochrome or Color Display	2 & 3	2 & 3

Switch And Jumper Setting

DIRECT DRIVE CONNECTOR

The pin configuration and signal assignments of the direct drive connector of the DGI-EGA Card is shown below:

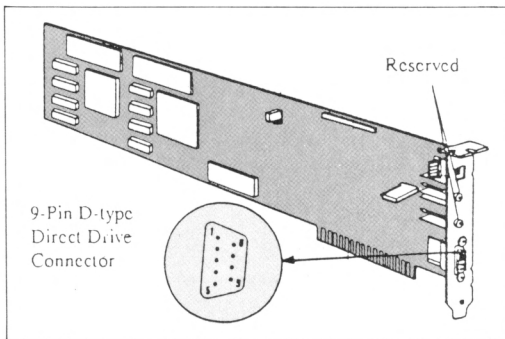

Pin No.	Signal	Pin No.
1	Ground	1
2	Secondary Red	2
3	Primary Red	3
4	Primary Green	4
5	Primary Blue	5
6	Secondary Green	6
7	Secondary Blue	7
8	Horizontal Retrace	8
9	Vertical Retrace	9

Display Monitor

Enhanced Graphics Adapter

LIGHT PEN CONNECTOR

The pin configuration and signal assignments of the light pen connector of the DGI-EGA Card is shown below:

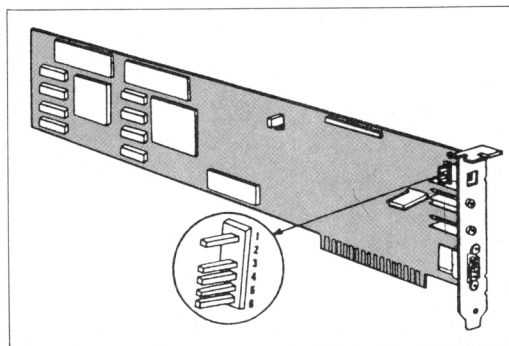

Pin No.	Signal	Pin No.
1	+ Light Pen Input	1
2	Unused	2
3	+ Light Pen Switch	3
4	Ground	4
5	+5 Volts	5
6	12 Volts	6

Light Pen Attachment

Enhanced Graphics Adapter





GLOSSARY



G L O S S A R Y

80386 Is the name of the microprocessor which is the brain of the DELTAGOLD PREMIER computer. The 80386 can access 4 Gigabytes. 1 giga is 1 billion.

80387 Is the name of the math coprocessor which can be optionally used in parallel with the 80386 for faster numerical processing.

ADAPTER Also called *interface card*, is an *add-on card* designed to fit into an expansion slot to enhance the processing power of the computer. It is also used for communicating with other kinds of devices. Some adapters are enhanced graphics, printer, asynchronous communications and memory adapters.

ADDRESS When used as a noun, it is a value or label identifying a specific memory location. Addresses are assigned to the accessible memory locations so that data can be read from (retrieved) or

written to. The 80386 CPU has 4 gigabytes of addressing capability, or 4 gigabytes of unique addresses, starting with 0 and incremented by 1 for each successive address.

When "address" is used as a verb, it means to reference a specific memory location.

ADDRESS SPACE A range of memory locations occupied by a program. Also the complete range of memory locations that can be accessed by a microprocessor. The address space of 80386 is 4 billion memory locations.

ASCII American Standard Code for Information Interchange (also called USASCII). A standard 8-bit information coding system that assigns a number from 0 to 127 to each of 128 upper and lowercase letters of the English language, numbers, special characters, and control characters. It is used widely with most computers and terminals and can be transmitted from one location to another in parallel or serial format.

ASSEMBLY LANGUAGE

structure of this programming language is similar to that of machine language, but is less prone to coding errors. Programs written in assembly language consist of mnemonics and meaningful words instead of machine codes that are consisted of only 1s or 0s, thus are more readable. An assembly language programmer has complete control over the microprocessor, while a programmer of high level languages, like *BASIC*, *COBOL*, etc. can only use provided features. A program written in assembly language will run faster than any program written in high-level programming languages.

ASYNCHRONOUS COMMUNICATIONS

Also called *Serial Communications*, is a type of data transmission not based on synchronized timing. 'Asynchronous' means that the transmission of data can occur anytime.

ATTRIBUTE A property or characteristic that is supported in an output, display, or data.

BINARY A numerical system using only the two symbols "0" and "1". Inside all computers, binary arithmetic operations are used for quick computing.

BIOS An acronym for Basic Input Output System. These are a collection of primitive computer routines, usually burnt into ROM, to control the video display, disk drives, keyboard, etc.

BIT It is a binary digit and the most basic unit of data that can be recognized and processed by a computer. A bit is either 0 or 1. Bits can be grouped to form larger units of information - nibble, byte, word.

BOOTSTRAP (BOOT) To load an operating system from a "cold" reset cycle. This term was derived from the sense that the computer intends to get itself started by pulling its bootstraps.

BUFFER An area in memory in which data is to be stored temporarily to facilitate output or processing later.

BUG An error. A hardware bug is an electrical, mechanical, or electronic defect that interferes with the normal operation of a computer. A software bug is an error in a program.

BUS A group of wires or conductive strips of metal used to transmit a set of related signals or information within a computer from one device to another.

BYTE A number of contiguous bits forming a character. It is a basic unit of information that is stored or processed by the computer. In some computers, a byte consists of seven bits, but in modern microcomputers a byte is usually made up of eight bits. A byte that consists of eight bits can represent or hold a value from 0 to 255. Each character in the ASCII character set can be represented by one byte.

CALL A call is an instruction to transfer control to a specified subroutine from the main program or current subroutine. A program consists of a main program and subroutines. After the execution of the called subroutine, it will

return control to the main program or calling subroutine.

CHARACTER A symbol found on the key of a computer keyboard. The symbols include the decimals 0 to 9, the letters A through Z, punctuation marks, control characters or other special signs the computer can read, write, and process. Most control characters such as line feed, and carriage return cannot be printed or be shown on the display screen.

CHIP The common term for an integrated circuit. This is a piece of square silicon on which electronic circuits are etched on a thin metal oxide film.

CMOS Acronym for Complementary Metal Oxide Semiconductor.

COLD-START Also called cold boot or cold reset. To turn on the power switch of a computer to begin its operation. If the computer is already on, to turn off the power switch and then to turn it on again. After a cold start all the devices of the computer are reinitialized.

COLOR BURST The signal that color TV recognizes and converts to the color dots which are then displayed on the TV screen. Without the color burst signal, all pictures would be black-and-white.

COMPUTER Any device that can receive and store a set of logic and arithmetic instructions and information for processing in a predetermined and predictable way.

CONTROL CHARACTERS

Are characters in the ASCII code set which have no graphic representation, and thus can not be seen on the screen. These characters are used for various control functions. *Form Feed* and *Line Feed* are control characters to name a couple.

CPU Central Processing Unit.

CRT Cathode ray tube. Usually used to describe any video display device that has a TV screen.

CURSOR A special symbol on the screen which shows the position where a character will be displayed when keyed in.

CYLINDER A hard disk is made up of platters. On the surface of each platter are concentric circles called tracks. The tracks on a platter are identified with unique numbers starting from 0. Tracks of the same number from all the platters constitute the cylinder of that same number. Thus "cylinder 5" refers to all tracks numbered "5" on the platters.

DATA Information of any type, including binary data, hexadecimal numbers, integer, string of characters, ASCII characters, etc.

DEBUG To find and correct errors in a program or hardware.

DEFAULT For most commands, there are optional parameters that you can type to make the command work in a specific way. *Default* is the response that a program will assume unless a response is specified by the user.

DIP Dual in line package. It is the most popular packaging method for integrated circuits. It has two parallel rows of

pins. The numbers of pins usually come in 14, 16, 18, 20, 24, 40, or more.

DISK There are several kinds of disks. Floppy and hard disks are the most common. Disks are used to store information outside of the main memory of the computer. Floppy disks or diskettes come enclosed in a jacket with part of it exposed for the drive head to read or write; it is called floppy because it is soft. Hard or fixed disks are so called because the media is made of metal and cannot be removed from the disk drive.

DISK DRIVE Is the device incorporating the mechanism to write and read information on a disk or diskette.

DISPLAY As a noun, denotes that part of any device that presents signals in visual form. Usually, the video display is a video monitor or a TV screen.

DOS The acronym for Disk Operating System. It is a set of programs stored on a disk to enable you to control the computer components. It con-

trols functions such as displaying, reading/writing to a disk, printing, accepting commands from the keyboard, etc.

EDGE CONNECTOR A connector made of strips of brass, or other conductive metal, found at the edge of a printed circuit board. It is designed for plugging into a socket of another circuit board to exchange electronic signals.

EMM The acronym for Expanded Memory Manager that meets the Lotus/Intel/Microsoft Expanded Memory Specification. This is a software and hardware support for RAM installed after the first megabyte in the computer system. Up to 16MB of memory is supported.

EXPANSION SLOT On the system board there are several long, narrow connectors into which adapters or add-on cards can be inserted to expand or enhance the functions of the computer.

FIELD An item from a set of related items, such as those in a record.

FORMAT 1) A preset or pre-determined method of arranging characters, lines, punctuations, etc. 2) The physical organization or arrangement of a disk. 3) As a verb, to specify the form of a format.

HARDWARE Refers to the physical components of a computer.

HIGH-LEVEL LANGUAGE A kind of computer programming language that resembles English. *BASIC*, *C*, *COBOL*, *FORTRAN*, and *Pascal* are some common high level languages.

HZ Hertz, or cycles per second which is a measurement unit of frequency. In the *DELTA GOLD PREMIER* the 80386 is designed to operate at 16 MHz.

I/O See *Input/Output*.

INPUT As a noun, data which flows from external devices to a computer. As a verb, to send data from external components to the computer's internal memory.

INPUT/OUTPUT The process of transferring data between the computer and external devices.

INTEGRATED CIRCUIT A small, thin silicon wafer into which complicated electronic circuitry has been etched. A single IC can hold from ten to ten thousand discrete electronic components. These ICs are usually packaged in DIP.

INTERFACE An exchange of information between one device and another, or the device that makes such exchange possible.

K Stands for the Greek prefix "kilo", meaning one thousand. In computer usage, it means 2 to the power of 10, or 1,024.

KILOBYTE It is a measure of computer memory equivalent to 1024 bytes. It is also written as KB.

LANGUAGE computer language is a set of codes or instructions, with specific rules and syntax, use for writing programs that instruct computers on how to process data into information.

LOW-LEVEL LANGUAGE A fundamental computer language whose structure is suitable for the computer to recognize and process. Assembly and machine languages are low level languages. Contrasted with high level languages whose structures resemble English.

MEGABYTE It is a measure of computer memory equivalent to 1,048,576 bytes. It is also written as MB.

MEMORY ADDRESS A unique value assigned to a memory location. The address of a memory location may be expressed in hexadecimal or decimal. The 80386 has 4 billion addressable memory locations.

MEMORY LOCATION In the 80386, it is any one of the addressable 4 billion locations. A memory location corresponds to a unique address and can be filled with a specific value.

MEMORY MAP A listing that shows the entry point and the block of memory that is being occupied by a program. It is

also used as a reference to find the storage locations and amount of memory that is being used by the stack, data, and code segments of a program.

MICROCOMPUTER A small computer that uses a microprocessor as its central processing unit.

MICROPROCESSOR An IC or integrated circuit that controls and executes machine language instructions for directing the various components of the computer in processing data.

MODE A condition or set of conditions under which a set of rules apply.

OPERATING SYSTEM A set of programs that resides in ROM and/or diskette that performs the frequently needed input/output procedures.

OUTPUT As a noun: 1) The data generated by the computer and then transferred to an external device. 2) The signals which are generated from

one or a set of input signals to an IC. As a verb, the process of generating such data.

PAGE 1) A unit of measurement for the quantity of memory that can be independently displayed and written to. 2) A full screen of information on a video display. 3) A block of memory treated as a single unit.

PARALLEL PRINTER A type of printer that processes 8-bit or 1 byte at a time. Almost all printers used on personal computers are parallel printers.

PARALLEL TRANSMISSION A way of sending data between devices by sending bits simultaneously through separate wires. This is faster than a serial connection.

PARAMETER A value or alphabetic input which is needed to process a command or program in a specific way. The parameter can be changed to control the functions of a command or program.

PARTITION A hard or fixed disk has enormous storage capacity and can be installed with more than one operating system for controlling the computer system. The hard disk must first be partitioned, and each partition is installed with a different operating system. *FDISK* is the MS-DOS command used to partition a hard disk.

PC BOARD *See Printed Circuit Board.*

PERIPHERAL An I/O device that is under the control of the microprocessor. It services some of the I/O needs of a microcomputer system. Most peripherals are input and/or output devices, such as, cassette recorder, video monitor, diskette drive, printer, and others.

PERSONAL COMPUTER A common term for a microcomputer. Usually refers to small computers which are suitable for use by one user at home, office, or school.

PORT It is the channel or interface between the micro-

processor and external devices. The disk drive, for example, is connected to one of the 65,536 ports that are supported by 80386.

PRINTED CIRCUIT BOARD

A board of fiberglass or epoxy on which a thin layer of metal has been applied. This film of metal is then etched to form traces. Electronic components can be attached to the traces for exchanging signals. Small PC boards are usually called cards.

PROGRAM A sequence of instructions written to direct the computer to perform a specific function or task.

PROMPT A special symbol to indicate the beginning of an input line. It is also a message that appears on the screen indicating to user that certain action has to be taken.

RAM Random Access Memory is an IC for read/write memory, to and from which data can be written and retrieved. The contents of RAM will be lost as soon as the power is turned off.

RAM BIOS BIOS transferred to RAM from ROM for faster system operation.

RAM DISKS Also called disk emulators or virtual disks. A process can be done wherein a portion of the computer memory will reserved for use as a disk drive. Instead of saving information on a physical disk, the information is saved in RAM or computer memory. RAM disks operations are fast compared to physical disk drives, but when power is turned off, all information is lost.

READ/WRITE HEAD The magnetic head with which information is written to or read from a disk.

ROM Read Only Memory is an IC memory storage device, in which data is stored permanently and can not be altered. The data in ROM remains intact even when the power is turned off. ROMs are usually used to store programs that have to be resident in the computer, such as the monitor program.

RUN Execute a computer program.

SCROLL To move the text up or down a video screen.

SECTOR A disk media on which information is written or read from is divided into sectors and tracks. Track are concentric circles on a disk, which are further divided into sectors. A sector usually holds 512 bytes of information. A single-sided disk will have tracks written on one side; and a double-sided disk will have tracks written on both sides of the disk.

SERIAL PRINTER A printer type that requires serial communications to work. Serial communications sends data one bit at a time.

SOFTWARE Programs, such as assembler, compiler, operating system, electronic spread sheets, word processor, etc. that instruct the hardware to perform a particular task. It is the intangible logic system in a computer. Contrast with *Hardware*.

SYNTAX The rules governing the structure of a command or a programming language.

TEXT A collection of characters. Usually contrasted with graphics and images.

TOGGLE SWITCH

switch which has two states, turning on the first time it is used, and turning off the second time.

TRACK *See Sector.*

VIDEO Equipment or picture-producing elements that are used to display character or graphics on a cathode ray tube.

WARM-START To reinitialize a computer system without turning off the power (Thru pressing the Ctrl, Alt, and Del keys simultaneously). It is usually done after a programmer has lost control of a program or the operating system, it reloads the operating system.

WINDOW The segmented portion of a screen is called a window within which information is displayed. Some operating systems support several windows that can be viewed at the same time on a video screen.