

IBM Personal Computer Cluster Adapter Installation Instructions

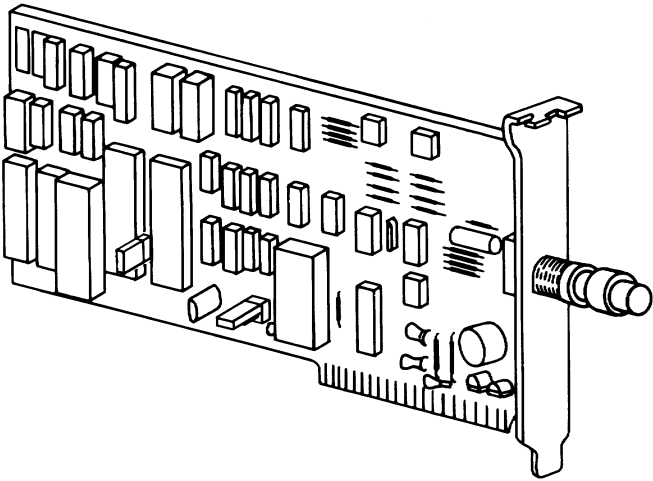

This option consists of the following:

- IBM Personal Computer Cluster Adapter
- Terminating plug (used with Problem Determination Procedures)
- Installation Instructions
- Problem Determination Procedures
- Diagnostics Diskette

If any items are missing or damaged, notify your place of purchase.

LIMITED WARRANTY

The International Business Machines Corporation warrants this IBM Personal Computer Product to be in good working order for a period of one year from the date of purchase from IBM or an Authorized IBM Personal Computer Dealer. Should this Product fail to be in good working order at any time during this one year warranty period, IBM will, at its option, repair or replace this Product at no additional charge except as set forth below. Repair parts and replacement Products will be furnished on an exchange basis and will be either reconditioned or new. All replaced parts and Products become the property of IBM. This limited warranty does not include service to repair damage to the Product resulting from accident, disaster, misuse, abuse, or non-IBM modification of the Product.

Limited Warranty service may be obtained by delivering the Product during the one year warranty period to an Authorized IBM Personal Computer Dealer, or any IBM Service Center and providing proof of purchase date. If this Product is delivered by mail, you agree to insure the Product or assume the risk of loss or damage in transit, to prepay shipping charges to the warranty service location and to use the original shipping container or equivalent. Contact an Authorized IBM Personal Computer Dealer or write to IBM Personal Computer, Sales and Service, P.O. Box 1328-W, Boca Raton, Florida 33432, for further information.

ALL EXPRESS AND IMPLIED WARRANTIES FOR THIS PRODUCT INCLUDING THE WARRANTIES OF MERCHANTABILITY AND FITNESS FOR A PARTICULAR PURPOSE, ARE LIMITED IN DURATION TO A PERIOD OF ONE YEAR FROM THE DATE OF PURCHASE, AND NO WARRANTIES, WHETHER EXPRESS OR IMPLIED, WILL APPLY AFTER THIS PERIOD. SOME STATES DO NOT ALLOW LIMITATIONS ON HOW LONG AN IMPLIED WARRANTY LASTS, SO THE ABOVE LIMITATIONS MAY NOT APPLY TO YOU.

IF THIS PRODUCT IS NOT IN GOOD WORKING ORDER AS WARRANTED ABOVE, YOUR SOLE REMEDY SHALL BE REPAIR OR REPLACEMENT AS PROVIDED ABOVE. IN NO EVENT WILL IBM BE LIABLE TO YOU FOR ANY DAMAGES, INCLUDING ANY LOST PROFITS, LOST SAVINGS OR OTHER INCIDENTAL OR CONSEQUENTIAL DAMAGES ARISING OUT OF THE USE OF OR INABILITY TO USE SUCH PRODUCT, EVEN IF IBM OR AN AUTHORIZED IBM PERSONAL COMPUTER DEALER HAS BEEN ADVISED OF THE POSSIBILITY OF SUCH DAMAGES, OR FOR ANY CLAIM BY ANY OTHER PARTY.

SOME STATES DO NOT ALLOW THE EXCLUSION OR LIMITATION OF INCIDENTAL OR CONSEQUENTIAL DAMAGES FOR CONSUMER PRODUCTS, SO THE ABOVE LIMITATIONS OR EXCLUSIONS MAY NOT APPLY TO YOU.

THIS WARRANTY GIVES YOU SPECIFIC LEGAL RIGHTS, AND YOU MAY ALSO HAVE OTHER RIGHTS WHICH MAY VARY FROM STATE TO STATE.

FEDERAL COMMUNICATIONS COMMISSION RADIO FREQUENCY INTERFERENCE STATEMENT

WARNING: This equipment has been certified to comply with the limits for a Class B computing device, pursuant to Subpart J of Part 15 of FCC rules. Only peripherals (computer input/output devices, terminals, printers, etc.) certified to comply with the Class B limits may be attached to this computer. Operation with non-certified peripherals is likely to result in interference to radio and TV reception.

INSTRUCTIONS TO USER

This equipment generates and uses radio frequency energy and if not installed and used properly, i.e., in strict accordance with the operating instructions, reference manuals, and the service manual, may cause interference to radio or television reception. It has been tested and found to comply with the limits for a Class B computing device pursuant to Subpart J of Part 15 of FCC Rules, which are designed to provide reasonable protection against such interference when operated in a residential installation.

If this equipment does cause interference to radio or television reception, which can be determined by turning the equipment off and on, the user is encouraged to try to correct the interference by one or more of the following measures:

- Reorient the receiving antenna.
- Relocate the equipment with respect to the receiver.
- Move the equipment away from the receiver.
- Plug the equipment into a different outlet so that equipment and receiver are on different branch circuits.
- Ensure that card mounting screws, attachment connector screws, and ground wires are tightly secured.
- Ensure that card slot covers are in place when no card is installed.
- If peripherals not offered by IBM are used with this equipment, it is suggested to use shielded, grounded cables, with in-line filters if necessary.

If necessary, consult your dealer service representative for additional suggestions.

The manufacturer is not responsible for any radio or TV interference caused by unauthorized modifications to this equipment. It is the responsibility of the user to correct such interference.

CAUTION: This product is equipped with a line cord and plug designed for the user's safety. It is to be used with a properly grounded power receptacle to avoid electrical shock.

Contents

Installation Requirements	3
Tools Required	5
Installation Instructions	7
Cluster Adapter Switch Settings	13
Setting Adapter Number	14
Setting Station Address	15
Connector Information	25
Cluster Information	27

Notes:

Installation Requirements

DANGER
TO HELP PROTECT FROM LIGHTNING
AND OTHER SOURCES OF ELECTRICAL
SHOCK, IBM REQUIRES THAT THE
COAXIAL CABLE SHIELDING BE
GROUNDED, AND NEITHER THE FRAME
NOR COVERS OF THE IBM PERSONAL
COMPUTER CAN BE USED AS THE
GROUNding POINT.

- To ensure proper operation of the Cluster, the shielding of the coaxial cable cannot be grounded at more than one point.
- If compliance to electrical codes require multiple ground points, then triaxial cable (double shielded) must be used. In using the triaxial cable, only the outer shielding can be grounded and under no circumstances should the outer shield be connected to the inner shield.
- This installation should be performed by a licensed electrician.

- The IBM Personal Computer Cluster Adapter is designed to interconnect up to 64 IBM Personal Computers using RG 59U coaxial cable.
- An Installation Manager is needed to plan, install, and maintain the Cluster (A Cluster is all of the Personal Computers, Cluster Adapters, and coaxial wiring). As the Cluster is being installed, it is necessary for the installation manager to develop a Cluster Map. The Cluster Map can be a diagram or listing of the Personal Computer location, the adapter number assigned, the station (a station is a Personal Computer on the Cluster) address, and the order in which the stations are connected.

Note: If you have an IBM Personal Computer XT or an IBM Personal Computer Expansion Unit omit the following information and continue with Tool Requirements.

- The Cluster Adapter requires your IBM Personal Computer System Unit to have a BIOS ROM module dated 10/27/82 or later. To determine the date of your ROM module, run the following BASIC program. Type the program exactly as shown.

```
10 DEF SEG=&HF000
20 FOR X=&HFFF5 TO &HFFFF
30 PRINT CHR$(PEEK(X));
40 NEXT
RUN
```

The date that is displayed is the date of your ROM module. Contact your authorized IBM Personal Computer dealer for a ROM module if it is needed.

Refer to the *IBM BASIC* manual for additional information on BASIC programs.

- The Cluster Adapter may be installed in either the system unit or the expansion unit.

Tool Requirements

- Medium-size, flat-blade screwdriver.

Optional:

- Medium screwstarter.
- 3/16-inch nutdriver.
- 1/4-inch nutdriver.

Notes:

Installation Instructions

- 1** Set the Power switch on the system unit (and expansion unit, if attached) to Off.
- 2** Set the Power switches on all external devices (printer, TV, etc.) to Off.
- 3** Unplug the system unit's (and expansion unit's) power cord from the wall outlet.
- 4** Disconnect all cables from the rear of the unit in which the option is to be installed.

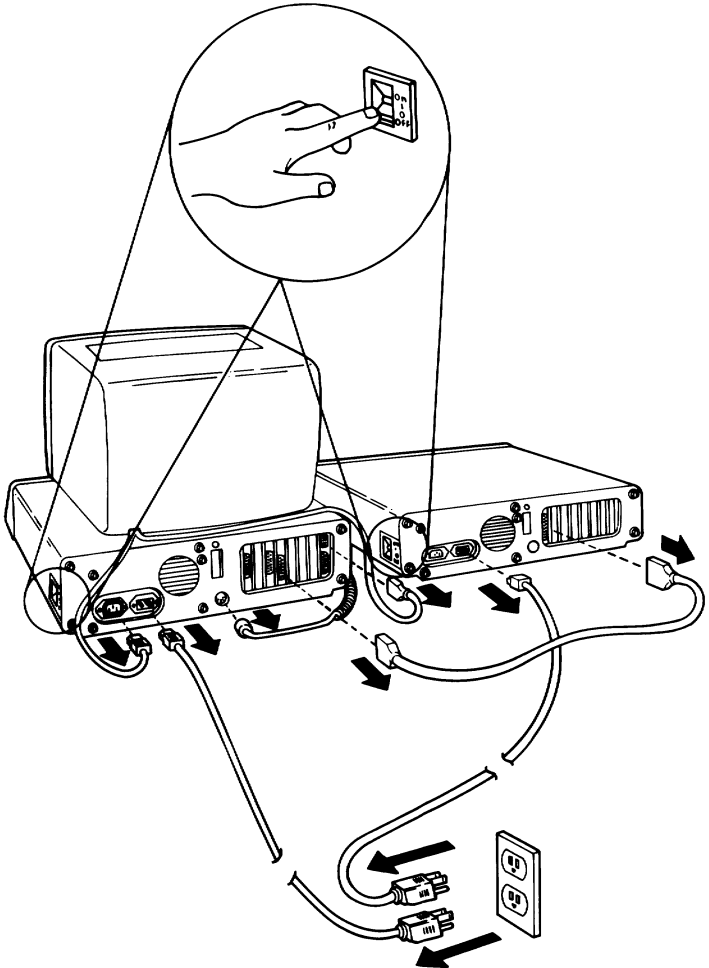

- 5** Move your keyboard and all disconnected devices away from the work area.
- 6** Move the unit in which you are installing the adapter (system unit or expansion unit) to allow access to the rear.
- 7** Use a flat-blade screwdriver or 1/4-inch nutdriver and remove the cover mounting screws by turning them counterclockwise as shown below. Save the screws for the reinstallation of the cover.

Cover Mounting Screws
(These screws may not be present on your unit)

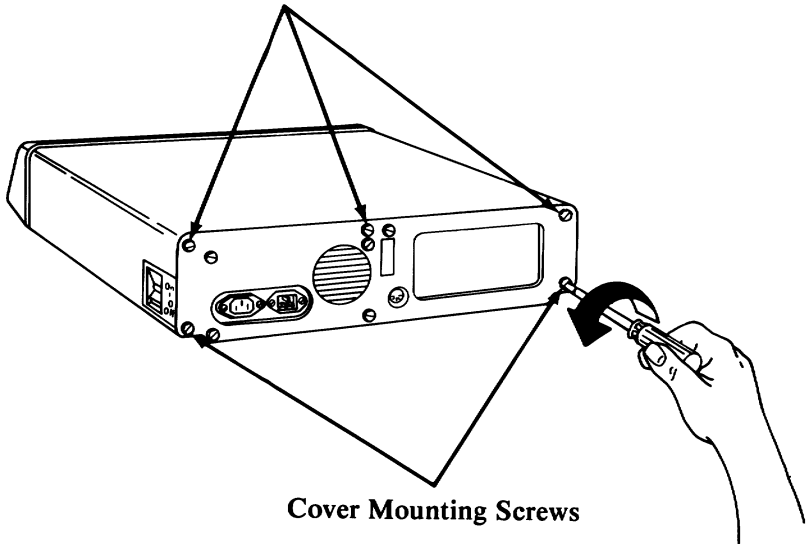

- 8** Carefully slide the unit's cover away from the rear and to the front, as shown in the figure below. When the cover will go no further, tilt it up, remove it from the base, and set it aside.

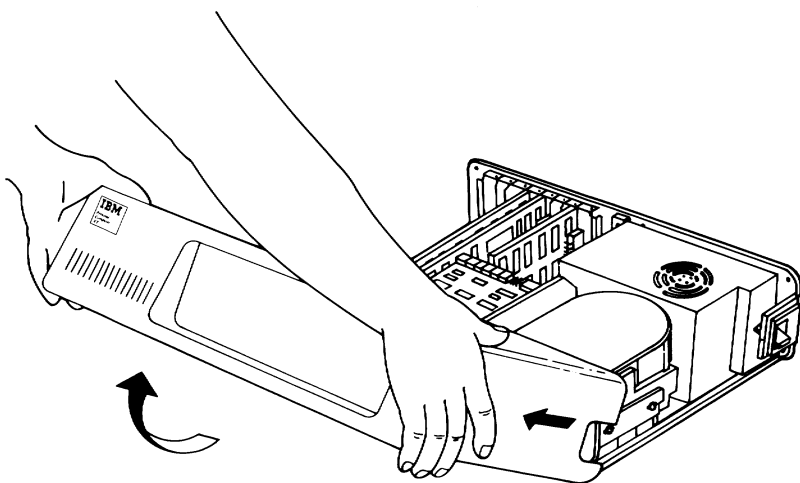
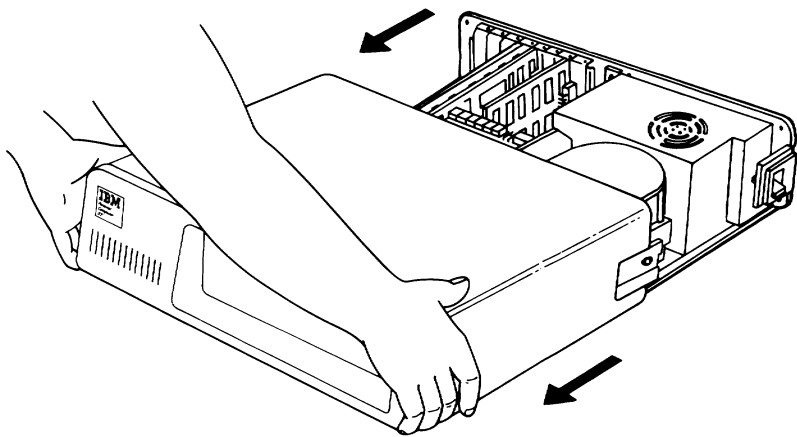

9

With the front of the unit toward you, look at the expansion slots inside the unit. The expansion slots are numbered from the left beginning with slot 1. If your unit has only 5 expansion slots, you can install the option in any unused slot. If your unit has 8 expansion slots, you can install the option in any unused slot from 1 through 6.

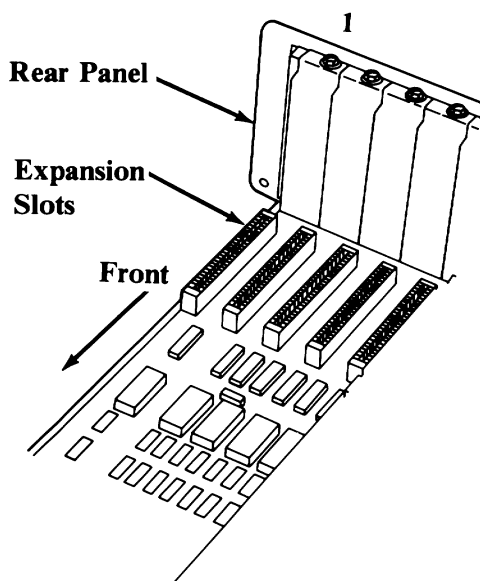

- 10** Use a flat-blade screwdriver or 3/16-inch nutdriver and remove the screw that holds the expansion-slot cover in place by turning the screw counterclockwise. Save the screw for installation of the option.

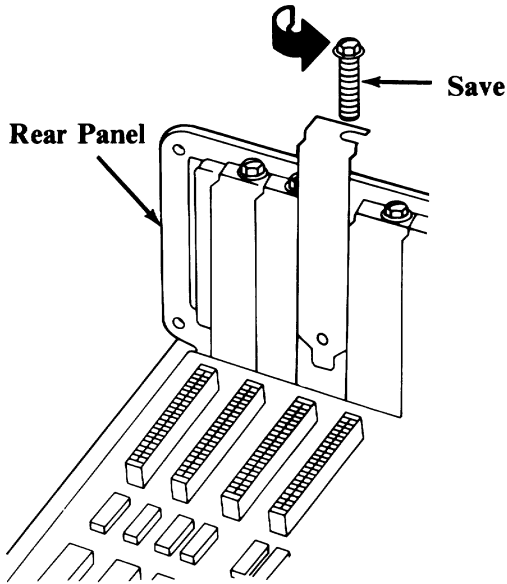

11 Look at the figure below and familiarize yourself with the Cluster Adapter, the location of the two switch blocks, and the location of the two jumpers.

The two switch blocks set the adapter number, the station address, and remote initial program load (IPL is a request for an operating program from another station on the Cluster). Special software is required for this function.

The two jumpers must be installed as shown.

Set the switches as described under "Cluster Adapter Switch Settings."

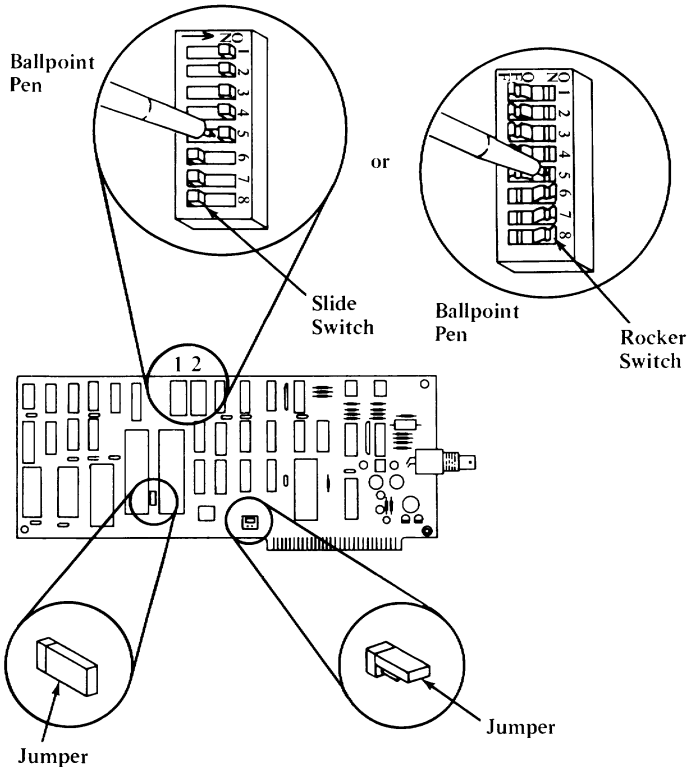

NOTE: Set a rocker switch by pressing the rocker down to the desired position.

Cluster Adapter Switch Settings

The two switch blocks on the Cluster Adapter are eight-position switches. The settings of the switch positions on the following pages determine the adapter number, the station address, and remote IPL (On/Off).

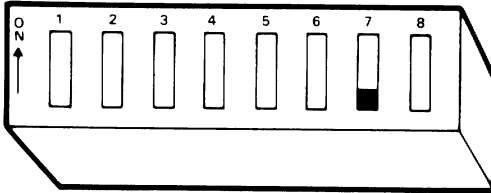

Switch Block 1

Switches	Function
1 - 6	Station address
7	Reserved (Always Off)
8	Remote IPL (On/Off)

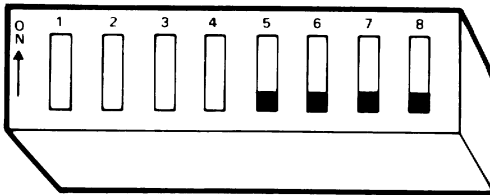

Switch Block 2

Switches	Function
1-2-3-4	Adapter number
5-6-7-8	Always Off

The following figure shows the settings for switches 1 through 4 of Switch Block 2 for Cluster adapter numbers 1 through 4.

Switches 5 through 8 of Switch Block 2 are always set to Off.

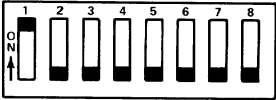
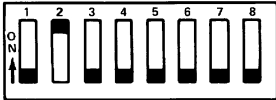
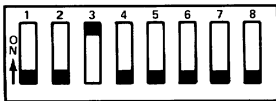
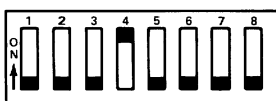
<p>Select Adapter 1: Switch Block 2, Switch 1</p>	 <p>The diagram shows a row of eight switches labeled 1 through 8. Switch 1 is in the 'ON' position, indicated by a black bar at the bottom and an upward-pointing arrow. Switches 2 through 8 are in the 'OFF' position, indicated by a white bar at the bottom.</p>
<p>Select Adapter 2: Switch Block 2, Switch 2</p>	 <p>The diagram shows a row of eight switches labeled 1 through 8. Switch 2 is in the 'ON' position, indicated by a black bar at the bottom and an upward-pointing arrow. Switches 1, 3, 4, 5, 6, 7, and 8 are in the 'OFF' position, indicated by a white bar at the bottom.</p>
<p>Select Adapter 3: Switch Block 2, Switch 3</p>	 <p>The diagram shows a row of eight switches labeled 1 through 8. Switch 3 is in the 'ON' position, indicated by a black bar at the bottom and an upward-pointing arrow. Switches 1, 2, 4, 5, 6, 7, and 8 are in the 'OFF' position, indicated by a white bar at the bottom.</p>
<p>Select Adapter 4: Switch Block 2, Switch 4</p>	 <p>The diagram shows a row of eight switches labeled 1 through 8. Switch 4 is in the 'ON' position, indicated by a black bar at the bottom and an upward-pointing arrow. Switches 1, 2, 3, 5, 6, 7, and 8 are in the 'OFF' position, indicated by a white bar at the bottom.</p>

Note: If one Cluster Adapter is installed in an IBM Personal Computer, it must be set to adapter number 1. Each additional adapter must have a different Cluster adapter number.













The following figure shows the settings for switches 1 through 6 of Switch Block 1 for station addresses 0 to 21.

Switch 7 of Switch Block 1 is always set to Off.

Station Address	Switch Block 1	Station Address	Switch Block 1
0		11	
1		12	
2		13	
3		14	
4		15	
5		16	
6		17	
7		18	
8		19	
9		20	
10		21	

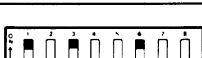
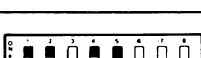

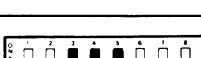
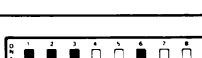
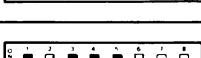
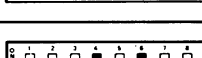
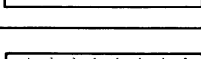
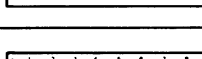
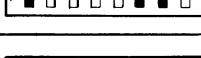
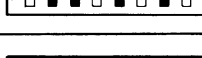
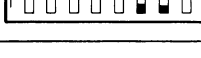







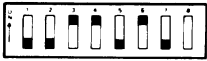

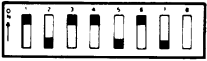

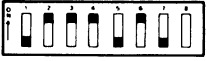

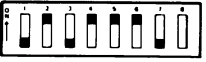

The following figure shows the settings for switches 1 through 6 of Switch Block 1 for station addresses 22 to 43.

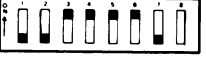
Switch 7 of Switch Block 1 is always set to Off.

Station Address	Switch Block 1	Station Address	Switch Block 1
22		33	
23		34	
24		35	
25		36	
26		37	
27		38	
28		39	
29		40	
30		41	
31		42	
32		43	

The following figure shows the settings for switches 1 through 6 of Switch Block 1 for station addresses 44 to 63.

Switch 7 of Switch Block 1 is always set to Off.

Station Address	Switch Block 1	Station Address	Switch Block 1
44		55	
45		56	
46		57	
47		58	
48		59	
49		60	
50		61	
51		62	
52		63	
53			
54			

The following figure shows the setting for switch 8 of Switch Block 1.

With switch 8 of Switch Block 1 set to On, the Personal Computer will request an IPL from another station on the Cluster. This request delays POST completion by 30 seconds.

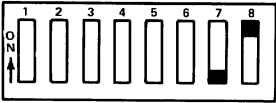
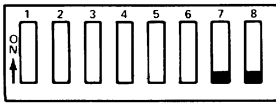
<p>Remote IPL ON: Switch Block 1, Switch 8</p>	 <p>The diagram shows a row of eight vertical switches labeled 1 through 8. To the left of the switches is a vertical label 'ON' with an upward-pointing arrow. Switch 8 is the only one with a black bar at the bottom, indicating it is turned on.</p>
<p>Remote IPL OFF: Switch Block 1, Switch 8</p>	 <p>The diagram shows a row of eight vertical switches labeled 1 through 8. To the left of the switches is a vertical label 'OFF' with an upward-pointing arrow. Switch 8 is the only one with a black bar at the bottom, indicating it is turned off.</p>

Fill in the necessary information for the adapter number, station address, and remote IPL in step 4 of the "Test 2200" section.

- 12** Hold the option by the top and firmly press it into the expansion slot, as shown below.

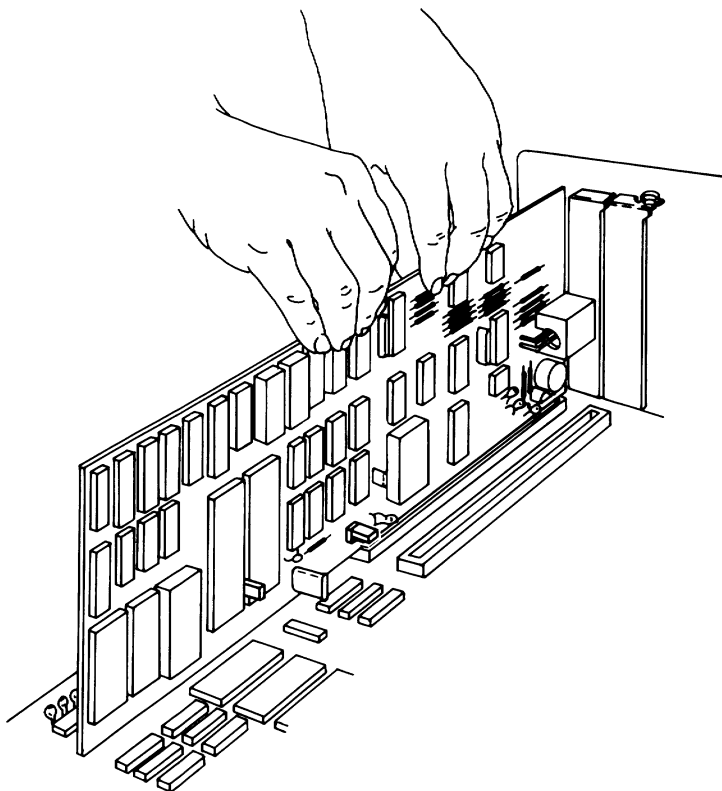

- 13** Align the slot in the option retaining bracket with the hole in the rear panel of the system unit (or expansion unit). Start the screw clockwise, then tighten with a flat-blade screwdriver or a 3/16-inch nutdriver.

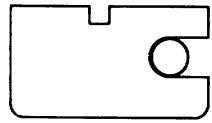
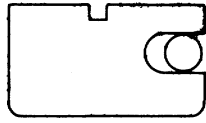
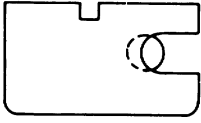

**Not
Aligned**

**Properly
Aligned**

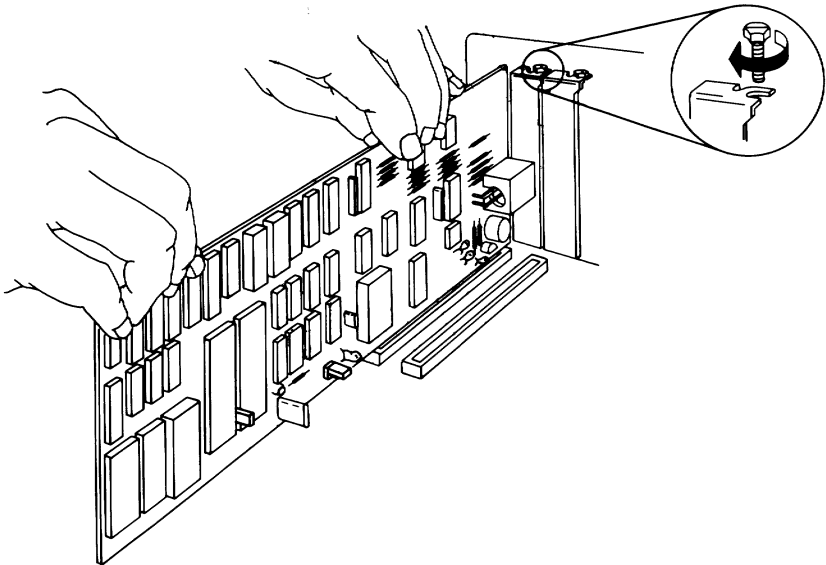

- 14** If you have any other options to install, do so now before putting the unit's cover back on.

Put the unit's cover on by placing it as shown and carefully sliding it toward the rear of the unit.

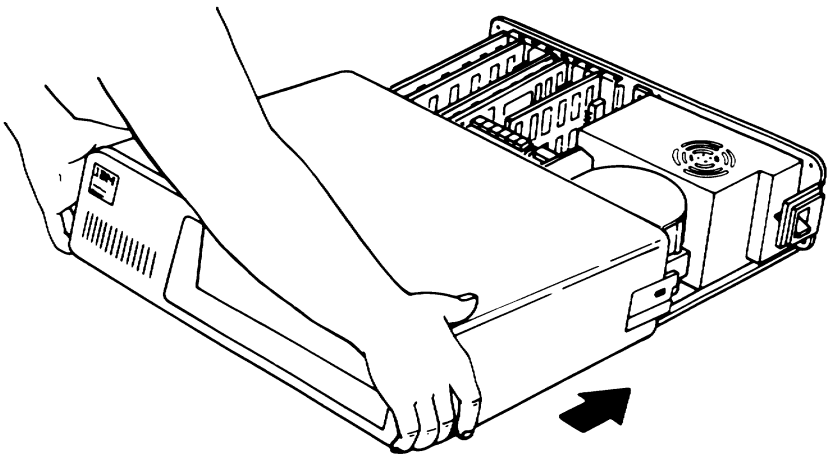
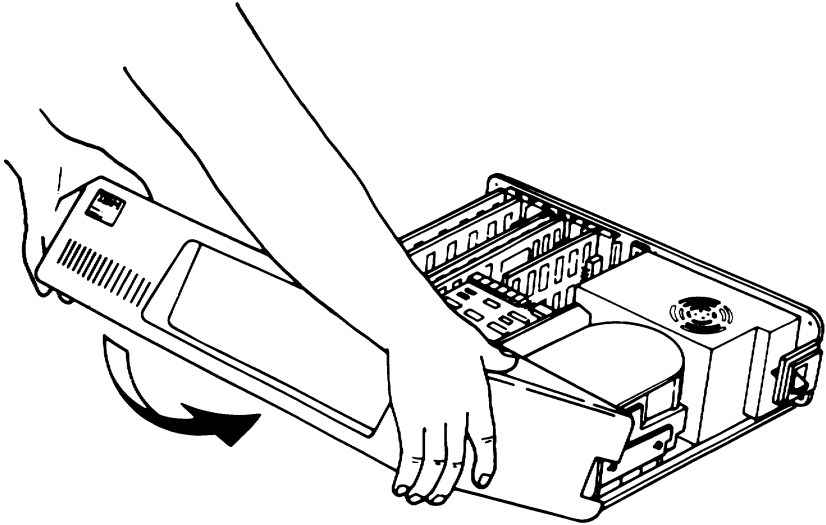

- 15** When the cover is all the way to the rear, align the screws with the threaded tabs and tighten. Use a flat-blade screwdriver or 1/4-inch nutdriver and turn clockwise.

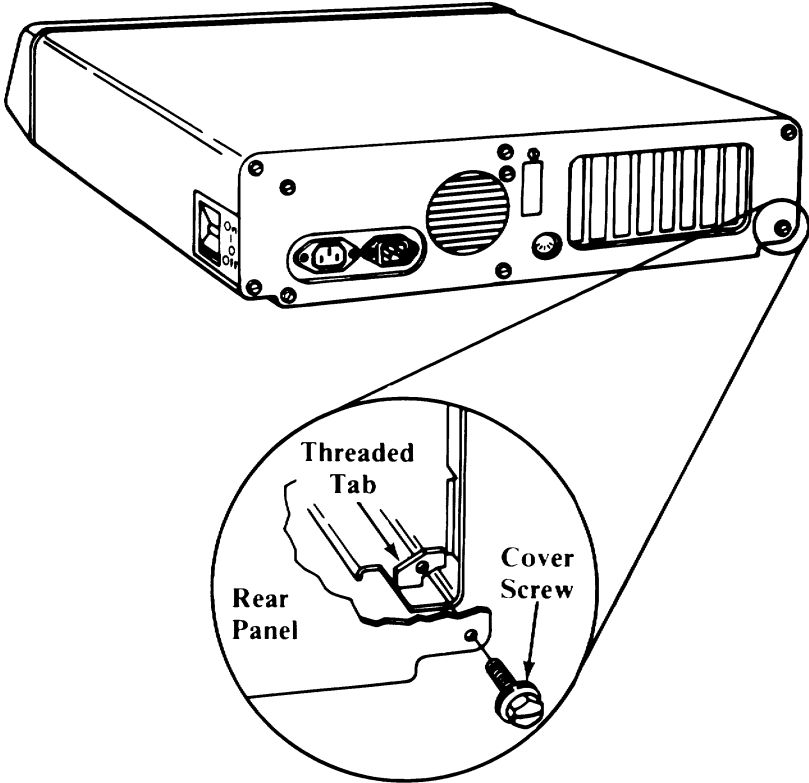

- 16** When you have completed installation of the Cluster Adapter, contact your Installation Manager for installation of the coaxial cable.
- 17** Your system unit (and expansion unit, if attached) are now ready to be recabled. Refer to the section titled "Setup" or "Introduction/Installation" in your *Guide to Operations* manual.
- 18** If you have any problem after installation, one of the following is the most likely cause:
- Switches set incorrectly
 - A missing jumper on the adapter
 - Cabling is incorrect
 - Other options may have loosened
 - Cluster Adapter is defective

Notes:

(

(

(

Connector Information

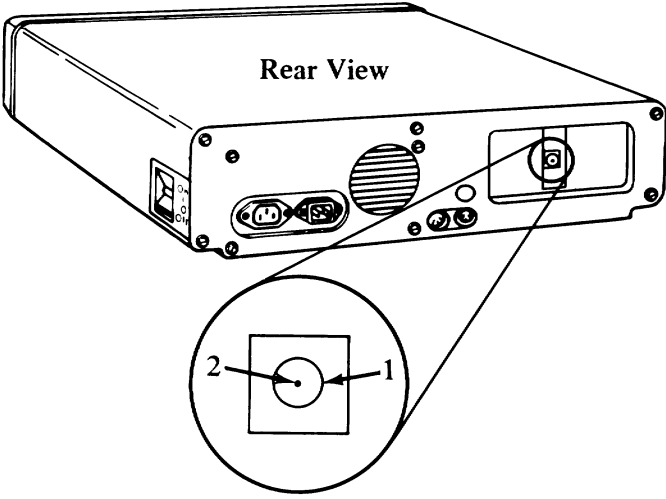

Coaxial Connector

Signal Name - Description	
Outer Conductor	1
Inner Conductor	2
Cluster Adapter	Cluster Adapter

Cluster Information

The following is a sample Cluster and the parts required to install the Cluster cable. All parts shown are available in the IBM Personal Computer Cluster Cable Kit (IBM Option 1501207).

One terminating plug (IBM part number 6320352) must be installed at each end of the main coaxial bus and only two terminating plugs can be on the coaxial cable.

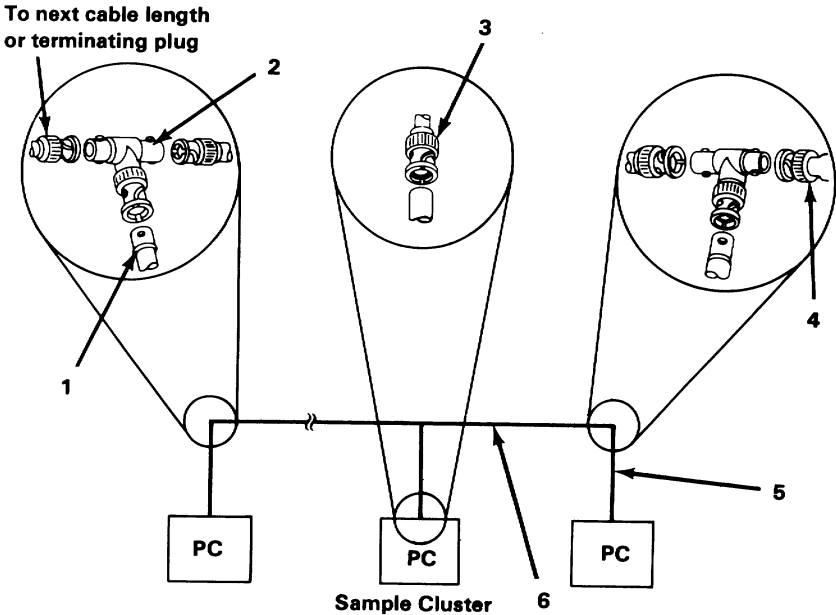

Figure Reference	Part Number	Description
1	6320352	BNC Jack (20 AWG*)
2		BNC "T" Connector (20 AWG*)
3		BNC Plug (20 AWG*)
4		Terminating Plug
5		Cluster Drop (RG59U) Maximum Length - 5 Meters Minimum Length - 1 Meter
6		Cluster Bus (RG59U) Maximum Length - 1000 Meters

*AWG - American Wire Gauge

Notes: