

IBM

*Personal Computer PCjr
Hardware Reference
Library*

Guide to Operations

6322959

LIMITED WARRANTY

The International Business Machines Corporation warrants this IBM Personal Computer Product to be in good working order for a period of one year from the date of purchase from IBM or an Authorized IBM Personal Computer Dealer. Should this Product fail to be in good working order at any time during this one year warranty period, IBM will, at its option, repair or replace this Product at no additional charge except as set forth below. Repair parts and replacement Products will be furnished on an exchange basis and will be either reconditioned or new. All replaced parts and Products become the property of IBM. This limited warranty does not include service to repair damage to the Product resulting from accident, disaster, misuse, abuse, or non-IBM modification of the Product.

Limited Warranty service may be obtained by delivering the Product during the one year warranty period to an Authorized IBM Personal Computer Dealer, or any IBM Service/Exchange Center and providing proof of purchase date. If this Product is delivered by mail, you agree to insure the Product or assume the risk of loss or damage in transit, to prepay shipping charges to the warranty service location and to use the original shipping container or equivalent. Contact an Authorized IBM Personal Computer Dealer or write to IBM Personal Computer, Sales and Service, P.O. Box 1328-W, Boca Raton, Florida 33432, for further information.

ALL EXPRESS AND IMPLIED WARRANTIES FOR THIS PRODUCT INCLUDING THE WARRANTIES OF MERCHANTABILITY AND FITNESS FOR A PARTICULAR PURPOSE, ARE LIMITED IN DURATION TO A PERIOD OF ONE YEAR FROM THE DATE OF PURCHASE, AND NO WARRANTIES, WHETHER EXPRESS OR IMPLIED, WILL APPLY AFTER THIS PERIOD. SOME STATES DO NOT ALLOW LIMITATIONS ON HOW LONG AN IMPLIED WARRANTY LASTS, SO THE ABOVE LIMITATIONS MAY NOT APPLY TO YOU.

IF THIS PRODUCT IS NOT IN GOOD WORKING ORDER AS WARRANTED ABOVE, YOUR SOLE REMEDY SHALL BE REPAIR OR REPLACEMENT AS PROVIDED ABOVE. IN NO EVENT WILL IBM BE LIABLE TO YOU FOR ANY DAMAGES, INCLUDING ANY LOST PROFITS, LOST SAVINGS OR OTHER INCIDENTAL OR CONSEQUENTIAL DAMAGES ARISING OUT OF THE USE OF OR INABILITY TO USE SUCH PRODUCT, EVEN IF IBM OR AN AUTHORIZED IBM PERSONAL COMPUTER DEALER HAS BEEN ADVISED OF THE POSSIBILITY OF SUCH DAMAGES, OR FOR ANY CLAIM BY ANY OTHER PARTY.

SOME STATES DO NOT ALLOW THE EXCLUSION OR LIMITATION OF INCIDENTAL OR CONSEQUENTIAL DAMAGES FOR CONSUMER PRODUCTS, SO THE ABOVE LIMITATIONS OR EXCLUSIONS MAY NOT APPLY TO YOU.

THIS WARRANTY GIVES YOU SPECIFIC LEGAL RIGHTS, AND YOU MAY ALSO HAVE OTHER RIGHTS WHICH MAY VARY FROM STATE TO STATE.

FOR WARRANTY SERVICE OR ASSISTANCE IT IS RECOMMENDED THAT THIS PRODUCT BE RETURNED TO THE AUTHORIZED IBM PERSONAL COMPUTER DEALER FROM WHOM IT WAS PURCHASED OR TO ANY IBM SERVICE/EXCHANGE CENTER.



*Personal Computer PCjr
Hardware Reference
Library*

Guide to Operations

First Edition Revised (November 1983)

Changes are periodically made to the information herein; these changes will be incorporated in new editions of this publication.

Products are not stocked at the address below. Requests for copies of this product and for technical information about the system should be made to your authorized IBM Personal Computer dealer.

A Reader's Comment Form is provided at the back of this publication. If this form has been removed, address comments to IBM Corporation, Personal Computer, P.O. Box 1328-C, Boca Raton, Florida 33432. IBM may use or distribute any of the information you supply in any way it believes appropriate without incurring any obligations whatever.

FEDERAL COMMUNICATIONS COMMISSION RADIO FREQUENCY INTERFERENCE STATEMENT

Warning: This equipment has been certified to comply with the limits for a Class B computing device, pursuant to Subpart J of Part 15 of FCC rules. Only peripherals (computer input/output devices, terminals, printers, etc.) certified to comply with the Class B limits may be attached to this computer. Operation with non-certified peripherals is likely to result in interference to radio and TV reception.

INSTRUCTIONS TO USER

This equipment generates and uses radio frequency energy and if not installed and used properly, i.e., in strict accordance with the operating instructions, reference manuals, and the service manual, may cause interference to radio or television reception. It has been tested and found to comply with the limits for a Class B computing device pursuant to Subpart J of Part 15 of FCC Rules, which are designed to provide reasonable protection against such interference when operated in a residential installation.

If this equipment does cause interference to radio or television reception, which can be determined by turning the equipment off and on, the user is encouraged to try to correct the interference by one or more of the following measures:

- Reorient the receiving antenna.
- Relocate the equipment with respect to the receiver.
- Move the equipment away from the receiver.
- Plug the equipment into a different outlet so that equipment and receiver are on different branch circuits.
- Ensure that side option mounting screws, attachment connector screws, and ground wires are tightly secured.
- If peripherals not offered by IBM are used with this equipment, it is suggested that you use shielded, grounded cables with in-line filters, if necessary.

If necessary, consult your dealer service representative for additional suggestions.

The manufacturer is not responsible for any radio or TV interference caused by unauthorized modifications to this equipment. It is the responsibility of the user to correct such interference.

CAUTION

This product is equipped with a UL listed and CSA-certified plug for the user's safety. It is to be used in conjunction with a properly grounded 115 Vac receptacle to avoid electrical shock.

Preface



Color tabs are on the first page of each section. The color tabs are labeled to help you quickly find the information you need.

The seven sections in this book are:

Section 1, "Setting Up Your IBM PCjr," explains how to cable your IBM PCjr.

Section 2, "Getting Started," shows you how to run the "Keyboard Adventure" stored in your IBM PCjr.

Section 3, "The Keyboard," explains how to use your keyboard.

Setup

Starting

Keyboard

Keys

Options

Testing

Cartridges

Index

Section 4, "Choosing Keys," shows you how to use your IBM PCjr keyboard with books written for the IBM Personal Computer keyboard.

Section 5, "The IBM PCjr Options," is a Section in which you can keep any information you receive when you buy an option for your IBM PCjr.

Section 6, "Testing Your IBM PCjr," contains a set of instructions that help you determine if your IBM PCjr is operating properly.

Section 7, "Cartridges," explains how to take care of cartridges and how to use them with your IBM PCjr.

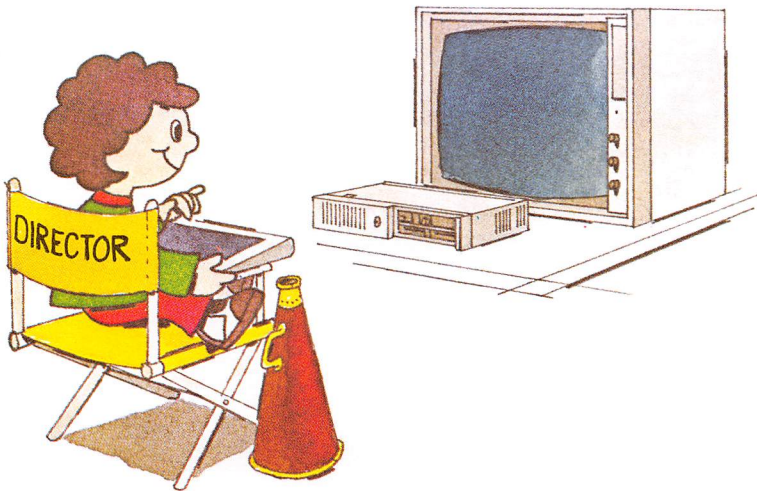

Contents

SECTION 1. SETTING UP YOUR IBM PCjr . . .	1-1
Installation	1-5
SECTION 2. GETTING STARTED	2-1
What to Expect When You Turn Your IBM PCjr Power on.	2-3
Running the Keyboard Adventure	2-6
SECTION 3. THE KEYBOARD	3-1
Introduction	3-3
Using the Keyboard	3-4
Centering the Information on the Screen	3-9
Keyboard Modes	3-13
System Reset	3-25
Additional Keyboard Features	3-26
SECTION 4. CHOOSING KEYS	4-1
Introduction	4-3
When to Use the Keyboard Differences Chart	4-5
Using the Keyboard Difference Chart	4-6
Keyboard Difference Chart	4-9
SECTION 5. THE IBM PCjr OPTIONS	5-1
Instructions	5-3
SECTION 6. TESTING YOUR IBM PCjr	6-1
Introduction	6-3
First Things First	6-5
Error Message Table	6-17
Running the IBM PCjr Tests	6-21
Service Information	6-37
Test Tag 1 - Diskette Drive Test	6-39

Test Tag 4 - Television and 40-Column Display Test	6-45
Test Tag 8 - 80 Column Display Test	6-55
IBM Color Display Check Out Procedure..	6-69
Test Tag 5 - Light Pen Test	6-83
Test Tag 6 - IBM PCjr Attachable Joystick Test	6-87
Test Tag 9 - Sound Test	6-93
Test Tag J - IBM PCjr Keyboard Test ..	6-103
Test Tag G - IBM PCjr Internal Modem Test	6-111
Test Tag A - IBM Personal Computer Graphics Printer Test	6-115
IBM Graphics Printer Check Out Procedure	6-119

SECTION 7. CARTRIDGES	7-1
Introduction	7-3
How to Handle Cartridges	7-5
How to Insert and Remove Cartridges .	7-6
Index	I-1

SECTION 1. SETTING UP YOUR IBM PCjr

Contents

Installation	1-5
--------------------	-----

Notes:

Replace this page with the setup pages from your IBM PCjr carton.

Notes:



Installation

Install your display or television now, using the instructions that come with your IBM Color Display or IBM Connector for Television. Then return here.

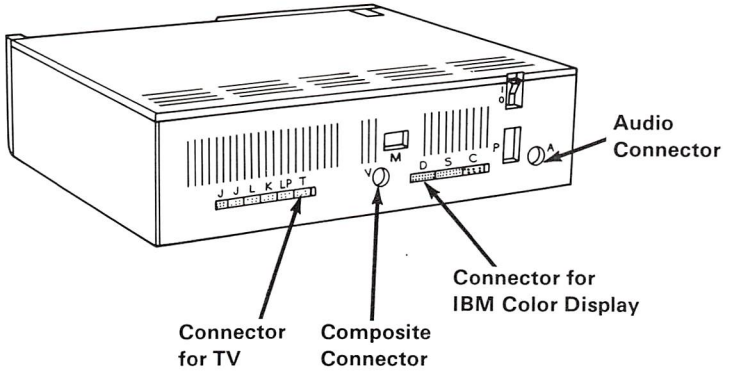

When your display or television is installed, continue with Section 2, "Getting Started."

Note: Diskette errors may be caused if your display is within 15 centimeters (6 inches) of your IBM PCjr. This problem is easily cured by moving your display away from the IBM PCjr.

Notes:

SECTION 2. GETTING STARTED

Contents

What to Expect When You Turn Your IBM PCjr Power On.	2-3
Running the Keyboard Adventure	2-6

It's Easy!
We'll Take You Step By Step...

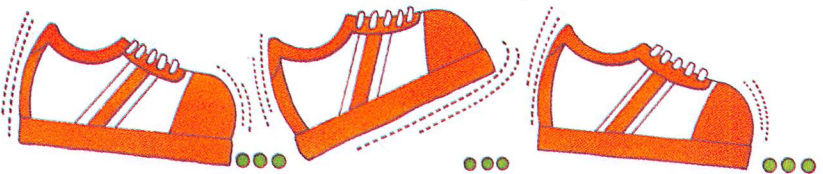

Notes:



What to Expect When You Turn Your IBM PCjr Power On.

Important

Whenever your IBM PCjr does not respond as described in this book, go to Section 6, "Testing your IBM PCjr."

Some of the colors shown in this book may be different than the colors on the screen. This happens because all televisions and displays do not produce the same colors. If you are asked if your screen looks like an example in this book, the question really refers to the shapes of the color blocks and figures.

To operate properly, your IBM PCjr keyboard must be in front of your IBM PCjr and no more than 6.1 meters (20 feet) away. Your IBM PCjr and the keyboard are connected by an invisible beam, so don't place anything between them that will block that beam.

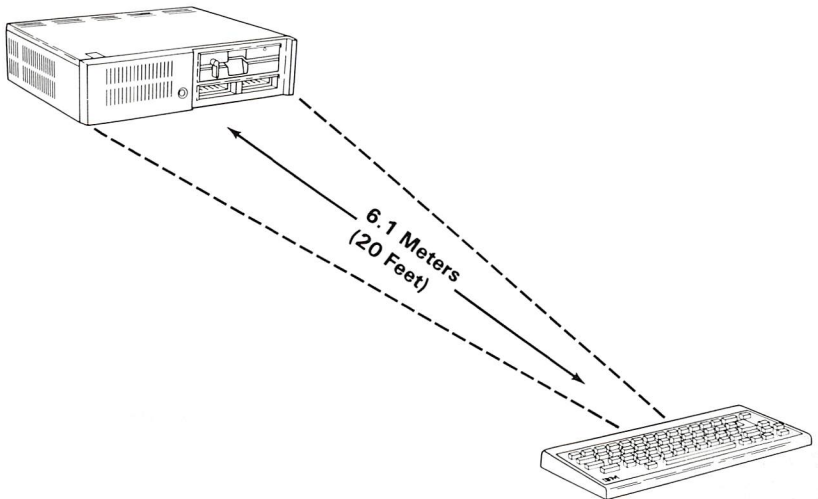

Do not turn your IBM PCjr power on yet. Let's take a minute to review what should happen when you do.

It takes a few seconds for something to appear on the screen. When it does, it looks like this:

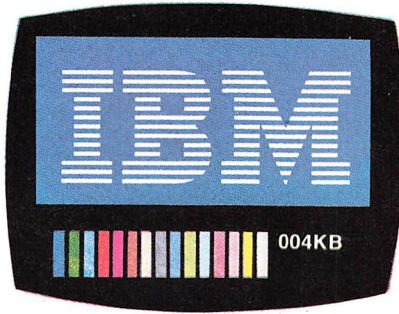

This screen is called the IBM Color Bar screen and it appears for a few seconds. While it does, your IBM PCjr is checking itself to be sure it is ready to go to work. After your IBM PCjr has checked itself and finds that everything is working correctly, you hear one short beep and the screen changes.



Turn your display or television power on.

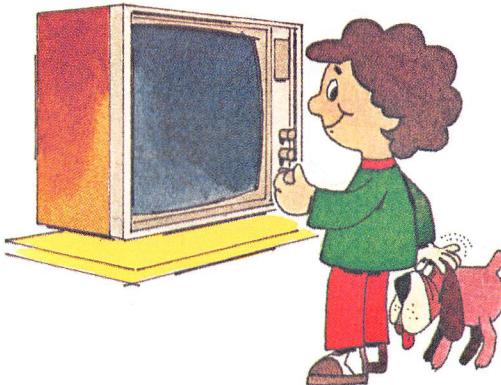



Turn your IBM PCjr power on.

- | This is the international symbol for On.
- This is the international symbol for Off.

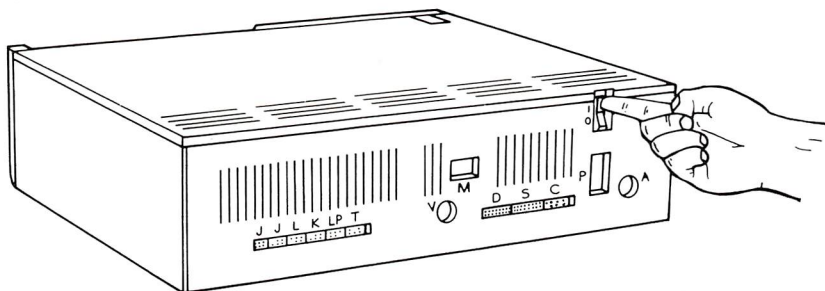

Following the IBM Color Bar screen, the IBM Personal Computer BASIC Message Screen appears.



Adjust the contrast, brightness and fine tuning on your display or television so it is comfortable for you.

```
The IBM Personal Computer Basic
Version C1.20 Copyright IBM Corp.1981
XXXXX Bytes free
OK
—
```

```
1 [LIST] 2 [RUN] 3 [LOAD] 4 [SAVE] 5 [CONT]
```

Running the Keyboard Adventure



Press the Esc key. This key is in the upper left corner of your keyboard.

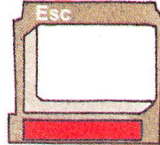

If you make a mistake and press any other key before you press Esc, you will not be able to run the "Keyboard Adventure." If the screen did not change when you pressed the Esc key, turn your IBM PCjr power off, wait about five seconds, turn it on again, and press the Esc key.

Your screen should now look like this:

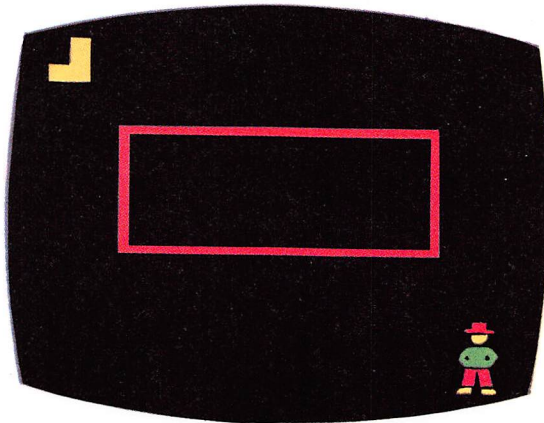

You are now ready to start the "Keyboard Adventure".

If your IBM PCjr did not respond correctly, go to Section 6, "Testing your IBM PCjr."

You will not hear the sounds this book describes if you are using a display that does not have a speaker and amplifier attached to it.

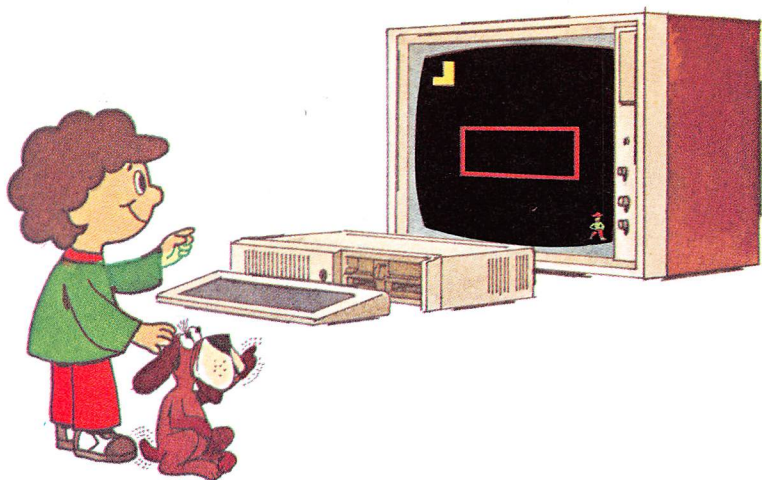

We would like you to meet P.C., who will be your guide through this "Keyboard Adventure."



If you are ready to join P.C., let's begin.

On the right side of your keyboard are four keys grouped together. Each of these keys has an arrow next to it and a green stripe under it.

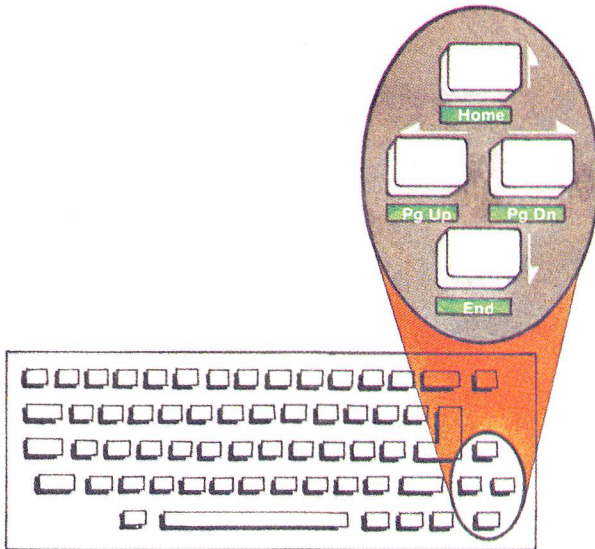

These keys are called cursor control keys. In computer talk, a cursor is a character (sometimes a blinking line or block) that shows you where you are on the screen. You can move a cursor up, down, right, or left with the cursor control keys.

In this part of your "Keyboard Adventure," P.C. will pretend to be a cursor to show you how to move around the screen. Each of the cursor control keys moves P.C. in the direction of the arrow. If a cursor control key is pressed and released, P.C. will move one position and stop. If the key is held down P.C. will continue to move.

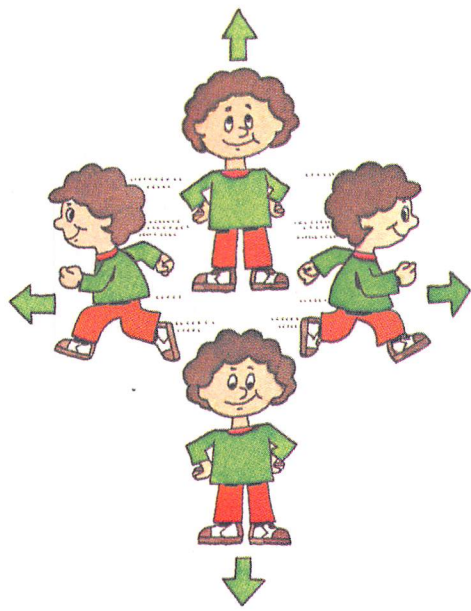



Move P.C. to the top of the screen by holding down the Cursor Up key. (This key has the word "Home" under it.)

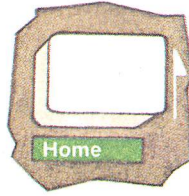

Did you hear a beep when P.C. reached the very top? A beep sounds whenever P.C. goes as far as he can go in one direction on this screen.

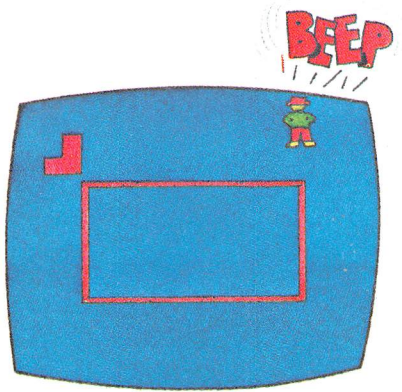

Now, let's find out what that strange object is on the left side of the screen.

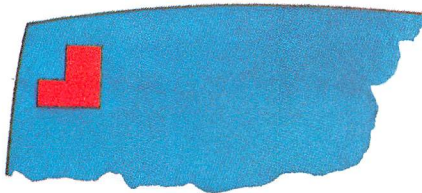

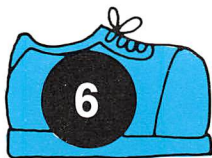

Using the cursor control keys, move P.C. through the object on the left side of your screen. (Make sure the object disappears from the screen.)

HINT: If this doesn't work the first time you try it, just continue to move P.C. around the object until it vanishes from the screen.

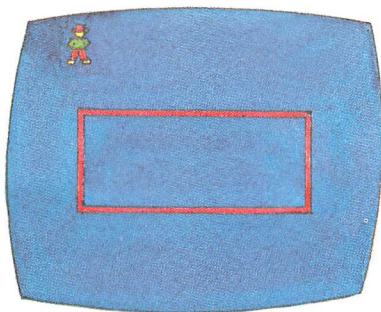

What's happened to the box? Is that a secret door that just opened? Do you suppose there's any connection between the object and the unlocking of the door? Let's see if we can solve this mystery. Perhaps P.C. can help us!



Using the cursor control keys, move P.C. to the opening of the box.

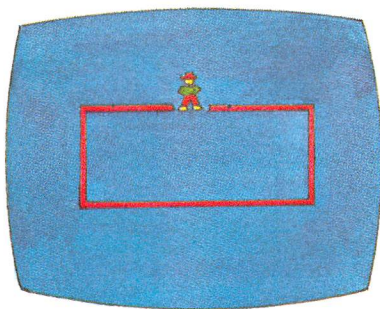

Now, if you were P.C., wouldn't you be curious enough to peek inside the box?

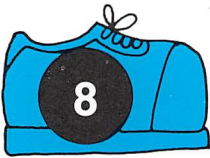
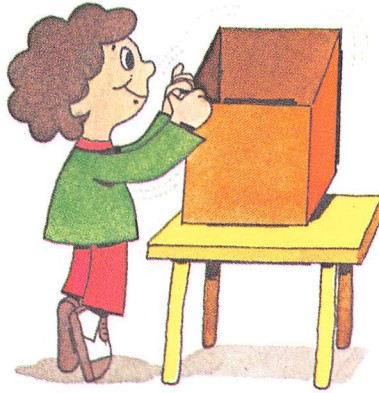

Move P.C. as far down into the box as possible.

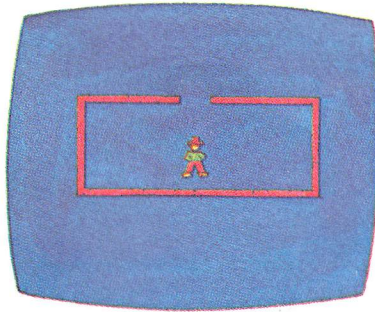

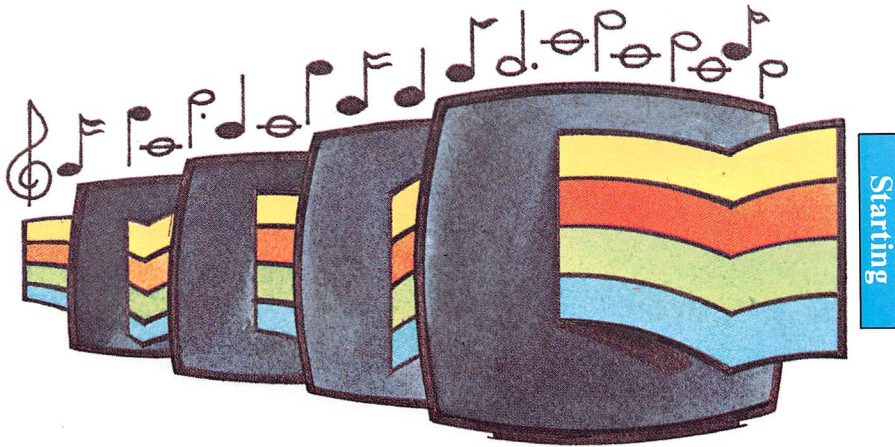

What happened???

As you can see, there's no need to worry. P.C. is back.

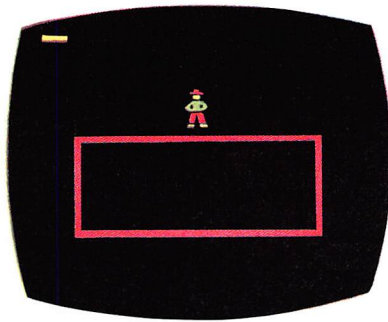

In fact, P.C. is ready to guide you through another adventure.



Let's find out what P.C. wants you to do. Perhaps if you press the cursor control keys again...

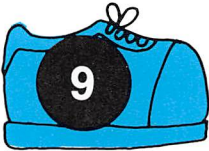

Press each cursor control key once.

Do you have any idea what P.C. is doing?

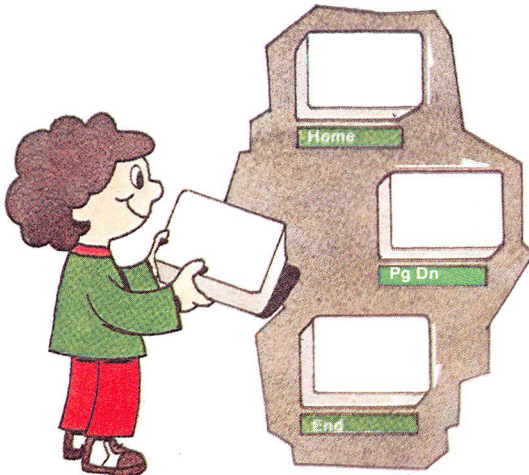

It looks as if a keyboard is being built. See how closely those four blocks resemble the four cursor control keys you just pressed? Notice the pattern they make on the screen.

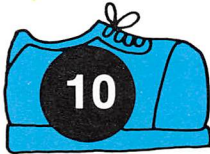

Press the Cursor Right key again - three or four times - and watch the screen closely.

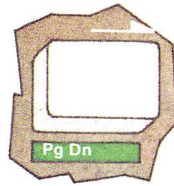

Look at the small line moving across the top of your screen as you press the Cursor Right key.



Press the Cursor Left key several times.

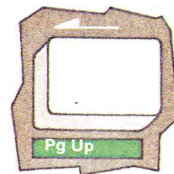

Remember when we told you about the cursor? Well, this is a cursor. Cursors come in different styles. Some, like this one, are little lines. Some are blocks. Some are bright, and some will even blink at you to catch your eye. But they all do the same thing - they let you know where you can place something on the screen.

As you can see, you are in control of the cursor now and can move it to the left or right.

Let's make this cursor work for you.

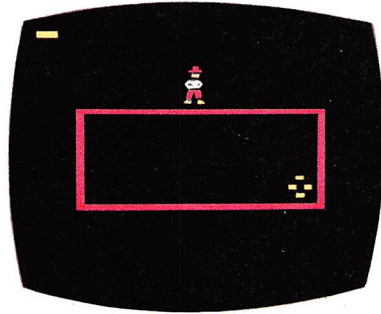

Type your first name in lowercase letters.

If you make a mistake, press the Cursor Left key until the cursor is under the letter you want to change. Then type the correct letter over the incorrect one. (Afterwards, make sure you move the cursor to the right of the last letter you typed and then continue typing.)

Is your first name on the screen? How does it feel to see your name in lights? (For now, we are pretending that your name is Tommy.)

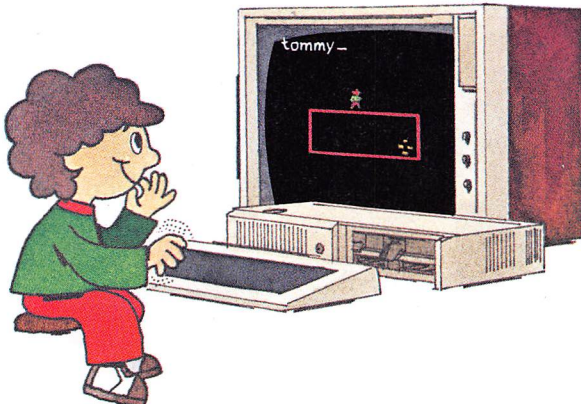

Now let's begin your name with a capital letter:



Press the Cursor Left key until the cursor is under the first letter of your name.

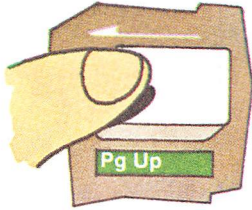

Locate one of the keys marked "Shift".

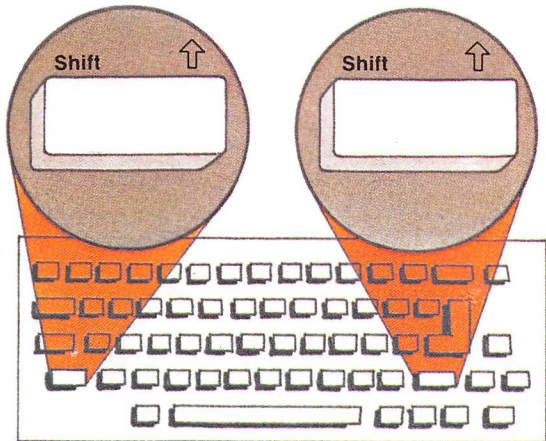

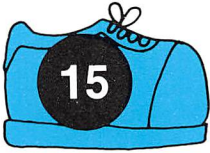

Hold down a Shift key, and, at the same time, retype the first letter of your name.

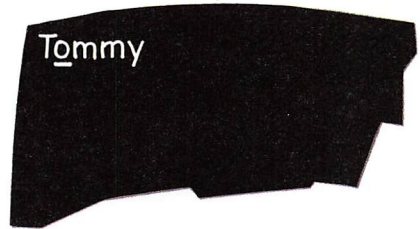
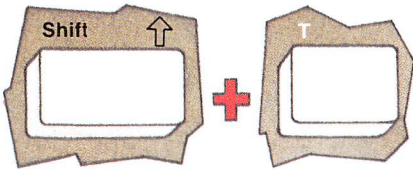

Suppose you wanted to type something in uppercase letters. There are two ways you could do this. The first way would be to hold down a Shift key and, at the same time, type the letters. But, an easier way is to use the CapsLock key.

Just for fun, use the CapsLock key to type your first name in uppercase letters. To do that:



Press the CapsLock key and release it.

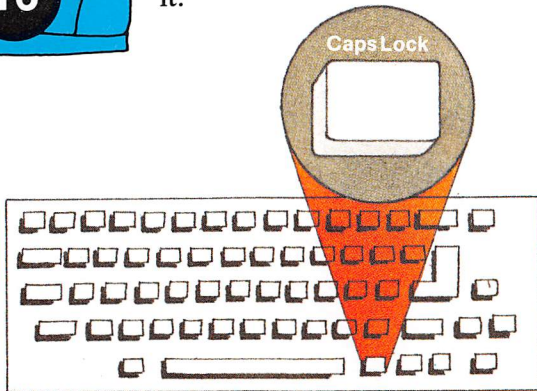

If you look at your screen, you will see that the cursor is already under the second letter of your name. So...



Type the rest of your first name again.

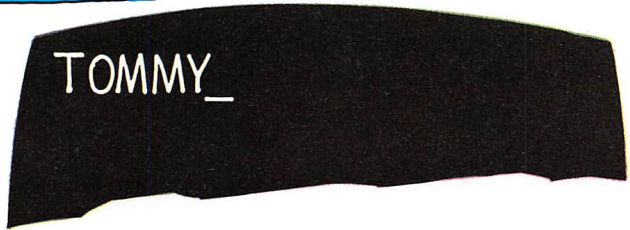

Did your name appear in uppercase letters on the screen? If so:



Press the CapsLock key again to turn off uppercase.



By the way, this is a key that you have to press twice - the first time to lock the keyboard in uppercase and a second time to unlock it.

REMEMBER:

- Press CapsLock once to get uppercase.
- Press CapsLock again to return to lowercase.

You have just seen how using the cursor control keys moves the cursor to letters you want to change. The process of changing what you type is called editing.

You have also seen that you can use a Shift key to make uppercase letters and the CapsLock key to lock your keyboard in uppercase.

A few words now about the most important key on the keyboard - the Enter key. This key is on the right side of your keyboard just above the right Shift key.

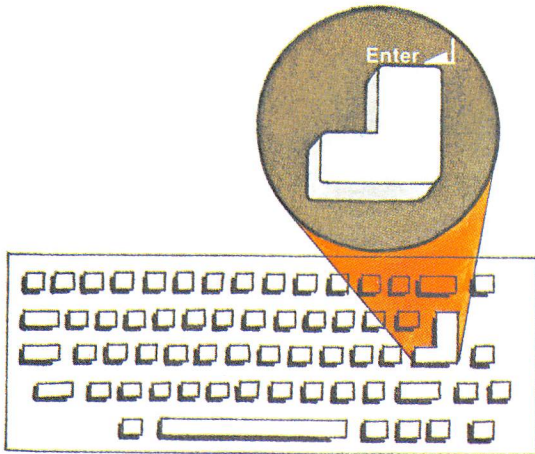

Remember the strange object in the upper left corner of the last screen? Do you remember how it disappeared from the screen when P.C. moved through it? That object was the Enter key. It was the key that allowed P.C. to "enter" into the next adventure by opening the box.

Just as it helped P.C. enter the box, the Enter key will do special things for you. It will carry your messages to the computer and allow you to give the computer a command or deposit information into its memory.

Let's use it now.



Press the Enter key and watch the top of your screen.

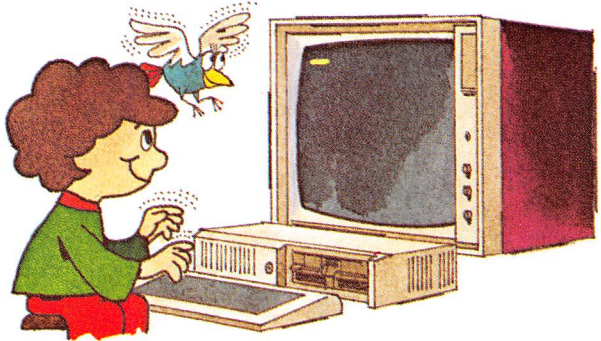

What happened to your name??? The printing is gone, and the cursor is back at the upper left corner of your screen. Don't worry, though. It isn't lost forever. The Enter key just "entered" your name into the computer's memory. Later, after we introduce more of the keys, we'll show you what a good memory the computer really has.

The next few keys you will use confuse some people. These are the keys that give you the lowercase "o", the uppercase "O", and the zero. Let's look at them on the screen.



Press the zero (0) key. It is on the top row of your keyboard next to the 9 key.

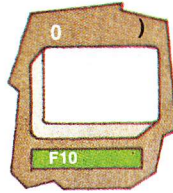

After P.C. places the zero (0) key on the screen keyboard, look at the screen. Notice that the zero has a diagonal line through it.



Now, press the key with the letter "O" above it. It is just under the zero key on your keyboard.

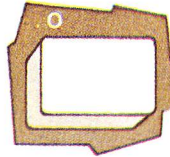

Do these look different to you? Look closely. There is no diagonal line in the lowercase letter "o" on your screen. Also the lowercase letter "o" is smaller than the zero.

Now, locate either one of the Shift keys.



Hold down one of the Shift keys, and, at the same time, type the letter "O".

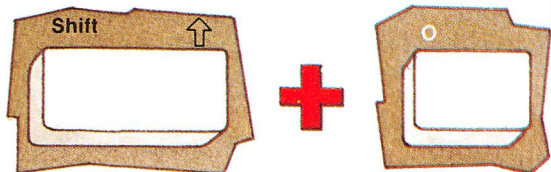

Look at the screen. You should see the uppercase letter "O". Notice there is no diagonal line in it, either.

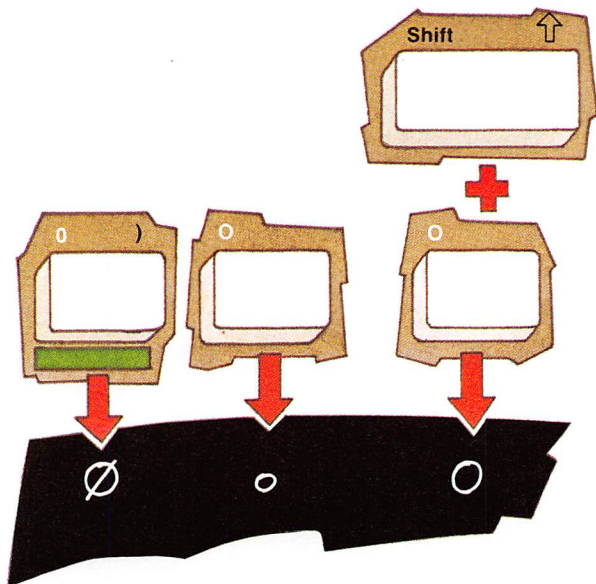

Let's take a look at two other keys that may be confusing because they look so much alike. These are the lowercase letter "l" key and the number "1" key. We are going to show you the difference between them.



Press the key with the letter "l" on it. It is just under the letter "O" key.

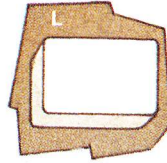

Press the number one (1) key. It is on the top row of the keyboard.

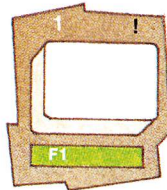

Notice that the lowercase letter "l" is thinner than the number "1".

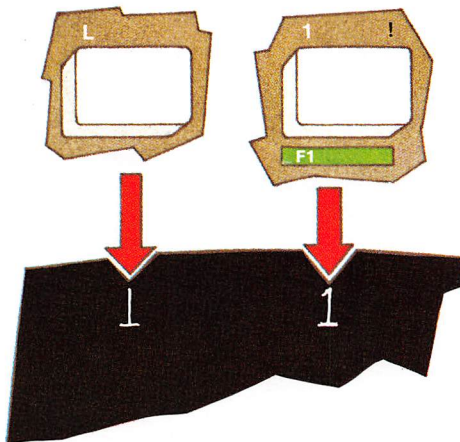

In the future, make sure you don't use the uppercase letter "O" or lowercase letter "o" for the zero "0." Also don't use the lowercase letter "l" for the number "1". This can be especially important to you later when you write your own computer programs. The computer knows which is which, so you can't fool it!

A really great feature of your IBM PCjr keys is that they will repeat if they are held down. This feature is called **typematic**. We'll prove it to you.



Hold down the zero (0) key.

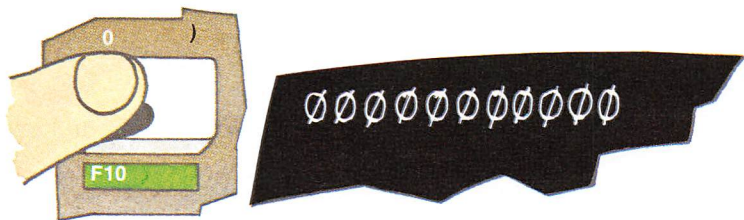

Look at the row of zeros you've just made! (Be careful, not to hold a key down too long unless you really want what you just typed to be repeated.)

Let's now take a look at a misunderstood key. It is just above the Enter key and has a left arrow above it.

Do you see it? It is called the Backspace key.



Now, press the Backspace key.

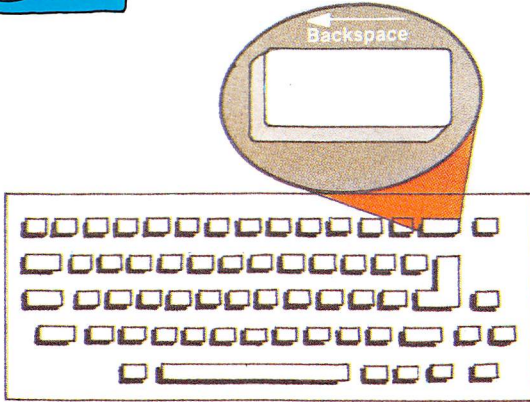

After P.C. has placed the key on the screen keyboard, let's see what it does.



Press the Backspace key until the cursor returns to the top left of your screen.

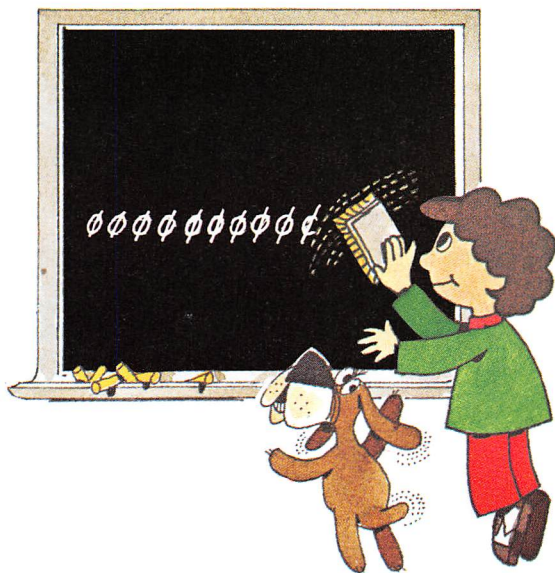

Notice that, as it moved backward, it erased all of the letters and numbers that were there.

The Backspace key is useful for erasing what is to the left of the cursor.

But, when you want to go back to correct an error you've made without losing the other characters you've printed on the screen, you must use the Cursor Left key, not the Backspace key.

Another key you should meet is the Space bar. It is the long bar at the bottom of your keyboard.

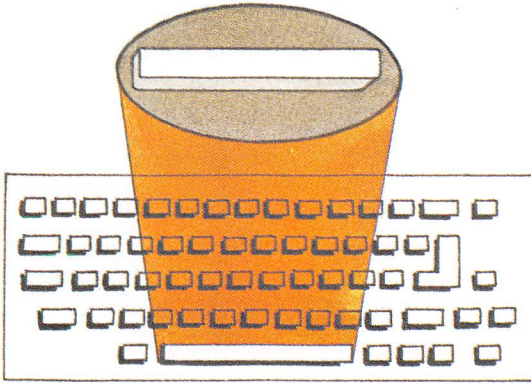

One thing to remember about the Space bar is that it erases as it moves forward. You should only use it when you want a space between characters.



Press the Space bar once and release it quickly. Now, watch the screen.

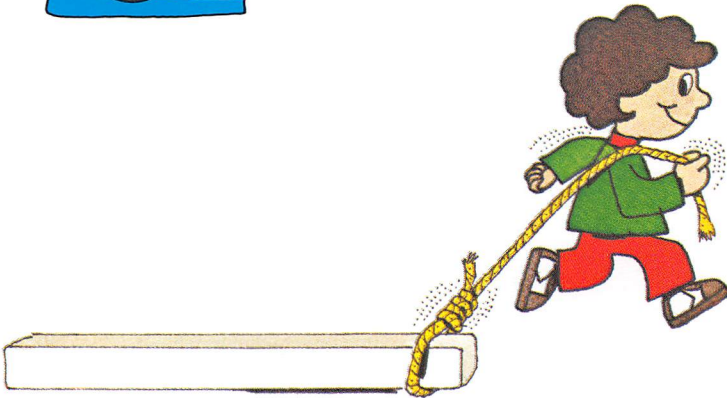

We had P.C. bring in the Space bar differently to show you that it looks unlike any other key on the keyboard.

Now, let's print something on the screen.



Type: P.C. is terrific. (Remember to press the Space bar after typing each word.)

If you type fast, you will have to wait until P.C. places the rest of the keys on the keyboard before all of the words appear on the screen.

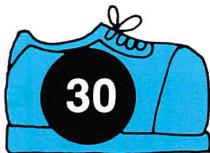

Now, hold down the Cursor Left key until the cursor moves back to the first letter on the line, and then release it.

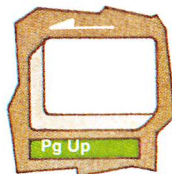

Now hold down the Space bar.



See how the Space bar erases the letters on the screen as it moves forward? (After erasing the letters, use the Backspace key to move the cursor back to the far left of the screen.)

We are now going to show you several keys that must be used with other keys to perform actions. One such key is the Alternate (Alt) key, and the other is the Function (Fn) key.



Press the Alt key. It is the key with a blue border around it - to the left of the Space bar.

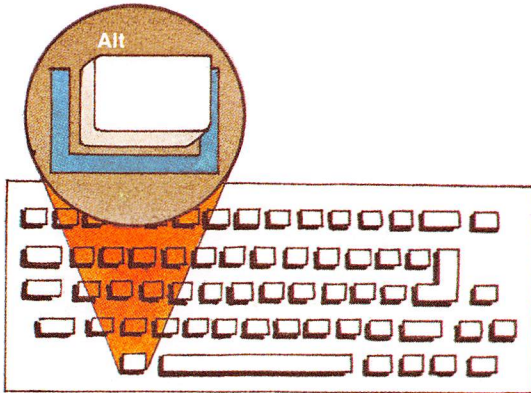

Did you notice that the screen turned blue? This happened to show you that any key with a blue stripe under it can be used with the Alt key to do special things. (We thought this would be an easy way for you to remember them.)

Now, let's see what happens when you press and hold the Alt key and press the Backslash key at the same time. (The Backslash key is located above the CapsLock key.)



Press and hold the Alt key and, at the same time, press the Backslash key.

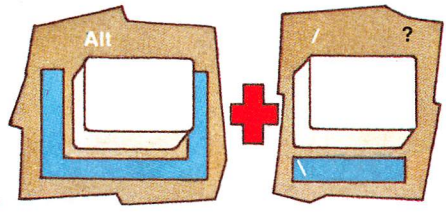

You should see a backslash printed on your screen. (If it is the backslash, it will look like the mark on the blue stripe under the key.)

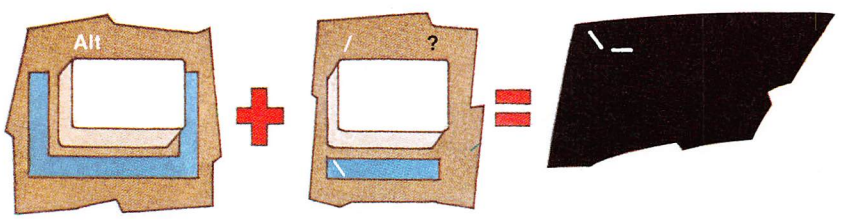

Just to show you what happens without the Alt key:



Press the Backslash separately.

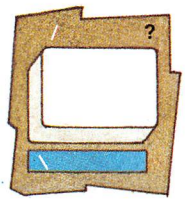

What you see on your screen now is a slash, not a backslash. (The slash is the mark on the upper left above the key.)

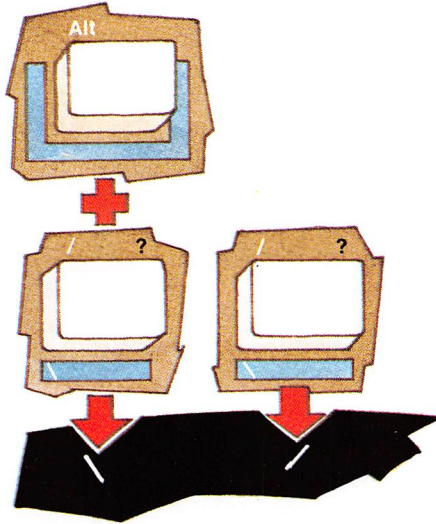

Let's look at the Fn key. Like the Alt key, it is used with other keys to do special things.

Are you ready for some surprises?

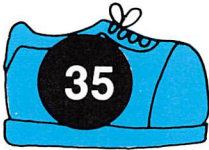

First, press the Fn key. It is the key with the green border around it - to the right of the Backspace key.

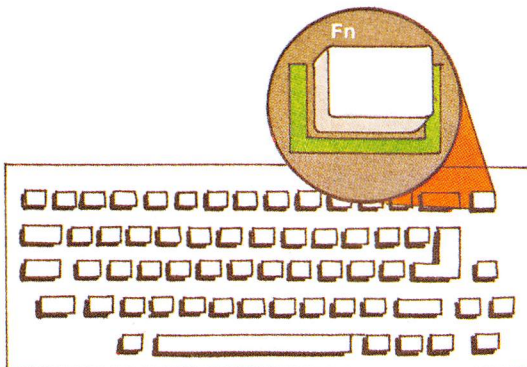

You've probably guessed that the screen turned green to show you that all keys used with the Fn key have a green stripe under them.

When any of the keys with green stripes under them are used with the Fn key to perform an action, that action is called a **function**. The keys are called **Function keys**.

We should tell you, though, that we've given these keys special functions only for this "Keyboard Adventure" program. Other computer programs you use will assign their own special meanings to these keys.

Are you ready to be entertained?

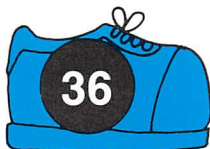

Press the Fn key and release it. Now press the F6 key.



Look at the screen. It should have changed color. Did it?

If you want to go back to the first color, press the Fn key, release it, and then press the F5 key.



Just for fun, press the Fn key; release it. Now press the F4 key.

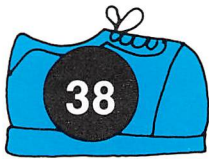
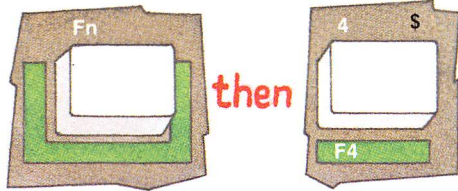

Press the Fn key; release it. Now press the F3 key.

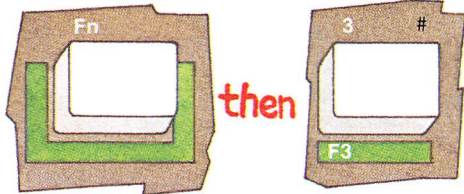

Pretty screens, weren't they?

Let's try another function key combination. This time:



Press the Fn key; release it. Now press the F2 key.

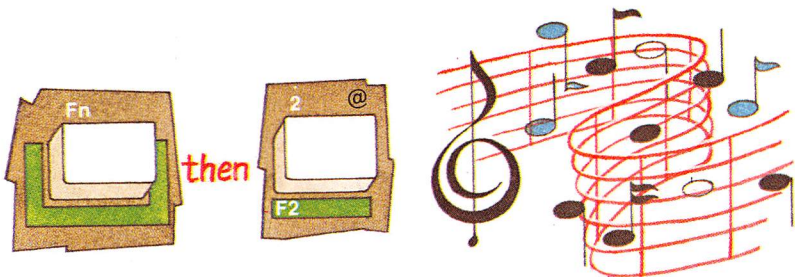

Amazing what you can do with these function keys!

If you would like to continue the music, just press the Fn key and F2 key again.

If you want to stop the music at any time, press the Fn key and then the Break key. This key combination is used when you want to stop a program that is running.

Let's do that now.



Press the Fn key; release it. Now press the Break key.

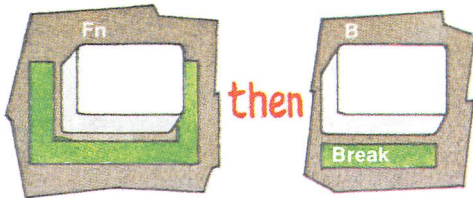

You just saw that the Fn key can also be used with special letter keys as well as number keys to perform functions.

By the way, remember when we told you that the computer had a good memory? We're going to prove that to you now.



Press the Fn key and then the F10 key. Now watch the top of your screen.

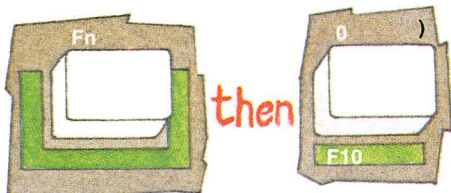

The Fn and F10 key combination brings back what was on your screen when you last pressed the Enter key.



TOMMY

If your name didn't reappear, you may have accidentally pressed the Enter key when something else was on the screen. In that case, type your name again now and press the Enter key. Then, press the Fn key followed by the F10 key.

For the next few minutes, let's watch P.C. finish building the keyboard. (Do you know that P.C. can remember up to 15 keys at one time! To prove it, try pressing one right after the other until you've pressed 15 keys.)

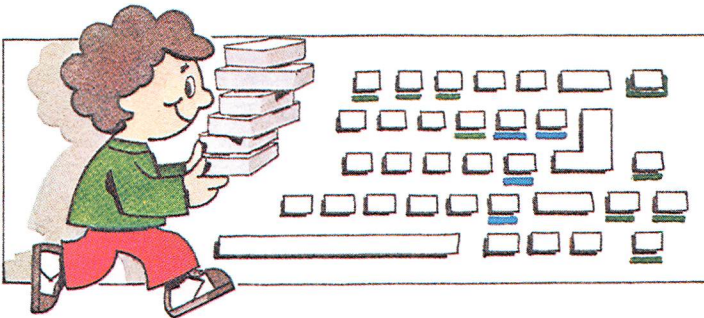



Press the rest of the keys in any order and as quickly as you like - but not more than 15 at one time.

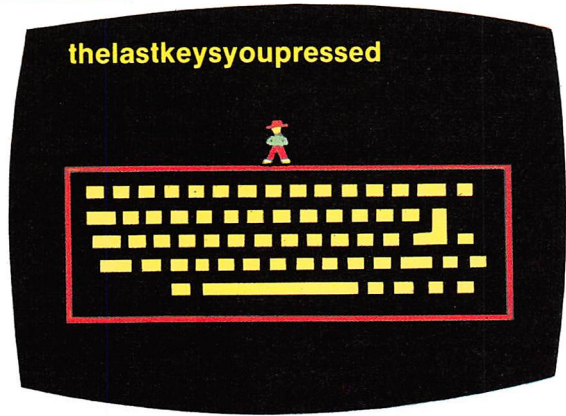

You should now have all of the keys in place on your screen keyboard. Just to make sure you do...

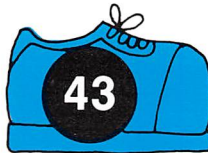

Press the Fn key and then the F7 key.

Pressing the Fn key and the F7 key brings in the rest of the keys (in case you've forgotten some).

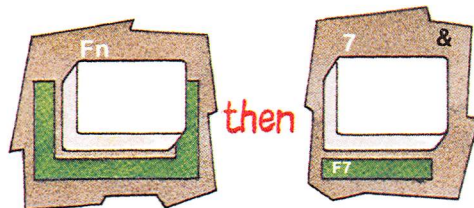

Now for another surprise:



Press the Fn key and then the F8 key.

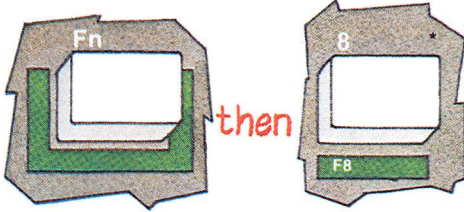

Press any one of the four cursor control keys.

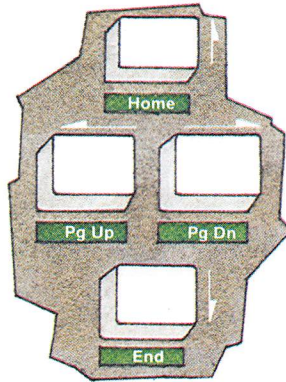

It looks like P.C. has come back to life!

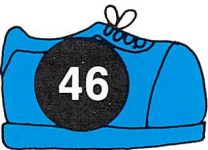

Move P.C. around the screen by using the cursor control keys.

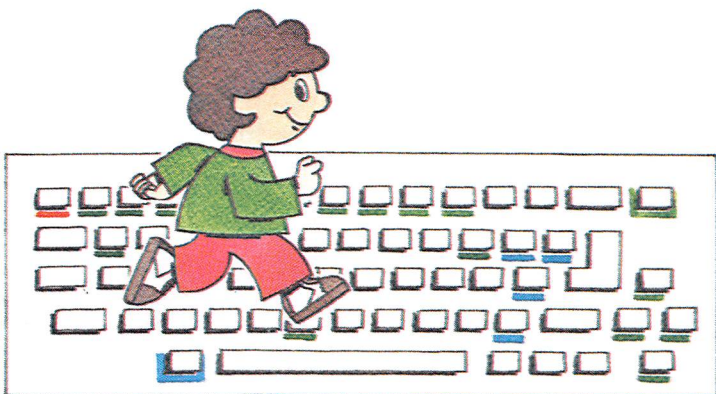

This is just like old times, isn't it, when P.C. was pretending he was a cursor.

To let P.C. rest, you would press the Fn key and F8 key again.



Press the Fn Key and then the F8 key a second time.

Now that the real cursor is back, you can do some typing for fun if you would like. Take as much time as you want. When you are ready to move on, turn to the next page.

Now that we've come to the end of this adventure, we're sure you'd like to know how it ends and how you can begin it again later.

If you wanted to go back from this point and start over, you would hold down one of the Shift keys and then press the Fn key and the F9 key. (Then you would begin again at Step 4 of the "Keyboard Adventure.")

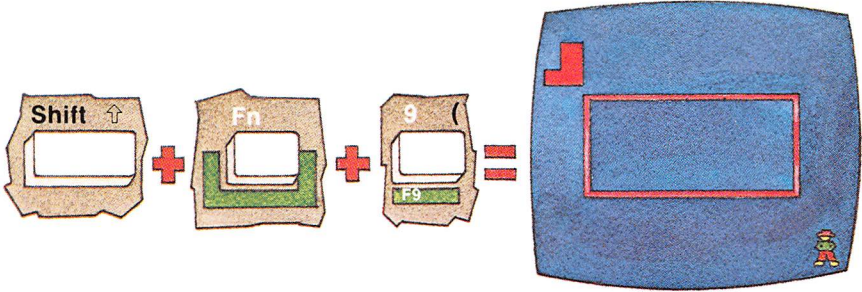

If you wanted to repeat only the keyboard part of this program, you would hold down one of the Shift keys and then press the Fn key and the F10 key. (Then you would begin again at Step 10 of the "Keyboard Adventure.")

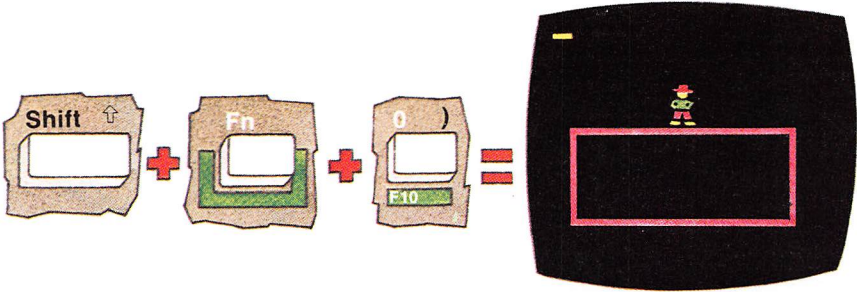

To exit the "Keyboard Adventure" entirely, you would press and hold the Control (Ctrl) and Alt keys while you press the Delete (Del) key. These keys are called **System Reset keys** because they restart your computer. You will learn more about them and the rest of the keys in the keyboard section of this book.

Let's exit from the "Keyboard Adventure" now.



To end the "Keyboard Adventure" program, press and hold the Ctrl and Alt keys while you press the Del Key.

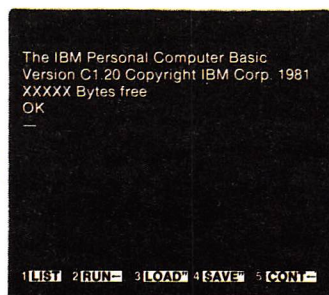
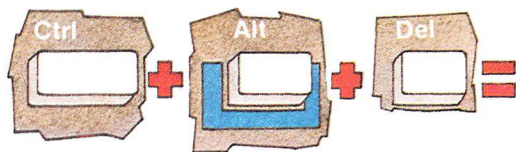

You should now have the "IBM Personal Computer" BASIC Message in front of you. (Of course, if you wanted to return to the "Keyboard Adventure" from this screen, you could always press the Esc key - just as you did to get here the first time.)

Now that your journey through the "Keyboard Adventure" is over, we hope you had fun and learned something, too. Feel free to come back for a visit anytime. The next time you join us, you may discover some secret adventures. Did we tell you what happens when you press the Fn and F1 key or the Shift + Fn + the F2 keys? If you want to find out about them, you'll just have to come back and experiment with the keyboard.

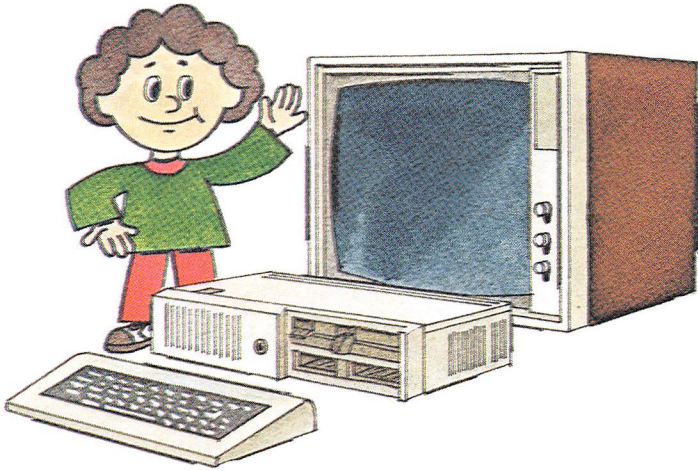

If you ever want to run the "Keyboard Adventure" again, you can do this by pressing the Esc key when the "IBM Personal Computer Basic Message Screen" appears. Remember, this is the screen that appears after you turn your IBM PC_{jr} power on.

Continue now with Section 3, "The Keyboard."

Notes:

SECTION 3. THE KEYBOARD

Contents

Introduction	3-3
Using the Keyboard	3-4
Centering the Information on the Screen	3-9
Keyboard Modes	3-13
System Reset	3-25
Additional Keyboard Features	3-26

Notes:



Introduction

This section shows you how to use your IBM PCjr keyboard to operate your IBM PCjr.

When you press a key, your keyboard sends a message to your IBM PCjr. The program you use tells your IBM PCjr what to do with that message. For instance, when you are playing a game, your "J" key may make a frog jump. But when you are using a program to write a letter to your friend, that same key simply types the letter "J".

Keyboard

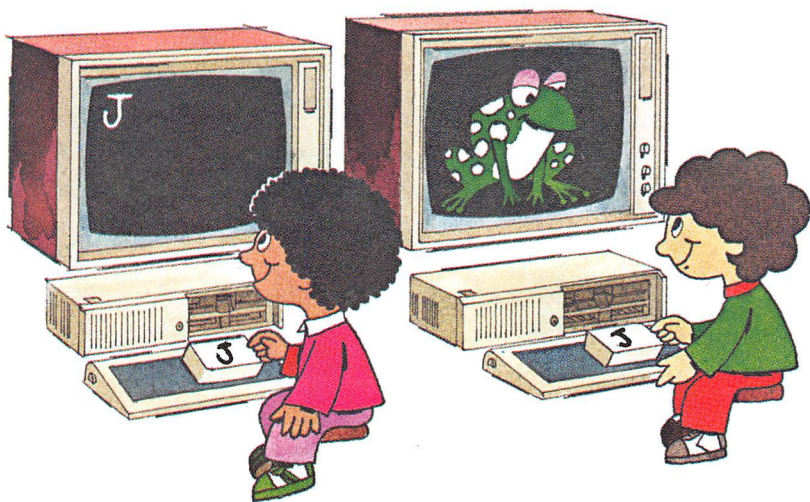

Using the Keyboard

All keys on the keyboard are **typematic**. This means that each key repeats as long as you hold the key down.

This is the keyboard that comes with your IBM PCjr.

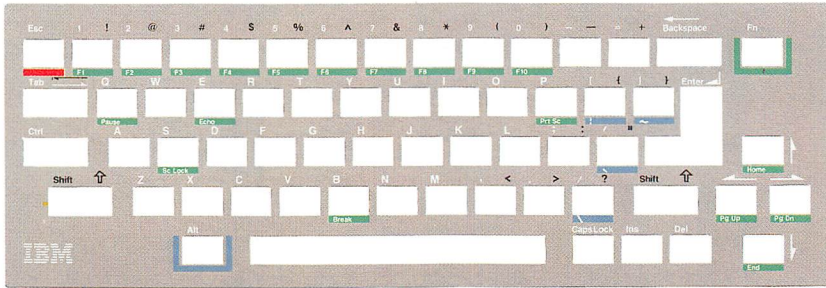

The positions of the keys are much like those of a standard typewriter. Most keys on the keyboard have an uppercase (capital) letter and a lowercase (small) letter.

Your keyboard has some extra keys that a typewriter doesn't have.

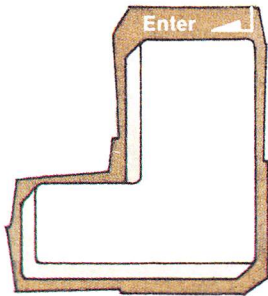

This is the Enter key.

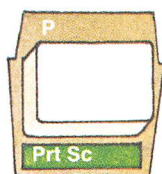

This is the Print Screen (Prt Sc) key. If you have a printer and you press the Fn key and then press the Prt Sc key, the printer prints a copy of the information that is on the screen.

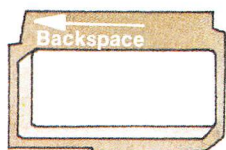

This is the Backspace (←) key. When pressed, it erases the character to the left of the cursor and moves the cursor one position to the left.

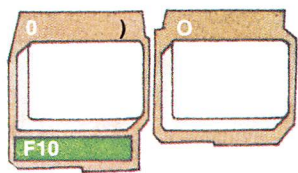

The zero "0" and the letter "O" are seen as two different characters by your IBM PCjr. The zero appears on your screen with a line through it. Do not use the zero when you want the letter "O" to appear.

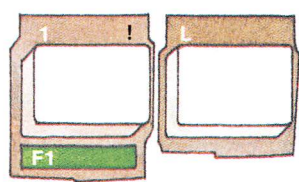

The number one "1" and the letter "l" are also seen as two different characters by your IBM PCjr. Do not use the number one (1) key when you want the letter "l" to appear.

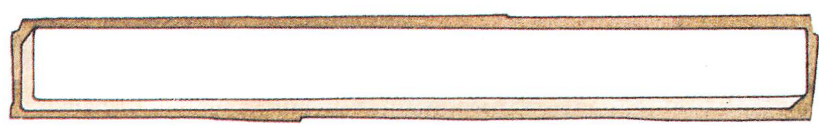

When pressed, the Space bar creates a blank on the screen and moves the cursor to the right.

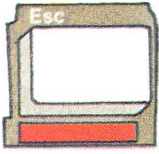

This is the Escape (Esc) key.

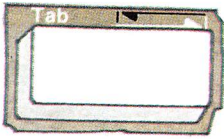

This is the Tab key.

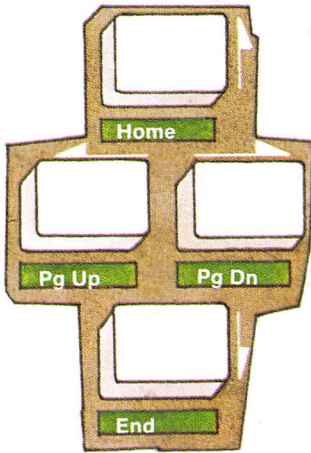

These are the cursor control keys.

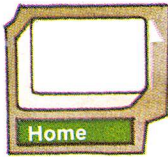

In most programs, the Cursor Up key moves the cursor one line up.

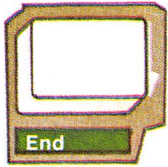

In most programs, the Cursor Down key moves the cursor one line down.

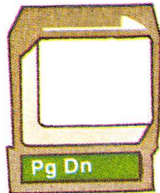

In most programs, the Cursor Right key moves the cursor one position to the right.

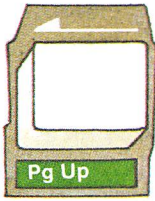

In most programs, the Cursor Left key moves the cursor one position to the left.

Centering the Information on the Screen

If the writing on your screen is not centered, you can move it.

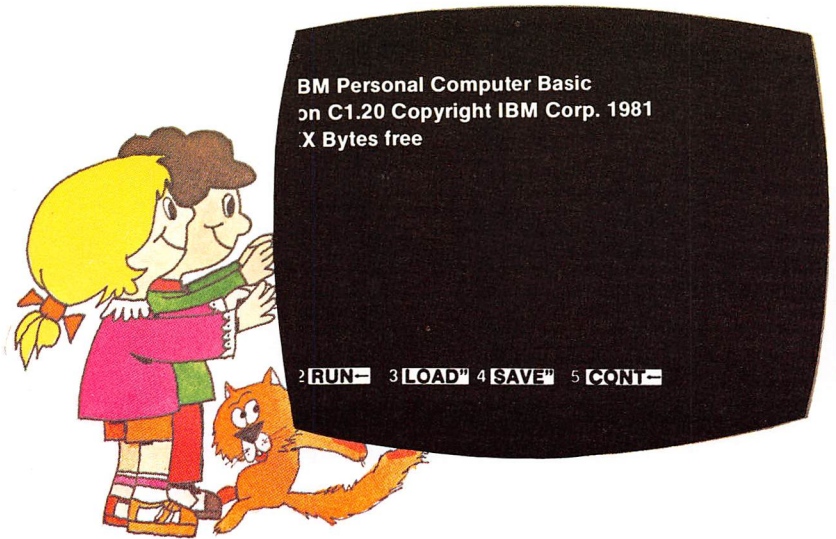

Keyboard

The writing on this screen needs to be moved to the right.

If the writing on your display's screen needs to be moved to the right, you can do this by pressing and holding

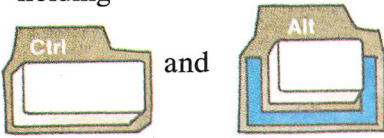

and then pressing



Each time you press the cursor right key while holding Ctrl and Alt, the writing on the screen moves one space to the right.

When the writing on the screen is centered, release all three keys.

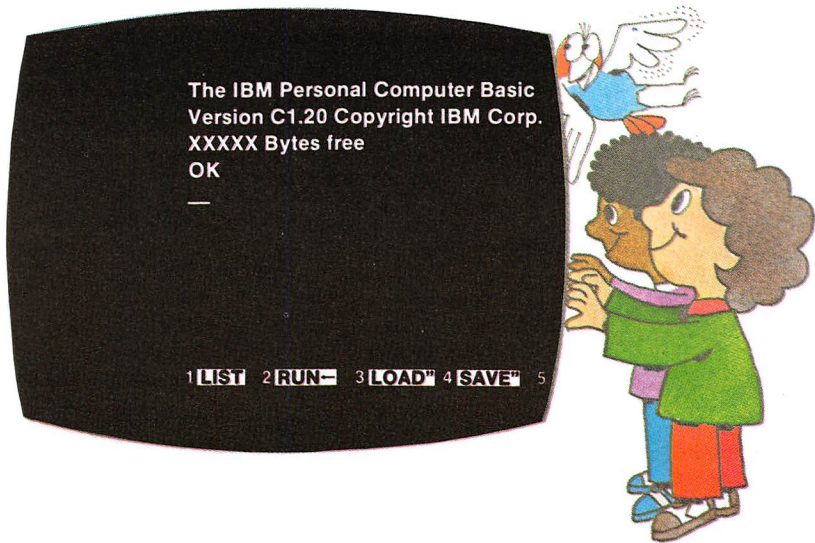

The writing on this screen needs to be moved to the left. If the writing on your display's screen needs to be moved to the left, you can do this by pressing and holding

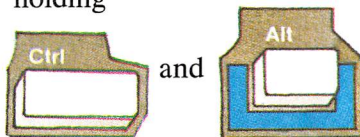

and then pressing



Each time you press the cursor left key while holding Ctrl and Alt, the writing on the screen moves one space to the left.

Notes:



Keyboard Modes

The keyboard can be placed into these modes:

- Regular mode
- Shift mode
- CapsLock mode
- Alternate mode
- Control mode
- Function mode

Let's see how the keys change for each of these modes.

Regular Mode



When you turn your IBM PCjr power on, the keyboard is in the Regular mode. The keyboard remains in the Regular mode until you change that mode. Regular mode means that all alphabetic keys are in lowercase.

Shift Mode

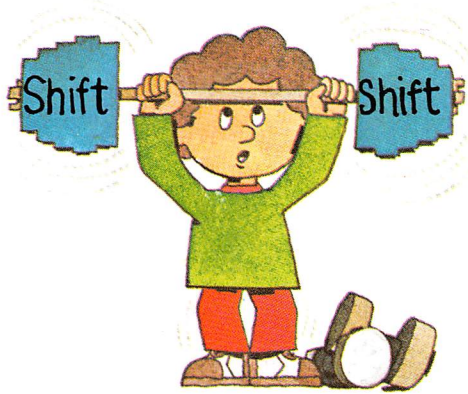

There are two shift keys on your keyboard. In the Shift mode, all keys type in uppercase.

To put the keyboard into the Shift mode, press and hold either Shift key and then press the key you have chosen to work with it.

The key you have chosen must be pressed while the Shift key is held down.

Shift mode ends and Regular mode returns when you remove your finger from the Shift key.

When you first turn your IBM PC_{jr} power on, the IBM Personal Computer BASIC Message Screen appeared. Using this screen and the following instructions try your keyboard.

Remember, when you first turn your IBM PCjr power on, your keyboard is in lowercase.

Some keys have both a white and a black character above them.

The white character above the keys shows the lowercase numbers and symbols.

The black character above the keys shows the uppercase symbols.

For instance, look at the key in the top row marked

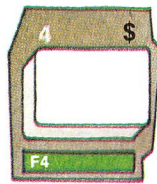

Press it.

The number "4" appears on the screen.

Now press and hold down a

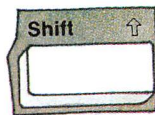

key.

Then press

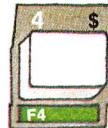

A \$ now appears.

CapsLock Mode

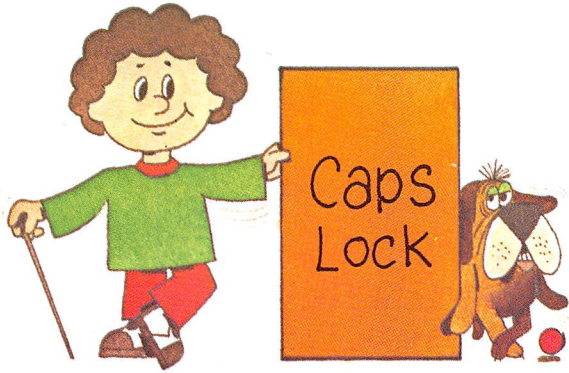

To put the keyboard into the CapsLock mode, press the CapsLock key once and release it.

In the CapsLock mode, the letters A through Z appear in uppercase.

The keyboard stays in the CapsLock mode until you press CapsLock again.

If you want to type a lowercase letter or a black symbol, while the keyboard is in the CapsLock mode, you have to press the Shift key.

You can type lowercase characters while in the CapsLock mode by pressing and holding the Shift key and then pressing the key for the character you have chosen to appear in lowercase.

To cancel the CapsLock mode, press CapsLock again and release it. Your keyboard then returns to the Regular mode.



Alternate Mode

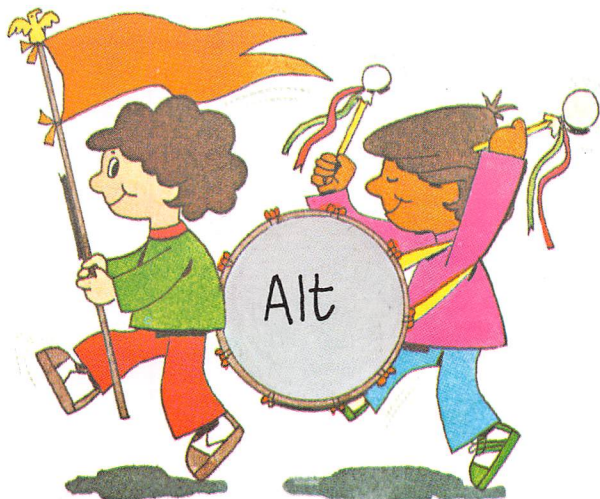

In the Alternate mode, some keys will display different symbols when used in combination with the Alternate (Alt) key.

Notice that the Alt key has a blue border. All of the keys used with the Alt key are marked with a blue stripe underneath them. The symbols displayed by using these keys with the Alt key are shown in the blue stripes below the keys.

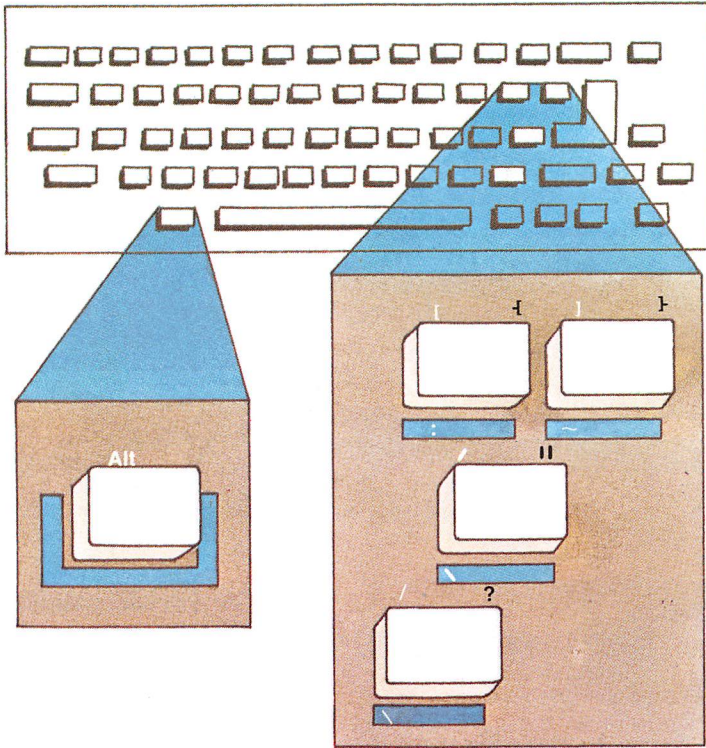

The key you have chosen to use with Alt must be pressed while the Alt key is held down.

Alternate mode ends when you stop pressing the Alt key. Your keyboard then returns to the Regular mode.

Control Mode



The Control key (Ctrl) on the left side of your keyboard performs functions that are determined by the program you use. To put the keyboard in Control Mode, press and hold the Control key and then press the key you have chosen to work with it. Control Mode ends when you stop pressing the Ctrl key.

Function Mode



The border around the Function (Fn) key is green. When you press the Fn key, the keyboard waits for you to press one of the keys with a green stripe underneath it. The number of the function each key performs is shown in the green stripe underneath the key. The program you are using determines what that key does.

To use the Function mode, first press and release the Fn key. Then press the green striped key you desire. After you press the green striped key, the Function mode is canceled.

If you have more than one function to perform, you may press and hold the Fn key while pressing the other green striped keys.

If you press the Fn key by accident, press the Shift key to cancel the Function mode.

You can lock your keyboard in the Function mode by pressing and holding the Shift and Fn keys and then pressing the Esc key. When locked in the Function mode, all keys with green stripes perform their functions without needing the Fn key pressed first. To unlock the Function mode, press and hold Shift and Fn and then press Esc.

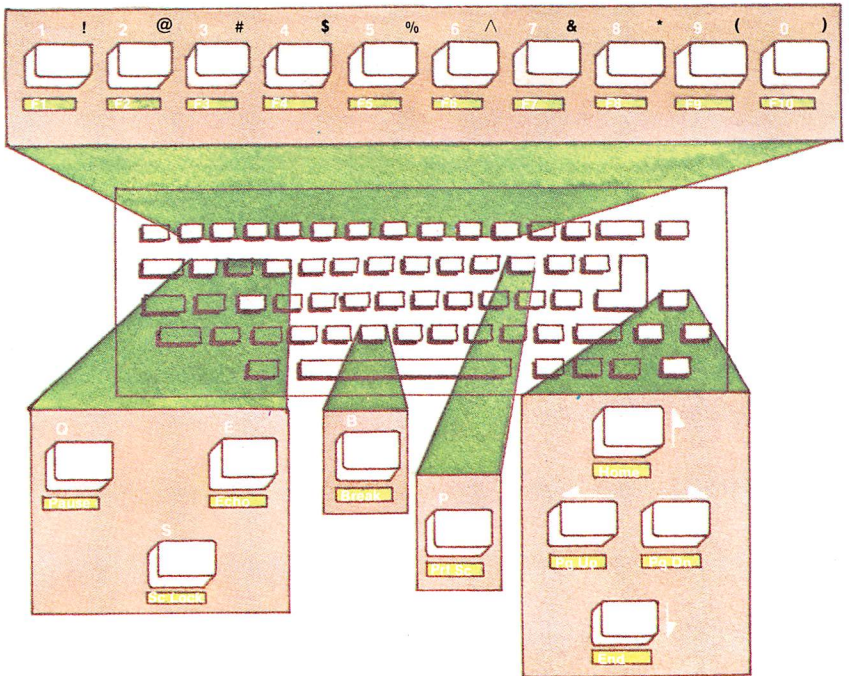

Notes:

System Reset

While using your IBM PCjr there will be many times that you will want to perform a system reset or (reset), (reset and system reset mean the same thing).

There are two ways to reset your IBM PCjr while you are using it. The first way is to turn your IBM PCjr power off, wait five seconds, then turn power on. The second way is to use your keyboard, follow the illustration shown below.

Press and hold

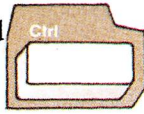

and

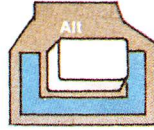

Then press

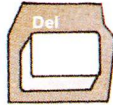

Release all three keys.

Some things that you might use a reset for are:

- 1 Starting a program over again.
- 2 Loading a program from a diskette.

Additional Keyboard Features

Keyboard Legs

Your IBM PCjr keyboard is equipped with adjustable legs. You can find the position that is comfortable to you, by typing on the keyboard with the legs up and then down.

Keyboard Clicker

Your IBM PCjr has a feature called the Keyboard Clicker. When this feature is turned on, every time you press a key you will hear a clicking sound. To turn the Keyboard Clicker on press and hold CTRL and ALT and then press CapsLock. To turn the clicker off press and hold CTRL and ALT and then press CapsLock.

Continue with Section 4, "Choosing Keys".

SECTION 4. CHOOSING KEYS

Contents

Introduction	4-3
When to Use the Keyboard Differences Chart	4-5
Using the Keyboard Difference Chart	4-6
Keyboard Difference Chart	4-9

Notes:

Introduction

Some program books were written to be used with an IBM Personal Computer keyboard. You can still use these programs and their books with your IBM PCjr and its keyboard. This section shows you the differences between your keyboard and the IBM Personal Computer keyboard.

Use this section as a guide when running a program written to be used with an IBM Personal Computer keyboard.

If you have a diskette drive installed you may run your "Exploring the IBM PCjr" diskette, which is located in the back of the *Guide to Operations* binder. For information on how to operate your diskette drive, refer to the operating instructions in the Diskette Drive Option Installation and Operating Instructions in Section 5.

If you have any options to install, install them now. The carton that your option is packed in contains the instructions for installing your option.

If you do not have any options to install go to Section 7, "Cartridges".

Notes:

When to Use the Keyboard Differences Chart

Before you begin to use one of your programs, look at the book that comes with it. If your program book refers to keys on the IBM Personal Computer keyboard, use the Keyboard Difference Chart.

If your program book refers to the IBM PCjr keyboard you will not have to refer to the keyboard chart.

The following pages explain the use of this chart.



Using the Keyboard Difference Chart

Let's take a few minutes to learn how to use the Keyboard Difference Chart. You will be surprised how easy it is to tell which keys you should use.

Suppose you are using a program with a book written for an IBM Personal Computer keyboard. You decide to print your file and the program book tells you to do this by pressing the F2 key.

Even though you see an F2 key on your keyboard, it will not work the way the program book describes. The book is not referring to the IBM PC*jr* keyboard. Go to your Keyboard Difference Chart.

The left column lists the keys on the IBM Personal Computer keyboard. The right column lists the keys you should use to get the same results on your IBM PC*jr* keyboard.

Your program has instructed you to use F2, so you need to find F2 in the left column of the chart.

Now look across the page to the IBM PCjr keyboard column. You will see "Fn then F2" in green. This means that, on your IBM PCjr keyboard, you press the green bordered Function key to go into the Function mode and then press the key with the green stripe and F2 underneath it. This is the same as pressing the F2 key on the IBM Personal Computer keyboard.

Pressing **F2** on the IBM Personal Computer keyboard

is the same as pressing

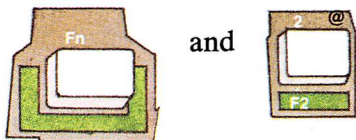

on the IBM PCjr keyboard

OK, let's suppose you are using a program that tells you to press Ctrl/Break.



Control Break will not work the way the program book describes. The book is not referring to the IBM PCjr keyboard.

Look at your Keyboard Difference Chart.

In the left column, you see "Ctrl/Break (or Break)". If you follow that line over to the IBM PC_{jr} keyboard column, you see that you get Ctrl/Break by pressing the green bordered Fn key and the Break key with the green stripe.

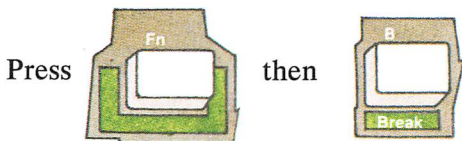

That's all there is to it! You may want to spend some time looking at the chart until you feel comfortable with it. Most of the key combinations are color coded on your keyboard.

This chart has been reproduced on a card in the front of this book. You can put this card beside your IBM PC_{jr} when you are using programs written for an IBM Personal Computer keyboard.

Keyboard Difference Chart

IBM Personal Computer Keys and Key Combinations

Cordless Keyboard Equivalent Keys and Key Combinations

F1	Fn	then	F1
F2	Fn	then	F2
F3	Fn	then	F3
F4	Fn	then	F4
F5	Fn	then	F5
F6	Fn	then	F6
F7	Fn	then	F7
F8	Fn	then	F8
F9	Fn	then	F9
F10	Fn	then	F10
Shift/F1 thru F10	Hold Shift Press Fn	then	F1 thru F10
Ctrl/F1 thru F10	Hold Ctrl Press Fn	then	F1 thru F10
Alt/F1 thru F10	Hold Alt Press Fn	then	F1 thru F10
Ctrl/Break (or Break)	Fn	then	Break
Ctrl/End	Ctrl with Fn	then	End
Ctrl/PrtSc (Echo Print)	Fn	then	Echo
Ctrl/Home	Ctrl with Fn	then	Home
Ctrl/Num Lock (Pause)	Fn	then	Pause
Ctrl/PgDn	Ctrl with Fn	then	Pg Dn
Ctrl/PgUp	Ctrl with Fn	then	Pg Up
Shift/PrtSc (Print Screen)	Fn	then	Prt Sc
Scroll Lock	Fn	then	Sc Lock
Num Lock	Hold Alt Press Fn	then	N
PgUp	Fn	then	Pg Up
PgDn	Fn	then	Pg Dn
Home	Fn	then	Home
End	Fn	then	End
\	Alt	with	/
'	Alt	with	'
	Alt	with	[
~	Alt	with]
↵	Enter		
All 256 extended codes	Num Lock Hold Alt	then	Numeric Value

Notes:

SECTION 5. THE IBM PC^{jr} OPTIONS

Contents

Instructions	5-3
--------------------	-----

Notes:

Instructions

Insert the instructions you receive with options into this section. Notice the black tabs on the right edge of the next page. Each set of option information also has a black tab on the right side. As you install an option, insert the information you receive with it behind the matching black tab on the next page, as shown below.

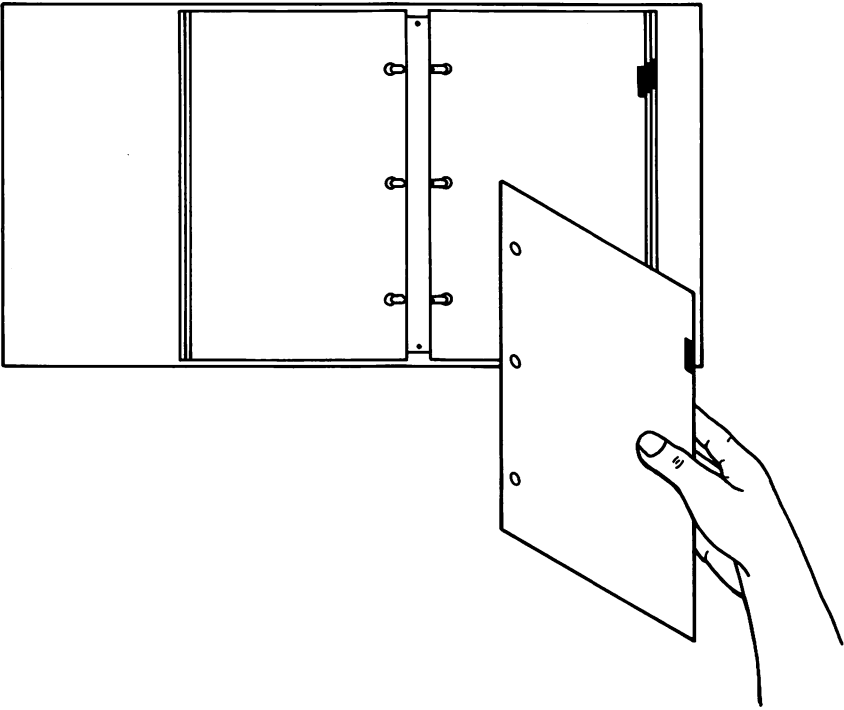

Notes:



Display

Printer

Diskette

Memory

General

Notes:



IBM PCjr Diskette Drive Installation and Operating Instructions

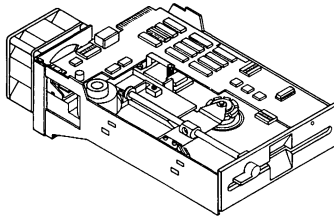
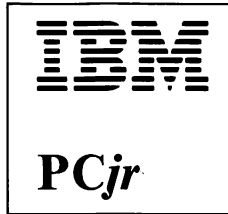

If your IBM PCjr has not been set up at this time, do so before installing this option.

This carton contains the following:

- Diskette drive
- Signal cable
- Power cable
- Diskette adapter
- "Exploring the IBM PCjr" diskette

If any items are missing or damaged, notify your place of purchase.

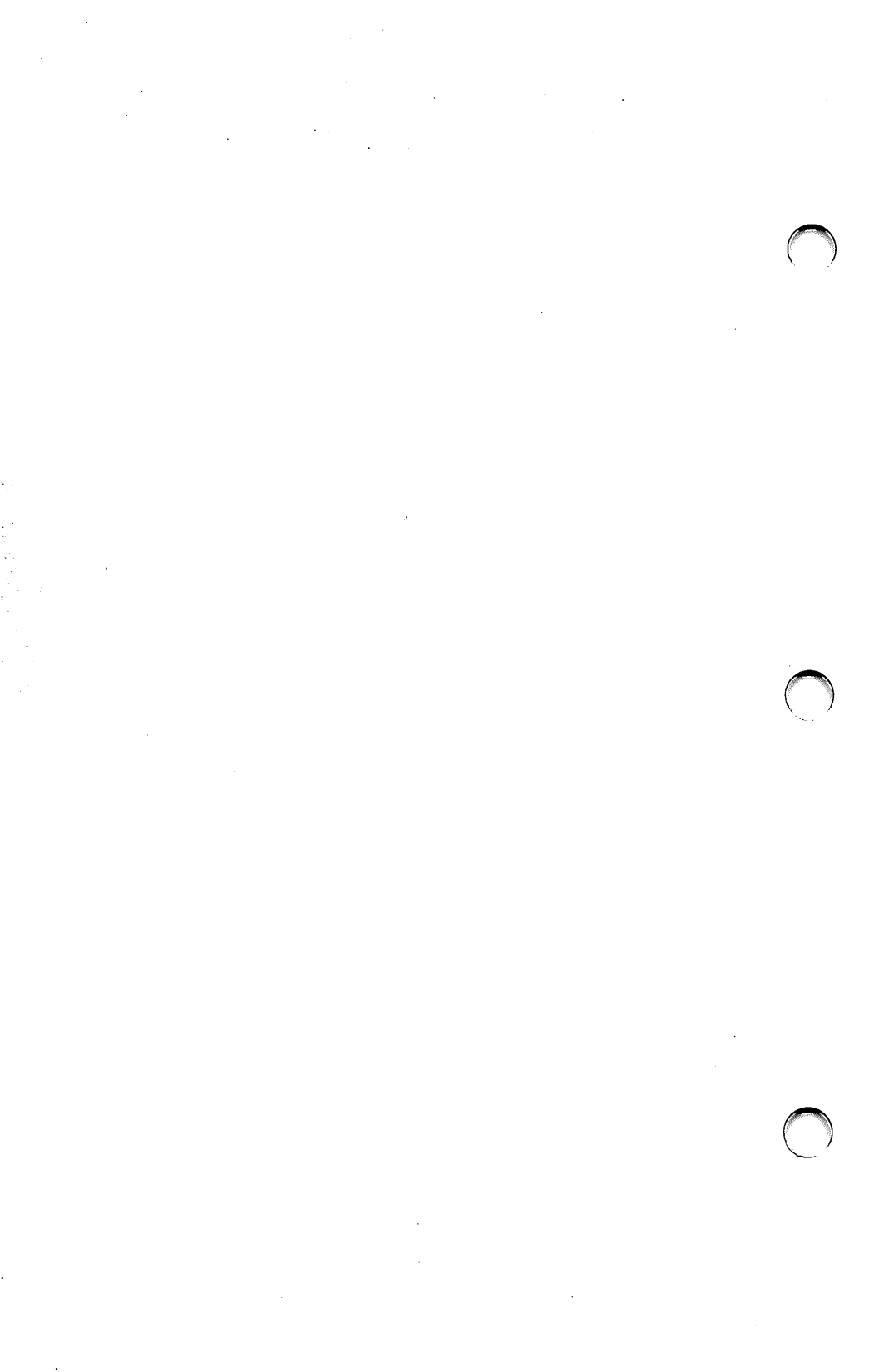

Contents

Installation Requirements	2
Tools Required	2
Installation Instructions	3
Operating Your Diskette Drive	19
How to Insert and Remove Diskettes	19
Write Protect	21
Starting a Program Diskette	22

Installation Requirements

If your IBM PCjr has not been set up at this time, do so before installing this option.

Tools Required

- Medium-size, flat-blade screwdriver

Installation Instructions

- 1** Turn your IBM PCjr power off.
- 2** Turn all external option power off (printer, TV, cassette, etc.).
- 3** Unplug the power cords for the IBM PCjr and all options from the wall outlets.
- 4** Turn your IBM PCjr so the rear is toward you.

CAUTION

Serious shock hazards exist within the covers of the IBM PCjr. Do not open these covers unless you have unplugged your IBM PCjr power cord from the wall outlet.

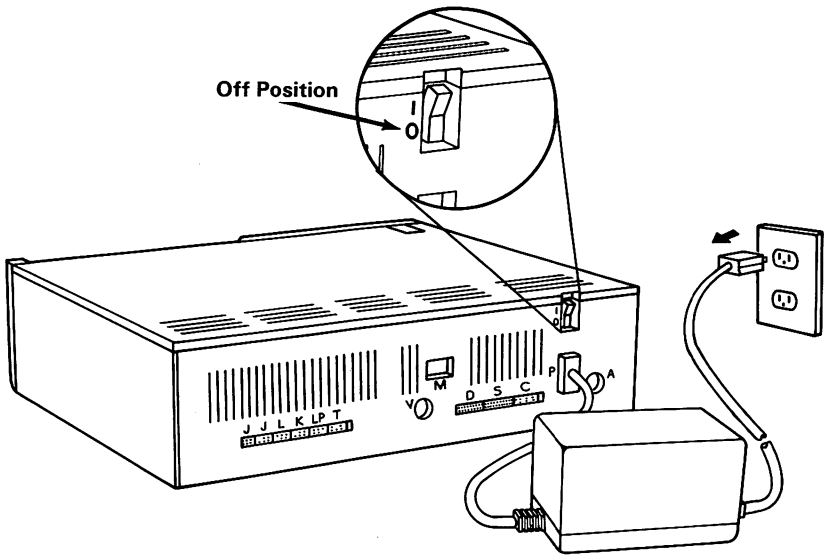

Warning: After turning your IBM PCjr power off, allow 5 minutes for cooling to take place before removing the cover.

- 5** Place a flat-blade screwdriver into the slots and twist.
- 6** Remove the top cover by lifting it up and away from the front of the IBM PCjr.

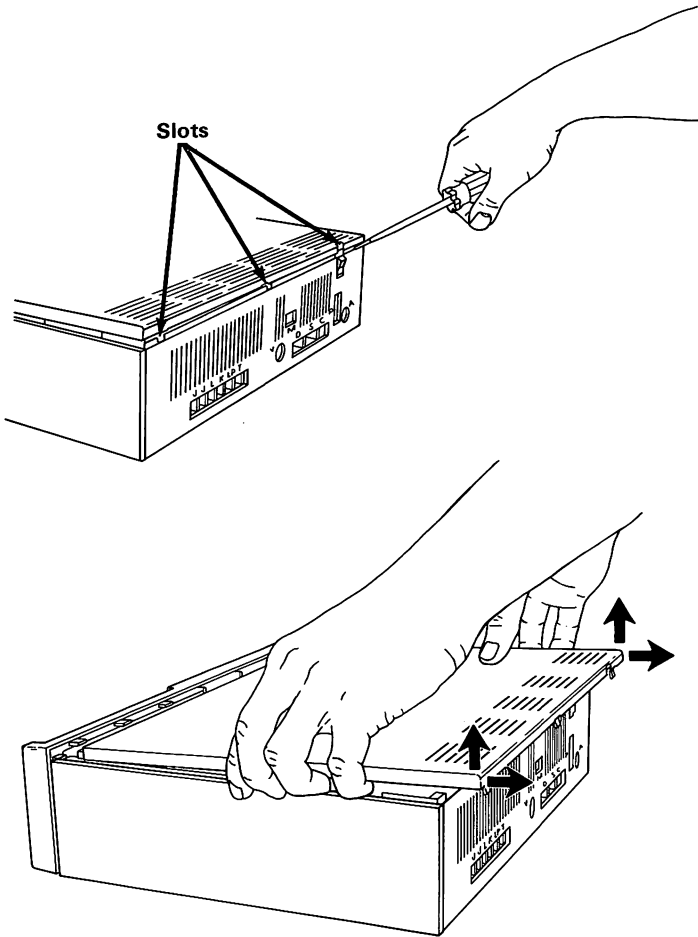

- 7** Remove diskette face plate by pushing on it from inside the IBM PCjr. It will snap out.

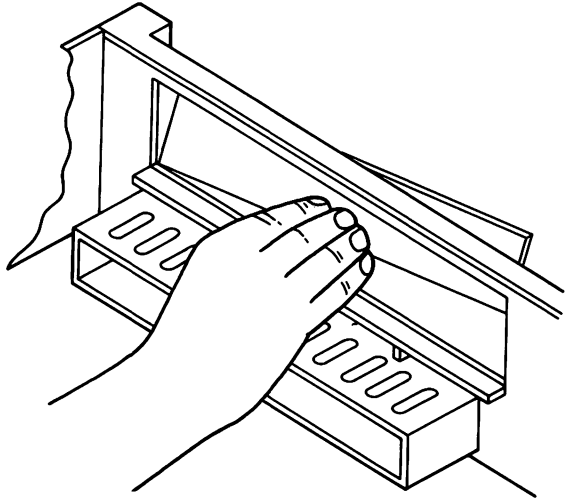

- 8** Turn your IBM PCjr so the front is toward you.
- 9** Remove the power board by gently pulling it straight up.
- 10** If your system has the IBM PCjr 64KB Memory and Display Expansion Option or the IBM PCjr Internal Modem Option installed, they must be removed to continue with this option installation. Remove them by gently pulling them straight up.

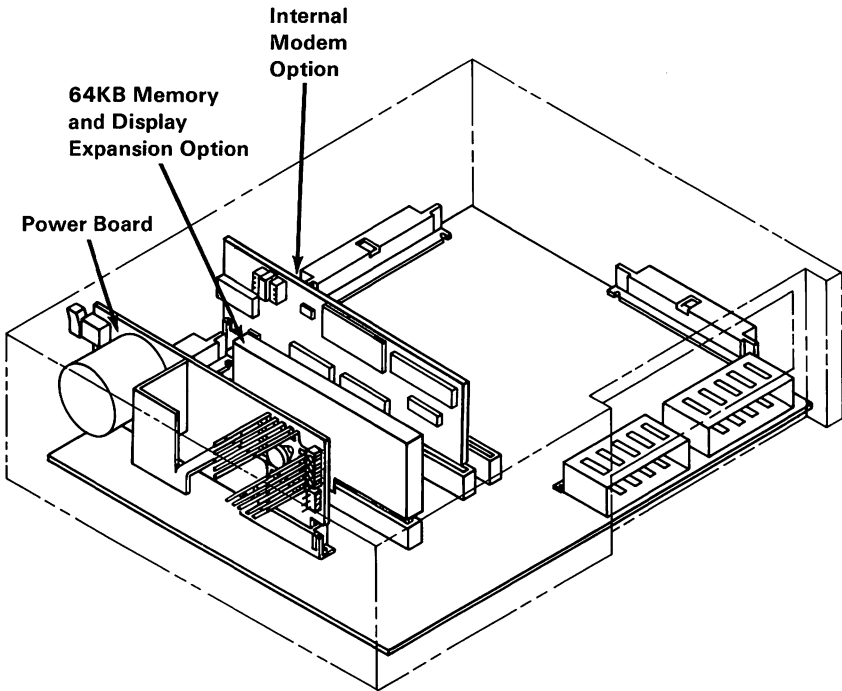

- 11** Unpack the power cable from its box. Plug the power cable into its connector on the diskette drive.

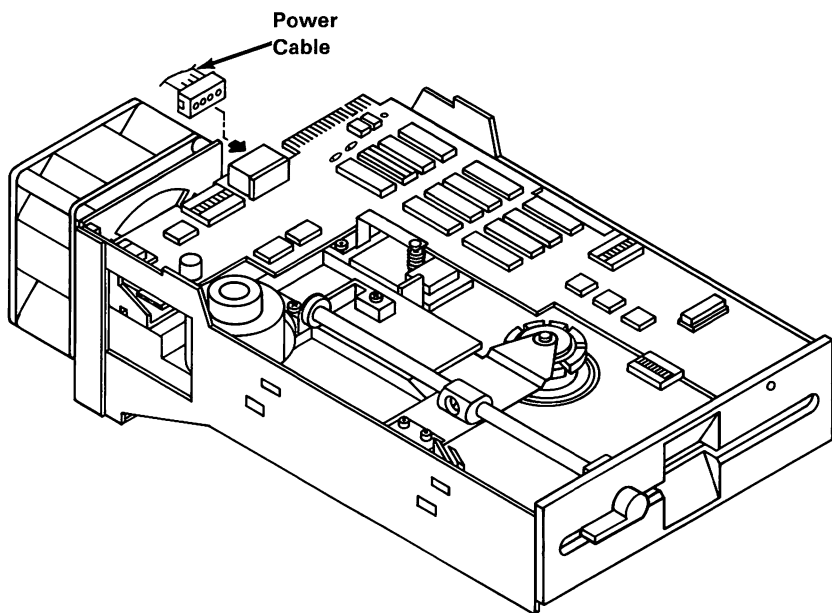

Diskette

- 12** Unpack the signal cable from its box. Plug the folded end of the signal cable into its connector on the diskette drive. Be sure to align the guide correctly.

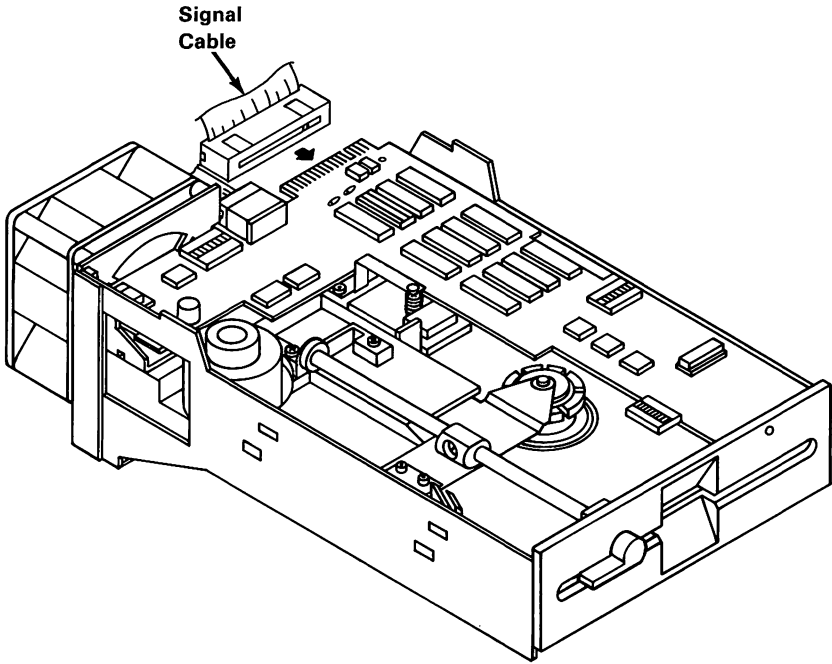

- 13** Place the signal cable on the top of the diskette drive. Place the diskette drive and fan power cables underneath and out the side of the diskette drive unit.

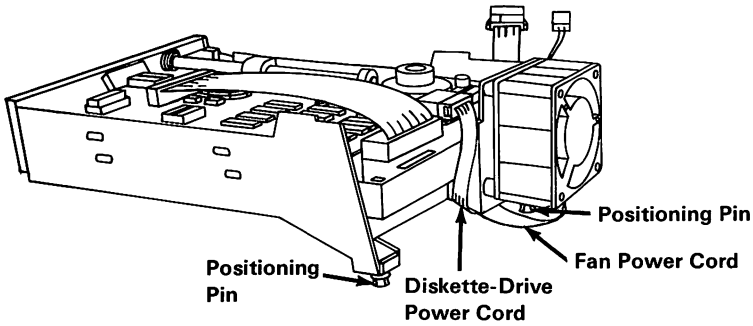

- 14** Place the diskette drive unit into the IBM PCjr. Make sure the front guide goes into the front panel slot.

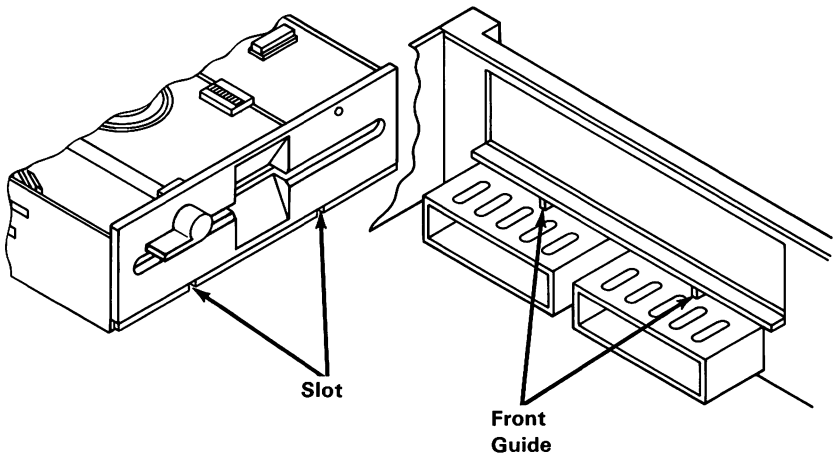

- 15** Align the mounting pins with the mounting holes. Press down on the rear of the diskette drive until it snaps into place.

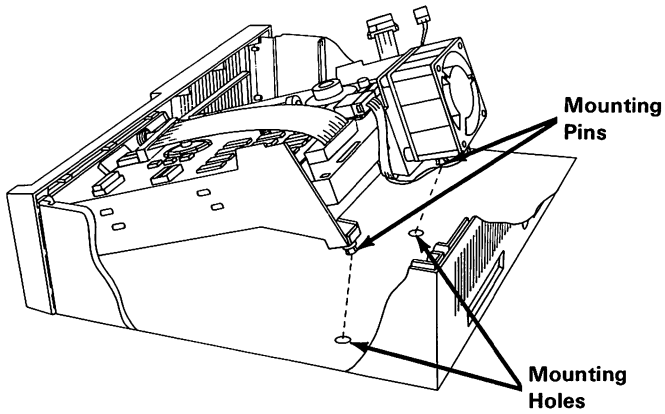

- 16** Position the diskette drive and fan power cables as shown below.

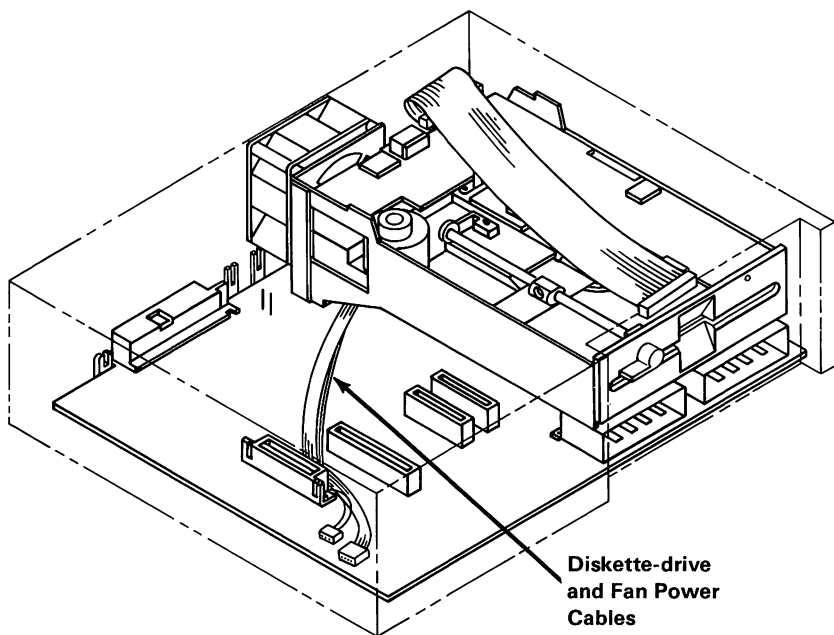

- 17** Position the power board so that its system connector and two pin connectors are directly above its system slot and two pin plug. Press it firmly into place. Be sure that the rear of the power board goes into the rear guide.

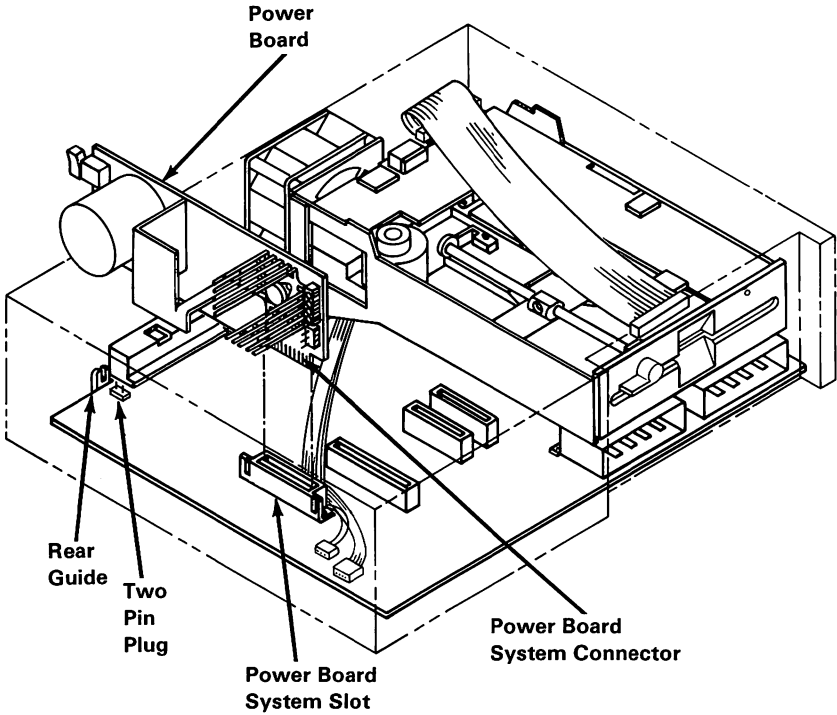

18 Plug the fan and the diskette drive power cables into their connectors.

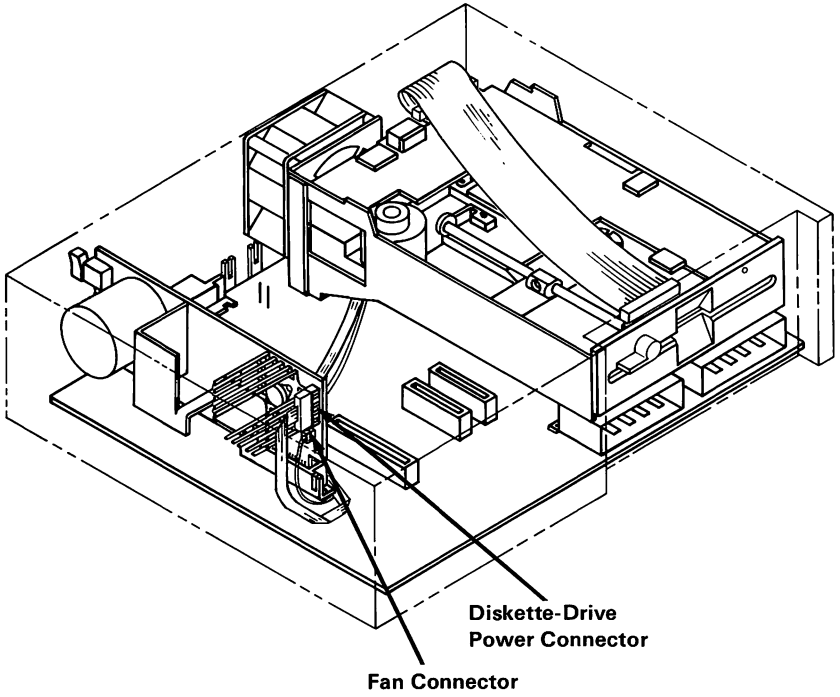

- 19** Plug the diskette drive signal cable into the connector on the diskette drive adapter. Be sure to align the pins and holes correctly.

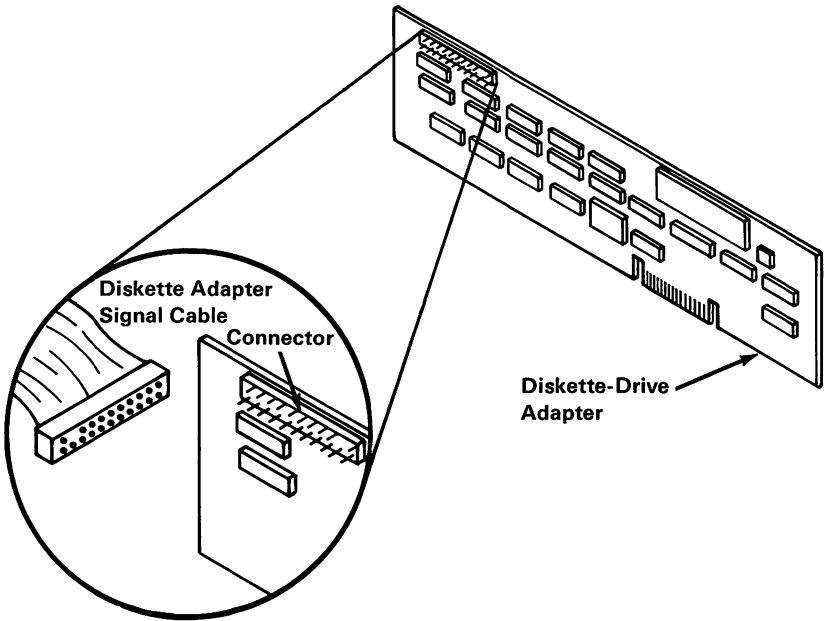

- 20** Position the diskette drive adapter so that its system connector is directly above its system slot, press it firmly into place. Be sure that the rear of the diskette drive adapter goes into the rear guide.

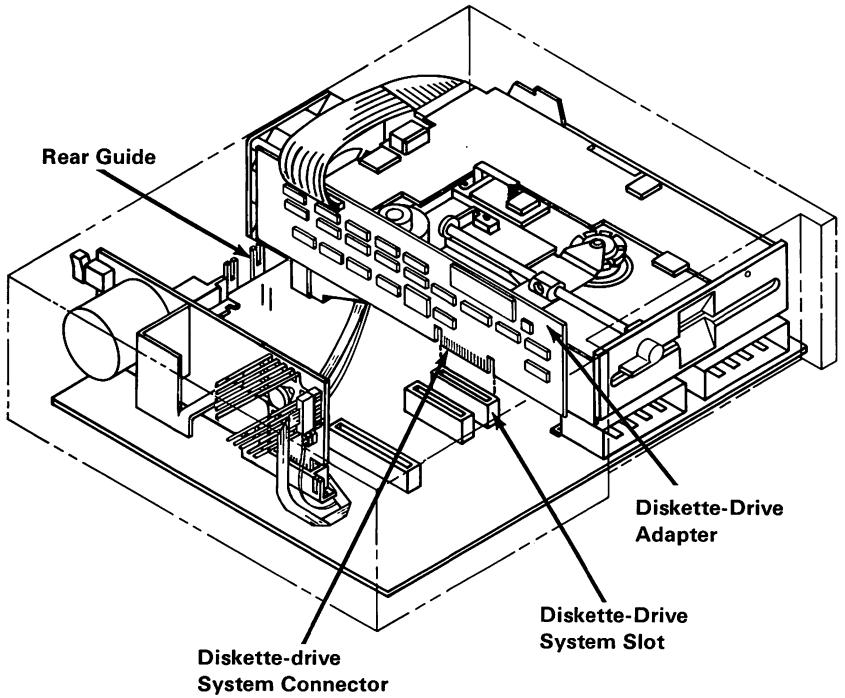

- 21** Reinstall the options removed in step 10. See Section 5 "IBM PCjr Options" if you need assistance.

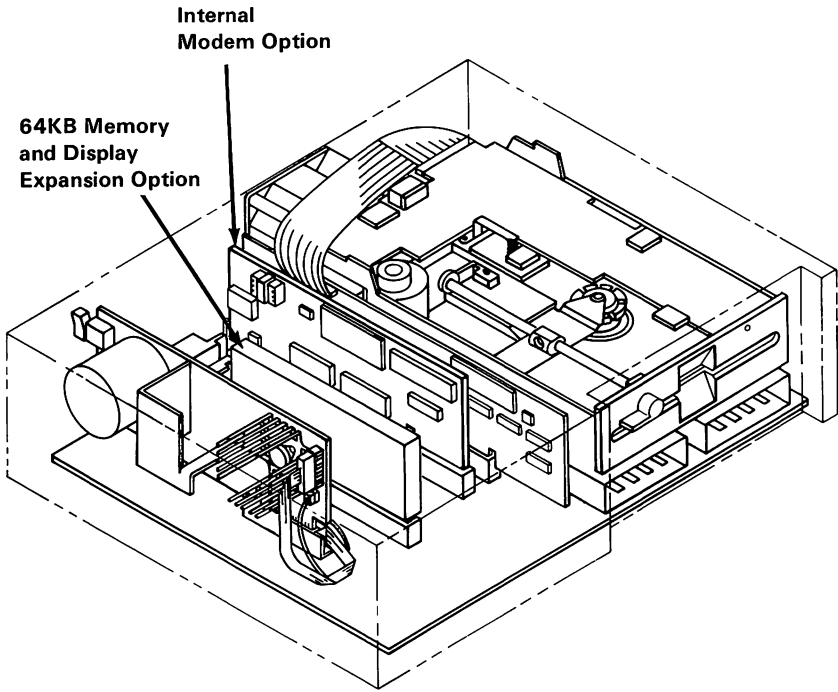

- 22** Replace the top cover by placing it on the IBM PCjr. Slide it forward until the top cover and front of the IBM PCjr fit together. Press down on the rear of the top cover until it snaps into place.

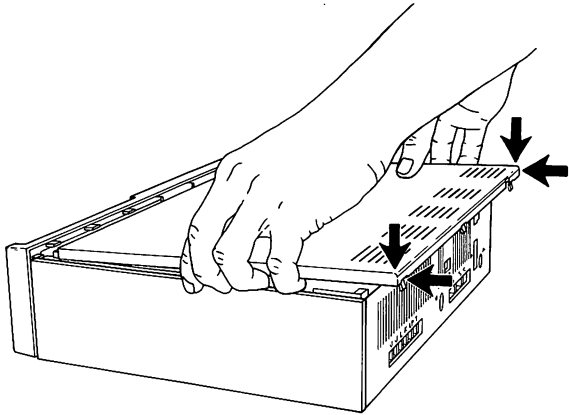

- 23** Remove the shipping protector from the diskette drive.

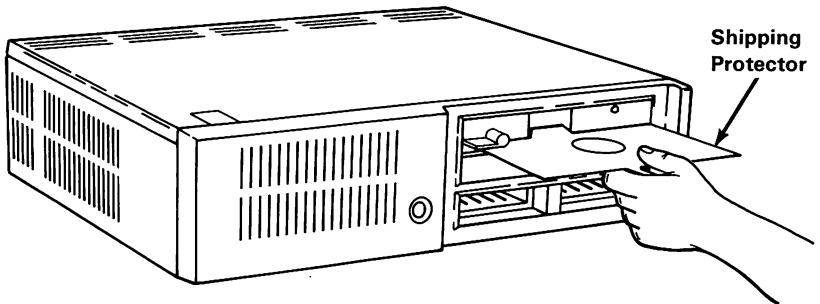

24 Plug the IBM PCjr and all option power cords into wall outlets.

25 An Exploring the IBM PCjr diskette is provided with this option. You may now run the Exploring the IBM PCjr diskette or store it in the folder in the back of the *Guide to Operations* binder. For information on how to operate your diskette drive, see the operating instructions in these option instructions.

Important:

Insert these option instructions into Section 5 of the *Guide to Operations* manual.

26 If you have any other options to install, install them at this time.

If you do not have any other options to install, continue normal operation.

Note: The operating instructions for your diskette drive are on the following pages.

Operating your Diskette Drive

This section gives you the information you need to operate your Diskette Drive.

How to Insert and Remove Diskettes

To insert a diskette:

- 1** Turn the diskette-slot handle to the open (horizontal) position.

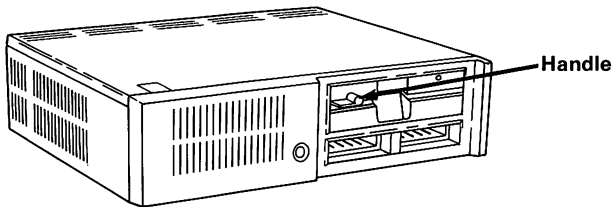

- 2** Hold your diskette with the label side up and toward you.

- 3** Gently slide the diskette all the way into the slot.

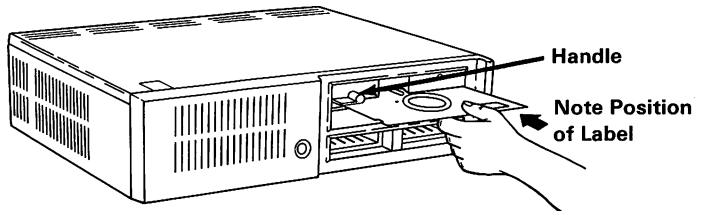

Warning: You must have a diskette in the diskette slot to put the diskette-slot handle in the closed (vertical) position.

- 4** Return the diskette-slot handle to the closed (vertical) position.

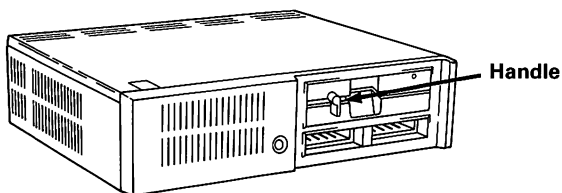

- 5** The red light on your diskette drive will light when your IBM PCjr reads or writes on a diskette. When the red light is on, do not remove the diskette from the slot.

- 6** To remove a diskette, turn the diskette-slot handle to the open (horizontal) position and slide the diskette out.

Write Protect

When a diskette is write protected, no information can be stored (written) on the diskette. To write protect a diskette, cover the notch in the side of the diskette with a write protect tab. If you want to store (write) information on a diskette, remove the write protect tab.

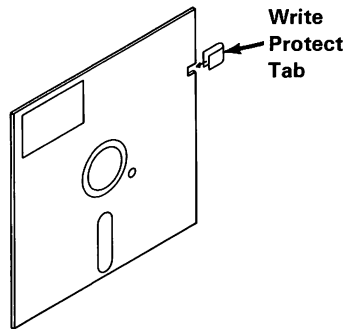

Starting a Program Diskette

With your IBM PCjr power on:

- 1 Turn the diskette-slot handle to the open (horizontal) position.
- 2 Hold your diskette with the label side up and toward you.
- 3 Gently slide the diskette all the way into the slot.

Warning: You must have a diskette in the diskette slot to put the diskette-slot handle in the closed (vertical) position.

- 4 Return the diskette-slot handle to the closed (vertical) position.
- 5 Press and hold **Ctrl** and **Alt**, then press **Del**.

With your IBM PCjr power off:

- 1 Turn the diskette-slot handle to the open (horizontal) position.
- 2 Hold your diskette with the label side up and toward you.

- 3 Gently slide the diskette all the way into the slot.

Warning: You must have a diskette in the diskette slot to put the diskette-slot handle in the closed (vertical) position.

- 4 Return the diskette-slot handle to the closed (vertical) position.

- 5 Turn your IBM PC_{jr} power on.

Notes:



Notes:



Notes:



IBM PCjr 64KB Memory and Display Expansion Installation Instructions

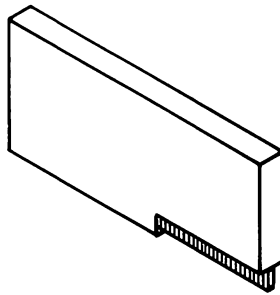
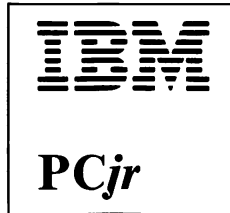

If your IBM PCjr has not been set up at this time, do so before installing this option.

If you have a diskette drive option to install, do so before installing this option.

This carton contains the following:

- IBM PCjr 64KB Memory and Display Expansion Option

If this item is missing or damaged, notify your place of purchase.



Contents

Installation Requirements	2
Tools Required	2
Installation Instructions	3

Installation Requirements

Your IBM PCjr must be set up before you can install this option.

Tools Required

- Medium-size, flat-blade screwdriver

Installation Instructions

- 1 Turn your IBM PCjr power off.
- 2 Turn all external option power off (printer, TV, cassette, etc.).
- 3 Unplug the power cords for the IBM PCjr and all options from the wall outlets.
- 4 Turn your IBM PCjr so the rear is toward you.

CAUTION

Serious shock hazards exist within the covers of the IBM PCjr. Do not open these covers unless you have unplugged your IBM PCjr power cord from the wall outlet.

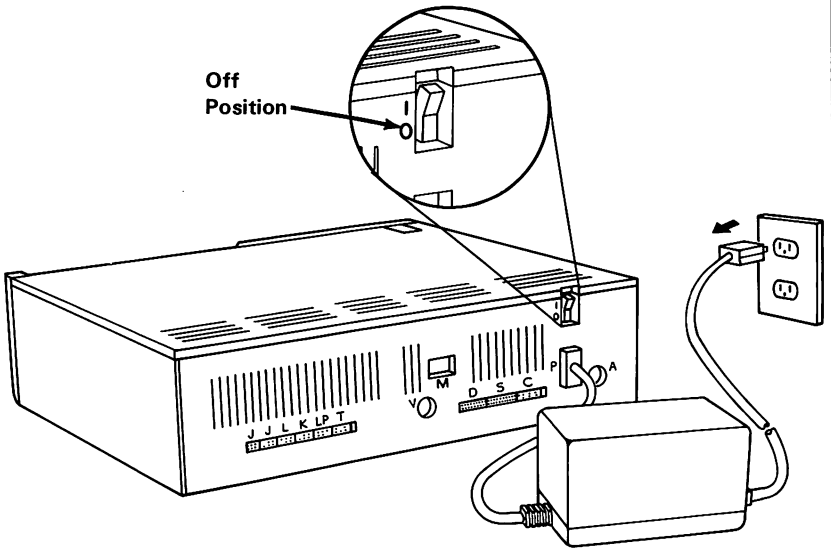

Warning: After turning your IBM PCjr power off, allow 5 minutes for cooling to take place before removing the cover.

- 5** Place a flat-blade screwdriver into the slots and twist.
- 6** Remove the top cover by lifting it up and away from the front of the IBM PCjr.

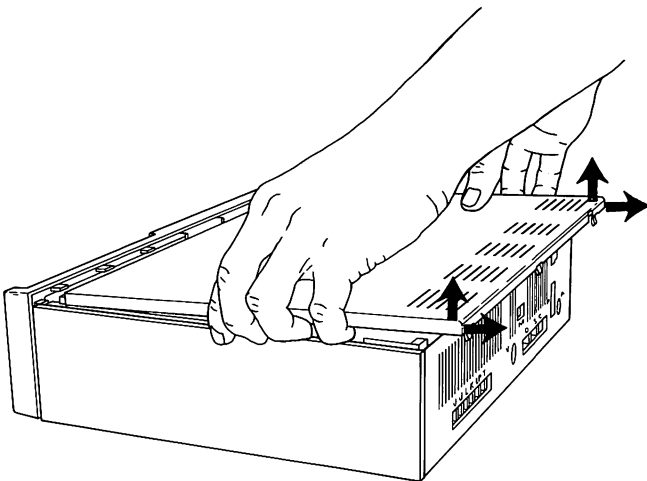
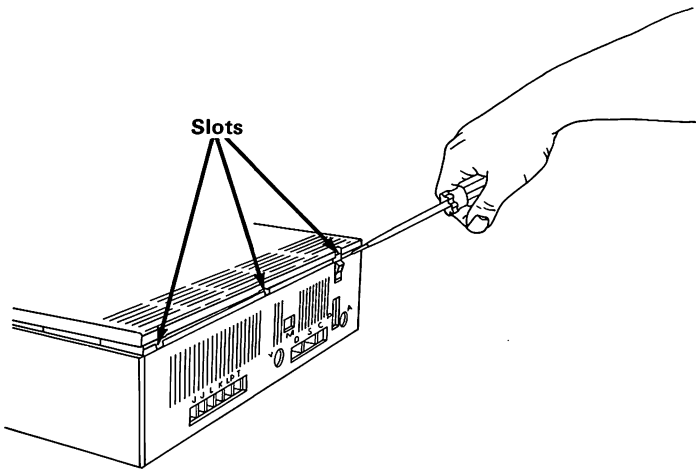

7 Turn your IBM PCjr so the front is toward you.

8 Position the 64KB Memory and Display Expansion Option so that its system connector is directly above its system slot. Press it firmly in place.

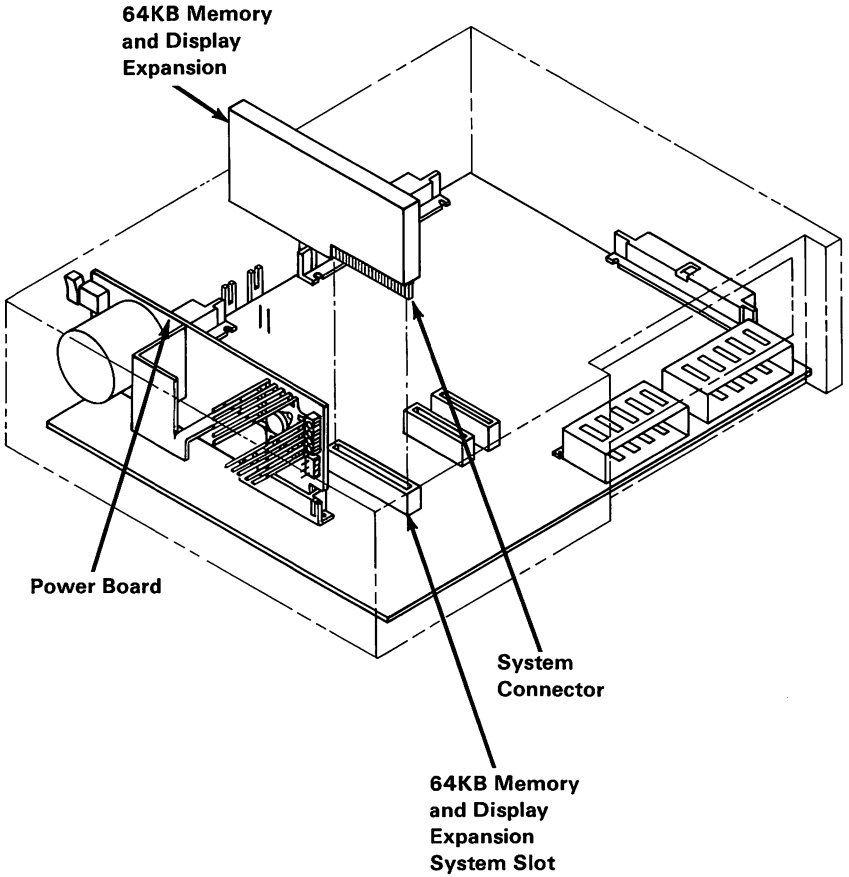

- 9** Replace the top cover by placing it on the IBM PCjr. Slide it forward until the top cover and front of the IBM PCjr fit together. Press down on the rear of the top cover until it snaps into place.

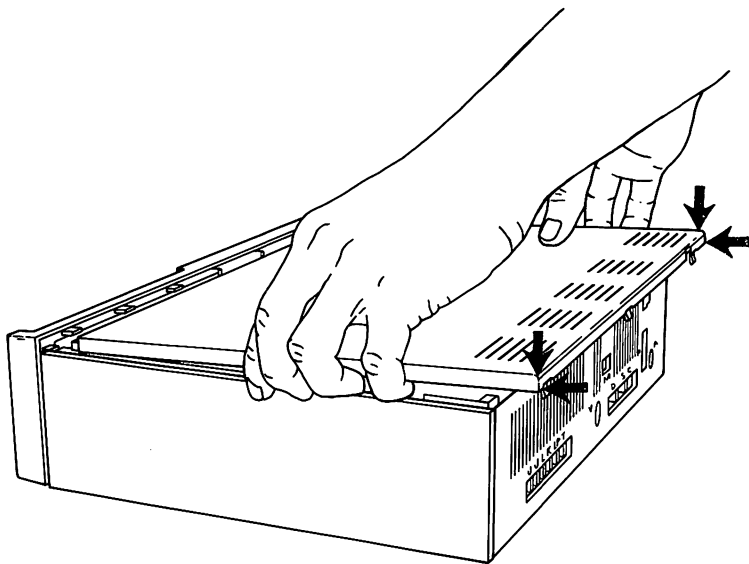

- 10** Plug the IBM PC_{jr} and all option power cords into wall outlets.

Important:

Insert these option instructions into Section 5 of the *Guide to Operations* manual.

- 11** If you have any other options to install, install them at this time.

If you do not have any other options to install, continue normal operation.

Notes:

Notes:



Notes:

SECTION 6. TESTING YOUR IBM PCjr

Contents

Introduction	6-3
First Things First	6-5
Error Message Table	6-17
Running the IBM PCjr Tests	6-21
Service Information	6-37
Test Tag 1 - Diskette Drive Test	6-39
Test Tag 4 - Television and 40-Column Display Test	6-45
Test Tag 8 - 80 Column Display Test	6-55
IBM Color Display Check Out Procedure	6-69
Test Tag 5 - Light Pen Test	6-83
Test Tag 6 - IBM PCjr Attachable Joystick Test .	6-87
Test Tag 9 - Sound Test	6-93
Test Tag J - IBM PCjr Keyboard Test	6-103
Test Tag G - IBM PCjr Internal Modem Test ..	6-111

Testing

**Test Tag A - IBM Personal Computer Graphics
Printer Test 6-115**

IBM Graphics Printer Check Out Procedure... 6-119



Introduction

This section contains a set of step-by-step instructions that help you determine if your IBM PCjr is operating properly.

You will be asked to look at, or listen to, the way your IBM PCjr responds to what you ask it to do. You will then be asked questions about what you saw or heard. Some of the colors shown in this book may be different than the colors on your screen. This is because not all televisions and displays produce the same colors. When you are asked if your screen looks like an example in this book, the important things are the shapes of the color blocks and figures and the wording of the messages.

Important

Whenever you have a suspected problem with your IBM PCjr and wish to run tests, always start with “First Things First” in this section.

Notes:

First Things First

CAUTION

Always turn your IBM PCjr power off and unplug the power cord from the wall outlet before checking any cables, or when installing options to your system.

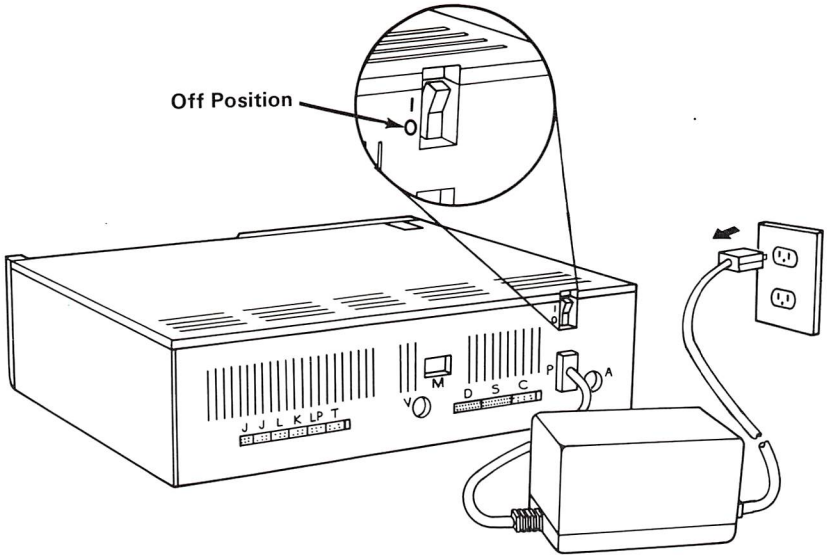

- 1 Turn your IBM PCjr power off. Go to Step 2.
- 2 Turn power off on everything attached to your IBM PCjr (printers, Television, etc.). Go to Step 3.
- 3 Unplug your IBM PCjr and your display or television power cords from the wall outlet. Go to Step 4.

4

Remove all non-IBM attachments and cables except the display or television and the IBM Connector for Television. Go to Step 5.

5

Be sure all other cables are inserted into the rear of your IBM PCjr correctly. Go to Step 6.

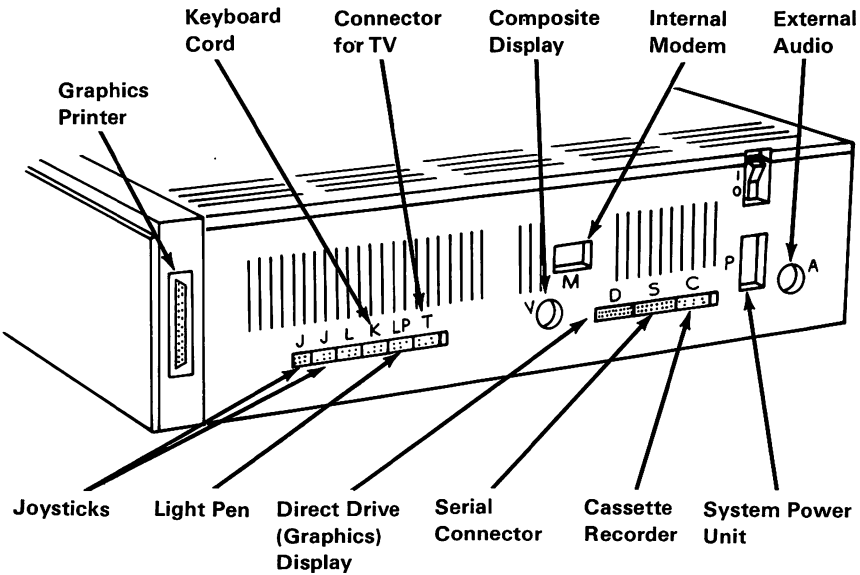

Note: Diskette errors may be caused if your display is within 15 centimeters (6 inches) of your IBM PCjr. This problem is easily cured by moving your display away from the IBM PCjr.

6

Check the wall outlet by plugging in a working lamp and switching it on. Go to Step 7.

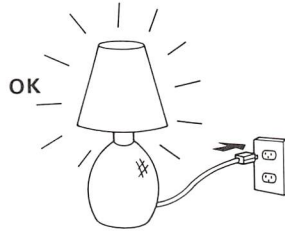

7

If you are not using a television, go to Step 9.

If you are using a television select either channel 3 or 4 (whichever one is not used in your area). Go to Step 8.

8

If you are using a television, set the Computer/Television switch on your IBM Connector for Television to "Computer" and the Channel switch to the same channel you selected for your television. If the channel you select does not seem to work well try the other. Make sure the IBM Connector for Television is connected to the VHF terminal on your television. Go to Step 9.

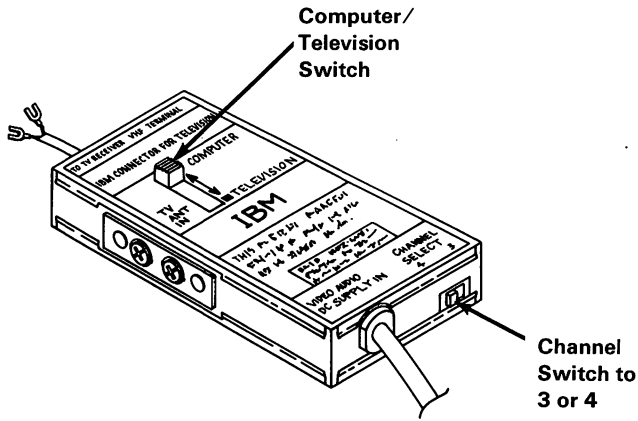

9

Plug your television or display into a working wall outlet. Turn your display or television power on. Go to Step 10.

10

If you have any cartridges or diskettes in your IBM PCjr, remove them.

Before you turn your IBM PCjr power on, let's review the three things that should happen when you do.

FIRST

The IBM Color Bar Screen with correct memory appears.

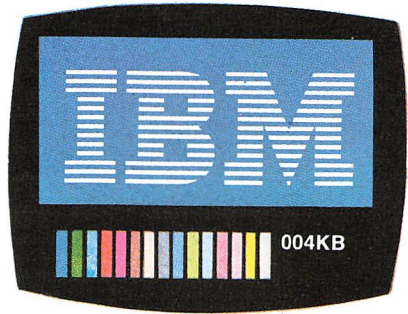

SECOND

One beep from the system unit.

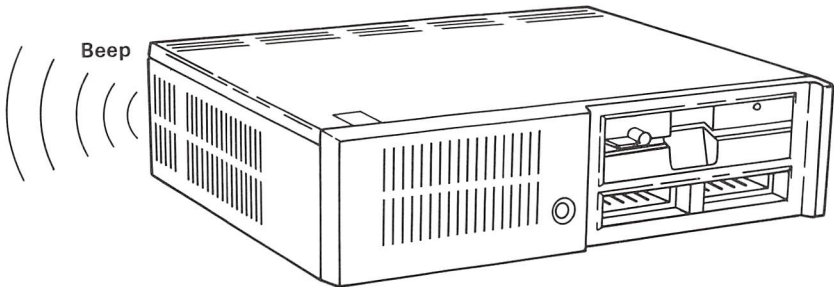

THIRD

The IBM Personal Computer BASIC Message Screen appears.

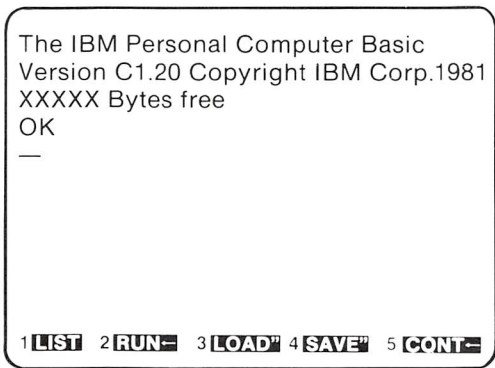

11 Plug your IBM PCjr into a working wall outlet. Go to Step 12.

12 Turn your IBM PCjr power on.

Did the three responses occur?

YES - Go to Step 13.

NO - Go to Step 21.

13 If you do not have a cartridge, go to Step 20.

If you do have a cartridge, insert it into the left cartridge slot of your IBM PCjr as shown below.

Hold your cartridge with the label side up so you can read it.

Firmly slide the cartridge into either slot until it snaps in place. If it does not snap in place make sure you have the label side up.

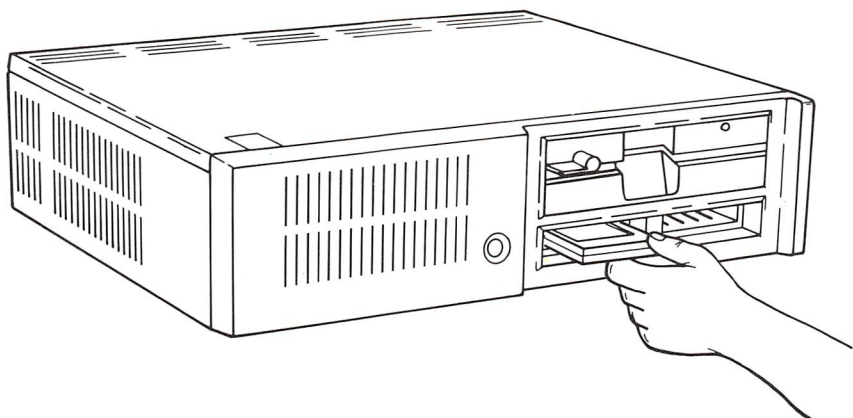

When a cartridge is inserted, your IBM PC*jr* resets as if you had just performed a reset from the keyboard. The screen clears and then the cartridge program screen appears.

After the screen clears, does the cartridge program screen appear?

YES - Remove the cartridge and go to Step 14.

NO - Remove the cartridge and go to Step 16.

14

Insert the cartridge into the right cartridge slot of your IBM PC*jr*.

After the screen clears, does the cartridge program screen appear?

YES - Go to Step 20.

NO - Go to Step 15.

- 15** Remove the cartridge and reinsert it.
- After the screen clears, does the cartridge program screen appear?
- YES -** Go to Step 20.
- NO -** Have your IBM PCjr serviced. See "Service Information" in this section.
- 16** Insert the cartridge into the right cartridge slot of your IBM PCjr.
- After the screen clears, does the cartridge program screen appear?
- YES -** Remove the cartridge and insert it into the left cartridge slot again. Go to Step 17.
- NO -** Remove the cartridge and go to Step 18.
- 17** After the screen clears, does the cartridge program screen appear?
- YES -** Go to Step 20.
- NO -** Have your IBM PCjr serviced. See "Service Information" in this section.

18 If you have another cartridge, insert it into the left cartridge slot. Go to Step 19.

If you do not have another cartridge, have your IBM PCjr serviced. See "Service Information" in this section. (Your cartridge may not be working, so keep it with your IBM PCjr.)

19 After the screen clears, does the cartridge program screen appear?

YES - The first cartridge you inserted is not working correctly and may need to be replaced. If you wish to continue with testing your IBM PCjr, Go to Step 20.

NO - Have your IBM PCjr serviced. See "Service Information" in this section.

20 If you have a cartridge in your IBM PCjr remove it. Go to "Running the IBM PCjr Tests" in this section.

21

You are here because you did not receive the three correct responses when you turned your IBM PCjr power on.

Did the IBM Color Bar screen appear?

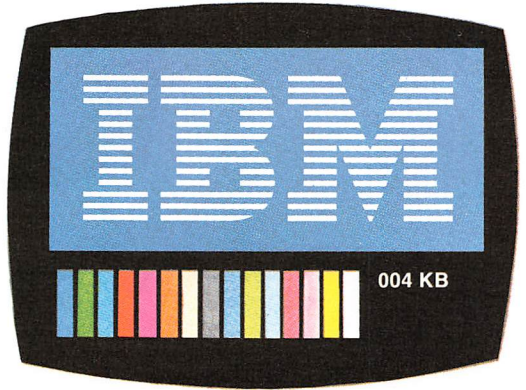

YES - Go to Step 22.

NO - Go to Step 24.

22

Did the letters IBM appear correctly in the box at the top of the screen?

YES - Go to Step 23.

NO - Have your IBM PCjr serviced. See "Service Information" in this section.

23

Does the word "ERROR" and a letter appear in the lower right-hand corner of your screen?

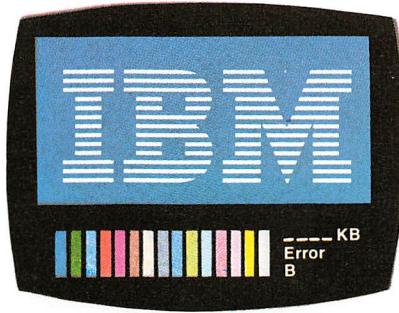

YES - Follow the instructions found in the Error Message Table starting on the next page.

NO - Go to Step 24.

Error Message Table

ERROR

ACTION

A Have your IBM PCjr serviced.
D See "Service Information"
G in this section.
X

B

Keyboard Problem

This error may be caused by extremely bright light (such as direct sunlight or bright fluorescent light). Move your IBM PCjr away from the bright light and turn the power on. If you still get this error have your IBM PCjr serviced. See "Service Information" in this section.

C

Cassette Problem

If you want to use your IBM PCjr without using your cassette

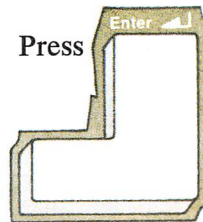

If you want to use a cassette recorder, have your IBM PCjr serviced. See "Service Information" in this section.

E

Modem Problem

If you want to use your IBM PC_{jr} without using your modem

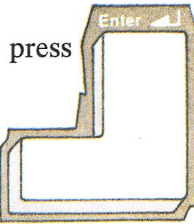

If you want to use a modem, have your IBM PC_{jr} serviced. See "Service Information" in this section.

H

Diskette Problem

If you want to use your IBM PC_{jr} without using the diskette drive,

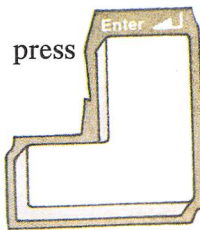

If you want to use the diskette drive, have your IBM PC_{jr} serviced. See "Service Information" in this section.

24

Did you hear any beeps?

YES - Go to Step 25.

NO - Have your IBM PCjr serviced. See "Service Information" in this section.

25

Did you hear just one beep?

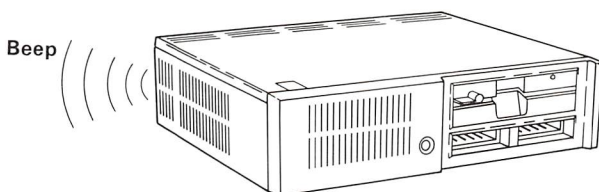

YES - Go to Step 26.

NO - Have your IBM PCjr serviced. See "Service Information" in this section.

26

If you have a television, go to Step 27.

If you have an IBM Personal Computer Color Display, go to "IBM Color Display Check Out Procedure" in this section.

If you have a display other than an IBM Personal Computer Color Display, have your IBM PCjr and the display serviced. See "Service Information" in this section.

- 27** Turn your television power off. Go to Step 28.
- 28** Disconnect your IBM Connector for Television from the rear of your IBM PCjr. Go to Step 29.
- 29** Set the Computer/Television switch on the IBM Connector for Television to "Television" Go to Step 30.
- 30** Set your television channel to a local station. Go to Step 31.
- 31** Turn your television power on.
- Does your television work?
- YES -** Have your IBM Connector for Television and your IBM PCjr serviced. See "Service Information" in this section.
- NO -** Connect your IBM PCjr to a working Television.

Running the IBM PCjr Tests

You have been directed here from "First Things First". At this point some of the basic IBM PCjr hardware has been tested. You are now ready to test the rest of your IBM PCjr system.

- 1 Turn your IBM PCjr power off.
- 2 Turn your IBM PCjr power on. After the IBM Color Bar screen appears, the IBM Personal Computer BASIC message screen appears.



```
The IBM Personal Computer Basic
Version C1.20 Copyright IBM Corp.1981
XXXXX Bytes free
OK
—
```



```
1 TEST 2 RUN 3 LOAD 4 SAVE 5 ON
```

Important: The next screen that appears will appear only briefly, so you need to know what to look for before we continue. The screen that will appear is called the IBM Color Bar screen. When it does appear, your IBM PCjr begins to test itself. While this test takes place, the amount of memory being tested appears in the lower right-hand corner. It will start with 4KB and end with either 64KB or 128KB, depending on the amount of memory installed. Make a note of the final memory message when it appears. Go to Step 3.

3

To start running the tests, press and hold

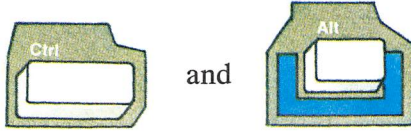

Release all three keys.

Does the IBM Color Bar screen appear?

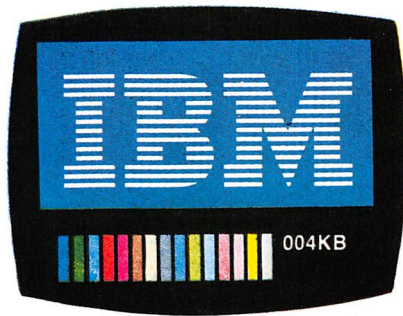

YES - Go to Step 6.

NO - Go to Step 4.

Are you using the IBM PCjr Keyboard Cord to connect your IBM PCjr Keyboard to your IBM PCjr?

YES - Check the Connectors on the IBM PCjr Keyboard Cord to be sure that they are not bent or broken, also make sure that the connectors are pushed all the way into the IBM PCjr, and keyboard. Go to Step 5.

NO - Check your IBM PCjr Keyboard to be sure that the batteries are good, and that the Keyboard is positioned within 6.1 meters (20 feet) of your IBM PCjr. Make sure nothing is blocking the beam between the keyboard and the front of the IBM PCjr. Go to Step 5.

5

Try again to start running tests, press and hold

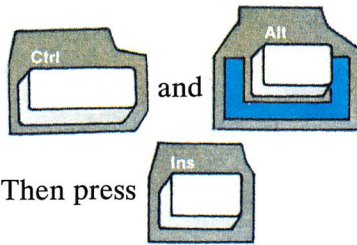

Release all three keys.

Does the IBM Color Bar screen appear?

YES - Go to Step 6.

NO - Have your IBM PCjr serviced. See "Service Information" in this section.

- 6** Did the memory message end with 64KB?
- YES -** Go to Step 7.
- NO -** Go to Step 8.
- 7** Do you have the 64KB memory and display expansion option installed?
- YES -** Have your IBM PC_{jr} serviced. See "Service Information" in this section.
- NO -** Go to Step 10.
- 8** Did the memory message end with 128KB?
- YES -** Go to Step 9.
- NO -** Have your IBM PC_{jr} serviced. See "Service Information" in this section.
- 9** Do you have the 64KB memory and display expansion option installed?
- YES -** Go to Step 10.
- NO -** Have your IBM PC_{jr} serviced. See "Service Information" in this section.

After the IBM Color Bar screen displays the amount of memory installed, the first of two IBM PCjr Test Menu Screens appears.

The First IBM PCjr Test Menu Screen looks like this:

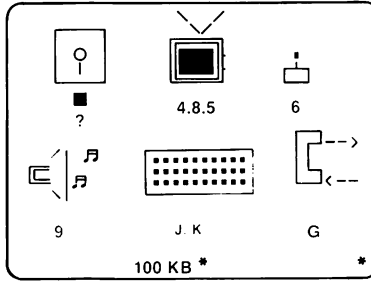

The Second IBM PCjr Test Menu Screen looks like this:

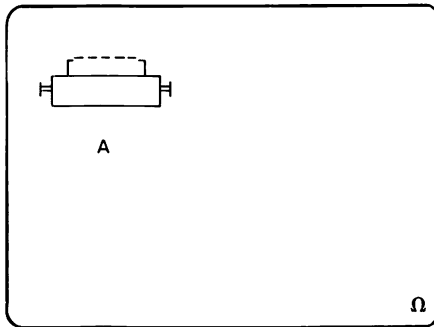

Notice that there is a character under each figure. These characters are called Test Tags. Test Tags are used to select the individual test you wish to run.

When the First IBM PCjr Test Menu Screen appears the blinking cursor is located on Test Tag 1.

You may move the cursor to any of the Test Tags by pressing the Ins key until the cursor is positioned on the Test Tag you wish to use.

When you have moved the cursor to Test Tag G on the First IBM PCjr Test Menu Screen and press the Ins key, the Second IBM PCjr Test Menu Screen appears. The cursor will be on Test Tag A.

To return to the First IBM PCjr Test Menu Screen, press the Ins key. The First IBM PCjr Test Menu Screen appears and the cursor is on Test Tag 1.

To start any test:

- Position the cursor on the Test Tag you want.
- Press the Enter key.
- Go to the documentation in this section that describes the test you have chosen to run.

Note: If you are going to run the Modem Test, disconnect your modem from the telephone jack, before pressing enter.

Note: If you are going to run the Sound Test, read the first page of "Test Tag 9 - Sound Test" in this Section, before pressing enter.

For example:

- Move the cursor to Test Tag G.
- Before Pressing Enter, disconnect your modem from your telephone jack.
- Press the Enter key.
- Go to "Test Tag G - IBM PCjr Internal Modem Test" found in this section.

FIRST IBM PCjr TEST MENU SCREEN

Test Tag	Name
1	Diskette Drive Test
4	TV and 40 Column Display Test
8	80 Column Display Test
5	Light Pen Test
6	Attachable Joystick Test
9	Sound Test
J	Keyboard Test
K	Reserved for future use
G	Modem Test

SECOND IBM PCjr TEST MENU SCREEN

Test Tag	Name
A	Graphics Printer Test

BLINKING TEST TAGS

The following Test Tags should always be blinking:

4,5,6,9 and J.

If any of them are not blinking, have your IBM PCjr serviced. See "Service Information" in this section.

The following is a list of the options that can be added to your IBM PCjr. If the option is installed, the Test Tag will be blinking. If the option is not installed, the Test Tag will not be blinking.

TAG	WILL BE PRESENT AND BLINK WHEN
------------	---------------------------------------

1	A diskette drive is installed in your IBM PCjr.
----------	---

8	A 64KB Memory and Display Expansion Adapter is installed in your IBM PCjr.
----------	--

A	A Parallel Printer Attachment is attached to your IBM PCjr.
----------	---

G	An IBM PCjr Internal Modem is installed in your IBM PCjr.
----------	---

Go to Step 11.

11

Are all of the Test Tags present and blinking for the options you have installed?

YES - Go to Step 17.

NO - Go to Step 12.

12

Select the item that is not blinking and follow the instructions in the table below.

Number	Tests	Action
1	Diskette Drive	Go to Step 13.
4 J 5 6 9	TV and 40 Column Display Keyboard Light Pen Attachable Joystick Sound	Have your PCjr serviced. See "Service Information" in this section.
8	80 Column Display	Go to Step 14.
A	Parallel Printer	Go to Step 15.
G	Modem	Go to Step 16.

13

Is your diskette drive installed?

YES - Have your IBM PCjr serviced. See "Service Information" in this section.

NO - The diskette drive must be installed for Test Tag 1 to blink. Go to Step 11.

14

Do you have the 64KB Memory and Display Expansion option installed in your IBM PCjr?

YES - Have your IBM PCjr serviced. See "Service Information" in this section.

NO - The 64KB Memory and Display Expansion option must be installed for Test Tag 8 to blink. Go to Step 11.

15

Is your Parallel Printer Attachment installed?

YES - Have your IBM PCjr serviced. See "Service Information" in this section.

NO - The Parallel Printer Attachment must be installed for Test Tag A to blink. Go to Step 11.

16

Is your IBM PCjr Internal Modem installed?

YES - Have your IBM PCjr serviced. See "Service Information" in this section.

NO - The IBM PCjr Internal Modem must be installed for Test Tag G to blink. Go to Step 11.

17 Is any Test Tag blinking which should not be?

YES - Have your IBM PCjr serviced. See "Service Information" in this section.

NO - Go to Step 18.

18 Move the cursor to the Test Tag for the test you want to run. Press the Enter key. Go to the documentation in this Section that describes the test you have chosen to run.

Notes:



Service Information

If part of your IBM PCjr has a problem and must be serviced, do the following:

- 1** Turn your IBM PCjr and all attachments power off.
- 2** Unplug your IBM PCjr power cord from the wall outlet.
- 3** Have the failing unit serviced. If you have been directed to have your IBM PCjr serviced, don't forget that the power cord, keyboard, and all side attached options are considered part of the IBM PCjr, so you need to keep them with the system unit. You should keep any cartridges or diskettes with the IBM PCjr that were being used when the failure occurred.
- 4** Bring the failing unit to your place of purchase for service. Call your place of purchase for specific instructions before bringing in your failing unit.

Notes:

Test Tag 1 - Diskette Drive Test

You must have a diskette drive installed to run this test.

The screen will show a diskette being inserted into your IBM PC_{jr} and coming out with the information erased.

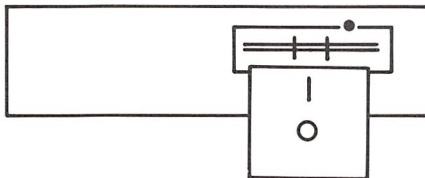
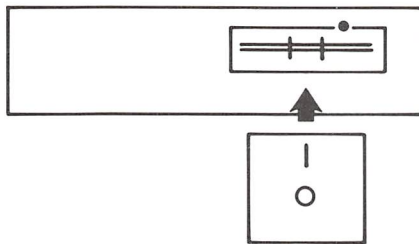

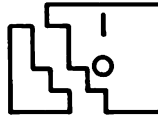
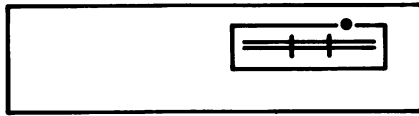
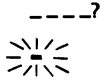
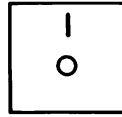
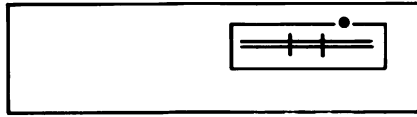

A **BLANK** diskette must be used to run the diskette-drive test. If a diskette with information on it is used for the diskette-drive test, the information will be erased.

If you decide to discontinue running the diskette-drive test and return to the First IBM PCjr Test Menu Screen, press Fn and then press Break.

- 1 After the screen showing an erased diskette appears, insert a blank diskette in your diskette drive.
- 2 Type the letters MPNP. These letters will appear in the upper left-hand corner of the screen. This tells your IBM PCjr that you have inserted a blank diskette. (If you type the wrong letters, your IBM PCjr will beep once and wait for you to type the correct letters.)

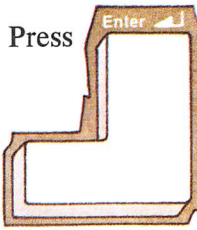

Your IBM PCjr performs a test on your diskette drive. When it is finished, the First IBM PCjr Test Menu Screen appears again. Test Tag "1", has a message underneath it. The meaning of this message is shown below:

- * Your diskette drive is working properly.
- A You do not have a diskette-drive adapter installed. If you do have a diskette-drive adapter installed, have your IBM PCjr serviced. See "Service Information" in this section.
- B Have your IBM PCjr serviced. See "Service Information" in this section.

- C** The diskette in your diskette drive is "write protected". The diskette-drive test cannot be done with a "write protected" diskette. If you need to review what write protected means, see "IBM PC_{jr} Diskette Drive Option Instructions" in Section 5. Remove the diskette and insert a blank one, then run the diskette-drive test again. If your diskette is not "write-protected" but the diskette-drive test results in a "C" code, have your IBM PC_{jr} serviced. See "Service Information" in this section.
- D** A diskette has not been inserted or the diskette slot handle is not in the closed position. If you need to review how to insert a diskette, see "IBM PC_{jr} Diskette Drive Option Instructions" in Section 5. When you have closed the diskette slot handle, repeat the diskette-drive test. If the diskette-drive test results in a "D" code, have your IBM PC_{jr} serviced. See "Service Information" in this section.

? You have interrupted the diskette-drive test before it was completed by pressing **Fn** and then pressing **Break**. If you wish to complete the diskette-drive test, return to "Running Your IBM PC*jr* Tests." in this section.

4 Remove the blank diskette from your diskette drive.

5 Do you want to run another test?

YES - Go to the "Running Your IBM PC*jr* Tests" in this section.

NO - You may run the "Exploring the IBM PC*jr*" diskette at this time. If you have run the "Exploring the IBM PC*jr*" diskette you may continue normal operations.

Test Tag 4 - Television and 40-Column Display Test

Note: This test applies to color and black and white televisions and displays. Remember, because colors on televisions and display screens vary, the colors in this book may not match the colors on your screen.

If, while running the Television and 40-Column Display Test, you wish to discontinue the test and return to the First IBM PCjr Test Menu Screen, press Fn, then press Break.

1

Do the shapes of the blocks and figures on your screen match those in the example below?

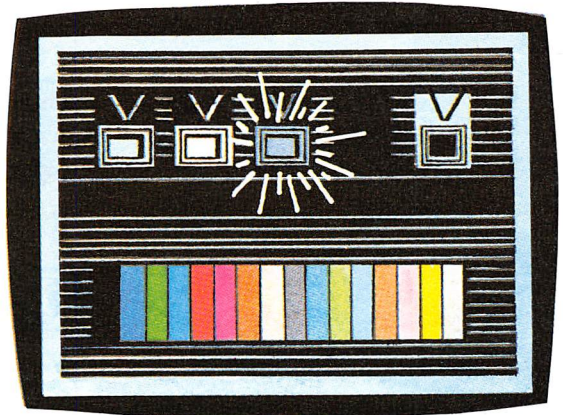

YES - Press

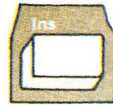

and go to Step 2.

NO - Have your IBM PCjr serviced. See "Service Information" in this section.

Does your screen match the figure below?

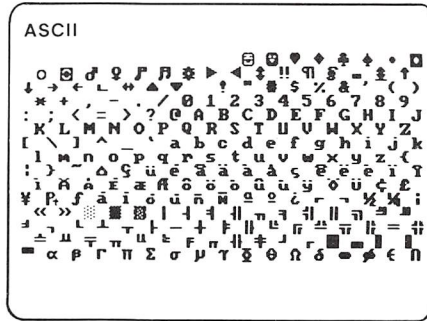

YES - Press

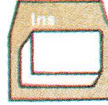

and go to Step 3.

NO - Have your IBM PCjr serviced. See "Service Information" in this section.

Does your screen match the figure below?

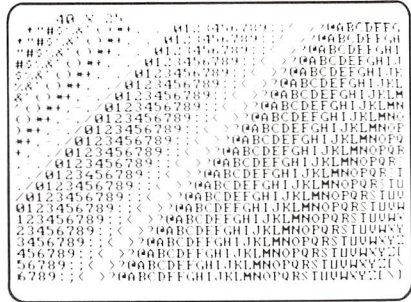

YES - Press

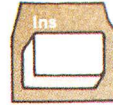

and go to Step 4.

NO - Have your IBM PCjr serviced. See "Service Information" in this section.

4

Do the shapes of the blocks and figures on your screen match those in the example below?



YES - Press

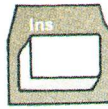

and go to Step 5.

NO - Have your IBM PCjr serviced. See "Service Information" in this section.

5

Do the shapes of the blocks and figures on your screen match those in the example below?

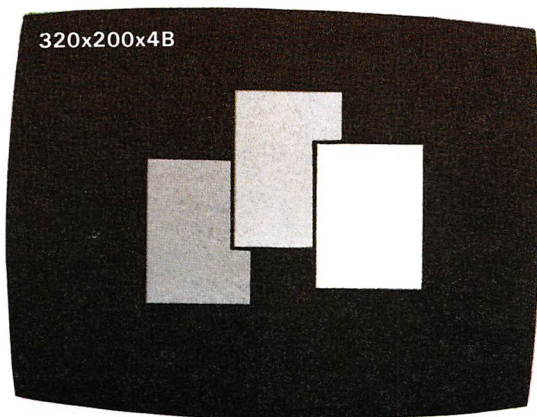

YES - Press

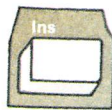

and go to Step 6.

NO - Have your IBM PCjr serviced. See "Service Information" in this section.

6

Do the shapes of the blocks and figures on your screen match those in the example below?

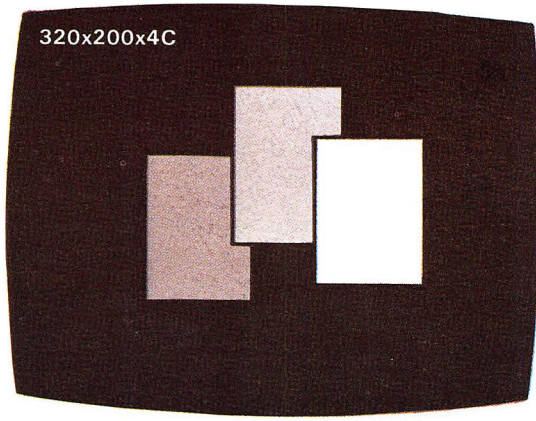

YES - Press

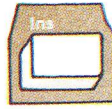

and go to Step 7.

NO - Have your IBM PCjr serviced. See "Service Information" in this section.

Your screen should be filled with zeros (0's).

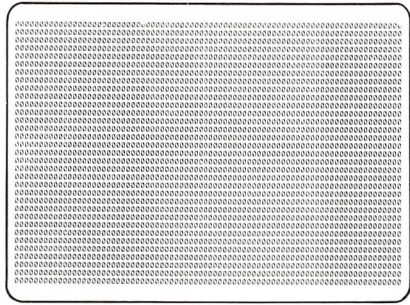

Press

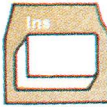

Another screen appears. Continue to press the Insert key, each time displaying the next screen, until you reach a screen filled with sevens (7).

Did you reach the screen filled with sevens?

YES - Press

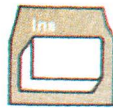

and go to Step 8.

NO - Have your IBM PC_{jr} serviced. See "Service Information" in this section.

Some blank screens appear briefly and then the First IBM PCjr Test Menu Screen appears. A message appears under Test Tag "4". The meaning of these messages are shown below:

- * You have completed the Television and 40 Column Display Test. Go to Step 9.

- B** Have your IBM PCjr serviced. See "Service Information" in this section.

- ? You have interrupted the Television and 40 Column Display test before it was completed by pressing Fn and then pressing Break. If you wish to complete the test, return to "Running the IBM PCjr Tests" in this section and select the test again.

Do you want to run another test?

YES - Go to the "Running the IBM PC_{jr} Tests" in this section.

NO - If you have a diskette drive installed, you may run the "Exploring the IBM PC_{jr}" diskette at this time. If you have run the "Exploring the IBM PC_{jr}" diskette you may continue normal operations.

Notes:



Test Tag 8 - 80 Column Display Test

Note: This test applies to color and non-color displays. Remember, because colors vary, the colors in this book may not match the colors on your screen.

If, while running the 80CD TEST, you wish to discontinue the test and return to the First IBM PCjr Test Menu Screen, press Fn, then press Break.

- 1 Do the shapes of the blocks and figures on your screen match those in the example below?

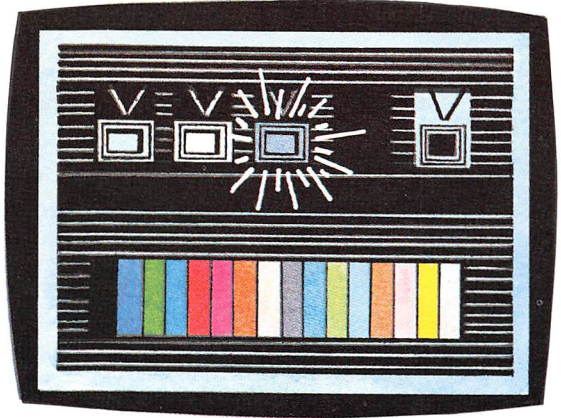

YES - Press 

and go to Step 2.

NO - Have your IBM PCjr serviced. See "Service Information" in this section.

Does your screen match the example below?

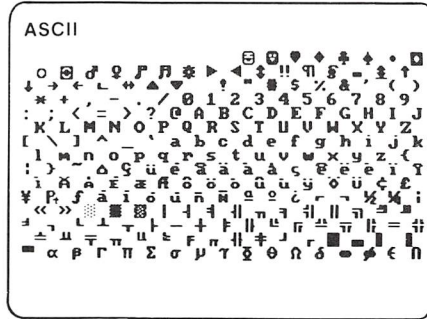

YES - Press

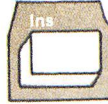

and go to Step 3.

NO - Have your IBM PCjr serviced. See "Service Information" in this section.

Does your screen match the example below?

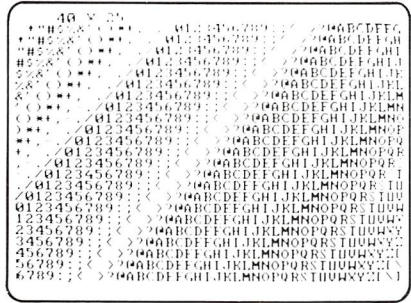

YES - Press

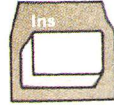

and go to Step 4.

NO - Have your IBM PCjr serviced. See "Service Information" in this section.

4

Do the shapes of the blocks and figures on the screen match those in the example below?

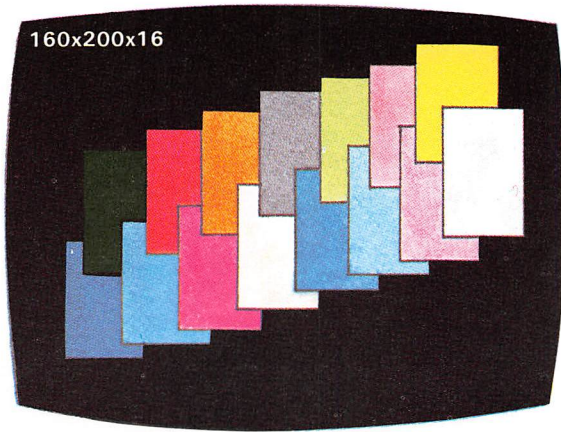

YES - Press 

and go to Step 5.

NO - Have your IBM PCjr serviced. See "Service Information" in this section.

5

Do the shapes of the blocks and figures on the screen match the example below?

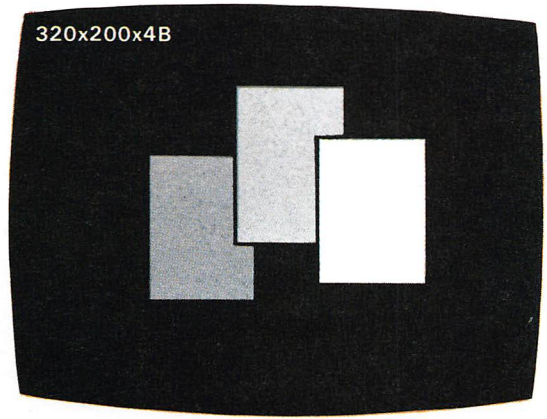

YES - Press

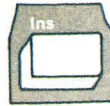

and go to Step 6.

NO - Have your IBM PCjr serviced. See "Service Information" in this section.

6

Do the shapes of the blocks and figures on the screen match the example below?

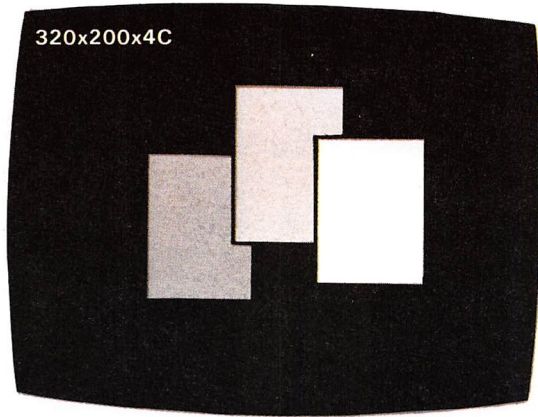

YES - Press

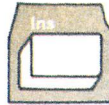

and go to Step 7.

NO - Have your IBM PCjr serviced. See "Service Information" in this section.

7

Do the shapes of the blocks and figures on the screen match the example below?

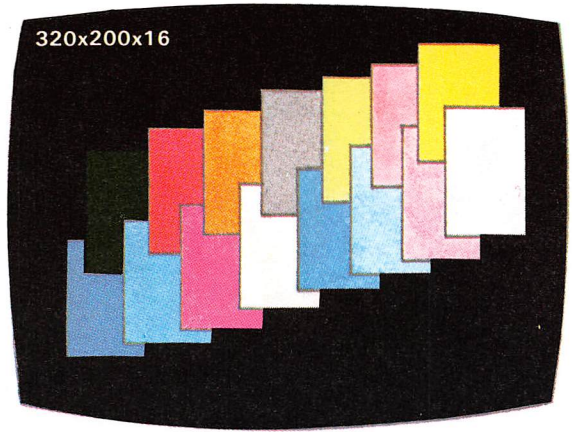

YES - Press

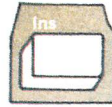

and go to Step 8.

NO - Have your IBM PCjr serviced. See "Service Information" in this section.

Does your screen match the figure below?

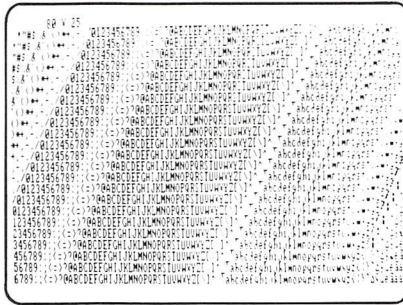

YES - Press

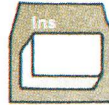

and go to Step 9.

NO - Have your IBM PCjr serviced. See "Service Information" in this section.

9

Do the shapes of the blocks and figures on the screen match the example below?

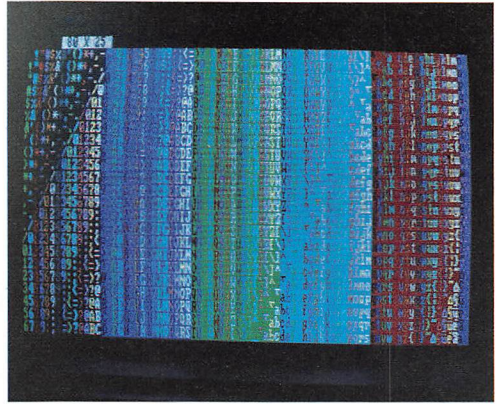

YES - Press

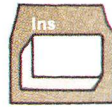

and go to Step 10.

NO - Have your IBM PCjr serviced. See "Service Information" in this section.

10

Do the shapes of the blocks and figures on the screen match the example below?

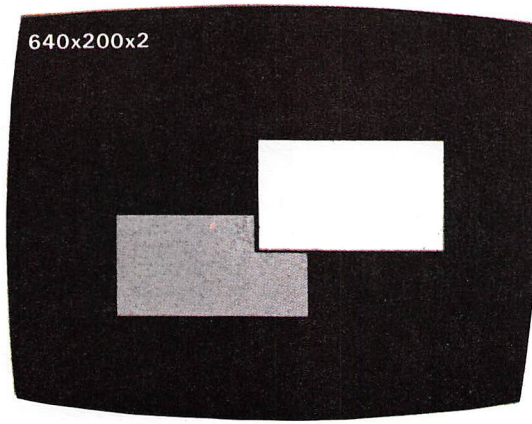

YES - Press

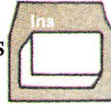

and go to Step 11.

NO - Have your IBM PCjr serviced. See "Service Information" in this section.

11

Do the shapes of the blocks and figures on the screen match the example below?

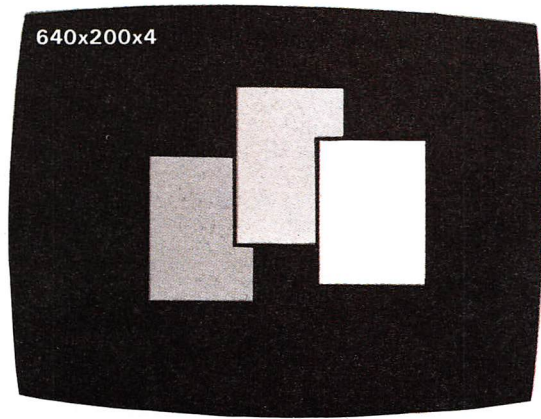

YES - Press

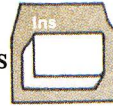

and go to Step 12.

NO - Have your IBM PCjr serviced. See "Service Information" in this section.

Your screen is filled with zeros (0).

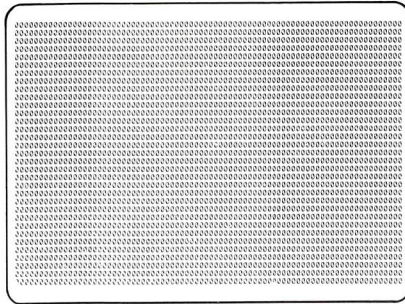

Press

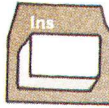

Another screen appears. Continue to press the Insert key, each time displaying the next screen, until the screen is filled with sevens (7).

Did you reach the screen filled with sevens?

YES - Press

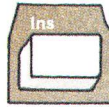

and go to Step 13.

NO - Have your IBM PCjr serviced. See "Service Information" in this section.

Some blank screens appear briefly and then the First IBM PCjr Test Menu Screen appears. A message appears under the Test Tag "8". The meaning of the message is shown below:

- * You have completed the 80CD TEST. Go to Step 14.
- A You do not have enough memory installed to run the 80CD TEST. This test requires the 64KB memory and display expansion option installed in your IBM PCjr. If you have the 64KB memory and display expansion option installed, have your IBM PCjr serviced. See "Service Information" in this section. If you do not have the 64KB memory and display expansion option installed go to Step 14.
- B Have your IBM PCjr serviced. See "Service Information" in this section.
- ? You have interrupted the 80CD TEST before it was complete by pressing Fn and then pressing Break. Go to Step 14.

Do you want to run another test?

- YES -** Go to the "Running the IBM PCjr Tests" in this section.
- NO** If you have a diskette drive installed, you may run the "Exploring the IBM PCjr" diskette at this time. If you have run the "Exploring the IBM PCjr" diskette before, you may continue normal operations.

IBM Color Display Check Out Procedure

If your IBM Color Display needs to be serviced, it must be returned with the power cord.

- 1 Turn your IBM Color Display power on.

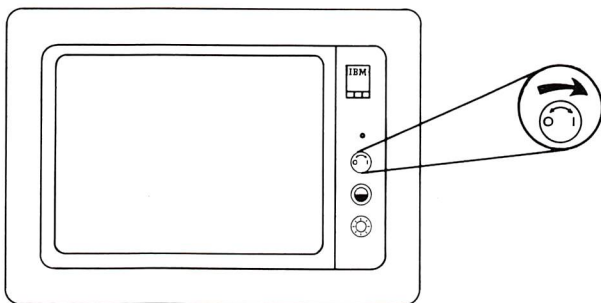

- 2 Is the Power-On indicator lit?

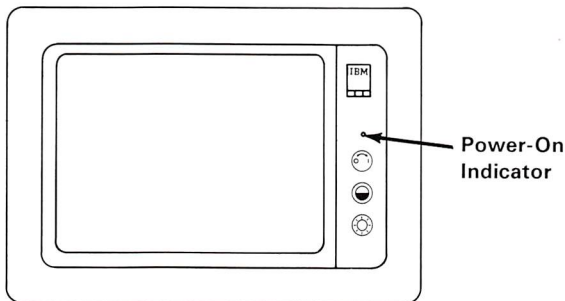

YES - Go to Step 3.

NO - See if the power cord is plugged into a working wall outlet and into the rear of the display. If it is, have your IBM Color Display serviced. See "Service Information" in this section.

- 3 Turn your IBM PCjr power off.
- 4 Turn the Brightness and Contrast controls fully clockwise.

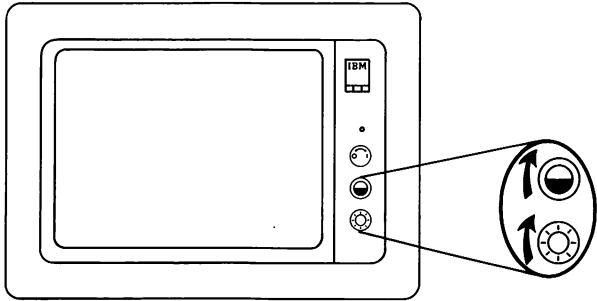

- 5 Turn the Vertical Size control knob fully counterclockwise. A black area should appear across the top and the bottom of the screen.

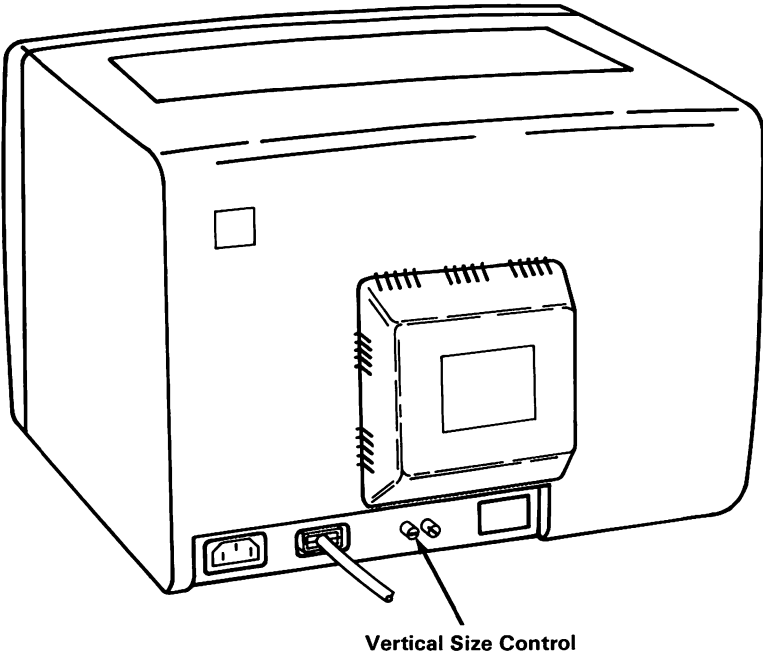

6

Does a black area appear across the top and the bottom of the screen?

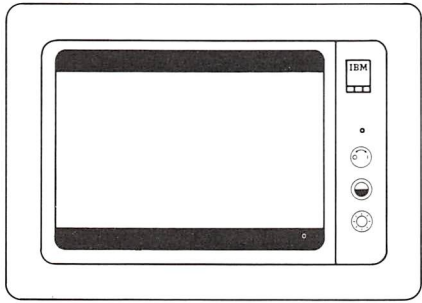

YES - Go to Step 7.

NO - Have your IBM Color Display serviced. See "Service Information" in this section.

7

Are the black areas at the top and bottom of the screen about the same size?

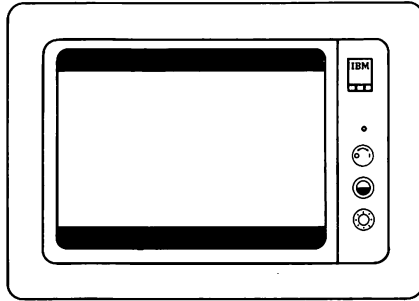

YES - Go to Step 8.

NO - Have your IBM Color Display serviced. See "Service Information" in this section.

8

Turn the Vertical Size control clockwise until the black areas at the top and bottom of the screen just disappear. If one of the black areas disappears before the other, continue to turn the control until the second black area is gone. Go to Step 9.

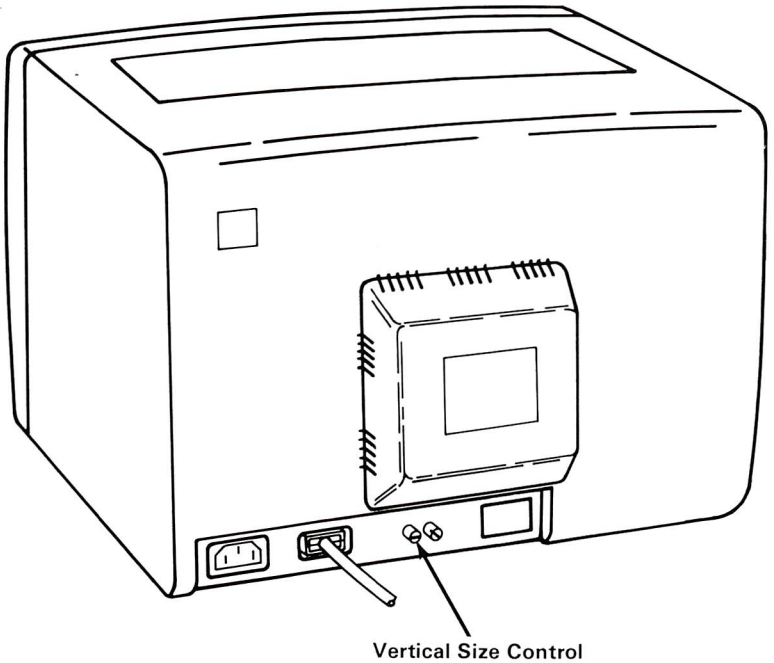

9

Is the screen light blue?

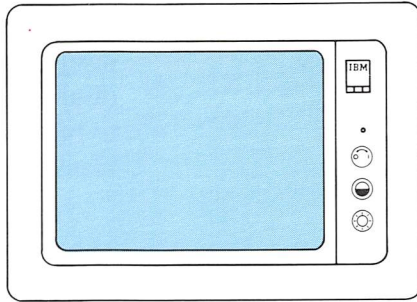

YES - Go to Step 15.

NO - Go to Step 10.

10

Turn your IBM Color Display power off. Go to Step 11.

11

Turn your IBM PCjr power off. Go to Step 12.

12

Disconnect the IBM Color Display's signal cable from the rear of your IBM PCjr.

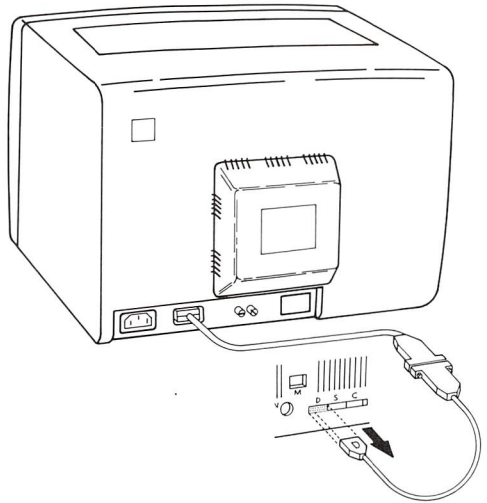

13

Turn your IBM Color Display power on. Go to step 14.

14

Is the screen light blue?

YES - Have your IBM PCjr serviced. See "Service Information" in this section.

NO - Have your IBM Color Display serviced. See "Service Information" in this section.

15 While watching the screen, turn your IBM PCjr power off, wait 5 seconds then turn your IBM PCjr power on.

16 Did the screen change from light blue to black as soon as you turned your IBM PCjr power on? (This totally black condition may last only a few seconds. After it does, the IBM Color Bar screen appears again, followed by the IBM Personal Computer BASIC Message Screen).

YES - Go to Step 17.

NO - Have your IBM Color Display serviced. See "Service Information" in this section.

17 Wait for your IBM PCjr to finish testing itself. The IBM Personal Computer BASIC Message Screen will appear with a blinking cursor. Go to Step 18.

18 Did the IBM Personal Computer BASIC Message Screen appear?

YES - Go to Step 19.

NO - Have your IBM PCjr serviced. See "Service Information" in this section.

19

Is the screen stable?

YES - Go to Step 22.

NO - Go to Step 20.

20

Turn the Vertical Hold Control clockwise as far as it will go. Then, turn it counterclockwise until the screen stops rolling and is stable. Go to step 21.

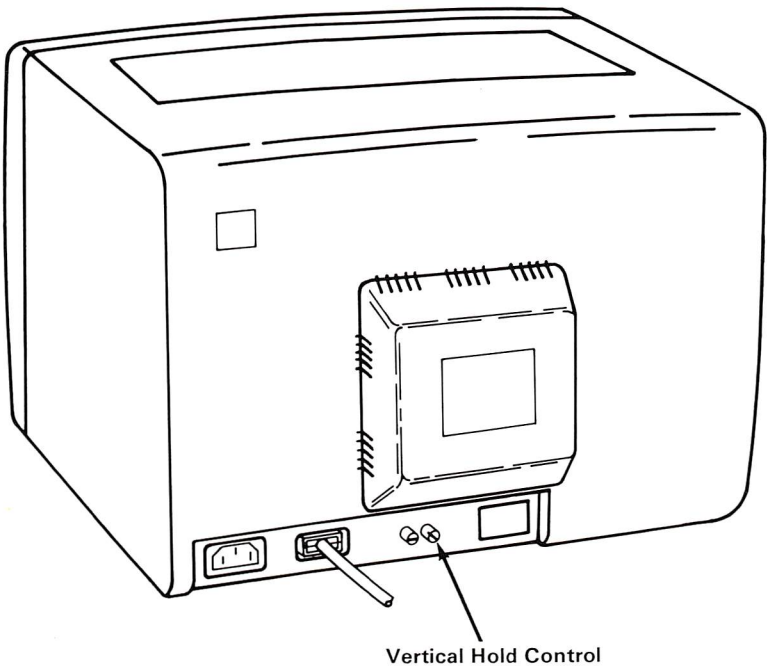

- 21** Were you able to make the screen stable?
- YES -** Go to Step 22.
- NO -** Have your IBM Color Display serviced. See "Service Information" in this section.
- 22** Does the screen have white characters on a dark background?
- YES -** Go to Step 28.
- NO -** Go to Step 23.
- 23** Turn your IBM PCjr power off.
- 24** Turn your IBM Color Display power off.
- 25** Disconnect the IBM Color Display's signal cable from the adapter on the rear of your IBM PCjr.
- 26** Turn your IBM Color Display power on.

27

Is the screen light blue?

YES - Have your IBM PCjr serviced. See "Service Information" in this section.

NO - Have your IBM Color Display serviced. See "Service Information" in this section.

28

Turn the Brightness Control fully counterclockwise. Go to Step 29.

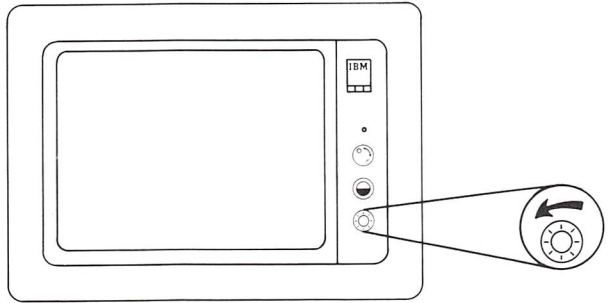

29

Did the characters get darker?

YES - Go to Step 30.

NO - Have your IBM Color Display serviced. See "Service Information" in this section.

30

Turn the Brightness Control fully clockwise. Go to Step 31.

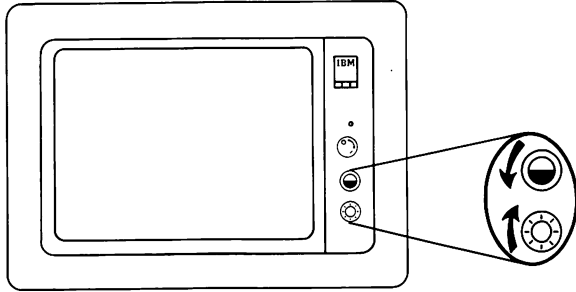

31

Turn the Contrast Control fully counterclockwise. Did the characters get darker?

YES - Go to Step 32.

NO - Have your IBM Color Display serviced. See "Service Information" in this section.

Turn the Contrast Control fully clockwise.

Do you have any of the problems shown in the examples below?

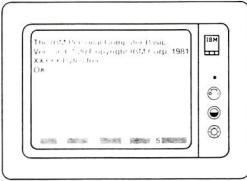

Too Dim

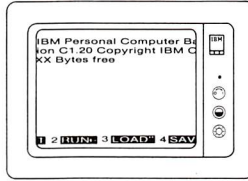

Too Wide

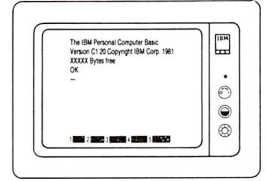

Too Narrow

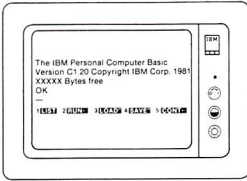

Too Short

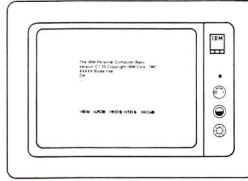

Shrunken

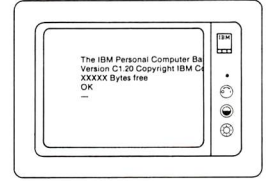

Characters Shifted Left or Right or Up and Down Off the Display Area

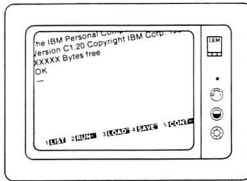

Tilted

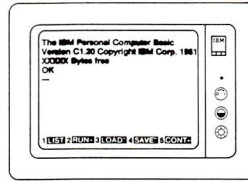

Out of Focus

YES - Have your IBM Color Display serviced. See "Service Information" in this section.

NO - Go to Step 33.

Do you want to run another test?

- YES** Go to "Running the IBM PCjr Tests" in this section.
- NO** If you have a diskette drive installed, you may run the "Exploring the IBM PCjr" diskette at this time. If you have run the "Exploring the IBM PCjr" diskette before, you may continue normal operations.

Test Tag 5 - Light Pen Test

You must have a light pen to run this test.

If, while running the Light Pen Test, you wish to discontinue the test and return to the First IBM PCjr Test Menu Screen, press Fn, then press Break.

Remember, because television and display colors vary, the colors in this book may not match the colors on your screen.

1

Do the shapes of the blocks and lines on your screen match the figure below?

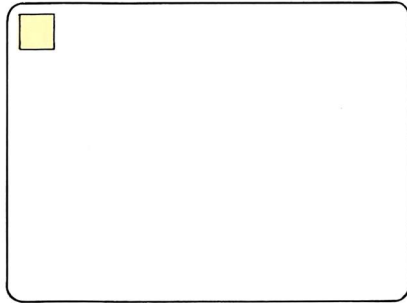

- YES -** You are ready to test your light pen. Press the light pen onto the surface of your screen anywhere in the large block and go to Step 2.
- NO -** Have your IBM PCjr serviced. See "Service Information" in this section.

Did a different shade show within a few inches where the light pen touched the screen?

YES - You may continue pressing your light pen to different places on the large block of the screen. Different areas from left to right will show up in different shades. To clear the shades from the screen and restore the block to one shade, press the light pen to the small block in the upper left hand corner. When you are finished testing your light pen and want to return to the First IBM PC_{jr} Test Menu Screen, press Fn then press Break

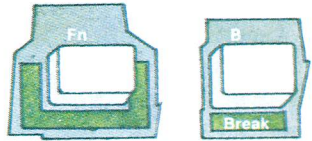

The * under Test Tag "5" for light pen means you have completed the Light Pen Test. Go to Step 3.

NO - Have your IBM PC_{jr} serviced. See "Service Information" in this section.

Do you want to run another test?

YES - Go to "Running the IBM PCjr Tests" in this section.

NO - If you have a diskette drive installed, you may run the "Exploring the IBM PCjr" diskette at this time. If you have run the "Exploring the IBM PCjr" diskette before, you may continue normal operations.

Test Tag 6 - IBM PCjr Attachable Joystick Test

You must have an attachable Joystick installed to run this test.

If, while running the IBM PCjr Attachable Joystick Test you wish to discontinue the test and return to the First IBM PCjr Test Menu Screen, press Fn then press Break.

Remember, because television and display colors vary, the colors in this book may not match the colors on the screen.

- 1 Do the shapes of the blocks and lines on the screen match the shapes of the blocks and lines in the figure below? (You will have a "*" in one or both of the large boxes.)

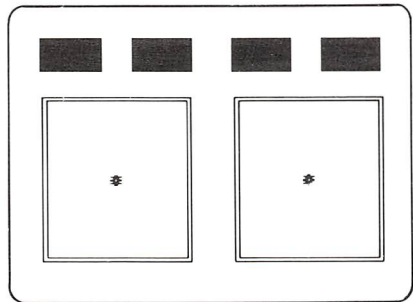

YES - Go to Step 2.

NO - Go to Step 4.

2

This screen represents the Joysticks connected to your IBM PCjr. The two blocks and box on the left of the screen represent the Joystick you have connected to the right connector (viewed from the rear of the system unit). The two blocks and box on the right of your screen represent the Joystick you have connected to the left connector.

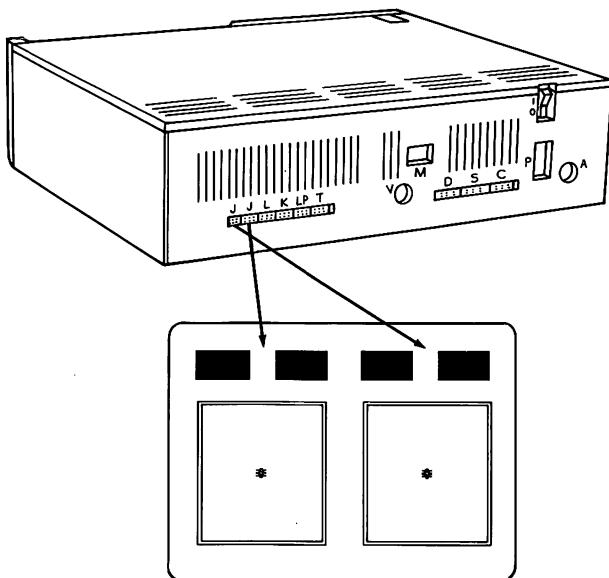

If you have a Joystick connected to the rear of your IBM PCjr, an "*" will appear in the box representing the connector used.

The "*" should be in the center of the box. If it is not, use the centering adjustment levers to center the "*". See the "Centering Adjustment Procedure" in the Attachable Joystick option instructions in Section 5.

The two blocks on the top of the screen represent the buttons on your Joysticks.

Go to Step 3.

3

Press each button on your Joystick, one at a time.

Each block on the top of your screen gets smaller, as if it has been pressed.

The "*" inside each box can be moved by moving the control stick. Move each "*" to the top of its box and around the inside of its box.

Did your Joysticks work correctly?

YES - Press

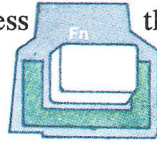

then press

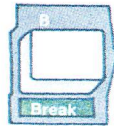

and go to Step 4.

NO - Have your IBM PCjr and your Joysticks serviced. See "Service Information" in this section.

The First IBM PCjr Test Menu Screen appears with a message under Test Tag "6". The message on the left gives the results of the Joystick Test for the Joystick you have connected to the right connector (viewed from the rear of the system unit). The message on the right gives the result of the Joystick Test for the Joystick you have connected to the left connector. The meaning of these messages is shown below:

- * You have completed the Attachable Joystick Test. Go to Step 5.

- A There is no Joystick in that connector. If you do have a Joystick connected there, make sure it is connected properly. If it is, have your IBM PCjr and your Joystick serviced. See "Service Information" in this section.

- B Have your Joystick serviced. See "Service Information" in this section.

- C Have your IBM PCjr serviced. See "Service Information" in this section.

Do you want to run another test?

YES - Go to "Running the IBM PCjr Tests" in this section.

NO - If you have a diskette drive installed, you may run the "Exploring the IBM PCjr" diskette at this time. If you have run the "Exploring the IBM PCjr" diskette before, you may continue normal operations.

Test Tag 9 - Sound Test

If, while running the Sound Test, you wish to discontinue the test and return to the First IBM PCjr Test Menu Screen, press Fn, then press Break.

The Sound Test has 6 parts.

Part 1 tests the speakers in your IBM PCjr, television, and any external sound system you may have attached to your IBM PCjr. You hear one beep simultaneously sounding from your IBM PCjr and from your television or external sound system. After this part of the Sound Test is complete, a speaker with a flashing "9" underneath it appears on the screen.

1 Did you hear Part 1 of the Sound Test?

YES - Go to Step 2.

NO - Have your IBM PCjr serviced. See "Service Information" in this section.

2

Part 2 starts as a low-pitched sound from your speaker. The sound's pitch increases smoothly until it reaches a peak, stays steady for a second and then diminishes until the sound is gone. After this part of the Sound Test is complete, a second speaker with a flashing "9" underneath it appears on the screen.

Press

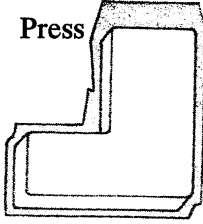

Did you hear Part 2 of the Sound Test?

YES - Go to Step 3.

NO - Go to Step 7.

3

Part 3 sounds the same as Part 2. It starts as a low-pitched sound from your speaker. The sound's pitch increases smoothly until it reaches a peak, stays steady for a second and then diminishes until the sound is gone. After this part of the Sound Test is complete, a third speaker with a flashing "9" underneath it appears on the screen.

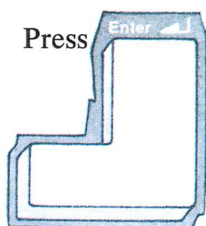

Did you hear Part 3 of the Sound Test?

YES - Go to Step 4.

NO - Go to Step 7.

4

Part 4 sounds the same as Part 2. It starts as a low-pitched sound from your speaker. The sound's pitch increases smoothly until it reaches a peak, stays steady for a second and then diminishes until the sound is gone. After this part of the Sound Test is complete, a fourth speaker with a flashing "9" underneath it appears on the screen.

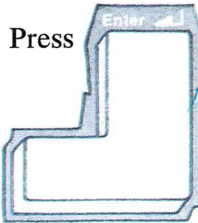

Did you hear Part 4 of the Sound Test?

YES - Go to Step 5.

NO - Go to Step 7.

5

Part 5 sounds like a motorcycle gradually gaining speed, remaining at that speed (pitch) for a second, and then fading away. After this part of the Sound Test is complete, a fifth speaker with a flashing "9" underneath it appears on the screen.

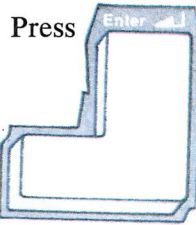

Did you hear Part 5 of the Sound Test?

YES - Go to Step 6.

NO - Go to Step 7.

6

Part 6 is a burst of sound that sounds like a television turned to a blank channel. After this part of the Sound Test is complete, the First IBM PCjr Test Menu Screen appears.

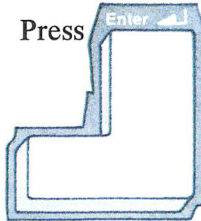

Did you hear Part 6 of the Sound Test?

YES - Go to Step 12.

NO - Go to Step 7.

7

If you are using a television go to Step 8.

If you are using a display with no external sound connected to the rear of your IBM PCjr, go to Step 10.

If you have an external sound system connected to the rear of your IBM PCjr, go to Step 11.

- 8** Is the volume control adjusted to a mid-volume range?
- YES -** Go to Step 9.
- NO -** Adjust the volume and return to "Running the IBM PCjr Tests " in this section and select this test again.
- 9** Disconnect your television from your IBM PCjr and check the sound on your television.
- Is the sound on your television working properly?
- YES -** Have your IBM PCjr and IBM Connector for Television serviced. See "Service Information " in this section.
- NO -** You can use your IBM PCjr without sound. If you want to hear Parts 2 through 6 of the Sound Test you will have to connect your IBM PCjr to a working television. Go to Step 13.

10

If you are using a display without an external sound system, Parts 2 through 6 of the Sound Test will not be heard. If you want to hear parts 2 through 6 of the Sound Test, you will have to connect an external sound system to the rear of your IBM PCjr. You can use your IBM PCjr with a display without an external sound system connected. Go to Step 13.

11

Connect your external sound system to another sound output device to determine if it is working properly.

Is your external sound system working properly?

YES - Have your IBM PCjr serviced. See "Service Information" in this section.

NO - Connect a working external sound system to your IBM PCjr and return to "Running the IBM PCjr Tests" in this section, and select this test again.

12

A message appears underneath Test Tag "9" for Sound. The meaning of the message is shown below:

- * You have completed the Sound Test. Go to Step 13.
- ? You have interrupted the Sound Test before it was completed by pressing Fn and then pressing Break. If you wish to complete the Sound Test, return to "Running the IBM PC_{jr} Tests" in this section, and select this test again.

13

Do you want to run another test?

- YES - Go to the "Running the IBM PC_{jr} Tests" in this section.
- NO - If you have a diskette drive installed, you may run the "Exploring the IBM PC_{jr}" diskette at this time. If you have run the "Exploring the IBM PC_{jr}" diskette before, you may continue normal operations.

Notes:

Test Tag J - IBM PCjr Keyboard Test

If, while running the IBM PCjr Keyboard Test, you wish to discontinue the test and return to the First IBM PCjr Test Menu Screen, press Fn, then press Break. Press Fn, then press Break again.

Remember, because television and display colors vary, the colors in this book may not match the colors on the screen.

- 1 Does the screen match the example below?

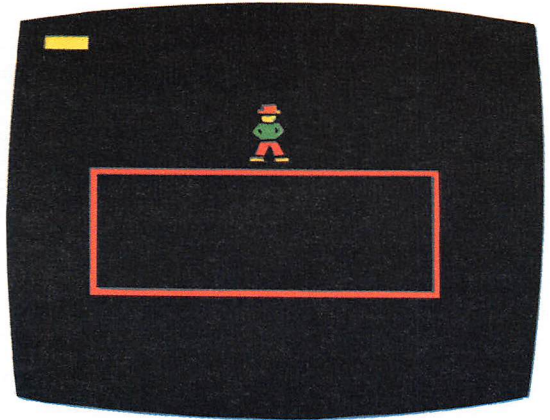

YES - Go to Step 2.

NO - Have your IBM PCjr serviced. See "Service Information" in this section.

2

Press the keys you wish to test. As you do, the character for each key you pressed appears at the top of the screen.

Are all the characters for the last keys you pressed displayed at the top of the screen?

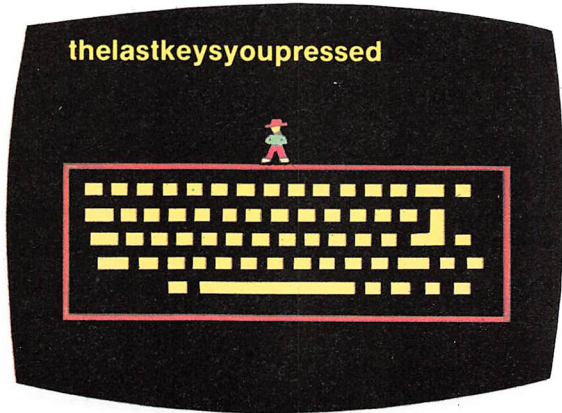

YES - Go to Step 3.

NO - Have your IBM PCjr serviced. See "Service Information" in this section.

3

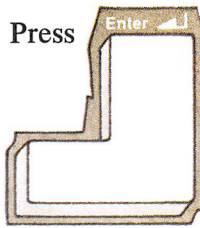

Press and hold the J key. The "J" appears at the top of the screen and continues to repeat while you press it.

Did the "J" continue to repeat while you pressed the J key?

YES - Press

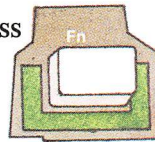

Then press

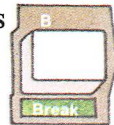

Note: You may need to press the Fn and Break keys a second time.

Go to Step 4.

NO - Have your IBM PCjr serviced. See "Service Information" in this section.

The First IBM PCjr Test Menu Screen appears with a message under Test Tag "J". The meaning of this message is shown below:

- * Your IBM PCjr and keyboard are working properly. (If you have done this test without the optional IBM PCjr Keyboard Cord and you have the optional IBM PCjr Keyboard Cord, go to step 5.)

- B If you are using a cord with your IBM PCjr keyboard, have your IBM PCjr serviced. Refer to "Service Information" in this section.

If you are not using a cord with your IBM PCjr keyboard, this error can be caused by one of the following:

- Direct Sunlight
- Bright florescent light
- Keyboard not lined up with the IBM PCjr
- Keyboard batteries are low or bad

If one or more of these conditions exist, correct the condition and return to "Running the IBM PCjr Tests" in this Section and select this test again. If none of these

conditions exist, have your IBM PCjr serviced. See "Service Information" in this section.

- 5** The following steps are for the optional IBM PCjr Keyboard Cord only. If you do not want to run the Keyboard Test with a keyboard cord, go to Step 10.

Turn your IBM PCjr power off. Go to Step 6.

- 6** Connect the end of your IBM PCjr Keyboard Cord marked "K" to the connector marked "K" on the rear of your IBM PCjr. Connect the other end of your IBM PCjr Keyboard Cord to your IBM PCjr Keyboard.

7 Turn your IBM PCjr power on.

8 When the IBM Personal Computer BASIC Message Screen appears, press and hold

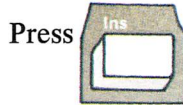
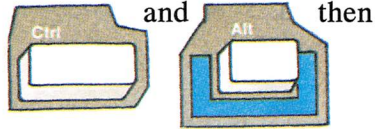

9 The First IBM PCjr Test Menu Screen appears. Select Test Tag J and press Enter. Return to IBM PCjr Keyboard Step 1.

Do you want to run another IBM PCjr test?

YES - Go to "Running the IBM PCjr Tests" in this section.

NO - If you have a diskette drive installed, you may run the "Exploring the IBM PCjr" diskette at this time. If you have run the "Exploring the IBM PCjr" diskette before, you may continue normal operations.

Notes:

Test Tag G - IBM PCjr Internal Modem Test

If, while running the IBM PCjr Internal Modem Test, you wish to discontinue the test and return to the First IBM PCjr Test Menu Screen, press Fn, then press Break.

1 Your screen looks like this.

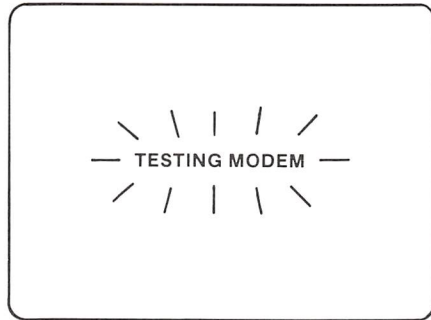

It takes almost three minutes to test your modem. After your IBM PCjr has finished testing your modem, the First IBM PCjr Test Menu Screen appears with a message under Test Tag "G". The meaning of that message is shown below:

- * Your modem is operating correctly. Go to Step 3.

- A Your IBM PCjr does not know you have a Modem attached. Make sure your Internal Modem is not connected to your telephone jack. If it is not connected to your telephone jack, have your IBM PCjr serviced. See "Service Information" in this section.

- B Have your IBM PCjr serviced. See "Service Information" in this section.

- C Your Modem detected a dial tone. If your telephone line is connected to your Modem, disconnect it and go to "Running the IBM PCjr Tests" in this section and select the Modem test again. If your telephone line is not connected to your Modem, have your IBM PCjr serviced. See "Service Information" in this section.

- D Have your IBM PCjr serviced. See "Service Information" in this section.

3

Do you want to run another test?

YES - Go to "Running the IBM PCjr Tests" in this section.

NO - If you have a diskette drive installed, you may run the "Exploring the IBM PCjr" diskette at this time. If you have run the "Exploring the IBM PCjr" diskette before, you may continue normal operations.

Notes:



Test Tag A - IBM Personal Computer Graphics Printer Test

Before beginning the IBM Personal Computer Graphics Printer Test, make sure your Printer power is turned on.

Your screen remains blank during the Printer Test.

1 Does your Printer begin to print?

YES - Go to Step 2.

NO - Go to Step 3.

Does your printout match the sample below?

```

!"#$%&'()*+,-./
0123456789:;<=>?
@ABCDEFGHIJKLMNO
PQRSTUVWXYZ[\]^_
'abcdefghijklmnop
pqrstuvwxyz{|}~
!"#$%&'()*+,-./
0123456789:;<=?
@ABCDEFGHIJKLMNO
PQRSTUVWXYZ[\]^_
'abcdefghijklmnop
pqrstuvwxyz{|}~
!"#$%&'()*+,-./
áíóúñçâäåöçèéêëìíîï
ΣπρσςΣβΓσζαεοΩ
□ □ □ □

```

YES - Go to Step 3.

NO - Go to "Graphics Printer Checkout Procedure" in this section.

When the Second IBM PCjr Test Menu Screen reappears there is a message under Test Tag "A". The meaning of this message is shown below:

- * You have completed the Graphics Printer Test. Go to Step 4.
- A Have your IBM PCjr serviced. See "Service Information" in this section.
- B Your printer is out of paper. Load paper into your printer properly and go to "Running the IBM PCjr Tests" in this section, select the Graphics Printer Test again. If the paper is loaded and the Graphics Printer Test results in a "B", have your printer serviced. See "Service Information" in this section.

C Go to "IBM Graphics Printer Checkout Procedure" in this section

D or E Have your IBM PCjr serviced. See "Service Information" in this section.

4

Do you want to run another test?

YES - Go to "Running the IBM PCjr Tests" in this section.

NO - If you have a diskette drive installed, you may run the "Exploring the IBM PCjr" diskette at this time. If you have run the "Exploring the IBM PCjr" diskette before, you may continue normal operations.

IBM Graphics Printer Check Out Procedure

CAUTION

When you are asked to remove the printer signal cable, always turn your printer power and your IBM PCjr power off.

Any help you will need to run the Printer Self-Test or load supplies can be found in your IBM Graphics Printer Installation and Operating Instructions inserted in Section 5 "The IBM PCjr Options."

You may lose information if the Printer power is turned off while you are sending information to the printer from your IBM PCjr.

- 1 Turn your IBM PCjr power and your printer power off.

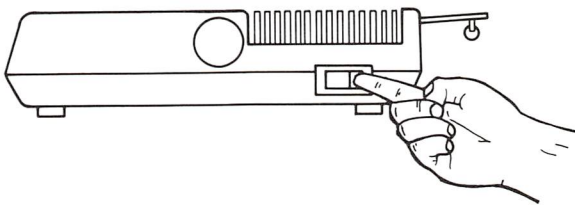
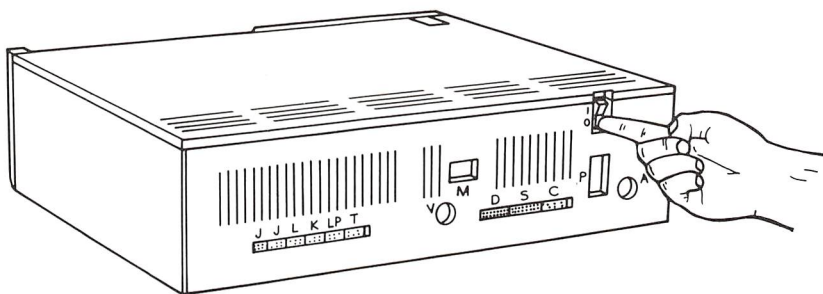

Testing

2

Disconnect the printer cable from the printer.

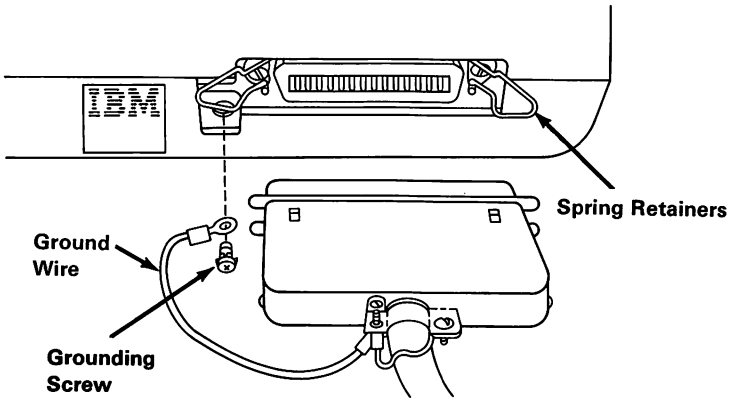

3

Plug your printer power cord into a working wall outlet.

4

Run the Printer Self-Test. If you need help to do this, go to the IBM Graphics Printer Installation and Operating Instructions in Section 5, "The IBM PC_{jr} Options."

Did the Printer Self-Test run without failures?

YES - Go to Step 10.

NO - Go to Step 5.

- 5 Be sure that your ribbon is installed properly.
- 6 Be sure that your paper forms are inserted properly.
- 7 Be sure that there is nothing in the way that will keep your paper forms from moving.
- 8 Be sure that the tractors are adjusted properly.

If you need help with any of the above, see the IBM Graphics Printer Installation and Operating Instructions in Section 5, "The IBM PCjr Options."

Did you find any problems while following the above steps?

YES - Correct the problem. Go to Step 11.

NO - Go to Step 9.

9

Does your printer have any of the following problems? .

- Your printer beeps even though the paper is installed properly.
- Your printer does not beep when it is out of paper.
- Some of the lights on the control panel do not work.
- Your printer continues to print when it is out of paper.

YES - Have your printer serviced. See "Service Information" in this section.

NO - Go to Step 10.

10

Your printer is also controlled by program commands from the system unit. If you have a printer problem only while running a particular program, check the program thoroughly for commands being sent to the printer that may cause it to produce undesired results.

Do you want to run the Graphics Printer Test again?

- YES -** Go to "Running the IBM PCjr Tests" in this section.
- NO -** If you have a diskette drive installed, you may run the "Exploring the IBM PCjr" diskette at this time. If you have run the " Exploring the IBM PCjr diskette before, you may continue normal operations.

Notes:



SECTION 7. CARTRIDGES

Contents

Introduction	7-3
How to Handle Cartridges	7-5
How to Insert and Remove Cartridges	7-6
To Insert a Cartridge	7-6
To Remove a Cartridge	7-7

Notes:



Introduction

Now that your IBM PCjr is set up and operating correctly, you are ready to load a program. Some programs are recorded on cartridges. This section explains how to handle, insert, and remove cartridges.

Notes:



How to Handle Cartridges



Keep Them Dry

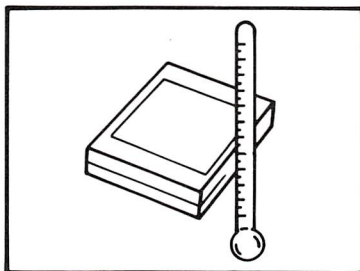

Don't Place Them in the Sun or Near Intense Heat

How to Insert and Remove Cartridges

The cartridge slots on your IBM PCjr are shown below.

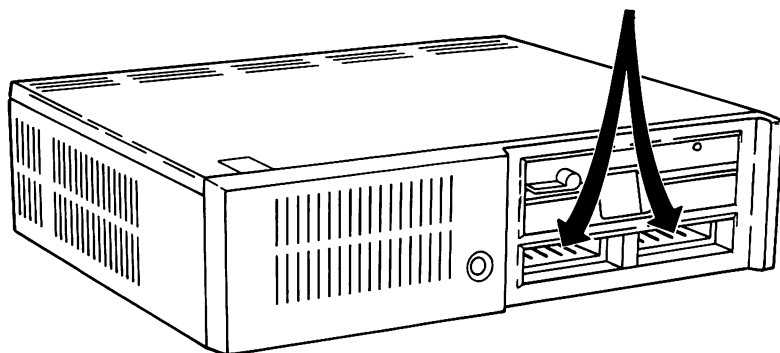

To Insert a Cartridge

- 1** Hold your cartridge with the label side up so you can read it.
- 2** Firmly slide the cartridge into either slot until it snaps in place. If it doesn't snap in place make sure you have the label side up.

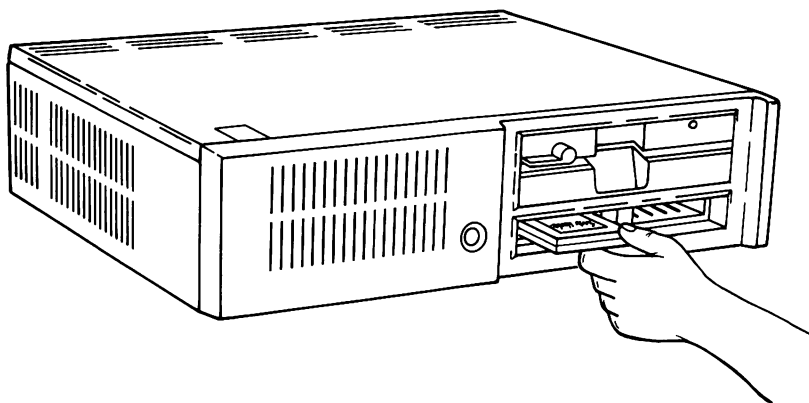

To Remove a Cartridge

Slide the cartridge out of the slot.

You may insert or remove a cartridge at any time. When you insert or remove a cartridge, your IBM PCjr automatically does a **System Reset**. (It behaves as if you just turned your IBM PCjr power on.)

Notes:

Index

A

additional keyboard
 features 3-26
Alt key 2-30
alternate (Alt) key 2-30, 3-19,
 3-20
attachable joystick test 6-87

B

backslash key 2-31
backspace key 2-27, 3-5
BASIC message screen,
 IBM PC 2-5, 6-10
blinking test tags 6-30

C

CapsLock key 2-18, 3-17
cartridge insertion 7-6
cartridge removal 7-7
cartridge slots 7-6
cartridges 7-1
centering information on the
 screen 3-9
chart, keyboard
 differences 4-9

check out procedure, color
 display 6-69
check out procedure, graphics
 printer 6-119
choosing keys 4-1
color bar screen, IBM 2-4,
 6-10, 6-22
color display check out
 procedure 6-69
color display test 6-55
control (Ctrl) key 3-21
Ctrl key 3-21
cursor control keys 2-9, 2-14,
 3-7

D

diskette drive test 6-39
display test, 80 column 6-55

E

enter key 2-20, 3-4
error message table 6-17
escape key 2-6, 3-6

F

failing units, service information 6-37
features, additional keyboard 3-26
first test menu screen 6-26, 6-29
Fn key 2-32
function (Fn) key 2-32, 3-22
function keys 2-33

G

getting started 2-1
graphics printer check out procedure 6-119
graphics printer test 6-115

H

handling cartridges 7-5

I

IBM color bar screen 2-4, 6-10
IBM color display check out procedure 6-69
IBM graphics printer check out procedure 6-119

IBM PC BASIC message screen 2-5, 6-10
IBM PCjr keyboard test 6-103
information, service 6-37
inserting cartridges 7-6
installation 1-5
internal modem test 6-34, 6-111

J

joystick test, attachable 6-87

K

key positions 3-4
keyboard 3-1
keyboard adventure 2-6
keyboard clicker 3-26
keyboard cord option test 6-107
keyboard differences chart 4-9
 how to use 4-6
 when to use 4-5
keyboard legs 3-26
keyboard modes 3-13
 alternate 3-19
 capslock 3-17
 control 3-21

function 3-22
regular 3-14
shift 2-17, 3-15
keyboard test, IBM
PCjr 6-103
keys, typematic 2-25, 3-4

L

light pen test 6-83

M

menu, test screen 6-26, 6-29
modem test, internal 6-34,
6-111
modes, keyboard 3-13
moving the cursor 2-9

O

off symbol 2-5
on symbol 2-5
optional keyboard cord
test 6-107
options 5-1
options tests 6-31

P

power on/off switch 2-5
print screen key 3-5
printer samples 6-116
printer test, graphics 6-115
program cartridges 7-3

R

regular mode, keyboard 3-14
removing cartridges 7-7
reset, system 3-25
running the IBM PCjr
tests 6-21
running the keyboard
adventure 2-6

S

samples, printer 6-116
second test menu screen 6-27,
6-29
service information 6-37
setting up your IBM PCjr 1-1
shift key 2-17, 3-15
slots, cartridge 7-6
sound test 6-93
spacebar 2-28, 3-5
speaker test 6-93
system reset 3-25
system reset keys 2-41

T

- tab key 3-6
- table, error message 6-17
- television and 40CD
 - test 6-45
- test menu screens 6-29
- test tag 6-27, 6-30
- testing your IBM PCjr 6-1
 - first things first 6-5
- testing your IBM PCjr
 - menu 6-27
- tests
 - attachable joystick 6-87
 - color display 6-55
 - diskette drive 6-39
 - graphics printer 6-115
 - internal modem 6-111
 - keyboard 6-103
 - light pen 6-83
 - sound 6-93
 - television and 40CD 6-45
 - 80CD test 6-55
- typematic 2-25, 3-4

U

- using cartridges 7-6
- using the keyboard 3-4

Numerals

- 40-column display and TV
 - test 6-45
- 80 column display test 6-55

Reader's Comment Form

GUIDE TO OPERATIONS

6322959

Your comments assist us in improving the usefulness of our publication; they are an important part of the input used for revisions.

IBM may use and distribute any of the information you supply in any way it believes appropriate without incurring any obligation whatever. You may, of course, continue to use the information you supply.

Please do not use this form for technical questions regarding the IBM Personal Computer or programs for the IBM Personal Computer, or for requests for additional publications; this only delays the response. Instead, direct your inquiries or request to your authorized IBM Personal Computer dealer.

Comments:



**NO POSTAGE
NECESSARY
IF MAILED
IN THE
UNITED STATES**

BUSINESS REPLY MAIL
FIRST CLASS PERMIT NO. 321 BOCA RATON, FLORIDA 33432

POSTAGE WILL BE PAID BY ADDRESSEE

IBM PERSONAL COMPUTER
SALES & SERVICE
P.O. BOX 1328-C
BOCA RATON, FLORIDA 33432

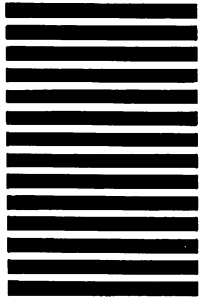

Fold here

Tape

Please do not staple

Tape

Reader's Comment Form

GUIDE TO OPERATIONS

6322959

Your comments assist us in improving the usefulness of our publication; they are an important part of the input used for revisions.

IBM may use and distribute any of the information you supply in any way it believes appropriate without incurring any obligation whatever. You may, of course, continue to use the information you supply.

Please do not use this form for technical questions regarding the IBM Personal Computer or programs for the IBM Personal Computer, or for requests for additional publications; this only delays the response. Instead, direct your inquiries or request to your authorized IBM Personal Computer dealer.

Comments:

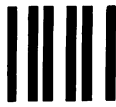

**NO POSTAGE
NECESSARY
IF MAILED
IN THE
UNITED STATES**

BUSINESS REPLY MAIL
FIRST CLASS PERMIT NO. 321 BOCA RATON, FLORIDA 33432

POSTAGE WILL BE PAID BY ADDRESSEE

IBM PERSONAL COMPUTER
SALES & SERVICE
P.O. BOX 1328-C
BOCA RATON, FLORIDA 33432

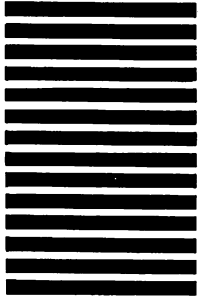

Fold here

Tape

Please do not staple

Tape

Reader's Comment Form

GUIDE TO OPERATIONS

6322959

Your comments assist us in improving the usefulness of our publication; they are an important part of the input used for revisions.

IBM may use and distribute any of the information you supply in any way it believes appropriate without incurring any obligation whatever. You may, of course, continue to use the information you supply.

Please do not use this form for technical questions regarding the IBM Personal Computer or programs for the IBM Personal Computer, or for requests for additional publications; this only delays the response. Instead, direct your inquiries or request to your authorized IBM Personal Computer dealer.

Comments:



**NO POSTAGE
NECESSARY
IF MAILED
IN THE
UNITED STATES**

BUSINESS REPLY MAIL
FIRST CLASS PERMIT NO. 321 BOCA RATON, FLORIDA 33432

POSTAGE WILL BE PAID BY ADDRESSEE

IBM PERSONAL COMPUTER
SALES & SERVICE
P.O. BOX 1328-C
BOCA RATON, FLORIDA 33432

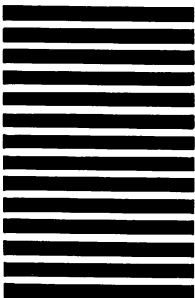

Fold here

Tape

Please do not staple

Tape

Reader's Comment Form

GUIDE TO OPERATIONS

6322959

Your comments assist us in improving the usefulness of our publication; they are an important part of the input used for revisions.

IBM may use and distribute any of the information you supply in any way it believes appropriate without incurring any obligation whatever. You may, of course, continue to use the information you supply.

Please do not use this form for technical questions regarding the IBM Personal Computer or programs for the IBM Personal Computer, or for requests for additional publications; this only delays the response. Instead, direct your inquiries or request to your authorized IBM Personal Computer dealer.

Comments:

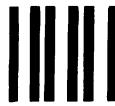

**NO POSTAGE
NECESSARY
IF MAILED
IN THE
UNITED STATES**

BUSINESS REPLY MAIL
FIRST CLASS PERMIT NO. 321 BOCA RATON, FLORIDA 33432

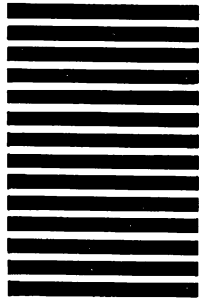

POSTAGE WILL BE PAID BY ADDRESSEE

IBM PERSONAL COMPUTER
SALES & SERVICE
P.O. BOX 1328-C
BOCA RATON, FLORIDA 33432

Fold here

Tape

Please do not staple

Tape

Reader's Comment Form

GUIDE TO OPERATIONS

6322959

Your comments assist us in improving the usefulness of our publication; they are an important part of the input used for revisions.

IBM may use and distribute any of the information you supply in any way it believes appropriate without incurring any obligation whatever. You may, of course, continue to use the information you supply.

Please do not use this form for technical questions regarding the IBM Personal Computer or programs for the IBM Personal Computer, or for requests for additional publications; this only delays the response. Instead, direct your inquiries or request to your authorized IBM Personal Computer dealer.

Comments:



**NO POSTAGE
NECESSARY
IF MAILED
IN THE
UNITED STATES**

BUSINESS REPLY MAIL
FIRST CLASS PERMIT NO. 321 BOCA RATON, FLORIDA 33432

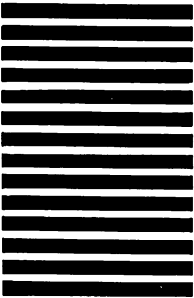

POSTAGE WILL BE PAID BY ADDRESSEE

IBM PERSONAL COMPUTER
SALES & SERVICE
P.O. BOX 1328-C
BOCA RATON, FLORIDA 33432

Fold here

Tape

Please do not staple

Tape

Reader's Comment Form

GUIDE TO OPERATIONS

6322959

Your comments assist us in improving the usefulness of our publication; they are an important part of the input used for revisions.

IBM may use and distribute any of the information you supply in any way it believes appropriate without incurring any obligation whatever. You may, of course, continue to use the information you supply.

Please do not use this form for technical questions regarding the IBM Personal Computer or programs for the IBM Personal Computer, or for requests for additional publications; this only delays the response. Instead, direct your inquiries or request to your authorized IBM Personal Computer dealer.

Comments:

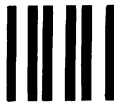

**NO POSTAGE
NECESSARY
IF MAILED
IN THE
UNITED STATES**

BUSINESS REPLY MAIL
FIRST CLASS PERMIT NO. 321 BOCA RATON, FLORIDA 33432

POSTAGE WILL BE PAID BY ADDRESSEE

IBM PERSONAL COMPUTER
SALES & SERVICE
P.O. BOX 1328-C
BOCA RATON, FLORIDA 33432

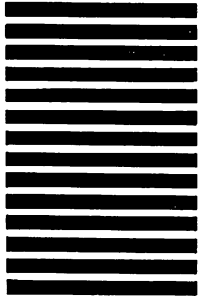

Fold here

Tape

Please do not staple

Tape





International Business Machines Corporation

P.O. Box 1328-W
Boca Raton, Florida 33432

6322959

Printed in United States of America