

PCjr POWER

COPYRIGHT (c) 1989
BY; ALBERT L. ALLEN

ACKNOWLEDGMENTS AND SPECIAL THANKS

My many thanks go out to all of those who have helped me compile, formulate or present this book.

Tom Crider
jrNEWSLETTER Magazine

Ed Strauss
E.S. Quality Products

John King
SAN FRANCISCO PCjr Users Group
(Keep me straight John)

Carl Haub
METRO PCjr Users Group

THE ATLANTA PCjr Users Group

Tom Skladany and Crew
AMERICAN SPEEDY PRINTING
Columbus Ohio
(Printers Extraordinar)

The Groups from TEXAS, BOSTON and OHIO

My Very Supportive and Hard Working Family

IBM and IBM PC Junior are trademarks of the IBM Corporation.

MS and Microsoft Junior Booster are trademarks of the MICROSOFT Corporation.

TM, Tecmar Junior Captain and Junior Wave are trademarks of the TECMAR Corporation.

INTRODUCTION

Thank you for purchasing PCjr Power. This book and the software is a compilation of more than a years work combined with six years of experience with the Junior, engineers, users groups and Juniors owners. The PC Junior is a great piece of computer architecture and it enjoys one of the top spots among a host of computer hardware. Rightfully so.

PC Junior owners have been a constant source of inventive information when attempting to overcome the design problems thought to limit the Juniors ability. I have just scratched the surface in the compilation of helpful items within this book, but I certainly hope this information is helpful to both the novice and experienced users who have constantly sought to upgrade their great little computers.

Continue to seek excellence,

Albert L. Allen President
Owl Software

Printed 1989
Copyright (C) 1989
by Owl Software
Albert L. Allen

TABLE OF CONTENTS

INTRODUCTION

AROUND THE JUNIOR

Connector Port Layout	1
Keyboard Routines	3
Parts and Part Numbers	5

DISK OPERATING SYSTEM

Understanding DOS	6
Autoexec and Configuration Files	17
The Command Interpreter	20
Using DOS 3.2 and 3.3	22

HINTS AND HELPS

Replacing Disk Drives	24
256K Chip Handling	25
Cure for Monitor Smearing	26
Communications Hints	27
Curing Noisy Disk Drives	29
Cleaning the Disk Drive	31
Tecmar Memory Overheating	31
Damaged Rear Connectors	32
Static/Errant Electrical Charges	32
Speeding Up the Junior	33
Hardware Sources	34
Monthly Newsletter Available	34

JUNIOR MODIFICATIONS

Using 736K Through Sidecar Modification	36
Adding a Reset Button	37
Tandy 1000 Upgrade	39
Adding a Second Disk Drive	40
Disk Controller Card Modification	41
Making a Two Drive Cable	47
512K IBM Sidecar Upgrade	49
512K Microsoft Upgrade	53
V20 Chip Addition	56

SOFTWARE PATCHES

DOS 2.1	60
Arctic Fox	62
Newsroom	63
Print Master	64

Print Shop	64
Acient Art of War	65
Electric Desk	66
Writing Assistant	67
Filing Assistant	68
Reporting Assistant	69
Graphing Assistant	69
PFS File	70
PFS Report	71
PFS Write	72
Homeword	72
Enable	73
<u>BASIC PROGRAMMING HINTS</u>	74
<u>COMPATIBILITY LISTING</u>	81
<u>PCjr POWER SOFTWARE</u>	90
<u>NEW ADDITIONS</u>	
Tandy Modification Precautions	A1
Building a Serial Port Card	A2
A New Second Drive Controller Modification	A7
Controller Modification for Three Drives	A12
Two and Three Drive Cable Construction	A15
Additional Parts and Part Numbers	A19
PCjr Diagnostic Outline	A20
Common PCjr Repair Problems	A21
Additional Monitor Problems/Cures	A23
Monitor Data	A24
Software Patches	A25
F-19, Kings Quest 4, Sierra and Prodigy	
Miscellaneous Information	A29
Joy Port Info, Genius Mouse Use, Higher Speeds for the Jr Captain, Video Gate Array Problems, Checking for a Speech Adapter, Cartridge Dump to Disk File	
Additional Program Compatability Listing	A32

DISCLAIMER:

Owl Software is not responsible for any modification made to software or hardware from the contents of this book.

IBM PCjr CONNECTOR PORT LAYOUT

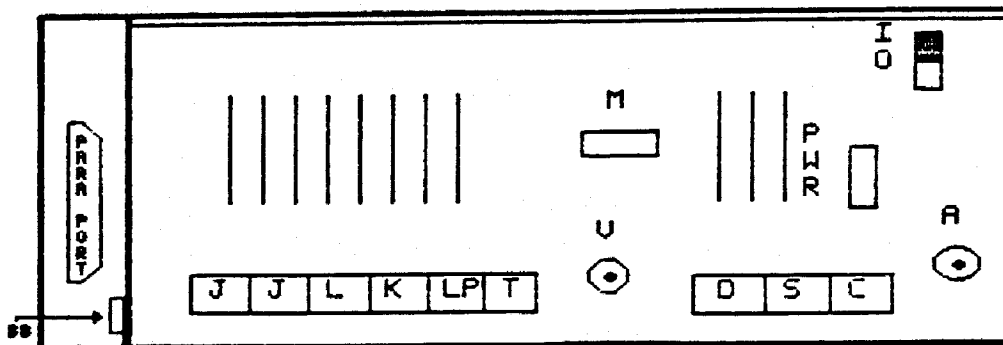

IBM PCjr REAR CONNECTORS

Starting in the front of the PCjr and located to the right beneath the disk drive there are two cartridge slots for ROM cartridge programs like BASIC, Lotus and many games. These slots are also used to house the many new third party configuration cartridges and ROM clocks. There is also a plug-in to double each slot space called a Siamese Slot which allows each single slot accept two cartridges.

The IR (infra-red) port which receives information from the keyboard is the 3/8" hole located just to the left of the cartridge ports. If you are using the standard PCjr keyboard you can put 4 AA batteries into it and access the computer without a physical cable attached from the keyboard to the computer. There is a keyboard adapter which will replace the IR internal detector. This adapter will allow a PC-XT style 84 or 101 key keyboard to be used with the Junior and will also provide a keystroke buffer which will accept input while other functions are being processed by the CPU.

On the right side of the computer under a snap off side cover is located a 60 pin buss connector which is used to attach a great deal of items. These include memory expansion, parallel printer port, power attachment and some hard drives. Caution should be observed when you use this port, and you should avoid touching the pin area as static shock could ruin your system board. If you attach more than two sidecars a extra power supply module should also be added to provide adequate power.

Facing the rear of the computer you will notice six connectors on the left side labeled J,J,L,K,LP and T. The two "J" connectors are for joysticks, left and right. The standard PCjr joystick will fit these connectors. Also there is an adapter available to use a standard PC joystick with either of these connectors. The "L" connector is listed as a spare and I don't know of a use for it. The "K" connector is the standard plug-in for the keyboard cable. The "LP"

connector was originally for light pen use, but it is also used in conjunction with the "K" port for an adapter which allows the connection of a PX-XT style keyboard. The "T" port is used plug in the television adapter which allows use of a TV for a monitor. This port can also be used to adapt a single color TTL monitor to the Junior.

The circular connector labeled "V" in the middle of the back is the the COMPOSITE video port. You can plug a single color composite monitor into this. Above this port is the square connector labeled "M" which is the modem output connection to the telephone line.

The next set of connectors to the right are labeled D,S, and C. The "D" port is the RGB color monitor output. You can use the PCjr color monitor or you can use any standard RGB color monitor with a COLOR ADAPTER CABLE which will allow you to attach it to the "D" port. The "S" connector is the serial port used to attach many items such as a serial printer, mouse, external modem and other serial peripherals. You will need a SERIAL ADAPTER CABLE to adapt the industry standard 25 pin D connectors to the "S" port. The "C" connector is used for cassette recorder storage. With a disk drive this is virtually a unused port.

To the right is the last circular connector labeled with a "A" for audio output. The remaining rectangular connector labeled PWR is the power input to the computer from the external 16.7 volt transformer.

THE INTERNAL 5.25" FLOPPY DRIVE

The standard 1/2 height, 5.25" floppy drive inserted into the PCjr consist of;

- 2 Heads (1 per side)
- 40 Tracks(cylinders) per side
- 9 Sectors per track
- 512 Bytes per sector

The head settle time is 21 milliseconds, motor start is 500 milliseconds. Head load time is not applicable. The unit is BELT driven, and the heads ride on plastic bushings.

IBM PCjr KEYBOARD ROUTINES

The PCjr keyboard is a very unique input device with many routines that emulate the larger PC XT style keyboards and some routines that the larger keyboards do not have. It is important to know your way around the Junior keyboard.

Starting with the Function Keys, the "FN" key in the upper right corner is a STICKY key. This means that when it is pressed it can be released and the next key in the sequence can be pressed without having to hold down the FN key.

To obtain the F1-F10 keys press the FN key and the appropriate number key, 1-0.

To cause a Control Break which ends most programs running in either DOS or BASIC press FN + B (break).

To cause the screen print to Echo to the printer press the FN + E (echo). Everything typed after this command is invoked will print to both the screen and printer. Issue the command again to turn it off.

To Print The Screen contents on the printer press the FN + P (print screen). Make sure the printer is turned on. This is the same command as Shift Print/Screen on the PC XT style keyboards. This will print the 25 lines of screen information that is on the monitor at present.

To Pause a program execution or a scrolling screen, press the FN + Q (pause).

To cause the keyboard to enter the Number Lock Mode you must press and hold the ALTERNATE key then press the FN key then the N key, ALT+FN+N (number lock). Then you can enter any of the 256 ASCII codes by pressing and holding the ALT key along with the ASCII code. When you release the ALT key the character will appear on the screen. For example character 143 will cause most printers to enter the compressed print mode. Echo the keyboard (FN+E) then enter the number lock mode and hold down the ALT key and type 143. A small character will appear on the screen and everything sent to the printer after that will be in the compressed print mode until a reset code is sent or the printer is turned off and back on again. To leave the number lock mode press ALT+FN+N again.

To Reboot (restart) the computer on what is called a warm boot, press CONTROL + ALTERNATE + DELETE keys all together at the same time, CNTL+ALT+DEL (reboot).

To move the Screen Alignment Left or Right press CONTROL + ALTERNATE + either the LEFT or RIGHT ARROW keys.

To enter the PCjr Internal Test Mode, press CONTROL + ALTERNATE + INSERT keys at the same time. Diagnostics will begin from the PCjr internal ROM storage. CNTL+ALT+INS (test mode).

To begin Keyboard Click which issues a sound when you press each key, press CONTROL + ALTERNATE + CAPS LOCK, CNTL+ALT+CAPS LOCK (keyboard click).

To enter the Function Lock Mode which makes the keys 1-0, and the B,Q,P,E and S along with the cursor control keys function as though the FN key were pressed first, press the FN + SHIFT + ESC together. This same key combination will turn off the function lock mode. FN+SHFT+ESC (function lock mode)

IBM PCjr PARTS AND PART NUMBERS

The following is a list of the current parts and parts numbers associated with the PCjr computer. The prices noted are from Owl Software 1435 Burnley Sq. N. Columbus, Ohio 43229 and they are available for immediate shipment. Parts listed as EXCHANGE must have the old part returned to IBM within 30 days receipt of the new item or the full retail price is charged.

ITEM	PART NUMBER
KEYBOARD	6135725 (\$75.00)
KEYBOARD CORD	8285983 (\$19.95)
EXTERNAL POWER TRANSFORMER	8286003 (\$49.00)
POWER BOARD	6135986 (\$44.00 Exchange)
64k MEMORY BOARD	8654227 (\$80.00 Exchange)
INTERNAL MODEM	8654400
INFRA-RED RECEIVER	8654226 (\$22.95)
SYSTEM BOARD	8654225 (\$137.00 Exchange)
DISKETTE DRIVE	8285997 (\$89.00)
DRIVE SIGNAL CABLE	8285986 (\$6.95)
DRIVE MOUNTING BRACKET	8286005 (\$19.95) *Limited Qty
DRIVE FAN ASSEMBLY	8285982 (\$29.00)
DRIVE CONTROLLER CARD	8284228 (\$55.00)
PARALLEL PRINTER PORT	8285987 (\$79.95)
TELEVISION ADAPTER	8285989 (\$19.95)
PCjr JOYSTICK	8286002 (\$27.95)
COLOR ADAPTER CABLE	8285991 (\$26.95)
SERIAL ADAPTER CABLE	8285993 (\$14.95)

All of these parts can still be purchased from IBM Parts Order if they cannot be found from your local PCjr dealers. Prices do not include shipping and are subject to change without notice.

I have taken the time to write this section for all of the computer owners who have troubled, haggled, queried or scratched their heads to get a BEGINNING GRASP of the DOS commands. This section is for any user of PC equipment including PC-XT, AT, Clone or PCjr. It is general in nature and the examples are common to all versions of the DOS language from version 2.0 on.

Remember that the key to mastering these basic techniques is to practice the examples and to envision how they will apply to the work that you have to achieve.

THE KEY TO COMPETENCE IS PRACTICE.

WHAT IS DOS? (Disk Operating System)

DOS is a program (software) that allows you to "talk" with the computer and its peripherals. For example, you talk through the keyboard to the CPU (central processing unit) to the screen, disk drives, printer, modem or monitor and etc. These items are called the computer (hardware).

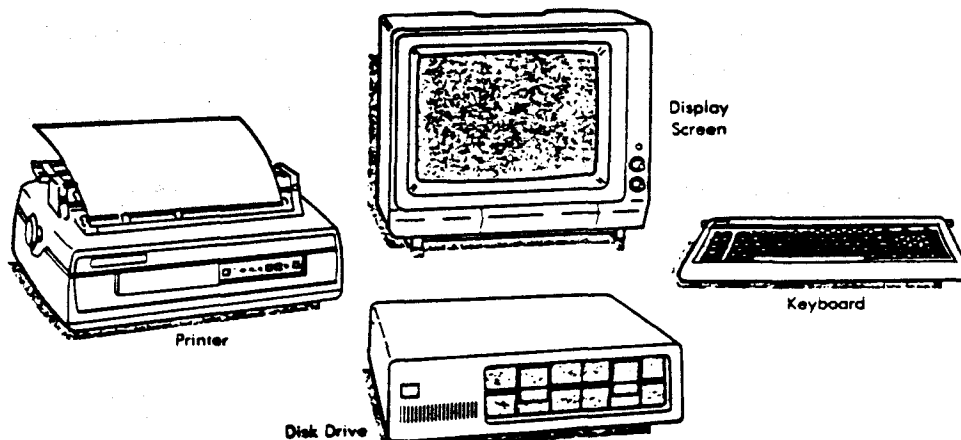

DOS also contains the utility programs for diskette preparation, file organizing and other file manipulations on your diskettes. You give commands with regular words like FORMAT, DISKCOPY, COPY, ERASE or PRINT and DOS carries these commands to the computer to complete the tasks.

There are two forms of DOS commands;

1. **INTERNAL COMMANDS** - stay resident in the computer memory when DOS is started. Ie; (Copy and Dir)
2. **EXTERNAL COMMANDS** - are program files which must be loaded from the DOS diskette each time you use them. In order to use a external command the DOS diskette must be in your disk drive or that program file must be on current diskette you are using. Ie; (Diskcopy and Format)

DOS has many versions and, as the version numbers increase so does the amount of RAM (random access memory) needed to contain the larger DOS programs. Some versions of DOS, like version 3.1 or 3.3, may cause noisy disk drive operation in some computers and special quieting programs are needed to run these disk drives at their normal speeds.

DOS can work much more efficiently with two physical disk drives. But for single disk drive systems, DOS is able to get around this problem by creating two LOGICAL disk drives. Your one physical drive acting as two drives.

In situations involving a single disk drive, DOS uses the same disk drive labels as it does in a two drive setup. The A drive is logical drive A, the B drive is logical drive B. The difference between the two examples is that in the single drive situation both labels refer to the same physical drive instead of two separate drives. When a command using both drive A and drive B is executed, DOS switches the label attached to the one drive as needed. Execution of the command is held up during each switch so that you can swap diskettes in the single drive.

The effect with single drives is that operation that require two diskettes like DISKCOPY, COPY or FORMAT, can be accomplished as though two physical disk drives were present.

STARTING THE DOS PROGRAM

With the computer turned off open the disk drive door on the computer and put your DOS diskette into drive A:. On most PC-XT, AT, or PCjr's the disk goes in with the label UP and the notched edge to the LEFT. Remember not to touch the diskette in its open section where you can see the magnetic film of the diskette. This will make the diskette unusable.

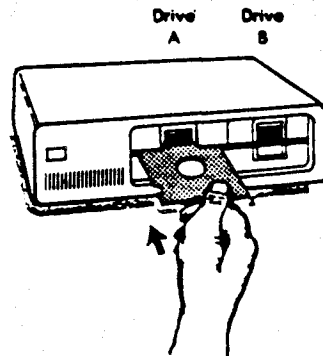

1. Place operating system diskette in drive A.
2. Close drive door.
3. Turn on power.
4. Relax and wait.

Close the disk drive door and turn your computer and monitor on. After your computer checks itself and counts the memory, the disk drive light will come on and the DOS program will start to load into the RAM memory. Usually DOS will clear the screen and you will see the following message;

Current date is Monday 01-01-80 (maybe any date)
Enter new date (mm-dd-yy):_

The CURSOR will be positioned after the colon. (The cursor is the small blinking character that shows where the next character will be placed on the screen.)

You will need to enter the date using the format of month, day and year, i.e.; 03-06-87 or 12-25-88. When you type in these characters the cursor moves along always one place ahead of the last character that you typed in. When you are finished typing in the date, DOS is waiting for you to give it a command to execute the order. You must strike the ENTER or RETURN key telling DOS to execute the command or function you just typed.

In this manual, anytime that you see;

<ENTER>

it means to strike the ENTER or RETURN key and give DOS the (execute command.)

You will find that DOS requires the proper spelling and the correct syntax (order) to process your commands. You may make correction in the command line using the BACKSPACE or ARROW KEYS anytime before hitting <ENTER>.

The next message you will see is;

Current time is 06:05:30 (may be anytime)
Enter new time:_

The time format is; hours: minutes: seconds: hundredths of seconds. DOS uses military time or the 24 hour clock. For example 11 a.m. will be displayed as 1100 or 6 a.m. will be displayed as 0600, but 1 p.m. will be displayed as 1300 and 2 p.m. as 1400 and so on. So the afternoon hours will have 12 added to them. You may set the DOS clock by typing in the hours and minutes and you may add seconds as a option. If the actual time is 4:15 p.m. you would type in;

Enter new time:16:15 <ENTER>

You will now see the version screen with the DOS prompt. The version screen shows the current version of DOS that you are using followed by the DOS prompt which indicates the current (DEFAULT) disk drive you are using;

The AAA Personal Computer **-DOS
Version 2.10 Copyright XXXXXX Corp. 1983, 1984

A>_

The cursor is positioned after the DOS prompt and DOS is now ready to accept your commands.

Congratulations, you have successfully loaded DOS into the computers memory. This process is also called "BOOTING" your computer. It is also called a "COLD BOOT" because you started with the power off to the computer. You may begin the process again in what is called a "WARM BOOT" by pressing and holding the CONTROL with the ALTERNATE and DELETE keys simultaneously and releasing them.

TRY THE WARM BOOT HERE (CTRL-ALT-DEL)

NOTE: You may simply strike <ENTER> at both the date and time prompt if you don't want to put in these items. If your computer has a clock and calendar board the correct date and time might be kept in the computer memory and you pass the date and time entry in the "boot" and come directly to the DOS prompt ready to enter commands.

On some computers your screen will be in the 40 column wide mode on boot up. Some Tandy and IBM PCjr's are this way. You can place the screen into the 80 column wide mode by typing;

A> MODE CO80 <ENTER> (for color monitors) or

A> MODE 80 <ENTER> (for monochrome monitors)

MODE is a external DOS command so your DOS diskette should be in the disk drive to complete this procedure. NOTE: Your computer should be used from the 80 column mode to be compatible with the majority of business software which requires starting at the 80 column screen.

THE BEGINNERS TOOLBOX

There are six commands that you must learn to use effeciently to start getting a grasp of DOS. These commands are DIRectory, DISKCOPY, FORMAT, COPY, TYPE and CHKDSK (Check Disk). We will cover these six commands next.

Now we are ready to start using DOS to communicate with the computer. Lets give DOS your first real command. At the A prompt type;

A>DIR <ENTER>
What happened?

The disk drive light came on and a listing of the files contained on your DOS diskette appeared on the screen. You asked DOS to print a (DIR)ectory of the material contained on the diskette in the default disk drive. If your DOS diskette contained a lot of files the upper ones probably scrolled off of the screen before you had a chance to see them.

Let's try the DIR command again, but with a small addition;

9 A>DIR/P <ENTER>

This time the disk directory is displayed, but at the end of a full screen of file listings the computer stopped and asked you when you are ready to continue. You have used the (DIR)ectory command with the (P)age option.

Normally these type of options, placed after the command and used with a slash, are called SWITCHES. When the (P) option is used it is said that the (P)age switch is turned on.

There is another nice switch associated with the DIR command, try this one;

```
A>DIR/W <ENTER>
```

Notice that the disk directory this time was printed to the screen in the (W)ide fashion that covers the width of the screen. If a diskette directory is extremely large the two switches can be used together;

```
A>DIR/W/P <ENTER>
```

This command will produce a diskette directory in the wide style that will pause when the screen is full.

If you have two physical disk drives and you wanted to see the files contained on drive B, you can do either of two things;

```
A>DIR B:(SWITCHES AS NEEDED) <ENTER> or
```

```
A>B: <ENTER> this changes the default drive to drive B.
```

```
B>DIR(SWITCHES AS NEEDED) <ENTER>
```

You may change between default drives as simply as indicated above. Just type in the drive letter FOLLOWED BY A COLON and hit enter. If you leave the colon off of the command string you will get a error message, ie;

```
A>B <ENTER>
```

```
Bad command or file name
```

```
A>_
```

You can see that the syntax is VERY important, the computer needs the exact syntax to process you commands.

Notice that in the wide mode the DIR command does not print the file size or orgin date and this save space on the screen or when printing out the directory to a printer. Try this DIR command with other diskettes and view their file directories. While we are discussing files maybe we should look at the importance of file names.

FILES

Files are every group of material stored on the diskette or in the computers memory. Some files may makeup the program that does the work while other files contain the work produced by the programs. These are called output files. An output file maybe a letter you have written with your word processor or a christmas card mailing list you have created with your database. Other files may contain instructions for operating a program these are called documentation files. The factor usually determining the nature of the file is the FILENAME EXTENSION, ie;

`wordproc.doc` The (DOC) extension indicates this file is documentation for the wordproc.com program.

`database.txt` This is a text (TXT) file probably containing instruction for the program called database.exe.

`read.me`
`ins`
`lst`
`hlp` All similar to the above text files.

`wordproc.com` These are DOS binary files. Commonly called programs, they contain no readable text. Normally these programs can be run by typing the filename at the DOS prompt.

`highjump.bas` Basic language program file.

`go.bat` DOS batch procedure file.

There are many filename extensions but these will give you a idea of the indicator that the name extension can used for. If you look at the filename extensions on your DOS diskette you will notice that most of these files are executable only. That means that they are programs as opposed to instructions or other types of files.

DISKCOPY - (external command) is one of the most important tools you can have in your toolbox. Diskcopy makes a exact (clone) copy of a diskette. Only floppy diskettes can be diskcopied.

Lets make a backup copy of your DOS diskette, with that diskette in drive A type:

A>DISKCOPY A: B: <ENTER>

If you have a single disk drive system the message;

Insert source diskette in drive A
Strike any key when ready...

On the single drive setup, for the sake of safety, please remember the difference between the SOURCE (make a copy of) and the TARGET (copy to) diskettes. Place a write protect tab on the SOURCE diskette if needed.

As your computer starts to copy you will be prompted to exchange the two diskettes until copying is complete. On two disk drive systems the SOURCE diskette would be in drive A and the TARGET diskette in drive B. No exchanging of diskettes is necessary.

THIS COMMAND IS THE SINGLE MOST IMPORTANT COMMAND IN MAKING SOFTWARE BACKUPS. With it you can always have a good working diskette from which to boot DOS. Make 2 or 3 backup copies of DOS. Most of your software can be copied using DISKCOPY and it is important to make a backup copy of any newly acquired software before you try running the programs for the first time.

Practice doing some diskcopies of other software that you have. Diskcopy will work whether your TARGET diskette is formatted or not. If your TARGET diskette is not formatted at the beginning of the diskcopy procedure it will be formatted during the routine and this message will appear on the screen;

```
Copying X# Sectors per track
Formatting while copying
```

On single drive setups the diskcopy routine could take a number of disk swaps to complete the entire procedure. After making your backup DOS copies place your original DOS diskette in a safe place and use only your copies to boot your system.

Diskcopy has no SWITCHES to enhance its use, and it will not copy most copyrighted software due to certain protection schemes and procedures.

FORMAT - (external command) before a diskette can store information that is usable by DOS, it must be formatted. While formatting, the diskette is divided into areas called sectors and tracks which can be read and written to by DOS. Formatting also sets up a file allocation table (FAT), a file directory area, and checks the diskette for defects. If defects are found DOS locks them away from the useful storage area. Formatting WILL REMOVE ALL DATA from a diskette

Lets format a few new diskettes, with the DOS diskette in drive A at the prompt type;

```
FORMAT B: <ENTER>
You receive this message,
```

```
Insert new diskette for drive B:
and strike any key when ready.
```

On a single drive system REMOVE your DOS diskette and insert a new diskette to format. Press any key to begin the formatting procedure. On a two drive system, place a new diskette into drive B and press any key. Formatting destroys all existing data on a diskette so make sure that the diskette to be formatted contains no data that you will need again.

DOS will tell you when the formatting is complete;

Formatting..... Format complete

362496 bytes total disk space
362496 bytes available on disk

Format another (Y/N)

Format five or six diskettes at this time to have for practice in later examples.

FORMAT has a number of switches that can be used with it, for example;

/S Is used to add the DOS system files to the diskette being formatted. **THIS DISKETTE CAN THEN BOOT THE COMPUTER.**

/V Is used to add a volume label or name to the diskette. The name is used to identify the diskette and cannot be used as part of the DOS commands. This name can be up to 11 characters long.

/B Is used to format a diskette and leave room to transfer the system (BOOT) files at a later time.

/1 Is used to format 1 side of the diskette only.

/8 Is used to format 8 sectors per track instead of the default 9 sectors per track.

COPY - (internal command) which allows the user to copy individual or groups of files from one diskette or hard drive to another diskette or hard drive. In copying the first drive is called the SOURCE drive and the second drive is called the TARGET drive. COPY can also be used to combine one or more existing files into one file through a process called concatenation. You can also use COPY for the transfer of data between peripheral devices and files.

You can copy a file with the ease by using the command as follows;

A:>COPY ANYFILE.EXT B: <ENTER>

If you have a single disk drive the source diskette should be in drive A, and the diskette that you wish to copy the file to should be ready to insert when the computer prompts you. If you have a dual drive system the source should be in drive A and the target should be in drive B.

If you wished to copy all files with the extension of EXT to drive B: the command is issued as follows;

```
A:>COPY *.EXT B: <ENTER>
```

Copying all files with the filename of ANYFILE is done by this command;

```
A:>COPY ANYFILE.* B: <ENTER>
```

Here is another possibility for a group of files named ANYFILE1.EXT , ANYFILE2.EXT, ANYFILE3.EXT and ANYFILE4.EXT which can be moved with one command;

```
A:>COPY ANYFILE?.EXT B: <ENTER>
```

The asterisk and question mark are called "WILDCARDS". The asterisk is used in place of any word or portion of a word. The question mark is used in place of any single letter. These "wildcards" make copying files easier to do.

You can also rename a file at the time you are moving it by simply adding the newname after you denote the destination drive;

```
A:>COPY ANYFILE.EXT B:NEWFILE.NEW <ENTER>
```

Suppose that you wanted to put two chapters of a book together. If these files contain text only, you can use the COPY command to join them together like this;

```
A:>COPY CHAPT1.TXT+CHAPT2.TXT NEWFILE.TXT <ENTER>
      CHAPT1.TXT
      CHAPT2.TXT
```

2 files copied

NEWFILE would be created on drive A, if you wanted it on a disk in drive B the command would be the same except a B: would be placed in front of NEWFILE.TXT. You list the filenames joined with a plus sign and denote a new filename which the joined files are put into. Of course this will work for a number of files and with the wildcards. Suppose you keep daily expenses in files named after the days of the week, MON.EXP, TUE.EXP, WED.EXP, THUR.EXP and FRI.EXP. The command would be as follows;

```
A:>COPY *.EXP WEEK.DOC <ENTER>
      MON.EXE
      TUE.EXP
      WED.EXP
      THUR.EXP
      FRI.EXP
```

5 files copied

All of the daily files will be combined into the WEEK.DOC file. Notice that the combined filename extension is changed to DOC. This avoids confusion when the wildcard (*) is used. If the combined filename WEEK.EXP is used DOS may attempt to copy the contents of WEEK.EXP into itself.

The important switch associated with the COPY command is the /V switch. It is used to verify the accuracy of the execution of a COPY command. Verification causes the system to run more slowly, verifying the material copied to the original file.

TYPE - (internal command) is used to display the contents of a file on the screen. TYPE is generally used only to show text files. Attempting to show the contents of a executable file will give unexpected results.

The correct syntax for the TYPE command is as follows;

```
A:>TYPE filename.ext <ENTER>
```

or if the file is on the other drive;

```
A:>TYPE B: filename.ext <ENTER>
```

If you want to pause the display press <CNTRL> <S> or <CNTRL> <NUMLOCK>. On some of the new 101 key keyboards you can press the <PAUSE> key to suspend the display. On the PCjr it is (FN+Q). Then press any key to resume the display. Wildcard characters cannot be used with the TYPE command.

If you want to send a text file to the printer you can do it very easily with the COPY command, ie;

```
A:>COPY filename.ext PRN <ENTER>
```

Make sure that your printer is turned on when you push the <ENTER> key. This is a convenient way to copy program instruction to the printer and allow you to read them at your leisure.

CHKDSK - Check Disk (external command) checks the condition of a disk's data. CHKDSK analyzes the FAT, disk directory and sub directories for errors and problems. It also analyzes the total RAM memory and how much RAM memory is available at the time of the CHKDSK command.

The correct syntax for the CHKDSK command is;

```
A:>CHKDSK <ENTER>
```

CHKDSK then gives a status report similar to this;

```
362496 bytes total disk space
 22528 bytes in 2 hidden files
305152 bytes in 50 user files
 34900 bytes available on disk
```

```
262144 bytes total memory
220200 bytes free
```

You may also include a drive letter specifier to run CHKDSK for another drive, ie; CHKDSK B: CHKDSK has two switches available /F and /V you should read up on these in your DOS manual.

FINISHING UP

You can begin by using the commands in the beginners toolbox to copy your PCjr POWER diskettes with the DISKCOPY command then you can read the documentation files (DOC) contained on these disks with the TYPE command or send them to the printer with the COPY command.

Other areas of DOS that you should investigate further on your own include the command areas in; (DEL)ete or ERASE, MAKE DIRECTORY (MD), CHANGE DIRECTORY (CD), REMOVE DIRECTORY (RD), MODE and PRINT.

Also read the sections in this book on the AUTOEXEC.BAT and CONFIG.SYS files for more insight on setting up your computer.

THE AUTOEXEC.BAT AND CONFIGURATION SYSTEM FILES

There are two very important files that are used in controlling the system initialization setup on the PCjr. These files are the CONFIG.SYS and the AUTOEXEC.BAT files.

The CONFIG.SYS is a text file used to store a list of user-inputted device drivers. When you "boot up" your computer DOS checks to see if there is a CONFIG.SYS in the root directory of the boot disk. If so, DOS locates the device drivers following this syntax;

```
DEVICE = path\drive\filename
```

(A DEVICE DRIVER is a computer program that acts as a link between the DOS program and a peripheral device like a disk drive, system clock, console or mouse. Device drivers usually have the filename extension of .SYS)

DOS will search the path and drive to find the appropriate device driver filename to load into the computers memory. I believe that every user of DOS should have a CONFIG.SYS file even if it only contains one line. Suppose that you wanted to create a CONFIG.SYS file on your DOS diskette and the device driver that you are going to call is the ANSI.SYS driver which allows for extended keyboard and display driver control. You can create the CONFIG.SYS file with any text processor like EDLIN or you can use the COPY command to tell the computer to copy what you type on the keyboard like this;

```
A>COPY CON:CONFIG.SYS <ENTER>  
DEVICE = ANSI.SYS ^Z <ENTER>
```

```
1 file copied
```

The (^Z) means for you to press the Function 6 key. It places the end of file marker on the last line of the file and when you press <ENTER> it writes the file named on the first line to the disk. You can use the end of file marker on the next blank line but if it is placed at the end of the last line it supresses the double prompt created by DOS. Try it both ways to see what we mean.

You have told the computer to copy what you have written on the console (COPY CON:) into the filename that you specified. You can use this procedure when creating any text file and its great for making quick changes. If you do not have the ANSI.SYS file on the root directory of your DOS disk then copy it there so that it can be found when DOS is booting the computer. ANSI.SYS is a program included with all versions of DOS. A updated version of the ANSI.SYS program is on the PCjr POWER disks under the name ZANSI.SYS.

For the new CONFIG.SYS file to become active you must reboot the machine - (CNTL) (ALT) (DEL).

Lets suppose that you have extra memory in your Junior and you also want to be able to use a RAM disk and work with some larger programs that can use a lot of files simultaneously. The CONFIG.SYS file for this example may look similar to this;

```
A>COPY CON:CONFIG.SYS
FILES = 20
DEVICE = ZANSI.SYS
DEVICE = CONFIGJR.NRD -C -K -T3
DEVICE = RAM.SYS ^Z
```

1 file copied

Of course, you should copy the files ZANSI.SYS, CONFIGJR.NRD and RAM.SYS into the root directory of the DOS disk. Then you must reboot. This CONFIG.SYS sets the computer to have 20 files open at a time (FILES = 20), turns on the extended keyboard and display control (ZANSI.SYS), causes the Junior to enter the 80 column mode and to recognize memory above 128K (CONFIGJR.NRD) with the capital letters (-C) and keyclick (-K) modes turned on, and finally it allows the user the ability to create a RAM disk at any time (RAM.SYS). When the CONFIG.SYS is used in this manner it is called setting up the computers "ENVIRONMENT" and it is very useful in creating the proper work area for your programs. NOTE the device drivers CONFIGJR.NRD and RAM.SYS are on the PCjr POWER disks with instructions.

Device drivers exist for all types of software and hardware like a mouse, some modems, extra drives and memory expansions and they will allow your PCjr to work with a majority of these peripheral items.

The second file of importance is the AUTOEXEC.BAT. DOS treats the AUTOEXEC.BAT as though you were actually giving the commands from the keyboard. After DOS has located and utilized the files in the CONFIG.SYS, if the AUTOEXEC.BAT is found, DOS will follow the commands listed here also. If there is a AUTOEXEC.BAT the date and time function are bypassed unless you give the commands DATE and TIME within the AUTOEXEC file.

When you boot the PCjr with DOS it will normally come to the A> prompt in the 40 column mode. This mode is incorrect for most business software to utilize. We can have the AUTOEXEC.BAT file place the computer into the 80 column mode automatically as the system boots up like this;

```
A>COPY CON:AUTOEXEC.BAT <ENTER>
MODE CO80 ^Z <ENTER>
```

1 file copied

Remember that MODE is an external DOS command so the MODE file must be in the root directory of the DOS disk. Now when you reboot your computer DOS will find and execute the CONFIG.SYS file and then it will find and execute the commands in the AUTOEXEC.BAT file. The screen will be placed in the 80 column mode. Suppose we also wanted the date and time prompts back, we could create our AUTOEXEC file like this;

```
COPY CON:AUTOEXEC.BAT
MODE CO80 (MODE 80 for mono monitor)
DATE
TIME
CLS ^Z
```

1 file copied

This time you will go into the 80 column mode and then be prompted to enter the correct date and time. Then the screen will clear and the A> prompt will appear. If you had wished to add the commands to start a program or to change default drives or any customization that will make your work easier they all can be put into your AUTOEXEC.BAT file. Practicing with the AUTOEXEC.BAT file can eliminate a lot of duplicate typing that you would have to do after the system boots each time.

Here is an example of the CONFIG.SYS and AUTOEXEC.BAT used to set up a computer with color monitor in the 80 column mode with 640K of memory, 2 disk drives a 100K area set aside for RAM disk, set the date and time to the internal clock/calendar, and the printing blue letters on a black screen with the copy verify parameter turned on;

The CONFIG.SYS file

```
FILES = 15
BREAK = ON
DEVICE = CONFIGJR.NRD -C -D2 -K -T3
DEVICE = READCLK.SYS (set clock/calendar)
DEVICE = RAM.SYS ^Z (RAM disk driver)
```

The AUTOEXEC.BAT file

```
SETRAM C 100 (sets a 100K RAM disk)
PROMPT $e[34;40;1m (turns screen blue on black)
PROMPT (bring back the prompt)
VERIFY ON (verifies copied file info)
CLS ^Z
```

The PROMPT commands are examples of the extended keyboard commands that can be used when the ZANSI.SYS device driver is used in the CONFIG.SYS file.

You can study these two files further in your DOS manual for further information on their use.

SETTING UP THE COMMAND INTERPRETER

COMMAND.COM is the file needed by DOS for DOS to remain resident in the computers memory. Some programs use a portion of the space occupied by COMMAND.COM. When these programs end DOS will look to reinstall COMMAND.COM. If your DOS disk is not in the disk drive you will get the message;

"Place COMMAND.COM in drive A and press any key"

On your PCjr Power disks there is a program named COMSPEC.COM COMSPEC tells DOS where to find COMMAND.COM. You can place COMMAND.COM on any drive or in any directory, all you must do is tell DOS where COMMAND.COM can be found.

If you are using a computer with memory of 256K or more you can assign a RAMDISK, move COMMAND.COM to the RAMDISK (Drive C:) Remember that a ramdisk uses RAM memory to act like a disk drive within the memory.

From the PCjr Power diskettes you will discover three files that allow you to easily setup a RAMDISK. 1. RAM.SYS, 2.SETRAM.EXE, and 3. RAM.DOC. RAM.DOC is the documentation for using the other two files.

Let's make a new DOS boot disk to allow us to use the RAMDISK at the onset. First format a new diskette with the DOS system files on it, ie:

```
A.FORMAT B:/S (enter)
```

Then copy these files from your DOS diskette to the new boot disk. FORMAT.COM, DISKCOPY.COM, MODE.COM, EDLIN.COM and ANSI.SYS. From the PCjr Power diskettes copy these files to your new disk, COMSPEC.COM, RAM.SYS and SETRAM.EXE.

Now place your new diskette into drive A, and we will setup the CONFIG.SYS file to establish the computer environment;

```
A>COPY CON:CONFIG.SYS (enter)
FILES = 10 (enter)
BUFFERS = 20 (enter)
BREAK = ON (enter)
DEVICE = ANSI.SYS (enter)
DEVICE = RAM.SYS (FN6) (enter)
```

We have created the CONFIG.SYS file that allows us to make a RAMDISK. Now we will create a AUTOEXEC.BAT file that will do the main work for us;

```
A>COPY CON:AUTOEXEC.BAT (enter)
CLS (enter)
MODE CO80 (enter)
SETRAM C 90 (enter) *starts a 90K ramdisk*
PATH=A:\;C:\ (enter)
SET COMSPEC=C:\COMMAND.COM (enter)
COMSPEC=C:\COMMAND.COM (enter) ( in DOS 2.1 only)
COPY COMMAND.COM C: (enter)
COPY EDLIN.COM C: (enter)
COPY DISKCOPY.COM C: (enter)
COPY FORMAT.COM C: (FN 6) (enter)
```

Remember to have copied all of the files you call-up in the AUTOEXEC.BAT to the DOS disk. Now when you want to use diskcopy, format or edlin your computer can find it without having the DOS disk in drive A. COMMAND.COM can also be found without having to reinsert the DOS disk in the drive.

DOS 2.1 requires a second COMSPEC=C:\COMMAND.COM line in the file to complete the assignment as in line 5 of the file above. DOS 3.0 and greater do not need the additional line.

NOTE: The PCjr Power diskettes contain the program CONFIGJR.DSK, which can be used to start a RAMDISK. Please read the instructions for using this program.

USING DOS 3.2 AND 3.3 WITH THE PCjr

DOS 3.2 and 3.3 offer some additional commands that make them much more complete than their earlier versions. Both offer the ability to use two different type drives within the same environment. DOS 3.2 and 3.3 assume that the drives are 3.5" 720K at default.

Under DOS 3.2 you can cause the system to recognize almost any type of drive that you install into the system. Let's say you wanted to use two physical drives, drive A is a 5.25", 360K internal drive and you have added a 3.5", 720K external drive to the system.

The command **DRIVPARM** is internal for DOS 3.2 and it should be called in your CONFIG.SYS file to indicate your drive structure. From this example we would add these command lines to the config.sys file;

```
DRIVPARM=/D:0/F:0/T:40 (drive A=5.25" - 360K)
DRIVPARM=/D:1/F:2/T:80 (drive B=3.5" - 720K)
```

The switches involved are as follows,

```
D: equals drive number where 0=A, 1=B, etc.
F: equals the drive type where 0=5.25"-360K, 1=5.25"-1.2M, and 2=3.5"-720K
S: equals the number of sectors per track-default is 9
T: equals the number of tracks per side-default is 80
```

The use of DRIVPARM allows the correct formatting of drives A and B. NOTE: DOS 3.2 has no provisions for the larger capacity 3.5" 1.44M drives. Some DOS versions do not use DRIVPARM and have only the DRIVER.SYS command as below.

Under DOS 3.3 the command is changed and allows wider parameters to be used. The command for drive selection here is **DRIVER.SYS** and it is a external command. This command sets up each physical drive as two logical drives. This means that drive A is also drive D, and drive B is also drive E. DOS skips the normal drive designator used for a hard drive, which is C:, even with no hard drive is installed. If you had two hard drives installed the C and D designators would be passed over and drive A and E would be the same and drive B and F the same. The added command lines in the config.sys file, for the above example, would be;

```
DRIVER.SYS=/D:0/T:40/F:0 (drive A-D 5.25"-360K)
DRIVER.SYS=/D:1/T:80/F:2 (drive B-E 3.5"-720K)
```

Again the D: switch indicates the drive letter, the T: switch indicates the number of tracks and the F: indicates the drive type. In addition to the listings above for the F: switch, under 3.3 the number 7 = 3.5" - 1.44M drive.

With 3.3 you must format the higher logical drive to produce the proper formatted disk. For drive A you would format drive D(E). For drive B you would format drive E(F). This means that you can also copy between the logical drive letters. To copy a file from drive B to another 3.5" floppy disk you would type;

```
B>COPY filename.ext E: (enter)
```

and DOS 3.3 will prompt you to change diskettes in drive B as though it were two 3.5" - 720K drives.

If you are using either 3.2 or 3.3 with your junior, you may experience noisy drive activity. If this problem appears use the HUSH program from the PCjr POWER disks in your autoexec.bat file to quiet your drives.

REPLACING DISK DRIVES IN THE PCjr

The majority of disk drives in the PCjr at present are Qume 142's. This is a belt driven drive with a fairly high failure rate.

Replacing this drive is not difficult as long as the power and drive cable connections are accessible to the internal cables when the new drive is installed into the bracket that holds it in the junior. One drive that we recommend is the Fujitsu 2551 direct drive because of their high quality and because no internal modification is needed to use it as a replacement.

Turn the power off and unplug the computer from the 110 volt source. Remove the top of the junior. The disk drive is in a bracket that is held in the junior by two snap in feet that pass through the mother board and into the case bottom. Remove the wide grey cable at the rear of the drive and grasp the drive underneath of the bracket in the rear. Lift up on the rear of the drive and bracket and the two feet will snap out. This procedure is covered in your PCjr Guide to Operations. If the drive has not been taken out before it may be stiff to snap out the first time.

With the drive set outside the junior remove the 4 hex head screws holding the drive into the bracket and remove the power cable from the rear of the drive. There are 4 filler pieces that were located between the bracket side and the drive at the screw holes to give support to the bracket. They will drop out as you remove the old drive and probably will not be needed again.

Set the new drive in place and check to make sure you can connect the power cable around the fan. Install the 4 mounting screws loosely. Set the bracket back into the junior and align the drive faceplate into the front slot. Tighten the left front mounting screw to hold the drive in place. Remove the bracket again and tighten the remaining screws.

On the new drive move the drive select jumper to drive "B" position for a single disk drive or to the drive "A" position for a dual drive setup. The RESISTOR PACK or terminating resistor must be removed. Reinsert the drive with bracket into the Junior. Watch that the power and fan wires do not get caught under the rear feet. Reattach the wide grey cable with the 45 degree fold bringing the red edge to the right rear of this connector. Install the top and your cabling and you are ready to use the new disk drive.

256K DRAM CHIP USING AND HANDLING

There are many types of 256K DRAM chips that will work on the junior memory expansions. All should be CAS before RAS refresh and at least 150 ns in speed. Anything faster than 120 ns is probably a waste of money speed wise on the junior.

The following is a list of compatible DRAMs by manufacturer;

NEC	41256 (must be 1987 date or later)
Texas Inst.	TMS4256
Samsung	KM41245 or KM41256A
Hitachi	HM50256
Intel, Fujitsu and Mitsubishi	

AVOID Toshiba, Motorola, OKI, Micron Tech. (MT), Western Electric (WE), Seimens and NEC dated 1986 and earlier.

Static handling of 256K chips is very important and these chips are subject to destruction by static shock. Some tips follow that should make use of the chips easier.

- A. Handle the chips as little as possible. Leave them in their static shield cases until ready to install.
- B. Use a clean work area with plenty of light.
- C. **SHUT OFF AND UNPLUG** any equipment you are adding these chips to.
- D. When you remove the chips from the static tubes make sure they are facing in the direction so you will not have to turn them around before you insert them.
- E. If you have a grounding strap wear it.
- F. **KEEP YOUR FEET OFF OF THE FLOOR** when inserting the chips.
- G. Handle chips by the ends whenever possible.
- H. Check chip orientation before applying power to the device. Reversed chips will auto-destruct on power up.

256K REPLACEMENT CHIP DIAGRAM REPLACE 64K CHIPS

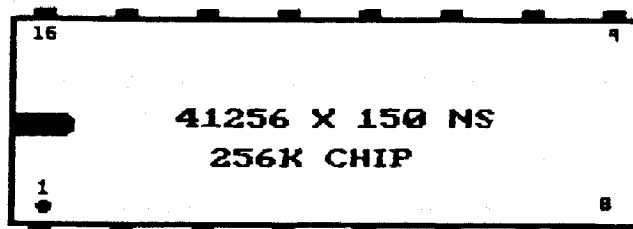

A CURE FOR SMEARING

Smearing is the phenomenon of everything on the juniors color screen appearing to be pulled or "SMEARED" sideways. This most frequently happens when you do a warm boot (CNTL ALT DEL) and your monitor circuitry has warmed throughly.

The problem can be eliminated by adjusting the horizontal hold located on the main circuit board of the monitor.

TOOLS NEEDED

- 1 Small philips screwdriver with insulated handle.
- 1 Medium philips screwdriver

REMEMBER: when working with live electronic circuits keep one hand in your pocket at all times. Use plenty of light.

1. Start with the power turned off but connected. Lay the monitor down on its face usually on some newspapers to protect it. Remove the eight screws that hold the back monitor cover on. 4 screws in the bottom, two in the top and one either side of the power connector.

2. Remove the back cover. Don't touch the circuitry because sometimes large voltage charges remain. Sight locate the adjustable capacitor labeled "H. Hold" located towards the center of the monitor circuit board.

3. Carefully slide the cover back in place and sit the monitor upright. Turn on the monitor and your junior and allow it to warm up. After 15-30 minutes, reboot your machine with a warm boot (CNTL ALT DEL). If it doesn't smear the first time give it some more time to warm up and do the warm boot again.

4. When you get the smeared screen, carefully slide the back cover off. Locate the H. Hold again. Holding the small philips screwdriver by the insulated handle only, adjust the H. Hold for normal picture. Remember one hand only, do not let the screwdriver shaft or any part of your hand touch the insides of the junior.

5. When the adjustment is made, turn off the power and carefully reinstall the back cover and all eight screws and you are ready to computer without the worry of smearing.

PCjr COMMUNICATION HINTS

The IBM PCjr posed some unique communication situations that users across the country have attempted to solve. We will discuss types of modems, communication ports, and downloading files.

MODEMS CHOICE

First of all let me say I would never use a 300 baud internal modem with the PCjr again. They were the cause of numerous hours of grief and frustration. You can select from a range of good 1200 or 2400 baud Hayes compatible external modem with 4 to 8 time the speed uploading and downloading files at very reasonable prices. The modems connect to the "S" port on the back of the Junior with a IBM Serial Adapter cable which is about 4" long and that, in turn, is connected to a standard modem cable. The modem is then plugged into power and into the telephone line and you are ready to begin. I have seen almost every standard Hayes compatible modem used with the Junior.

COMMUNICATION PORTS

The communication ports addresses are a confusing item for some people. The "S" port, on the rear of the Junior, is normally addressed as COM1. If you fill the internal modem slot with a modem or drive 2 controller or other item, then that becomes COM1 and the "S" port becomes COM2. According to the Tech Reference manual, COM ports on the Junior have a maximum 4800 baud rate. All of this should be kept in mind if you are setting up a external modem. Some communications programs will still not locate the correct COM port and a shareware program like SWAPCOM (PCjr Power Disk) can be used to correctly identify COM2. The "S" port is also the place where the PCjr Thermal Printer or a Mouse connects. Some people have added a switch box to control both items while others simply unplug their mouse when using the modem.

SERIAL PRINTER WITH COM PORT

When setting up a serial printer to run from the communications port you must give the following commands at the DOS prompt or include them in your AUTOEXEC.BAT file so that they install automatically.

```
A:>MODE COM1:1200,N,8,1,P
A:>MODE LPT1:=COM1
```

Remember that MODE is a external DOS command and that program must be on your boot disk when called in the AUTOEXEC.BAT file.

DOWNLOADING/UPLOADING FILES

Most of the popular software has many upload/download protocols and they are most efficient in transferring files. The junior processor, (8088) without the availability of DMA (direct memory access) cannot do other tasks when doing a drive read or write. For this reason, some of the download material may be lost while the machine is writing information to the disk drive. In order to get around this, I suggest RAM memory large enough to run your communications software and to establish a minimum a 150K RAM disk. Download all your files into the RAM disk area because this is very fast and no time is lost to the movement of drive heads. When you are done with the download you can SHELL to DOS or sign-off and copy your files to a physical floppy at that time. This means that when you set up your communications program the default download drive should be drive C or whatever letter you have assigned to your RAM disk. I believe the best possible setup for doing a lot of communications work is 640K of RAM memory with 360K set aside as RAM disk and a good communications software package. Some of the best shareware communication programs are PROCMM, BOYAN, and Q-MODEM, but there are many fine commercial programs as well.

CALL WAITING

When using a modem program and you have the call waiting feature assigned to your line, you must disable this feature in order to have uninterrupted communications. To disable the call waiting feature place a *70 after the ATTENTION DIAL command and before each telephone number in the dialing directory like this;

ATDT *70 telephone number, (ATDP 1170) rotary phones.

The *70 (1170) command must be issued before each call as call waiting is reestablished after each call is complete.

RUNNING PROCMM WITH THE INTERNAL MODEM

Setting up PROCMM to run with the internal modem is tricky and you must get into the MODEM SETUP screen and add the commands as follows;

- 1) Modem init string ^NF 4!
- 2) Dialing command ^NT 0,D . ("0" = a zero)
- 3) Dialing cmd suffix ... !

- 9) Hangup string ^NH!

Be sure to use these strings exactly as shown. The spaces after ^NF, ^NT and 0,D are important. These strings are used in CAPS. When complete press (ESC) and (S) to save the setup menu.

If PROCMM is having trouble recognizing the correct COM port run the "SWAPCOM" program before running PROCMM. Then have PROCMM address COM2.

A CURE FOR NOISY PCjr DRIVES

If your disk drive is noisy, making a grinding, screeching and laboring sound. This could indicate a problem that is just the tip of the iceberg. If this problem persists it will create wear on the head carriage and rods that will eventually cause bad head alignment. This problem often begins by giving erratic read errors on boot up or in doing disk read chores.

The problem is that the drive head carriage is sticking on the rails as it travels back and forth accessing the different tracks on the diskette. The grinding sounds come from the head mechanism vibrating as the stepper motor pushes it along rails which CONTAIN little or no lubrication.

You can lubricate the drive yourself if you are careful and look at the parts before you attempt to do the job.

Use good light for this job. Unplug the computer from the power source. Remove the top of the Junior and set it aside. You can locate the head carriage mechanism by looking down from the top of the drive into the center. (see diagram) The heads usually have a coil spring which assist them in closing when the drive arm is turned down onto a diskette. You can move these heads back and forth yourself but don't touch the actual read/write head. The drive carriage rides on two 1/4" shiny metal rails. We need to lubricate the area where the carriage feet ride on the metal rails.

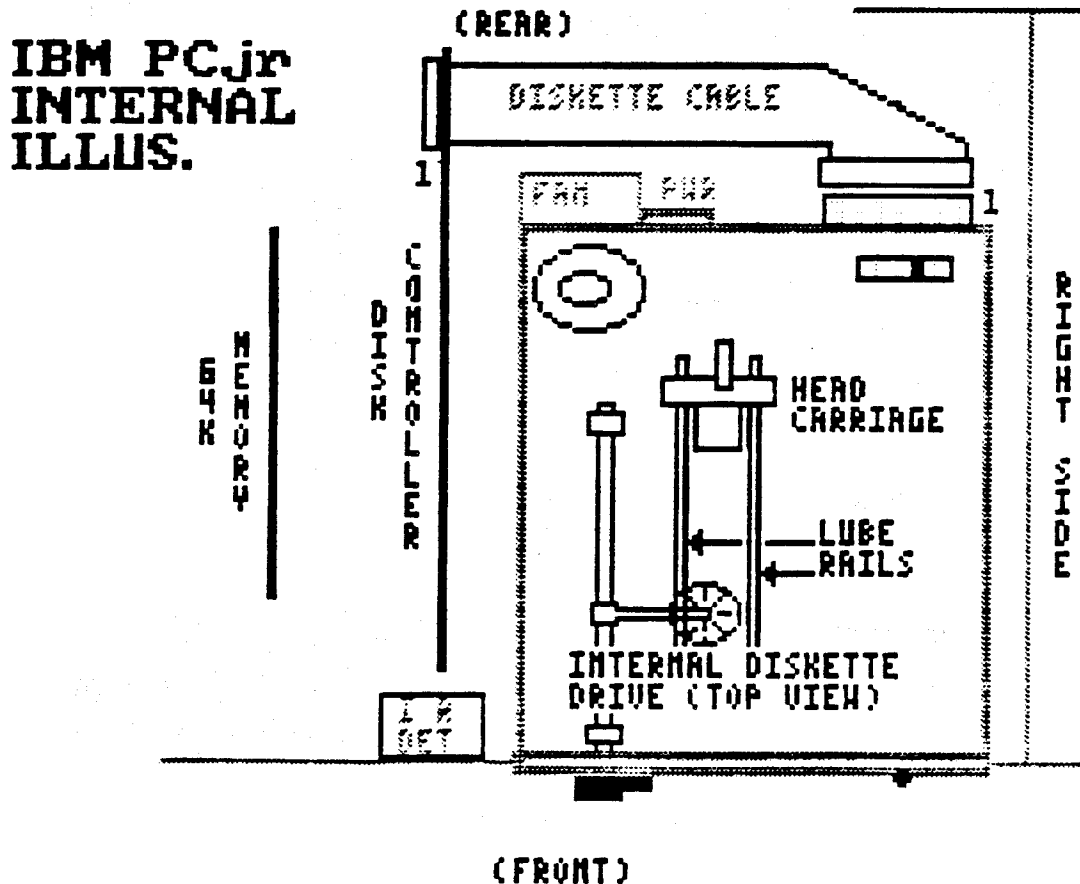

I suggest a very light model railroad or sewing machine oil used with a small pinpoint oiler. Radio Shack makes a small pencil (percision) oiler that is ideal for this purpose. These oil types are not corrosive to the plastic in the head carriage. With the head carriage all the way to the rear of the drive, place a very small amount of oil on each rail just ahead of each of the head carriage feet. Move the carriage manually back and forth through the oil to spread it along the rails. That's all there is to it.

Do not use cotton swabs or other lint producing material in an attempt to lubricate the rails as they will give off a fiber that can cause a binding problem when the head carriage is moving. Now when you boot up you will notice a smoother, quieter, more fluid sound to your drive and the lubricating can prolong the useful drive life by as much as 1/3. This lubrication should be done about once every 12 months.

CLEANING THE PCjr DISK DRIVE

There are many kits available that state they will clean the diskette drive heads(\$5 to \$30). First let me say that it is somewhat rare to have to clean the drive heads. Usually you will begin to notice frequent read errors when attempting to access the drive. The drive should be checked for lubrication first, and then you can clean the read/write heads.

The head cleaning operation should be carried out only with a MOIST disk head cleaning kit and the cleaning should be done only briefly. Moisten the diskette head cleaner and insert it into the drive. Type "DIR" and hit enter. This lets the drive spin briefly and clean the heads. Remove the head cleaner and place it aside. Your heads should be as clean as they need to be. I do not recommend this process be done more than once yearly for very heavy users and every 18 to 24 months for most casual users and then only if the symptoms appear.

Abrasives cause unneeded head wear and normally disk drives do not require cleaning. On the other hand, some of the cheaper diskettes on the market today will give up media more easily and can cause the drive heads to become impaired. Then cleaning may be necessary. **NEVER TOUCH** the disk drive heads with your fingers and never poke around at them with tools, this can ruin your drive immediately.

TECMAR MEMORY EXPANSION ERROR

Many Tecmar 128K or modified 512K memory sidcars sometime begin to experience a intermittent problem that appears on boot-up. An "ERROR A" will sometime, not always, be reported after the 128K count.

This problem is usually associated with the 5 volt power supply falling to low voltage. There is a 3 pin 7805 voltage regulator plugged into a socket on the main circuit board inside of the case and it is secured with a screw to aluminum heat sink.

You can replace this voltage regulator for about \$1.95 at Radio Shack. When reinstalling it, there should be plenty of the white thermal conductive compound used. This is also a Radio Shack item. Just make sure to install the voltage regulator exactly as the old one was removed.

If you do not provide good ventilation the regulator could fail again in about a year due to the heavy thermal activity, but it is easily changed and should cause no related problems to the circuit board components.

DAMAGED REAR CONNECTORS ON THE PCjr

Due to the makeup of the JJKLPT and DSC connectors on the rear of the computer, they can be easily damaged. The pins can be bent or broken off. We have found that repair of these connectors is fairly easy. First locate the connector with the broken pin. Unplug the Junior and remove all internal parts including, power supply, 64K memory card, disk drive, controller card, and modem. We remove the mother board from the PCjr shell for easier access to the connectors.

With small side cutters locate the broken pin from the inside and cut it off 1/4" above the mother board. With small needle nose pliers pull the remaining piece of the pin out of the connector. Locate a unused connector like the "L" or "C" port and snip one pin lose at the surface of the board. Pull this new pin out and push it into the connector hole that needs a new pin. Align the new pin with the remaining 1/4" segment of the old and solder them together. This substitution works well generally, however, on some occasions I have swapped the complete pin by unsoldering it from the system board and bending it up slightly to remove it.

STATIC/ERRANT ELECTRICAL CHARGES

Many people do not realize the destructive power of static or errant electrical charges. They have damaged their machines extensively because TO LITTLE PRECAUTION was taken against these charges.

1. When working inside the Junior always unplug the power supply. Wear a wrist grounding strap if possible, or sit with your feet raised above the floor to avoid potential arc's from you to the internal computer parts. (I put my feet up on the wooden rungs of my chair).

2. When transporting your computer on cool days; remember to allow adequate time to it warm and evaporate internally formed condensation before restarting it. Water droplets form on the contact surfaces where the boards plug into the connectors. An the electrical potential can damage many areas of computer if there is moisture present between the pins.

3. If you live in an area where static build-up becomes a problem during fall and winter. Try to have your computer set up in an area available to a humidified air to reduce the static shock hazard.

SPEEDING UP YOUR JUNIOR

So you think your Junior is slow getting the job done? You come home from work, having worked on a XT or AT all day and the Junior just drags things out.

Here are some things that will help your Junior to compete with the big boys when it comes to getting the job done. The prices listed in here are approximate. The first item is additional memory, we recommend the minimum of 256K additional RAM bringing your computer to 384K around \$165.00, but if you have the money add the full 512K to get your computer to 640K at about \$255.00. With the added memory you computer will run faster when the programs are loaded into the higher memory. You can also use a RAM disk which will speed up programs that must go to the disk drive often. Normally memory expansion software will contain the software needed to create a RAM disk.

You can also add a V-20 chip (\$15.00) which will give speed increases from 7-40% depending on the operation. You can add this chip at the same time that you add memory or anytime that you choose.

There is the Nickel Express JR Turboard (\$80.00) which will give you two speed selections, 4.8 or 8 mhz. Many clone computers are speed selectable and the ability to slow down for some games and speed up for your word processing/database work is a big help. There is also a 8087 co-processor board (\$200.00 board and chip) which will aid in speeding up the math processing taking place in the computer.

Some of the new plug in cartridges, like the PCjr Video Cartridge, the Quicksilver Cartridge and the PC ID Cartridges (\$30-\$60) will all give a speed increase to an individual machine function.

One of the items that I like is the new Synectics Software Keyboard adapter (\$46.00 alone, \$120.00 with keyboard) which allows the use of a standard 84 or 101 key keyboards. This speeds up your work by allowing single keystroke function key input and if you use one of these standard keyboards during the day you don't have to readjust to a different keyboard at home.

You can also add a second physical floppy drive in either the 5.25" or 3.5" format (\$200.00 to \$250.00). These make the tedious jobs of copying files, doing diskcopies, formatting disks, and running programs requiring 2 drives infinitely faster. The last item is a hard disk drive addition(\$600.00 to \$900.00), which gives very fast access to programs and files, sorting speed is greatly increased also. This addition is very expensive but if you use your Junior a great deal or if you are running a business on it, the hard drive may be well worth this amount of money.

HARDWARE SOURCES

The above items are available from many different distributors, this is a list of some of them along with the items that they carry;

OWL SOFTWARE (Free Catalog Available)
1435 Burnley Sq N.
Columbus, Ohio 43229 (800) 322-0219 11am to 6pm EST

Memory Expansions, 2nd Floppy Drives, V-20 chips, Dual Font Chips, Quicksilver Cartridges, Keyboard Adapters and more hardware. The home of PCjr POWER.

E.S. Quality Products
767-B Redwood Place
Reno, Nv 89502 (702) 786-4040

Memory Expansions, Drive Controllers, Parallel Printer Ports, and Speedup Boards.

Paul Rau Consulting
260 N. Lincoln Way N.
Galt, Ca 95632 (209) 745-9284 9am to 4pm PST

Memory Expansions, Floppy and Hard Drives, Nickel Express Boards.

Computer Reset
P.O. Box 46182
Garland, Tx 75046 (214) 276-8072

Memory Expansions, 2nd Floppy Drives, V-20 chips.

Systems Peripherals Consultants
9747 Business Park Avenue
San Diego, Ca 92131 (800) 345-0824

10 and 20 Meg Hard Drives for the Junior.

PCjr NEWSLETTER AVAILABLE

Here it is, a complete newsletter for junior lovers. Published monthly for the subscription price of \$19.00 per year. Make your check payable and send it to-

jr NEWSLETTER
BOX 163
SOUTHBURY, CT 06488

NOTES:

MODIFYING THE IBM 128K SIDECAR FOR 736K APPLICATIONS

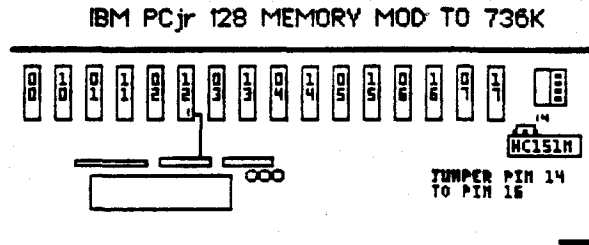

With the number of memory additions on the market it is possible to address up to 736K of RAM memory with the Junior and 640K either on a JrHotshot, Techmar, IBM or Microsoft units, and an additional 128K memory sidecar. You can use a number of different sidecars to achieve the additional memory but the IBM sidecar requires a hardware modification to allow the use of the memory above 640K limit.

** Even though the junior can address 736K of memory, many programs cannot use this addition and, in fact, are confused by the removal of the upper end memory limit. These programs, which include Lotus, Quicken, and Symphony, will not run when the junior is configured in this manner. If you find a package is not running when you junior is configured with the "-L" option try turning off this switch and begin the program again.

Remove the memory sidecar from the computer. Remove the four mounting screws and open the case. Lay the board down as shown in the illustration, with the component side up and the switches to the upper right. Turn all of the switches OFF. Locate the 16 pin DIP IC package (74HC151N) which is directly below the switch bank. Locate pin 14 (illustration) and either carefully unsolder or snip this pin away from the board. Raise the pin up and with a short wire, jumper pin 14 to pin 16 of the same chip. Again make sure the switches are OFF.

If not already installed, install the memory needed to take the computer to 640K and test it. Then attach the sidecar and use the CONFIGJR.SYS file from the PCjr POWER diskette with "-L" option to recognize memory to a full 736K. If memory checks out OK, you can return the board to it's case and reattach it to the Junior.

NOTE - one item of caution here, if you are using a JrHotshot memory expansion, a parallel printer port and have made the Tandy modification, adding this modified 128K sidecar could tax your internal power board to the limit. This can cause the power board to fail.

ADDING A RESET BUTTON TO THE JUNIOR

You can add what IBM left out, a RESET BUTTON on the front of the Junior to help you out when (CNTL-ALT-DEL) won't break you out of the program. This addition is fast, efficient and very easy to add.

MATERIALS NEEDED

- 1 Momentary push button SPST switch, normally opened.
- 2 24" pieces of 20 gauge wire

TOOLS NEEDED

- 1 Soldering iron - LOW WATTAGE
- 1 Needle nose pliers
- 1 Diagonal cutters
- 1 Small screwdriver
- 1 Drill and Bit
- Solder Fine, rosin core

GETTING STARTED

Start by shutting off power to the Junior and disconnecting all cables from 110 volts and the Junior. Remove the top cover, and disconnect the ribbon cable from the disk drive. Remove the controller card and disk drive and set both aside.

Next find a suitable area on the front panel for your reset switch and carefully drill a hole the size required to fit the switch. Be careful that the location does not interfere with any of the internal, upright cards. Solder the two #20 wires to the switch and mount the switch into the hole securely. Twist the wires together to form a single strand.

You can use the infra-red receiving hole to mount the switch if you choose, but there are a lot of new modifications that fall into that area and it could get crowded.

Position the computer so that the rear is facing you and route the wires to this area. Locate the 8284 chip in the lower left corner nearest to you. (see diagram) Below this chip you will see three resistors (R1, R2 and R3). R1 and R2 have the same colors, green, brown, brown, a value of 510 ohms. The rearmost end of this pair of resistors is connected to each other. Solder one wire at this connection of the resistors.

Next, locate the capacitor (C1) to the right of the 8284 chip. The leg of the capacitor that faces the front of the computer should be marked with a stripe and is the negative (-) leg. The remaining leg of the capacitor should be facing the rear of the computer and is the positive (+) leg. Solder the remaining wire to the POSITIVE leg.

Reinstall your disk drive, controller and the associated ribbon cable. Orient and route all wires and cables correctly and install the cover.

To test this modification, boot up your computer. At the A> prompt press the RESET button and your computer should re-boot just as if you were doing a warm boot. (CNTL-ALT-DEL)

IBM PCjr RESET BUTTON ILLUSTRATION FRONT

DISK DRIVE REMOVED

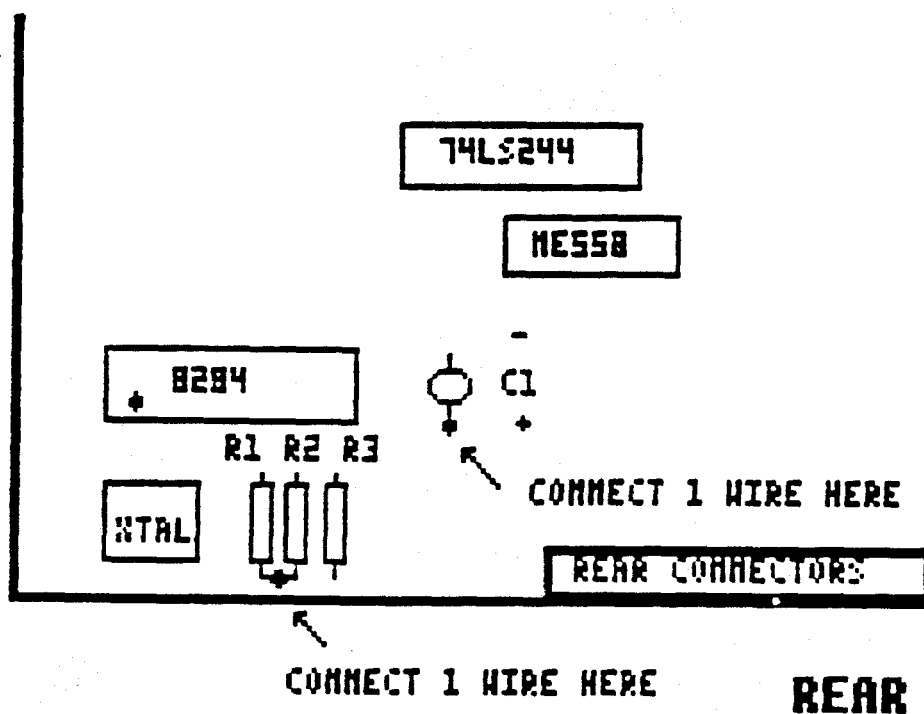

PCjr TO TANDY 1000 MODIFICATION

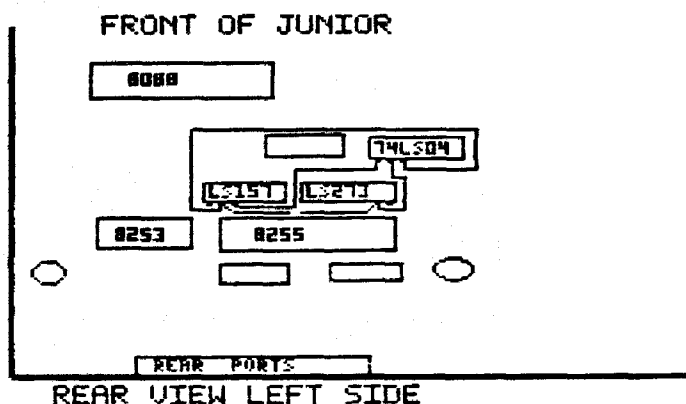

DISKETTE DRIVE REMOVED AND SET ASIDE. FACE YOUR COMPUTER FROM THE REAR.

Piggy back the 74S86 on top of the 74LS04 (ZM33). Solder pins 7 and 14 of the 74S86 to the 74LS04. Bend up all other pins of the 74S86 and solder to pins 1, 2 and 3 only.

This modification will allow the use of the Tandy 1000 16 color mode on the PCjr.

MATERIALS NEEDED

- | | |
|--------|-------------------------------|
| 1 | 74S86 14 pin chip |
| 1 | Low Wattage soldering iron |
| 12" | #28 or #30 tinned copper wire |
| 1 | Wire strippers |
| 1 | Diagonal cutters |
| 1 | X-acto knife |
| Solder | Fine, rosin core |

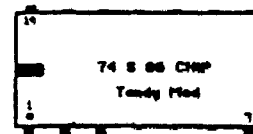

Start by cutting the trace on the COMPONENT SIDE of the board that runs from pin 2 of the 74LS157 to pin 9 of the 74LS273.

Bend up all pins on the 74S86 chip except pin 7 and 14. Properly align, with pin 1 over pin 1, the 74S86 over the 74LS04 and solder pins 7 and 14 to pin 7 and 14 of the 74LS04.

Consult the diagram and add these three wires;

- 1) pin 3 of the 74LS157 to pin 1 74S86
- 2) pin 9 of the 74LS273 to pin 2 74S86
- 3) pin 2 of the 74LS157 to pin 3 74S86

Use a 32K video buffer in your config.sys file. Specify either PCJRMEM /C or /E. If you use JRCONFIG, use the V32 switch and S1.

Remember to solder to the chip legs not the board traces. This modification will allow you to run Deskmate Deluxe Paint 2, Flight Simulator 3 using the Tandy option. In general, any program which exhibits horizontal black stripes before this change will now run properly.

ADDING A SECOND DISK DRIVE TO THE JUNIOR

You can add a second disk drive to the PCjr very easily. Just modify your controller card and make your cable for two drives also as per the instructions in this manual

PARTS NEEDED

- 1 Full or half height, double sided disk drive.
Most IBM drives will work fine.
- 1 Case with Power Supply. Standard full or half height case with its own power supply.
- 1 Modified DOS to run two disk drives
- 1 2 Drive cable

To make a new DOS diskette that will run two disk drives, format a diskette with the /S option. Create or modify a CONFIG.SYS file and add the JRCONFIG device driver found on the PCjr POWER DISKETTES. Denote the "d2" switch option for two disk drives.

Prepare the new drive. Move the drive select jumper to the drive "B" position and remove the resistor pack if one was installed. (see diagram)

Install the drive into the case and attach the 2 drive cable that you made to the drive connector. Make sure that pin 1 of the cable and pin 1 of the connector match up.

Inside of the Junior, move the drive select jumper on the internal drive to the drive "A" position. Attach the cable to the internal drive and then to the controller card. Insert the controller card into its buss connector on the mother board. Both drive motors will run with this modification but only one drive active light will be in use at any one time.

DEBUGGING

If you get a "ERROR H" at the POST, first check the drive select jumpers on both drives. The internal drive on drive "A" the external drive on drive "B".

Check the cable polarity at all three connection points.

Check the connector at the disk controller board to confirm that all pins from DCC are into the connector.

If both disk drives are running and have the active lights on at the same time the cable connection at the internal or external drive is reversed.

Check to make sure that the resistor pack is removed from the external drive.

DISK CONTROLLER CARD MODIFICATION FOR SECOND DISK DRIVE

Remember to carefully read all instruction for this change before beginning the actual work. DO NOT begin this modification unless you have your second disk drive and power supply on hand.

USE ONLY A LOW WATTAGE SOLDERING IRON. Please, if you do not understand the principles of soldering on printed circuit boards seek out knowledgeable assistance; such as a local users group, electronic technician or amateur radio operator (HAM) to help you with this facet of the modification.

GETTING STARTED

You will need the following parts to make this modification;

1	74LS175 16 pin chip
1	7410 14 pin chip (cut off pin 1)
1	14 pin socket (modified per below)
1	16 pin socket (modified per below)
1	34 conductor 2 drive cable
3.5 feet	#28 tinned copper wirewrap wire
1	Software diskette for 2 disk drives

You will need the following tools for this modification;

1	Wire strippers
1	Low wattage soldering iron
1	Desoldering tool or solder wick
1	Screwdriver
1	Neddle nosed pliers (small)
1	Diagonal cutters (small)
1	Soldering tool or dental pick
1	Magnifying glass
Solder	Fine wire, rosin core

It is important to have good lighting for this work. Shut off power to your PCjr and allow it to cool. Unplug the power cables form the wall sockets. Remove all cable connections from the rear of your junior. Using a flatblade screwdriver, pry up the top cover from the rear and remove it. Locate your disk drive controller board with the wide flat cable connecting it to the rear of the disk drive. Disconnect the cable from the disk drive and carefully lift out the controller board. Remove the flat cable from the controller board and set it aside. Place your controller board on a clean work surface with the component side up. The controller board should be oriented as in the enclosed controller diagram.

BOARD PREPARATIONS

Refer to the enclosed controller board diagram and locate pin 1 of the 3487P chip. Turn the board over and carefully locate pin 1 from this reverse side. With the desoldering tool (solder sucker) unsolder the pin. From the component side again, and with the solder tool carefully lift the pin away from the board and bend it up.

Next locate pin 13 of the 74LS04 chip. Turn the board over and unsolder this pin. From the component side, carefully lift this pin away from the board and bend it up. Pin 13 may be partially hidden by the electrolytic capacitor in this vicinity. If this capacitor hampers your reaching the work area, unsolder the end nearest pin 13 and lift it out of the way until this operation is complete. Then resolder this loose end back to the board.

Locate pin 10 of the disk controller cable connector (DCC). Looking at the component side of the board, it is the 5th pin from the right on the lower row of pins. (see diagram) With a marking pencil mark the location of this pin on the reverse (trace) side of the board for later identification.

Modify the chip sockets as follows, locate the pin 1 end (notch) of the 16 pin socket. Bend up pins 2,3,5,6 and 7 and cut off pins 10 through 15. This leaves pins 1,4,8,9 and 16 in their normal positions. Locate the pin 1 end of the 14 pin socket and bend up pins 3,4,5,6,8,9,10 and 11. Bend together pins 4 and 5 so they short together also bend together pins 9,10 and 11 so that they short together. Cut off pins 2,12 and 13. Leave pins 1,7 and 14 in their normal position. (see diagram)

Locate the 74LS08 chip on the board. With the soldering iron and solder, tin pins 1,7 and 14. Take the 14 pin socket provided and orient it over the 74LS08. The notched end of the socket over the notched end of the 74LS08. Solder the three socket pins (1,7 & 14) to the same chip pins below it. Tin the remaining bent up pins. SOLDER SHORT pins 4 and 5 and pins 9,10 and 11 together on this socket. (see diagram)

Locate the 74LS175 chip on the board. With the soldering iron and solder, tin pins 1,4,8,9 and 16. Orient the 16 pin socket over the 74LS175 as above and solder the socket pins (1,4,8,9 & 16) to the same chip pins below it. Tin the remaining bent up pins.

Before we proceed with the wiring lets check the board for good solder connections at the pins of the piggyback sockets. Use a magnifying glass and make sure there are no solder shorts to other chip pins. Check the reverse (trace) side of the board, making sure there are no solder shorts from your desoldering operations.

STARTING THE WIRING

Study the wiring schedule and the diagram to place the wires. Begin with pin 7 of the socket mounted on the 74LS175 and run a wire to pin 1 of the 3487P. Make sure that pins 4 and 5 and pins 9,10 and 11 of the socket mounted on the 74LS08 remain shorted together during the wiring operation. When connecting the wire from pin 8 of the socket at the 74LS08 to pin 10 of the DCC run the wire over the top of the controller card and to the solder trace for pin 10 on the reverse side of the board that you marked earlier. Keep this wire dressed neatly and close to the surface of the board.

When your wiring is complete, again check the board for good solder connections and solder shorts. Route and dress the wires neatly and place them down close to the surface of the board.

FINISHING UP

Install the chips into the piggyback sockets. The 7410 chip with pin 1 removed mounts over the 74LS08 chip with the pin 1 end nearest the notch. The 74LS175 mounts into the remaining socket. Pin 1, the notched end of the chip, over the notched end of the socket. Make sure all chip pins are fit into the socket holes.

Attach the new 2 drive cable to the modified controller card as the old cable was attached. (see diagram last page) Carefully reinsert the controller card into the main board and attach the 2 drive cable to the internal disk drive. Route the cable out of the right side of the junior through the notched area. Consult the last diagram and move the internal drive select jumper from the "B" to the "A" position. Replace the computer top being careful not to pinch the 2 drive cable.

Plug in the second disk drive power cable and turn it on at the switch. Plug in your PCjr components and insert your new SOFTWARE disk. Turn on your PCjr and boot-up.

DEBUGGING TIPS

If, when testing your drive modification you receive a **ERROR H** message at the opening diagnostic screen then you must check your modification in a **SYSTEMATIC** manner to help track down the error.

1. First check the disk drive select jumpers. Drive A (internal) should be in the "A" position. Drive B (external) should be in the "B" position.
2. Check the cable **POLARITY** at all three connection points. The controller card, drive A and drive B.
3. Check the addon chip **POLARITY** confirming that pin 1 of the add on is over pin 1 of the host chip.
4. Check all wiring connection. Look for solder shorts to other points, broken wires or wire connections or other problem areas.
5. If you use a second drive of your own, make sure the **RESISTOR PACK** was removed from this new drive.

If you received a **ERROR B** this indicates a keyboard problem.

1. Make sure your keyboard cable is plugged into the "K" slot at the rear of your junior.
2. If using batteries in your keyboard make sure they are good.
3. Check the alignment of the internal infra-red detector which may have been misaligned during the removal or installation of your controller card.

SECOND DISK DRIVE

IBM PCjr DISK CONTROLLER BOARD MODIFICATION

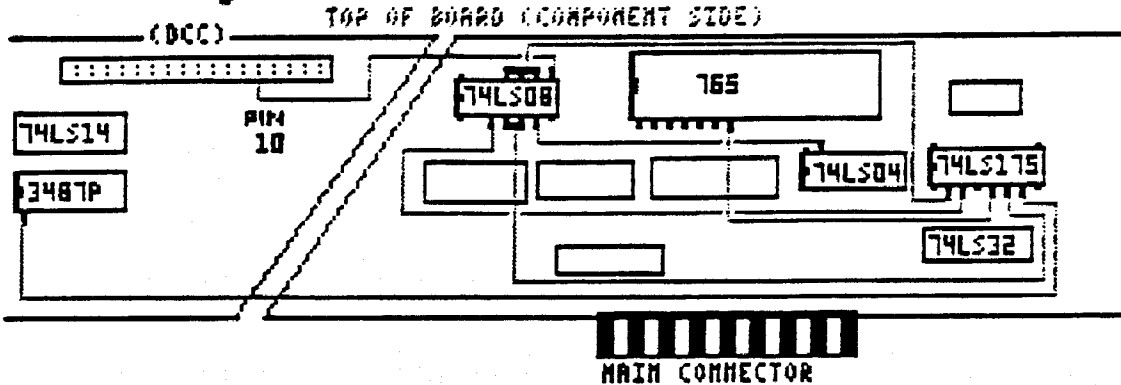

14 PIN



16 PIN

Sockets mount piggy-back on their host chips. The 14 pin socket on the 74LS08 chip. The 16 pin socket on the 74LS175 chip. **DO NOT INSTALL THE CHIPS UNTIL ALL SOLDERING IS COMPLETE.**

WIRING SCHEDULE FOR CONTROLLER MODIFICATION:

FROM	TO
74LS175 Pin 7	3487P Pin 1
74LS175 Pin 6	74LS08 Pins 4 & 5
74LS175 Pin 5	765 Pin 7
74LS175 Pin 3	74LS08 Pin 3
74LS175 Pin 2	74LS08 Pins 9,10 & 11
74LS08 Pin 8	DISK CONT. CABLE CONN. (DCC) Pin 10
74LS08 Pin 6	74LS04 Pin 13

NOTE: All wiring is done between the added piggy-back sockets or between the piggy-back socket and a existing location on the board. Pin 1 of the 3487P chip and pin 13 of the 74LS04 chip are isolated from the controller board by unsoldering and raising them up.

1. Move the Drive Select Jumper Bar of the internal disk drive, from position "B" one space to the RIGHT to the "A" position. (See the illustration)

2. When connecting the new 2nd drive cable, the colored edge wire should be NEAREST THE FRONT of the computer at the disk controller board connector. The colored edge wire should be to the RIGHT SIDE of the connector to the internal disk drive when installed. This cable should have two 45 degree bends in the cable near the internal disk drive connector. Route the cable out of the PCjr in the "notched" area molded into the right rear of the computer side. The top can be replaced without pinching the cable when it is routed in this manner.

3. Remember we are as near as the telephone and we are available to answer your questions about the installation. Our telephone number is (614) 436-0219 - 11 am TO 6 pm M - F. If you must leave a message we will get back with you as soon as possible.

NOTE: If you are adding a 2nd disk drive of your own, you must remove the internal resistor pack which is usually located near the cable connector on most popular drive makes. This need not be done with our addition.

**IBM PCjr
INTERNAL
ILLUS.**

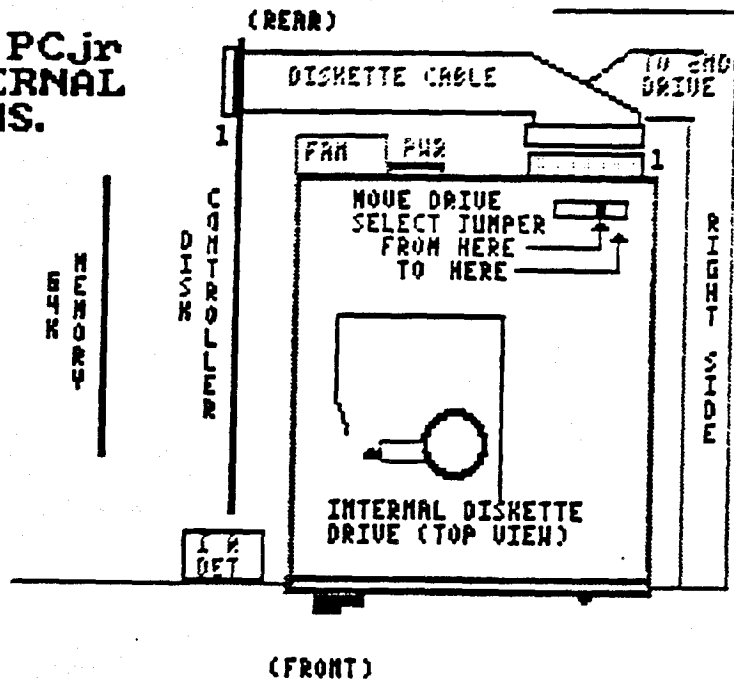

LOCATE AND MOVE THE DRIVE SELECT JUMPER AT THE REAR OF THE INTERNAL DISK DRIVE. MOVE IT FROM THE "B" TO THE "A" POSITION.

MAKING A SECOND DISK DRIVE CABLE

If you are modifying the disk controller card to run two disk drives you must make a cable to attach to the two drives.

PARTS NEEDED

1	34 pin ribbon cable socket IDS-34
2	34 pin ribbon cable edge card IDE-34
36"	34 conductor ribbon cable (36" is minimum)

TOOLS NEEDED

1	Aviation or tin snips
1	Vice with padded jaws

Make sure to cut the ribbon cable ends at right angles to the cable, use tin or aviation snips to make a good clean cut. Look at the three connectors closely and you will note pin 1 is usually marked by a arrow placed on the connector. The ribbon cable is marked on one edge with a color different than the color of the main cable usually a red or blue edge.

You can pad the jaws of a vice with a couple of strips of leather or other similar material, attached to the jaws with double backed tape. This will not allow the vice jaws to cut into the plastic connectors.

Install the socket connector end first, this is the connector that will attach to the controller card. Slide the ribbon cable through the connector placing pin 1 of the connector over the color edge of the cable. Line up the cable flush with the end of the connector and make sure that the connector is at right angles to the cable.(see your old cable) Press the two halves of the connector together forcing the pins into the cable. Holding the connector and cable slide the connector into the jaws of a padded vice. Slowly tighten the vice until the connector is seated. Do not overtighten the vice and cause damage to the connector. You can usually hear the connector snap together and no more tightening is needed at that time.

Now look at the old cable and note that the edge card connector is installed in the opposite direction from the socket connector. Lay the cable down with the socket connector positioned with the holes DOWN. Measure seven and a half inches from the socket connector end of the cable and install the first edge card connector contacts up and pin 1 to the colored edge of the cable. Follow the same procedure using the vice for the correct clamping of the connector to the cable.

The last connector is attached to the other end of the cable in the same direction as the first edge card connector. Again never fail to make sure that the cable and connector are at right angles and that you are careful in tightening the vice.

Look at how the original cable was folded and you can make that same 45 degree fold in the new cable near the internal disk drive connector. Make another 45 degree fold in the end going to the second disk drive.

IBM 128K MEMORY SIDECAR UPGRADE TO 512K

If you have a PCjr with a attached 128K memory sidecar you can upgrade that sidecar to house a full 512K of memory. Bringing your junior to full 640K.

WARNING: This modification is for people who are experienced in soldering and unsoldering on printed circuit boards.

PARTS NEEDED

16	256K DRAM BY 150 ns (see handling and type page)
16	Good 16 pin low profile sockets
7"	#28 or #30 tinned copper wire

TOOLS NEEDED

1	Small, good quality diagonal cutters
1	Low wattage soldering iron
1	Desoldering tool (Solder Sucker) and some solder wick
1	Small Screwdriver
1	Small pliers or hemostats
1	Soldering tool
1	Old toothbrush for cleaning
1	X-acto knife
Solder	Fine, rosin core

GETTING STARTED

Shut off power to your junior and remove the 128K sidecar. Completely remove the four mounting screws. Separate the sidecar halves at the pry points with a small screwdriver. There are eight catches holding the halves together, 4 top and 4 bottom. Remove the circuit board and lay it on a clean work area with plenty of light.

There appears to be three different versions of the IBM PCjr Memory sidecars. Two versions require no additional work but the third version requires you to cut one wire and solder in a extra wire.

VERSION 1 - looks very messy. There are many green wires covering the card. These wires are not the green traces that are part of the board but are extra wires that were added after the board was made. No extra work required.

VERSION 2 - looks neat. No extra wires and one of the positions for a chip was left empty. No extra work required.

VERSION 3 - looks clean. There is one green wire connecting pin 1 of the 64K chip to one of the resistor packs (the long, skinny yellow colored device with many pins in one row). There is also a position where a chip could go that is

empty. You will note one of the board traces has been cut. This board requires extra work. (see diagram) Remove this green wire completely by cutting it from the board with the diagonal cutters.

Using you small diagonal cutters completely cut all of the legs of the installed 64K DRAM chips. Do not attempt to save the 64K chips. Cut the legs closest to the chip, NOT to the board.

With a pair of needle nose pliers and your soldering iron, remove each cut leg from the board. Apply the heat from the soldering iron at the component side. Grip the leg to be removed with the pliers and remove each leg.

Remove all of the solder from the holes with soldering iron and desoldering tool (solder sucker). Some holes may require the use of the solder wick to draw up this solder.

Scan the board and cleaned holes for excess solder, loose chip legs or anything that is not apart of the board. Clean the board with a solder tool and brush the board with the toothbrush to be sure that you have cleaned it thoroughly. THIS IS MOST IMPORTANT as solder shorts become extremely hard to find once the sockets are installed.

Install the board back onto the side of the junior without its case, and turn the unit on. The power on self test (POST) should count to 128K as normal. Shut the unit off and remove the sidecar board and continue with the modification.

Orient the 16 sockets into the cleaned holes and solder them into the board.

If your card had the one green wire on it, add this extra step now. The trace that connects pin 1 of DRAM 1-2 to the 7th pin from the left of the second horizontal resistor pack from the left has been cut.(see diagram) You must reattach the two sides of this trace. Cut a length of the wire and insert it into the hole for pin 1 of DRAM 1-2 before you insert the socket and solder them both in at the same time. Run the other end to the 7th pin from the left of the second resistor pack from the left. You may place this wire on the component or trace side of the board.

With the component side of the board up (facing you) locate the set of three plated through holes to the right of the large chip (74S409 DRAM Controller) with a white rectangle drawn around them. This is a jumper which determines whether 64K or 256K chips are used. At present there is a foil trace on the component side which connects the left and center holes together. Completely cut this foil trace which connects the two holes with a X-acto knife. Then solder a jumper wire between the center hole and the right hole. See the diagram to locate this section.

FINISHING UP

Set all four DIP switches on the rear of the board to their "OPEN" position (on). It is advisable to place a piece of electrical tape over the 8 pin positions on the bottom of the board below the DIP switches to keep them from shorting to the case.

Carefully install the 16-256K chips into their sockets. Be sure each chip is oriented properly. Pin 1 pointing downward, just as the 64K chips you removed. (See section for handling and installing 256K chips)

Attach the sidecar board to the junior and turn the power on. Make sure the POST now counts to 640K before the drive light is activated.

Reinstall the modified sidecar board into its case, and back onto the PCjr.

Again, turn the PCjr on and verify the POST to 640K with no errors. You must use the IBM Memory Options diskette to configure the DOS diskette to recognize your memory. If your DOS was already configured to recognize 256K it will automatically see the full 640K. Use CHKDSK to confirm you full memory capabilities.

DEBUGGING

If something doesn't work, our experience indicates that almost all of the problems are with soldering. Make sure no shorts were caused by your soldering.

If nothing happens when you test the finished board, check for a solder bridge shorting the power supply. One or more of the 256K chips could be installed backward. These chips will auto-destruct if power is applied to them when they are in wrong.

If the POST doesn't see any memory above 128K, one of the 256K chips is bad, or some of the pins on one or more of these chips is bent. If the switches are not properly set the adapter can act like this also.

If the POST counts past 128K but stops at a 128K boundary you should check the switches.

If the POST counts past 128K but not all of the way to 640K you probably have a bad 256K chip. Also check the jumper for a complete cut through or proper soldering on the jumper that you added.

If you get a "ERROR A" you probably have a bad 256K chip.

MICROSOFT BOOSTER 128K TO 512K COMPONENT SIDE

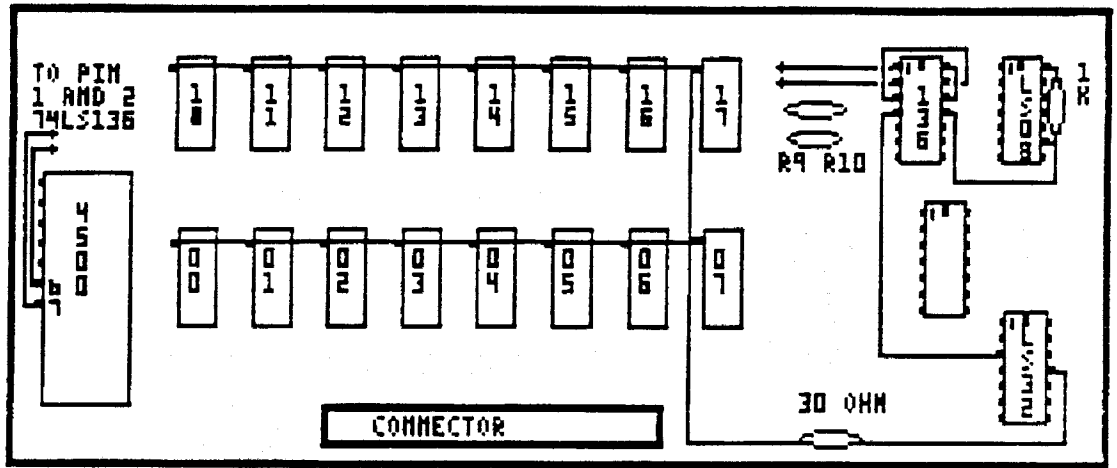

TRACE SIDE OF BOOSTER (BOTTOM)

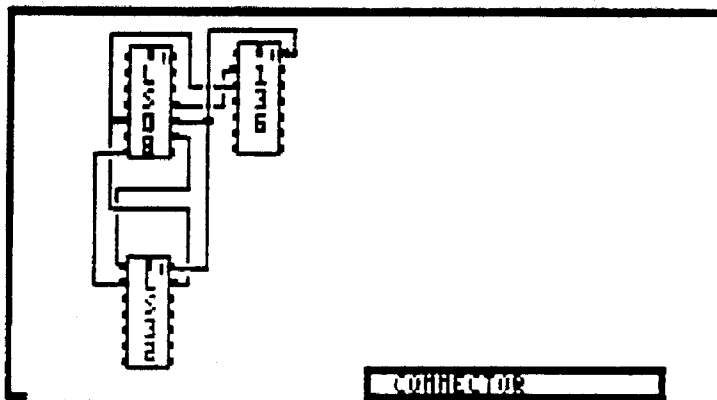

IBM PCjr 128 TO 512K UPGRADE

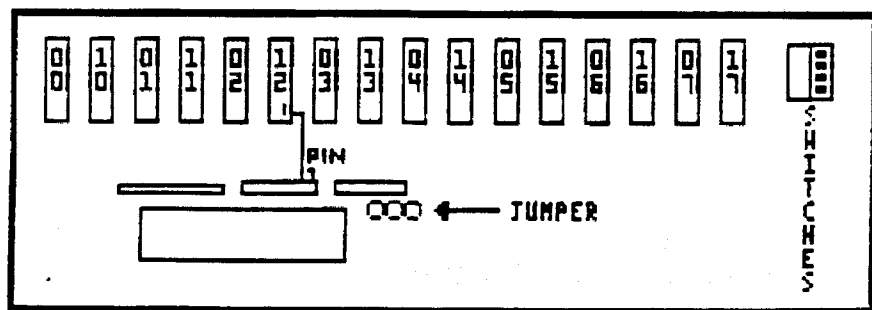

MICROSOFT BOOSTER 128K TO 512K UPGRADE

This change makes use of some unused circuitry on the existing chips on the board to modify the existing board to contain 512K of additional memory putting the junior at 640K.

WARNING: This modification is for people who are experienced in soldering and unsoldering on printed circuit boards.

PARTS NEEDED

16	256K DRAM BY 150 ns Chips
1	30 ohm 1/4 watt 5% resistor(or-blk-blk)
1	1K ohm 1/4 watt 5% resistor(brn-blk-red)
1	74LS136
18"	#26-#30 copper wire
1	14 pin socket

TOOLS NEEDED

1	Needle nose pliers
1	Small diagonal cutters
1	Small screwdriver
1	Low wattage soldering iron
1	Desoldering tool (solder sucker)
1	Soldering tool
Fine	Solder, rosin core

GETTING STARTED

Turn the power off to the junior and remove the booster. Remove the four mounting screws from the case completely. With a small screwdriver separate the case and remove the circuit board to a clean work area with plenty of light. Place the component side of the board up.

Remove the 74LS136 chip. If you have a good desolder tool (solder sucker) you can probably remove this chip in one piece. Or, you can cut the legs of the chip with diagonal cutters close to the chip end. Use the soldering iron and small needle nose pliers to remove the chip legs. Clean out the holes and all loose solder from the board. Install the 14 pin socket into the board and insert the new 74LS136. Reattach the board to the junior without the case and turn the junior on. The power on self test (POST) should count to 256K as normal.

Remove the 16-64K chips from th sockets noting which way they are orientated (pin 1 toward the top of the board). Bend up pin 1 on all of the 256K chips and install them into the sockets following the proper orientation. Strip about 7" of wire and connect all of the top row pin 1's together. Repeat this for the bottom row of chips. Connect the two rows together by soldering a wire from the top to the bottom row near the right end.

Connect one end of the 30 ohm resistor to the wire running between the top and bottom row of 256K chips, and the other end to pin 11 on the 74LS32. Trim the wires close to the board and attach the resistor to the board with tape to prevent any problem with shorting.

If you want you can desolder and remove the switches, otherwise turn them all OFF and tape over them. Never turn them on again. If they are accidentally turned on, CIRCUIT DAMAGE WILL RESULT.

Remove resistors 9 and 10. Turn the board over to the trace side (BOTTOM) and add the following wires to the board.

Pin 1 of the 74LS136 to pin 5 of the 74LS08
Pin 5 of the 74LS08 to pin 1 of the 74LS32
Pin 12 of the 74LS136 to pin 10 of the 74LS08
Pin 10 of the 74LS08 to pin 2 of the 74LS32.

Remove the 74LS136 and bend up pins 1,2,3,4,11 and 12. Reinsert it and make sure none of the bent up pins short to the socket. Run a wire from the bent up pin 4 of the 74LS136 to pin 3 of the 74LS32.

Install the booster on the junior and turn the power on. The POST should count to 640K. If it doesn't, check all wiring installed since the last check.

On the trace side (BOTTOM) of the board again, connect the following wires;

Pin 13 of the 74LS136 to pin 4 of the 74LS08
Pin 13 of the 74LS32 to pin 8 of the 74LS08
Pin 12 of the 74LS32 to pin 6 of the 74LS08

Turn the board over on the component side again. Cut and bend the leads on the 1K ohm resistor so it will fit between pin 9 and 14 of the 74LS08 and solder it in place. Don't let it stick up too high as it may interfere with the case. Add the following wires;

Pin 3 of the 74LS136 to pin 13 of the 74LS136
Pin 12 of the 74LS136 to pin 14 of the 74LS136
Pin 11 of the 74LS136 to pin 9 of the 74LS08
CAUTION: (DO NOT UNSOLDER THE 1K RESISTOR)
Pin 2 of the 74LS136 to pin 6 of the 4500A
Pin 1 of the 74LS136 to pin 7 of the 4500A

Now install the booster on the junior and turn the power on. It should count to 640K at the POST. You will have to configure your DOS diskette with the Microsoft software to recognize the additional memory. If you had a DOS diskette already made to recognize 256K it will recognize the full 640K without change. Use the CHKDSK command to see your full memory capability.

DEBUGGING

If something isn't working, experience with the modification shows that almost all of the problems are due to soldering. Make sure of all point to point connections. Make sure there are no soldering shorts.

If nothing happens when you turn the computer on there is something major wrong. If the computer works ok but fails with the Booster on the most common problems are;

- 1) A solder bridge has formed shorting the power supply.
- 2) One or more of the DRAM chips is installed backward. These chips will auto-destruct when power is applied to them and they are in backward.

If the POST doesn't see any RAM above the 128K installed in the Junior, then either one of the 256K chips is bad or some of the connections to the 74LS136 or the 74LS32 are wrong.

If the POST counts past 128K but not all the way to 640K you probably have a bad 256K chip. Also the wiring connections could be wrong. Try moving DRAM chips around to get a different POST count this indicates a bad DRAM chip.

If the POST counts up to 640K but software seems to not work correctly you have a problem with the pin 1 jumper on the DRAM's. Also the wiring connections can cause this problem.

POST failure with a "ERROR A" indicates a bad DRAM.

A V20 CHIP REVIEW AND INSTALLATION PROCEDURE

People have asked the advantages of the V20 by 5 mhz. processor over the standard, IBM supplied, 8088 processor. We have used and tested the V20 in the PCjr's here for 3 years with very good results. The game Loderunner, however, will not run with the V20 installed.

The many speed measurement programs are just so much rhetoric when in point of fact you really cannot discern the speed increase with your senses. The speed increase with the V20 is really noticed in program sorts, searches and screen updateing, or if, for any reason, the old 8088 is reinserted in place of the V20. These speed increases range from 10 to 40 percent.

We have heard of many people claiming to use the V20 by 8 mhz processor, but through numerous experiments the 8 mhz chip never responded with the correct timing function returns and would cause a no boot or system lockup situation.

The V20 installation is straight forward as it directly replaces the 8088 chip. The majority of PCjr's have a socketed 8088, but about 1 in 25 came off of the assembly line with a soldered in 8088. It is wise to check your chip before you make the purchase. The soldered in processor can be changed but it is not a job for the amateur and if you question your skill do not attempt it. To replace a motherboard can cost from \$175.00 to \$350.00 plus shipping.

Enough said, let's get on with the installation of the V20. First, turn off your junior and **UNPLUG THE AC POWER CORD**. At the top rear there are three notches, place a small flatblade screwdriver into the notches and pry upward. Remove the top cover completely and sit it aside.

DO NOT TOUCH THE DELICATE DRIVE MECHANISM. At the rear of the disk drive locate the wide gray cable and wiggle the cable connector off of the rear of the disk drive. The other end of this cable is connected to a vertical electronics board located to the left of the disk drive. Remove this controller board and cable as one assembly by pulling it straight up and out and set it aside.

The disk drive is in a plastic mounting bracket. The bracket has two mounting pins or feet at the rear that snap into the bottom of the case. The feet hold the drive in **FIRMLY**. Being aware of that, carefully grasp beneath the drive bracket, below the drive cable connector and to the right of the fan. Lift the rear edge up sharply. The drive will snap out. Sit the drive assembly outside of the junior with the remaining wires still attached.

The 8088 is located in about the center of the space occupied by the drive. Note that pin 1 of the chip is to the LEFT, the notched end of the V20 is installed to the LEFT. Remove the 8088 by prying it gently from its socket. The method that I use is to place a small flatblade screwdriver under the left end of the chip and turn the blade 90 degrees. This starts one end of the chip upward. Then I grasp the chip with my thumb on one end and forefinger on the other and rock the chip slightly back and forth until it comes out.

The V20 is somewhat sensitive to static shock, when you install it make sure to have your feet off of the carpet. To insert it, start the back 20 pins into the socket first and with some pressure on the chip align the front 20 pins into their holes. Push the chip down into the socket. Patience is the key to getting the chip into the socket.

Ok, job well done, now make the quick test. Sit the drive into the junior without snapping in the mounting feet. Plug in the power cord and video cable. Turn on the machine, the IBM LOGO should appear just as before. GREAT, turn the machine off and unplug it again.

Replace the drive, the front goes in first. There is a lip for a tongue and groove fit along the front bottom edge. Lower the rear mounting feet into place. The power cable and fan wires should be to the rear of the left mounting foot. align the feet with their holes and snap the bracket back into the case bottom.

Reinstall the disk controller board and attach the wide grey cable to the rear of the drive. Make sure all wires are connected before replacing the top. Remember to take this job slowly and check each step. Your junior is ready to go back online. If you wish to check speed, try NORTON'S SI program in Norton Utilities package.

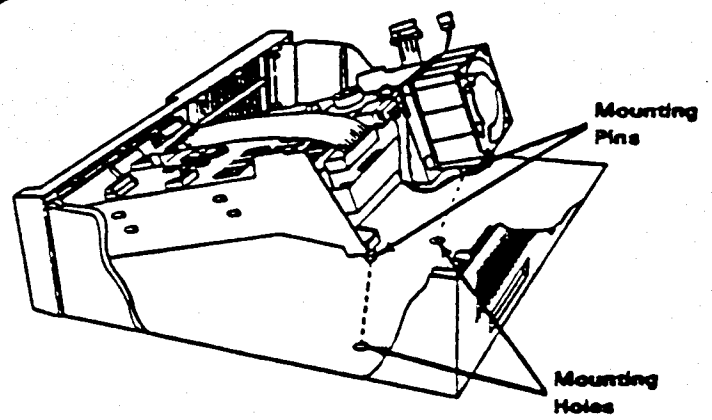
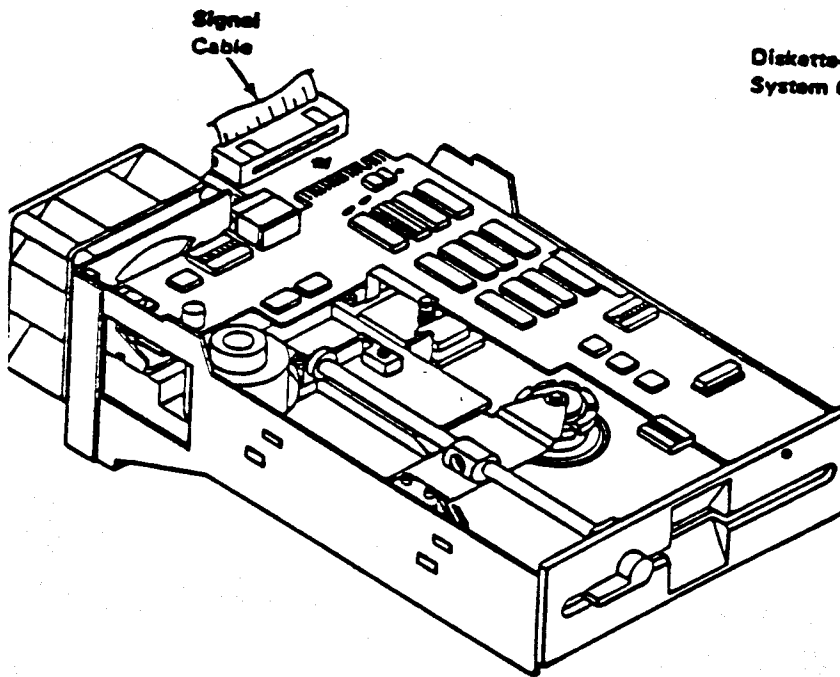
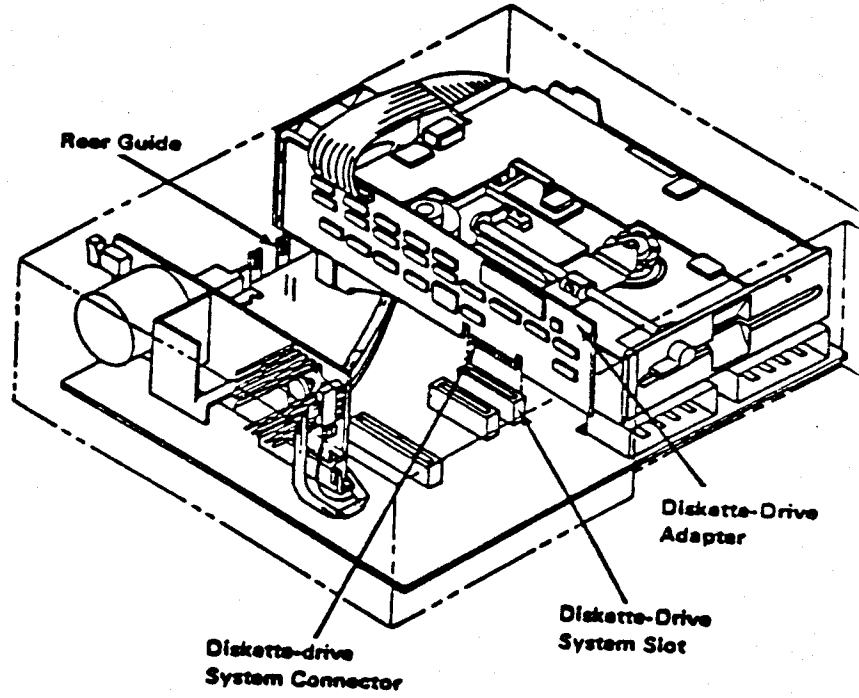
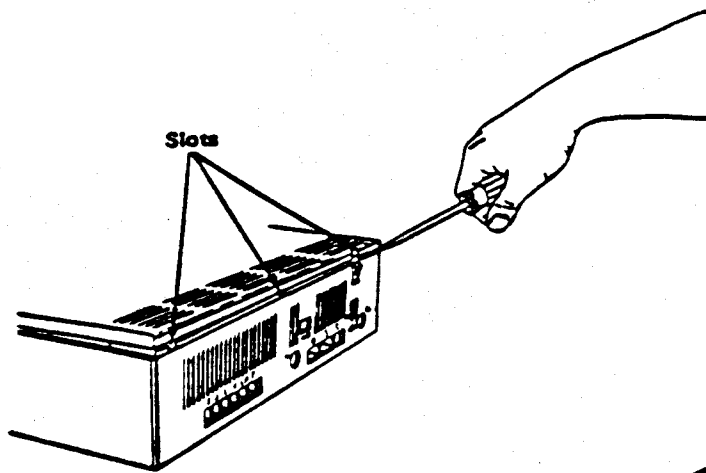

DOS PATCH FOR DOS 2.1

Due to an oversight, DOS 2.1 as it was manufactured has some limitations that will cause problems when the PCjr is trying to run larger programs like LOTUS, SYMPHONY, DBASE, MULTIMATE, and others. When the Junior is configured with 640K of RAM these programs should be able to run easily.

Unlike other PCs, the PCjr uses the non-maskable interrupt (NMI) to check its keyboard for input. Apparently, IBMDOS.COM (one of the two hidden disk operating files) does not properly restore the segment register and stack pointer after encountering a NMI. The problem often causes the PCjr keyboard to lock, and the Junior must be restarted to recover from the lockup. By using DEBUG to modify the IBMDOS.COM file this problem can be eliminated.

Make a diskcopy of the DOS 2.10 system disk and place the COPY into drive A. Enter the following commands exactly as shown, and the computer will prompt you. At the end of each line hit the (enter) key. Begin by typing;

```
A>DEBUG (enter)
-L 100 0 5 1
-D 12B L 4
####:012B 27 00 00 00
-E 12B
####:012B    27.20
-W 100 0 5 1
-Q

A>DEBUG IBMDOS.COM
-UCAC L A
####:03AC CS:
####:03AD MOV SP,[02A6]
####:03B1 CS:
####:03B2 MOV SS, [02A8]
-A3AC
####:03AC CS:MOV SS,[02A8]
####:03B1 CS:MOV SP,[02A6]
####:03B6 (enter)
-UCD1 L A
####:0CD1 CS:
####:0CD2 MOV SP,[02D1]
####:0CD6 CS:
####:0CD7 MOV SS,[02D3]
-ACD1
####:0CD1 CS:MOV SS,[02D3]
####:0CD6 CS:MOV SP,[02D1]
####:0CDB (enter)
-U1522 L A
####:1522 SS:
####:1523 NOV SP,[02D1]
####:1527 SS:
####:1528 MOV SS,[02D3]
```

```

-A 1522
####:1522 CS:MOV SS,[02D3]
####:1527 CS:MOV SP,[02D1]
####:152C (enter)
-U311D L 8
####:311D MOV SP,[02D1]
####:3121 MOV SS,[02D3]
-A311D
####:311D MOV SS,[02D3]
####:D121 MOV SP,[02D1]
####:3125 (enter)
-U325F L 4
####:325F MOV SP,ES
####:3261 MOV SS,SP
-A325F
####:325F MOV BP,ES
####:3261 MOV SS,SP
####:3263 (enter)
-U409B L 7
####:409B MOV SP,4325
####:409E MOV AX,CS
####:40A0 MOV SS,AX
-A409B
####:409B MOV AX,CS
####:409D MOV SS,AX
####:40A2 MOV SP,4235
####:40A5 (enter)
-W
WRITING 4280 BYTES
-Q

A>DEBUG
-L 100 0 5 1
-D 12B L 4
####:012B 20 00 00 00
-E 12B
####:012B 20.27
-W 100 0 5 1
-Q

```

This completes the modification to DOS. Save this diskette and use it to format all disks in the future. You can also use it with the SYS command to transfer the modified system files to your other diskettes containing the system files.

The segment of code marked ####:409B may show some variation from the addresses shown after the first ####:409B. This does not affect the addition of the code listed and works just fine.

ARCTIC FOX PATCH FOR THE PCjr

Electronic Arts' great tank battle game Arctic Fox in the copy protected version will not run on the Junior. Of course the copy protection is at fault for keeping the program from running on your machine.

First copy all the files on the Arctic Fox diskette to a new disk and copy DEBUG.COM to the new disk also. Using the copy rename AFOX16.EXE to A and begin;

```
DEBUG A      (ENTER)
U125F        (ENTER) You should see JZ 1264
A125F        (ENTER)
JMP 1264     (ENTER)
(ENTER)
U3F13        (ENTER) You should see INT 13
A3F13        (ENTER)
NOP          (ENTER)
NOP          (ENTER)
U3F1F        (ENTER) You should see INT 13
A3F1F        (ENTER)
NOP          (ENTER)
NOP          (ENTER)
(ENTER)
U3F2C        (ENTER) You should see INT 13
A3F2C        (ENTER)
NOP          (ENTER)
NOP          (ENTER)
(ENTER)
W            (ENTER)
Q            (ENTER)
```

RENAME A to AFOX.EXE

Now to run Arctic Fox on the Junior now just type AFOX and hit enter.

NOTE: This patch is not needed on the non copy protected version of this program put out by Electronic Arts.

NEWSROOM PATCH

The following debug session will allow you to copy the Newsroom files to any disk and run them from that disk. However, the Newsroom program will still want you to enter the clip-art disks in drive A: and any banner, panel, or wire service disks in will also have to be put in drive A:. None of the disks need any copy protection, so they can be copied from disk to disk and still be run.

Just follow the instructions carefully.

First copy all the Newsroom files on to a clean disk. Also copy your Debug program on to the same disk.

```
RENAME NWSRM.EXE NEW
DEBUG NEW
-E 691A EB 41
-E 6973 90 90
-E 6977 EB 25 90
-
```

(The following portion is telling the newsroom disk where to find certain files such as; LOGO.PIC, NRTITLE.PIC, and NRSETUP, along with all the printer and modem configuration tables.)

At the following locations enter the appropriate HEX value:

```
For drive A: 41
For drive B: 42
For drive C: 43
For drive D: 44
```

```
-E 8F4B XX
-E 92D2 XX
-E 9316 XX
-E 9349 XX
-E 9354 XX
-E 9B59 XX
-E 9B66 XX
-E 9B73 XX
-E 9B8F XX
-E 9BA5 XX
-E 9CD4 XX
-E 9D9D XX
-E 9DAA XX
-E 9DB7 XX
-E 9DCE XX
```

WHERE XX = The drive number denoted above.

```
-W
-Q
RENAME NEW NWSRM.EXE
```

```
DEBUG NWSRM1.OVL
-E 05DB 8B 46 04 89 46 FE 3B 46 04
-W
-Q
```

```
DEBUG NWSRM22.OVL
-E 10C6 B8 05 43
-W
-Q
```

That's all there is to it. Now just copy it over to any disk you want and run it from there. Just remember that it is going to look for certain files on the drive that you told it before in the debug session.

PRINTMASTER PATCH

This patch allows the user to unprotect PRINTMASTER, published (1985). The following steps assume that DEBUG.COM and the file PMMAIN.EXE are on the default disk drive. If not, add a drive specifier (A:, B:, C:, etc.) to the file names shown below. The procedure is as follows:

```
REN PMMAIN.EXE PMMAIN
DEBUG PMMAIN
-S 0000 FFFE CD 13
```

(This should return an address in the form xxxx:6C73, where xxxx is the current code segment. If the second part of the address is not 6C73, you have a different version, and this patch probably will not work. If it is 6C73, proceed with the following steps.)

```
-E 6C73 90 90
-E 6C7A 90
-W
-Q
REN PMMAIN PMMAIN.EXE
```

The version you have now created will run from an unprotected floppy in drive A, but since some of the file names used by the program are hard coded to be on drive A, there is another step to be performed before it can be run from the hard disk or RAM disk. The DOS command ASSIGN A=C must be executed (assuming the hard disk or RAM disk is drive C). This will direct all calls for drive A to drive C, where the program and its files are.

PRINTSHOP PATCH

Boot up with DOS in drive A. First make a backup of PRINT SHOP disk using COPYIIPC or COPYIIJR. copy DEBUG.COM to this disk.

```
A>REN PS.EXE PS
```

```

A>DEBUG PS
-S0 9000 CD 13
XXXX:06B6
XXXX:34E1 (Take the second value, subtract 2 (HEX) from it)
-UXXXX:34DF (Unassemble that code, XXXX the value from above)
XXXX:34DF MOV AH,04 (If you don't see this at the beginning
XXXX:34E1 INT 13 QUIT NOW you have a different version)
-AXXXX:34DF
XXXX:34DF MOV AH,00
XXXX:34E1 NOP
XXXX:34E2 NOP
-W
-Q

```

```
A>REN PS PS.EXE
```

Print shop is now totally unprotected, use dos's DISKCOPY or COPY command to make a backup.

ANCIENT ART OF WAR PATCH

1. Make a copy of the original distribution diskette using the DISKCOPY command. Put your original away, and work on the copy. Copy DEBUG.COM to your working WAR disk.

2. From the A> prompt, type:

```
RENAME WAR.EXE WAR (enter)
```

3. Now, start up DEBUG with:

```
DEBUG WAR
```

4. From the '-' DEBUG prompt, enter:

```
-E8BD8
```

5. DEBUG will display:

```
-xxxx:8BD8 CD-
```

The 'xxxx' will vary for your system, but if everything from the colon (:) onward doesn't look the same, DON'T continue - either you have different version, or something is wrong.

Type F8, and hit the space bar. DEBUG will display:

```
13-
```

Type 90, and hit the space bar. DEBUG will display:

```
73-
```

Type EB, and hit the space bar, and then (enter).

-W
-Q

A>RENAME WAR WAR.EXE (enter)

Your working copy of WAR will now run, and can, itself, be backed up using the DOS DISKCOPY or COPY commands.

NOTE: if you use WAR on a hard disk, you will not be able to save a game in progress, due to a small bug. WAR tests the default disk for the presence of a file named "M", instead of the selected data disk, the intent being to prevent saving a game on the same disk as that file. To disable this test, after completing step 5, and before the -W, patch the following location:

-xxxx:3B1D 0B-

replace the 0B with 31. This will allow you to save a game on a floppy disk in the A: drive; Note, however, that this removes a small margin of safety (if you save a new campaign and a game to the same disk, the game reloader will get confused).

ELECTRIC DESK 1.04 PATCH

Using the below patches, you will be able to make unlimited backups of the floppy, but more importantly, be able to boot the entire system off a hard disk.

The copy protection method used on this program expects an unusually formatted Track 9. The easiest way around this was to bypass the entire 'Verify Track 9' routine.

Make a copy of the file ELECTRIC.EXE; never work with your only copy. Copy DEBUG.COM to this disk. Place the program diskette in Drive A, and begin;

```
A> REN ELECTRIC.EXE ELECTRIC
A> DEBUG ELECTRIC
-R CS
CS XXXX          (Add 2000 to the number returned by DEBUG.)
                  (This becomes yyyy. Example; CS 2400 + 2000)
:(enter key)    (=4400 is (yyyy) value)
-S yyyy:0 FF00 B8 00 BF 78
YYYY:D145
-E yyyy:D145 E9 B0 00 00
-W
Writing 2D230 bytes .
-Q
A> REN ELECTRIC ELECTRIC.EXE
```

Use COPY A:*. * B: to move all files to a formatted diskette and you will have the whole system unprotected and copyable.

IBM ASSISTANT SERIES PATCHES

IBM Writing Assistant Version 1.01

Two versions of IBM Writing Assistant are available on your original program disks. One version is used if you have 128K and another version is used for 256K or more of available RAM. First determine which one is on your working copy disk.

TYPE DIR WRITE.*

128K will display WRITE.EXE
WRITE.SWP
256K will display WRITE.EXE
WRITE.NON

First copy all files to another disk and put your working copy away--copy a:*. * b:/v.

Here is the 128K (165,376 byte) version.

A>RENAME WRITE.EXE WRITE

A>DEBUG WRITE

-U 1314

You will see the following, if not type Q quit you have another version.

```
XXXX:1314 CD13 INT 13
XXXX:1316 B80102 MOV AX,0201
XXXX:1319 CD13 INT 13
XXXX:131B 721F JB 133C
XXXX:131D 81C30002 ADD BX,0200
XXXX:1321 B80102 MOV AX,0201
XXXX:1324 CD13 INT 13
XXXX:1326 7210 JB 1338
XXXX:1328 8A8711FE MOV AL,[BX+FE11]
XXXX:132C 324711 XOR AL,[BX+11]
XXXX:132F 3C74 CMP AL,74
etc...
```

Type in the following at the (-) prompt

```
-e 1314 90 90 90 90
-e 1324 90 90
-e 132F 39 C0
-w
-q
```

A>RENAME WRITE WRITE.EXE

Now the 256K (163,328 byte) version.

A>RENAME WRITE.EXE WRITE

A>DEBUG WRITE

-U 2B14

You will see the following, if not type Q quit you have another version.

```
XXXX:2B14 CD13 INT 13
XXXX:2B16 B80102 MOV AX,0201
XXXX:2B19 CD13 INT 13
XXXX:2B1B 721F JB 2B3C
XXXX:2B1D 81C30002 ADD BX,0200
XXXX:2B21 B80102 MOV AX,0201
XXXX:2B24 CD13 INT 13
XXXX:2B26 7210 JB 2B38
XXXX:2B28 8A8711FE MOV AL,[BX+FE11]
XXXX:2B2C 324711 XOR AL,[BX+11]
XXXX:2B2F 3C74 CMP AL,74
etc...
```

Type in the following at the (-) prompt

-e 2B14 90 90 90 90

-e 2B24 90 90

-e 2B2F 39 C0

-w

-q

A>RENAME WRITE WRITE.EXE

You now have an unprotected version of IBM Writing Assistant and can now copy the files onto a bootable disk. The WRITE.EXE file will no longer look for the hidden files on drive A. This was a problem before as we were stuck with a 320K formatted disk with no room for the operating system to be installed. It is important to keep the appropriate file (WRITE.SWP or WRITE.NON) with the WRITE.EXE file.

IBM Filing, Reporting and Graphing Assistant Programs

The procedure for unprotecting these is similar to that used for Writing Assistant (the 128k version) as the protection scheme used is identical (at least in my versions).

Filing Assistant (where FILE.EXE is 72,546 bytes)

A>RENAME FILE.EXE FILE

A>DEBUG FILE

-U 1718

You will see the following, if not type Q quit you have another version. XXXX:1718 CD13 INT 13

XXXX:B80102 MOV AX,0201

XXXX:CD13 INT 13

```
XXXX:721F JB 2B3C
XXXX:81C30002 ADD BX,0200
XXXX:B80102 MOV AX,0201
XXXX:1728 CD13 INT 13
XXXX:7210 JB 2B38
XXXX:8A8711FE MOV AL,[BX+FE11]
XXXX:324711 XOR AL,[BX+11]
XXXX:1733 3C74 CMP AL,74
etc...
```

Type in the following at the (-) prompt

```
-e 1718 90 90 90 90
-e 1728 90 90
-e 1733 39 C0
-w
-q
```

```
A>RENAME FILE FILE.EXE
```

Reporting Assistant (where REPORT.EXE is 79,872 bytes)

```
A>RENAME REPORT.EXE REPORT
```

```
A>DEBUG REPORT
```

```
-U 1518
```

You will see the following, if not type Q quit you have another version

```
XXXX:1518 CD13 INT 13
XXXX: B80102 MOV AX,0201
XXXX: CD13 INT 13
XXXX: 721F JB 2B3C
XXXX: 81C30002 ADD BX,0200
XXXX: B80102 MOV AX,0201
XXXX:1528 CD13 INT 13
XXXX: 7210 JB 2B38
XXXX: 8A8711FE MOV AL,[BX+FE11]
XXXX: 324711 XOR AL,[BX+11]
XXXX:1533 3C74 CMP AL,74
etc...
```

Type in the following at the (-) prompt

```
-e 1518 90 90 90 90
-e 1528 90 90
-e 1533 39 C0
-w
-q
```

```
A>RENAME REPORT REPORT.EXE
```

And finally for Graphing Assistant (125,440 bytes)

```
A>RENAME GRAPH.EXE GRAPH
```

```
A>DEBUG GRAPH
```

```
-U 5DA6
```

You will see the following, if not type Q quit you have another version.

```

XXXX:5DA6  CD13      INT    13
XXXX:      B80102    MOV    AX,0201
XXXX:      CD13      INT    13
XXXX:      721F      JB     2B3C
XXXX:      81C30002  ADD    BX,0200
XXXX:      B80102    MOV    AX,0201
XXXX:5DB6  CD13      INT    13
XXXX:      7210      JB     2B38
XXXX:      8A8711FE   MOV    AL,[BX+FE11]
XXXX:      324711    XOR    AL,[BX+11]
XXXX:5DC1  3C74      CMP    AL,74
etc...

```

Type in the following at the (-) prompt

```

-e 5DA6 90 90 90 90
-e 5DB6 90 90
-e 5DC1 39 C0
-w
-q

```

A>RENAME GRAPH GRAPH.EXE

Now you can rearrange the programs, make bootable disks, run from a ram disk or whatever. As always, if this doesn't work to your satisfaction, you have no recourse so please perform this on a DISKCOPY version of your software and not your distribution disk.

PFS-FILE PATCH (TYPE 1)

```

RENAME FILE.EXE TO FILE
DEBUG FILE
TYPE -> U 9243

```

You should see, among other things:

```

PUSH BP
MOV AX,DS
MOV ES,AX
(ETC)

```

If you don't see this, TYPE -> Q quit (You don't have the right version) otherwise,

```

TYPE -> E 9248 EB 2B
TYPE -> W
TYPE -> Q

```

A> RENAME FILE TO FILE.EXE.

You now have an unprotected copy of PFS-FILE.

PFS FILE PATCH (TYPE 2)

If you dont find the locations listed above try these:

```

PFS FILE TYPE -> U 9223 you should see PUSH BP
MOV AX,DS
MOV ES,AX
(ETC)

```

```

if so TYPE -> E 9228 EB 2B
TYPE -> W
TYPE -> Q

```

and follow the directions given above about RENAME etc.

PFS FILE PATCH (TYPE 3)

For those of you whose PFS:FILE does not match the other PFS patches on this board, try these:

For PFS:FILE, copy FILE.EXE to another disk, and do:

```
RENAME FILE.EXE FILE
```

```
DEBUG FILE
```

```
U 9213
```

```
should show ...   PUSH BP  
                   MOV CX,0004
```

which is the first part of a timing loop. if it doesn't, quit; else do:

```
E 9217 EB 18
```

```
U 9213
```

```
should show ...   PUSH BP  
                   MOV CX,0004  
                   JMP 9231
```

if so, do:

```
W
```

```
Q
```

```
RENAME FILE FILE.EXE
```

If everything was OK, your new versions of PFS:FILE should run just fine without the original diskettes.

PFS REPORT PATCH (TYPE 1)

```
RENAME REPORT.EXE REPORT
```

```
TYPE -> DEBUG REPORT
```

```
TYPE -> U 98BF
```

```
You should see, among other things:  PUSH BP  
                                       MOV AX,DS  
                                       MOV ES,AX  
                                       (ETC)
```

If you don't see this, TYPE -> Q quit (You don't have the right version) otherwise,

```
TYPE -> E 98C4 EB 2B
```

```
TYPE -> W
```

```
TYPE -> Q
```

```
A> RENAME REPORT REPORT.EXE.
```

You now have an unprotected copy of PFS-REPORT.

PFS REPORT PATCH (TYPE 2)

If you dont find the locations listed above try these:

```
TYPE -> U 988F  you should see  PUSH BP  
                                       MOV AX,DS  
                                       MOV ES,AX  
                                       (ETC)
```

```
if so TYPE -> E 9894 EB 2B
```

```
TYPE -> W
```

```
TYPE -> Q
```

and follow the directions given above about RENAME etc.

PFS REPORT PATCH (TYPE 3)

For those of you whose PFS:REPORT does not match the other PFS patches on this board, try these:

For PFS:REPORT, copy REPORT.EXE to another disk, and do:

```
RENAME REPORT.EXE REPORT
DEBUG REPORT
U 9875
should show ...   PUSH BP
                   MOV AX,DS
                   MOV ES,AX
if it doesn't, quit; else do:
E 987A EB 11
U 9875
should show ...   PUSH BP
                   MOV AX,DS
                   MOV ES,AX
                   JMP 988D
if so, do:
W
Q
A>RENAME REPORT REPORT.EXE
```

PFS WRITE PATCH

```
RENAME PFSWRITE.EXE PFSWRITE
DEBUG PFSWRITE
U 235A
You should see, among other things:  INT 13
                                       JNB 2362
```

```
If you don't see this, TYPE -> Q (you don't have the right
version) otherwise,
TYPE -> E235A 90 90 90 90
TYPE -> E2360 90 90
TYPE -> A2369
TYPE -> CMP AX,AX
TYPE -> <cr>
-W
-Q
```

```
A> RENAME PFSWRITE PFSWRITE.EXE.
You now have an unprotected copy of PFS-WRITE.
```

HOMEWORD PATCH

First format a new system disk, then copy all the Homeword files to it.

Next, rename the Homeword program file HWCMP.EXE to HWCMP.TMP. Copy DEBUG.COM to this diskette and enter;

```
debug hwcomp.tmp (CR)
e cs:59f eb 05 (CR)
w (CR)
q (CR)
```

Now, rename HWCMP.TMP to HWCMP.EXE
That should do it. At least it worked for me on version 1.0

ENABLE PATCH

This is the procedure to unprotect the integrated software package called ENABLE , Vers 1.00

If you have a hard disk or want to create a backup copy that is not tied to the original ENABLE system disk, this will remove the copy protection completely.

This procedure is to be used by legitimate owners of ENABLE only, as you are entitled to make a back up for archive purposes only. You are bound by your licence agreement.

Format a blank disk using DOS 2 or 2.1 (Do not use the /s option.)

Label it the same as the original ENABLE system disk.

Copy the files from the original ENABLE system to the formatted blank disk using *.* . Copy DEBUG.COM to this diskette and enter;

```
DEBUG B:SYSTEM.TSG
```

```
S CS:0 L EFFF B8 01 04
```

(You should see)

```
XXXX:069C
```

```
XXXX:XXXX < this one doesn't matter!
```

(If you don't see this - type q and enter - you have a different version!)

(otherwise)

```
E 069C (enter)
```

```
B8.EB 01.2D 04.90 (enter)
```

```
W
```

```
Q
```

Now all the copy protection has been removed, and you may copy the files as required. All checks for specially formatted tracks has been removed. Disk needs no longer to be in the A drive on start up.

BASIC PROGRAMMING - HELPFUL HINTS

First of all let's cover what BASIC is, it is a programming language within which the majority of commands are built into a ROM chip contained in the PCjr. Additional commands are carried in the BASIC Cartridge and the majority of programmers program in the commands from both units.

It is easy to start the BASIC language processor, after booting DOS you simply type BASIC at the A> prompt. If you do not have the cartridge in place the basic file is read from the DOS diskette.

The basic screen is ready to begin programming in the BASIC language or to load and run programs that have already been programmed. At the bottom of the screen is a list of the "SOFT KEYS" commands which are key assignments initially given to the function keys. The list is as follows;

F1	LIST	F6	,"LPT1:"
F2	RUN (CR)	F7	TRON (CR)
F3	LOAD"	F8	TROFF (CR)
F4	SAVE"	F9	KEY
F5	CONT (CR)	F10	SCREEN 0,0,0 (CR)

The (CR) means the (ENTER) key completes this command. If you are in the 40 column mode when you enter BASIC you will see only F1-5 commands but all are there. If you are in the 80 column mode you will see all of the commands.

BASIC programs have filename extensions of .BAS. If, for example, we wanted to run a basic game named HORSE.BAS when we have gotten to the BASIC screen we would type;

RUN"HORSE (enter)

and this would begin the horse game. If a basic program does not contain a specific key allowing you to end the program, usually FN+B(break) will allow you to exit the program. If you wish to change the program that is loaded into the computers memory you can use the command "NEW" and hit enter. This command would remove the HORSE game and ready the computers memory to load and run another program. When you are done using BASIC you can return to the DOS system prompt by typing.

SYSTEM (enter)

CONTROL AND ALTERNATE KEY CODES

When in BASIC the ALTERNATE or CONTROL keys combined with another letter key can save you some time typing. Here is a list of the Alternate key conventions in BASIC;

ALTERNATE KEY CHART

Press the ALTERNATE key and-

A=AUTO, B=BSAVE, C=COLOR, D=DELETE, E=ELSE, F=FOR, G=GOTO,
H=HEX\$, I=INPUT, K=KEY, L=LOCATE, M=MOTOR, N=NEXT, O=OPEN,
P=PRINT, R=RUN, S=SCREEN, T=THEN, U=USING, V=VAL, W=WIDTH,
X=XOR(called exclusive or).

CONTROL KEY CHART (Editing assistance keys)

Press the CONTROL key and-

B=JUMP BACK A WORD, C=DELETES A LINE AS IT MOVES THE CURSOR
DOWN A LINE, E=DELETES FROM CURSOR TO END OF LINE, F= JUMP
FORWARD A WORD, H=DELETES A CHARACTER TO THE LEFT OF THE
CURSOR AND PULLS THE REST OF THE LINE UP, I=JUMPS A TAB,
J=JUMP DOWN A LINE, K=JUMP UP A LINE, L=CLEAR THE SCREEN AND
HOME THE CURSOR, N=JUMP TO THE END OF THE LINE, R=INSERT AT
CURSOR.

BASIC LINE ROUTINES

The majority of people who learn BASIC learn to use it by looking at the way other people have programmed certain sections of their programs. Remember, each basic program is made up of small basic programs all put together to form the larger program. With that in mind these line routines are included to help you see the way that some effects can be created in BASIC.

Since the PCjr keyboard buffer can read and store up to 15 keypresses, a routine asking for keyboard input may get a wrong input from what is stored in the keyboard buffer, unless the buffer is cleared of information first.

To clear the keyboard buffer-

```
10 DEF SEG=0:POKE 1050,PEEK(1052) (clear keyboard buffer)
20 B$=INKEY$:IF B$="" THEN 1010 (reads keyboard input)
```

To turn the screen off-

```
X=INP(986):OUT 986,0:OUT 986,0
```

To turn the screen back on-

```
X=INP(986):OUT 986,0:OUT 986,8
```

These statements will turn off the screen and allow you to perform a function or write to the screen and turn the screen on again making the item appear to jump on the screen all at once.

To set the border color-

```
X=INP(986):OUT 986,2:OUT 986,(COLOR #)
```

To center a string on screen-

```
X$="YOUR STRING"
```

```
L=((SCREEN WIDTH)-LEN(X$))/2:LOCATE ROW,L:PRINT X$
```

To enter the Caps Lock Mode from BASIC-

```
10 DEF SEG=&H40
```

```
20 POKE &H17,(PEEK(&H17) OR &H40)
```

To clear the screen-

```
PRINT CHR$(12)
```

To set random numbers using the clock-

```
RANDOMIZE VAL(TIME$) or RANDOMIZE VAL (RIGHT$(TIME$,2))
```

To output print vertically on the screen-

```
10 CLS:WIDTH 80
```

```
20 PRINT "ENTER WORD OR PHRASE TO BE PRINTED VERTICAL"
```

```
30 INPUT W$
```

```
40 PRINT "ENTER POSITIONS TO TAB 1-80"
```

```
50 INPUT P
```

```
60 L=LEN(W$)
```

```
70 FOR X=1 TO L
```

```
80 C$=MID$(W$,X,1)
```

```
90 PRINT TAB(P) C$
```

```
100 NEXT X
```

```
100 END
```

To display the different colors on the screen-

```
10 CLS:SCREEN 0,1:WIDTH 40
```

```
20 Z$="12345678901234567890"
```

```
30 FOR B=0 TO 7
```

```
40 FOR A=0 TO 15
```

```
50 COLOR A,B
```

```
60 PRINT Z$;"FORE=";A;"BACK=";B
```

```
70 FOR Q=1 TO 300:NEXT Q
```

```
80 NEXT A
```

```
90 NEXT B
```

```
100 COLOR 7,0
```

```
110 END
```

To produce a Phaser sound-

```
10 CLS:INPUT "Enter Number of CYCLES";NC: Rem (TRY 6)
```

```
20 INPUT "Enter Starting PITCH";P1: Rem (TRY 1500)
```

```
30 INPUT "Enter Ending PITCH";P2: Rem (TRY 4000)
```

```
40 INPUT "Enter Pitch INCREMENT";DP: Rem (TRY 300)
```

```
50 D=1
```

```
60 FOR B=1 TO NC
```

```
70 FOR C=P1 TO P2 STEP DP
```

```
80 SOUND P,D
```

```
90 NEXT C
```

```
100 NEXT B
```

```
110 PRINT
```

```
120 GOTO 10: Rem (To keep repeating the sound goto 60)
```

```
(FN+BREAK ends program)
```

To produce a Siren sound-

```
10 CLS:INPUT "Enter Number of CYCLES";NC: Rem (TRY 2)
20 INPUT "Enter Starting PITCH";P1: Rem (TRY 300)
30 INPUT "Enter Ending PITCH";P2: Rem (TRY 600)
40 INPUT "Enter Pitch INCREMENT";DP: Rem (TRY 1)
50 INPUT "Enter Holding TIME";D: Rem (TRY 1)
60 FOR A=1 TO NC
70 FOR B=P1 TO P2 STEP DP
80 SOUND B,D:NEXT B
90 FOR C=P2 TO P1 STEP -DP
100 SOUND C,D:NEXT C
110 NEXT A
120 PRINT
130 GOTO 10: (To keep repeating the sound goto 60)
(FN+BREAK ends the program).
```

The REM statements give suggested values for you to try, they do not have to be typed into the routine. You may experiment with many different values to produce different effects.

To produce a Clock tick-

```
10 CLS
20 SOUND 12500,.35
30 FOR X=1 to 600
40 NEXT X
50 GOTO 20
```

To draw a Highway-

```
10 CLS
20 FOR X=1 TO 79
30 LOCATE 4,X
40 PRINT CHR$(219)
50 LOCATE 20,X
60 PRINT CHR$(219)
70 NEXT X
80 FOR Y=1 TO 79 STEP 8
90 LOCATE 12,Y
100 PRINT CHR$(223)+CHR$(223)+CHR$(223)+CHR$(223)
110 NEXT Y
```

To draw a Mountain-

```
10 CLS
20 FOR A=1 TO 20
30 B=23-A
40 LOCATE B,A
50 PRINT CHR$(219)
60 NEXT A
70 FOR A=21 TO 41
80 B=A-19
90 LOCATE B,A
100 PRINT CHR$(219)
110 NEXT A
120 FOR C=1 TO 79
130 LOCATE 22,C
140 PRINT CHR$(219)
150 NEXT C
```

To draw four viewports-

```
10 SCREEN 1: VIEW: CLS: KEY OFF
20 VIEW (1,1)-(151,91),,1
30 VIEW (165,1)-(315,91),,2
40 VIEW (1,105)-(151,195),,2
50 VIEW (165,105)-(315,195),,1
60 LOCATE 2,4: PRINT "Viewport 1"
70 LOCATE 2,25: PRINT "Viewport 2"
80 LOCATE 15,5: PRINT "Viewport 3"
90 LOCATE 15,25: PRINT "Viewport 4"
100 VIEW (1,1)-(151,91): GOSUB 1000
200 VIEW (165,1)-(315,91): GOSUB 2000
300 VIEW (1,105)-(151,195): GOSUB 3000
400 VIEW (165,105)-(315,195): GOSUB 4000
500 END
1000 CIRCLE (65,50),30,2 'circle
1010 RETURN
2000 LINE (45,50)-(90,75),1,B 'line
2010 RETURN
3000 FOR D=0 TO 360: DRAW "ta=d;nu20": NEXT 'spokes
3010 RETURN
4000 PSET (60,50),2: DRAW "e15;f15;130" 'triangle
4010 RETURN
```

Sorting routines-

THE BUBBLE SORT

```
10 CLS:KEY OFF
20 INPUT "HOW MANY WORDS";N%
30 DIM A$(N%+1)
40 FOR N=1 TO N%
50 INPUT "ENTER WORD";A$(N)
60 Z=Z+1
70 NEXT N
80 CLS:M$="ALPHABETIZING":COLOR 0,7:
LOCATE 10,(20-LEN(M$)/2):PRINT M$:COLOR 7,0
90 T=N-1 'begin the sort routine
100 FLAG=0:FOR S=1 TO T:IF A$(S)<=A$(S+1) THEN 160
110 SWAP A$(S),A$(S+1):FLAG=1:T=S
120 NEXT S:IF FLAG=1 THEN 100
130 FOR N=2 TO Z+1 'out to screen
140 F=F+1
150 IF F>22 THEN GOSUB 180
160 PRINT A$(N)
170 NEXT N:END
180 COLOR 0,7:PRINT "HIT ANY KEY TO
CONTINUE";:COLOR 7,0
190 AN$=INKEY$:IF AN$="" THEN 190
200 CLS:F=0:RETURN
```

```

THE SHELL SORT
10 CLS:KEY OFF
20 INPUT "HOW MANY WORDS";N%
30 DIM A$(100) 'limit of 100 words
40 FOR N=1 TO N%
50 INPUT "ENTER WORD";A$(N)
60 V=V+1
70 NEXT N
80 CLS:M$="ALPHABETIZING":COLOR 0,7:
LOCATE 10,(20-LEN(M$)/2):PRINT M$:COLOR 7,0
90 N=N% 'begin sorting routine
100 L=(2^INT(LOG(N)/LOG(2)))-1
110 L=INT(L/2)
120 IF L<1 THEN 250
130 FOR J=1 TO L
140 FOR K=J+L TO N STEP L
150 I=K
160 T$=A$(I)
170 IF A$(I-L)<=T$ THEN 210
180 A$(I)=A$(I-L)
190 I=I-L
200 IF I>L THEN 170
210 A$(I)=T$
220 NEXT K
230 NEXT J
240 GOTO 110
250 FOR N=1 TO V
260 F=F+1
270 IF F>22 THEN GOSUB 300
280 PRINT A$(N)
290 NEXT N:END
300 COLOR 0,7:PRINT "HIT ANY KEY TO CONTINUE";:
COLOR 7,0
310 AN$=INKEY$:IF AN$="" THEN 310
320 CLS:F=0:RETURN

```

Of these two sorts the second (SHELL) is faster. Try then to see the sorting capabilities of BASIC.

Below is a sort routine from a database program used to track names and addresses. The program sorts these fields, LN\$=Lastname, NA\$=Firstname, AD\$=Address, CS\$=City,State,Zip, TEL\$=Telephone Number, and PURC\$=Extra Information

```

DATABASE SORT
200 CLS:LOCATE 10,12:PRINT "Sorting entries" 'SORT ROUTINE
210 M%=N%
220 M%=INT(M%/2)
230 IF M%=0 THEN 370
240 K%=N%-M%:J%=1
250 I%=J%
260 L%=I%+M%

```

```

270 IF LN$(I%)>LN$(L%) THEN 310
280 IF LN$(I%)=LN$(L%) THEN 350
290 J%=J%+1:IF J%>K% THEN 220
300 GOTO 250
310 X$=LN$(I%):X1$=NA$(I%):X2$=AD$(I%):X3$=CS$(I%):
    X4$=TEL$(I%):X5$=PURC$(I%)
320 LN$(I%)=LN$(L%):NA$(I%)=NA$(L%):AD$(I%)=AD$(L%):
    CS$(I%)=CS$(L%):TEL$(I%)=TEL$(L%):PURC$(I%)=PURC$(L%):
    LN$(L%)=X$:NA$(L%)=X1$:AD$(L%)=X2$:CS$(L%)=X3$:
    TEL$(L%)=X4$:PURC$(L%)=X5$
330 I%=I%-M%:IF I%<1 THEN 290
340 GOTO 260
350 IF NA$(I%)>NA$(L%) THEN 310
360 GOTO 290
370 RETURN

```

BASIC NOTES

IBM PCjr COMPATIBILITY LISTING

The following software titles are listed alphabetically and are comprised from many lists and personal contacts with PCjr owners. These software titles are considered to be compatible with the Junior in the configuration denoted by the amount of memory and associated notes. Since there were so many sources for the lists, we cannot insure 100% compatibility, but we have done considerable work in an attempt to make it so.

In some cases the software will require a "PATCH" to run correctly on the Junior. This patch is either contained in this book or contained on disk #56 JR PATCHES which can be obtained from JR NEWSLETTER P.O. Box 163 Southbury, Ct. 06488 for a price of \$7.00 shipping included.

Memory requirements for many programs will change when the program is updated to a newer version. Some programs will also run more quickly and smoothly with a larger amount of memory in the computer. We suggest that you read carefully before buying.

The following footnotes are used to indicate the amount of memory needed to run a program. They are listed directly after the program name.

1 = 128K	2 = 256K
3 = 384K	5 = 512K
6 = 640K	

These footnotes list any special requirements or added features to aid in the use of the program.

NOTE 1 - The program needs 2 disk drives, or 1 disk drive and ram disk to run effectively.

NOTE 2 - The program needs a patch to run on the Junior. The patch is either listed in this book or is contained on the JR PATCHES diskette.

NOTE 3 - Non copyprotected version of the program is needed to run on the Junior without a patch.

NOTE 4 - Program has joystick problems.

NOTE 5 - Program needs DOS version 3.0 or later to run.

NOTE 6 - Speech attachment required or suggested.

NOTE 7 - Need a Jr version of program or setup instructions for memory expansion to run program.

NOTE 8 - Mouse required or helpful in program execution.

NOTE 9 - Program shows problems running on the Junior.

A Mind Forever Voyaging 1
 A+ Series 1
 A> Cook
 Ability 3 Note 1
 Ace of Aces 2
 Advanced Flight Trainer 2
 Note 2,3
 Adventure 1
 Adventure in Serenia 1.00 1
 Adventures in Math 1.00 1
 Agent USA 1
 Alge-Blaster 1
 Alley Cat 2 Note 5
 Alpha Build 2
 Alphabet Zoo 1 Note 4
 Alter Ego 1
 Amazon 1
 America Cooks Series 2
 American Challenge 1
 Amoritizer III
 Amulet of Yendor 3
 Ancient Art of War 2
 Ancient Art of War at Sea 2
 Andromeda Conquest 1
 Animation Creation 1.00 1
 APBA Baseball 1
 Application Display 1
 Management System 1.00 2
 Arcade Games 1
 Archon 1
 Arithmetic Games
 Set 1 1.00 1
 Set 2 1.00 1
 Art Gallery I & II 1
 Art Studio 1
 Artificial Intelligence ?
 As Easy As 1
 Auto Cad 6 Note 1
 Auto Sketch 6 Note 1
 B-1 Bomber 1
 Backgammon ?
 Back to Basic 1
 Balance of Power 6 Note 9
 Ballyhoo 1
 Bank Street Story Book 1
 Bank Street Writer/Plus 1
 Barron's Computer SAT 1
 Bartender's Guide 1
 Basic Building Blocks 1
 Basic Compiler 1.00 1
 Basic Primer 1.00 1
 Battle Chess 5
 Battle for Normandy 1

Battle of Antietam 1
 Below the Root 1
 Beneath Apple Manor 1
 Black Cauldron 1
 Board Games 1
 Bop 'N Wrestle 1
 Borrowed Time 1
 Boulderdash 1
 Boulderdash Construction Set ?
 Bouncy Bee Learns Letters 1
 Note 6
 Bouncy Bee Learns Words 1
 Note 6
 Boyan 3
 Brain Booster 1 (BASIC)
 Breakers 1
 Bridge ?
 Bridgemaster 1
 Bridge Parlor ?
 Bruce Lee 1
 Bugs ?
 Build A Book 1
 Bumble Games 1.00 1
 Bumble Plot 1.00 1
 Burger 1
 Bushido 2
 C Compiler 4.0 1
 Call To Arms 1
 CCS Design - CAD 3
 Calendar Creator 1
 Calendars and Stationary ?
 Casino Games 1.05 1
 Castle 1
 Castle Wolfenstein/Return To
 Cave Quest ?
 Centipede 1 Note 7
 Certificate Maker 1
 Championship Boxing 1
 Championship Golf 1
 Championship Lode Runner 1
 Chart Master 1
 Checkers 1
 Check Master ?
 Chem Lab 1
 Chessmaster 2000 2
 Chi Writer 2
 Christmas Kit ?
 Chuck Yeager's A.F.T. 2
 Note 2
 City Desk ?
 Circus Maximus 1
 Classmate 1
 College Decision 1

Color Paint 1	Note 8	DOS 2.1	1
Commando ?	Note 4	DOS 3.0	1
Complete Scard ?		DOS 3.1	1
Computer Baseball	1	DOS 3.2	1
Computer Crosswords(Dell)	1	DOS 3.3	1
Computer Joker	1	Dow Jones Reporter	1.00 1
Computer Teacher	2	Dr. Lusher's Color	1
Conflict in Vietnam	1	Drafix ?	
Copy IIJR	1	Dragon World	1
Cornerstone 5.2 ?		Draw-It	1
Cosmic Crusader	2	DS Backup ?	
Coupon Mizer ?		DWSCRIPT	1
Creative File and Calc ?		Early Games for Young	
Crime and Punishment	1	Children	1
Cross Fire (ROM Cartridge)	1	Earth Science Series	1
Crosstalk XVI	3	- Hydrologic Cycle	
Crossword Maker	1	- Ground Water	
Crusade in Europe	1	- Surface Water	
Cut and Paste ?		- Moisture in the	
Cutthroat ?		- Atmosphere	
Dac Easy Accounting V1.0 ?		Easy Writer 1.15	1
Dam Busters	1	Easy As ABC	1 Note 7
Dark Castle ?		Electric Desk	1
Data Manager	2	Enchanter	1
Dave Winfields Batter Up	1	Energraphics	1
dBase II V2.4	2	Equator	1
dBase III V1.1	2	ESP ?	
dBase III Plus	3	Eureka: The Solver	3
Deadline	1	Evelyn Wood Dynamic Reader	1
Decision in the Desert	1	Executive Filer	1
Deep Space ?		Executive Suite	1
Delta Draw	1	Executive Writer	1
Demon Attack	1	Express Calc	2
Demon's Forge	1	Express Check	2
The Designer's Pencil	1	Extended Text and Graphics	6
Deskmates/PC-Deskteam	1	EZ Forms ?	
DeSMET C 2.4	1	F-15 Strike Eagle	1
Diagram Master 6	Note 1	Facemaker	1 Note 8
Dig Dug ?		Fahrenheit 451	1
Directory Magic	1	Fact Track 1.00	1 Note 1,5
Directory Service	2	Family History	2
Disk Catalog IV	1	Family Roots	1
Disk Manager	2	Fancy Font	1
Disk Optimizer	1	Felony	1
Diskette Librarian 1.00	1	File Command	1
DisplayWrite 1	1	File Express	3
DisplayWrite 2 (Ver. 1.1)	2	File Facility	1
Note 2		Filers Choice	1
DisplayWrite Assistant	3	Filing Assistant	1
Dollars and Sense V2.0	2	Finance I and II	1
Donald Duck's Playground	1	Finance Manager	1
DOS A Matic	2	Financer Junior	1
DOS Assistant	1	First Publisher	5

Flash	1	Hard-Hat Mack	1
FlashCalc V1.00	1	Hardball	?
Fleet Sweep	1	Harvard Presentation	
Flight Simulator	1	Graphics	5
Fontasy V1.0	1	Hellcat Ace	2
Fooblitzzy	1	Hey Diddle Diddle	1
Football	1	High Stakes	?
For Juniors Only	1 BASIC	Hitchhiker's Guide to Galaxy	1
Forbidden Castle	1	Hobbit	1
Form Worx	2	Holy Grail	1
Fortran Compiler 1.00	1	Home Accounting Plus	1
Fraction Fever	1	Home Budget Jr. 1.00	1
Framework II	5	Home Inventory	1
Freddy's Rescue	1	Home Management	?
Freelance	5	HomeWord 1.00	1
Friendly Writer/Speller	1	Homework Helper Reading	1
Frogger	1	Homework Helper Writing	1
Full File Manager	1	Hopper	1
Funnels & Buckets	1	IBM Writing Assistant	1
F-15 Strike Eagle	1	DisplayWrite Assistant	2
Galaxy	2	Filing Assistant	2
Galaxy Trek	?	Reporting Assistant	1
Gambler	1	Graphing Assistant	1
Game Star Golf	2	Macro Assembler 4.0	1
Games 1,2,3,4	1 (BASIC)	Planning Assistant	1
GATO	1	Assistant Home Solutions	
GBA Championship Basketball	2	Executive Solutions	1
Generic CAD	5	Accounting Solutions	1
Gertrude's Puzzles	1	Icon	1
Gertrude's Secrets	1	Ikari Warriors	?
Get Organized	1	Imageprint	1
Gettysburg	2	Inca	?
GFL Championship Baseball	2	Info PC	?
Football		InWord	1
Ghost Busters	1	Indiana Jones	2
GMAT	1	Infiltrator	1
Goldfinger	2	In Search of Most Amazing	
Golden Common Lisp	5	Thing	1
Golf's Best	1	Instant Page	2
Golf Cap	?	Instant Replay	1
Grammar Gremlins	1	Invaders	1
Grand Slam Baseball	1	It Figures	1
Graph In the Box	3	Japanese	?
Graphing Assistant	3	J.K. Lasser's Your Money	
Graphic Sports	?	Manager	1
Graphix Partner	1	Jenny of the Prairie	1
Toolbox	1	Jet (Sublogic)	1
Gulf Strike	1	Jim Fixx's Running Program	1
Gunship (Microprose)	3	Jingle Disk	2
Note	9	Jr Budget	1
Hacker & Hacker II	1	Jr Music Machine	1
HAL	5	Jrtele	1
Hard Disk Manager III	3		

Juggles' Butterfly 1
 Jumpman 1
 Karateka 2
 Karel the Robot 1
 K EDIT 2
 Keyboard Cadet 1
 Keydex 1
 Keywords 1
 Kid Writer 1
 Kids on Keys 1
 Kid's Stuff 1
 Kindercomp 1
 King's Quest I,II, III 1
 KMAN 3 Note 9
 Kung Fu 1
 Label Master ?
 Land of the Lounge Lizards 1
 Language Teacher 1
 Lattice C 2.12 1
 Lattice C 2.14 3
 Leading Edge Word Processor
 2 Note 1
 Learning DOS 1
 Leather Goddess of Phobos 1
 Leisure Suit Larry ?
 Lettrix 2
 Lightning ?
 Linkword French 1
 German
 Spanish
 Lode Runner/Championship 1
 Logo 1.00 1
 Lotus 123 Cartridge 1
 Lotus 123 Disk 2
 Lovejoy's SAT 1
 Lunar Explorer 1
 Luscher Profile 1
 Macro Assembler 1.00 1
 Mahjong ?
 Managing the Market 2
 Managing Your Money 2
 Mailing List Manager 1.00
 Note 9
 Mase Utilities 2
 Master Type ?
 Math Blaster 1
 Math Climbers ?
 Math Magic ?
 Mavis Bacon Teaches Typing 1
 Mean 18 2
 Max Think 1
 Mickey Mouse Space Adventure
 MicroLeague Baseball 2

Micro Plot 1
 MicroSoft Access ?
 MicroSoft Chart ?
 MicroSoft Project ?
 MicroSoft Word 2
 Microsoft Windows 1.01 6
 Millionaire 1
 Mind Mirror Note 9
 Mind Prober 1
 Mind Reader 5
 Mirror 3.6 2 Note 9
 Monopoly 2
 Monster Math 1.00 1
 Montezuma's Revenge 1
 Moon Bugs 2 Note 9
 Moonmist 1
 Moon Patrol 1
 Moptown Parade 1
 Mouser 1 (Cart. Basic)
 Mr. Cool 1
 Mr. Pixel' Paint Set 1
 Multimate 3.31 3
 Multiplan 1.10 , 2.01 1
 Murder By The Dozen ?
 Music Construction Set 1
 Music Studio 1
 My Calc ?
 My Letters, Numbers, and
 Words 1
 New Key 2
 NFL Challenge 3
 Nice Print 2
 Newsroom 1
 Newsroom Pro 2
 Night Mission Pinball 1
 Norton Commander ?
 Norton Utilities 1
 Numberworks 1
 Nutshell 2
 Oil's Well 1
 One-On-One 1
 One Dir 2
 Onside 1
 OO-Topos ?
 Or CAD 6 Note 8
 Orbiter Note 1
 Origami 1 (BASIC)
 Othello 1
 Pacman 1
 Pacgirl ?
 Paper Plane Construction Set
 Paper Models 1
 Paperback Writer ?

Paradox	6		
Pascal Compiler 1.00	2		
Pascal Compiler 2.00	2		
Partner	2		
Patton vs. Rommel	2		
Paul Whitehead Teaches Chess	2		
Print Buffer Online	1		
PC Boss	1		
PC Calc	2		
PC Check Manager	2		
PC Chess	?		
PC Desk	1		
PC Deskteam	1		
PC DOS Help	1		
PC File/Plus	1		
PC Font	1		
PC Globe	5		
PC Golf	?		
PC Graph	2		
PC Key Draw	2		
PC Ledger	?		
PC Man	1	Note	4
PC Menu	1		
PC Outline	1		
PC Paint V 1.50	2	Note	8
V 2.01	3	Note	8
PC Paintbrush	?	Note	8
PC Paint Plus	1		
PC Palette	1		
PC Plot	?		
PC Pool	1		
PC Pool Challenges	1		
PC Prompt	1		
PC Rail Road	2		
PC Speech	1		
PC Storyboard	1		
PC Stock	1		
PC Style	1		
PC TalkJR	1		
PC-TAX	2		
PC Tools	1		
PC Touch	1		
PC Trek	1		
PC Tutorial	?		
PC Type	1		
PC Window	1		
PC-Write V2.5	1		
PC Write V2.7	3		
Peachtree	?		
Peanut's Maze Marathon	1		
People Organizer	1		
Perfect Calc	?		
Perfect Score	1		
Perry Mason Games	1		
Personal Ancestral File	?		
Personal Communications Manager	1		
Personal Development	1		
Personal Editor 1.00	1		
Personal Lawyer - Wills	1		
PFS Calc	1		
File			
Report			
Write			
Professional Write	2		
Piece of Cake Math	1		
Pianoman	1		
Phaze Craze	1		
Pinball Construction Set	1		
Pinball Rally	?		
Pitstop II - Epyx	1		
PkxArc & PkxArcJR	1		
Planetfall	?		
Planners Choice	?		
Planning Assistant	1		
Players Choice	?		
Please	?		
Pocket APL	1		
Pockets Series	1		
Police Quest	1		
Pop Up Deskset	1		
Portal	2		
Power Base	2		
Print Master	1		
Print Master Plus	2		
Print Shop & Companion	1		
Print Works	1		
Printing Press	?		
Private Tutor 2.00	1		
Procomm	2		
Pro Design II	?		
Professional Editor 1.00	1		
Professional Connection	1		
Prokey 4.0	1		
ProXLoad	1		
PSI Trading Co.	?		
Q Basic Compiler	1		
Q Disk	1		
Qmodem JR	3		
QuickBasic 3.0 & 4.0	1		
Note	2		
Quick Key	1		
Quicken	2		
Racter/Ractor	1		
Rambo	2		

Reader Rabbit and the
 Word 2
 Factory 2
 Reflex 6 Note 1
 Reflex Point ?
 Reflex Workshop ?
 Rendezvous With Rama 1
 Reporting Assistant ?
 Rhymes & Riddles 1
 Risk Jr 1
 Robotron 1 Note 4
 Rocky's Boots 1
 Rogue 1
 Roots 1
 Running Program (Meca) ?
 Run for the Money 1
 Sailing 2
 Sargon II & III 1
 Scout ?
 Scorecast ?
 Script/PC 1.0 2
 Script/PC 1.1 2
 Script/PC II 3 Note 1
 Seek Easy ?
 Select-A-Font 1
 Seven Cities of Gold 1
 Shamus 1
 Shanghai 2
 Show Partner ?
 Sidekick 1
 Sideways 1
 Sign Master 1
 Silent Service 1
 Slide ?
 Sleuth ?
 Smart Com 1
 Smart Money 1
 Snack Attack 1
 Snake 1
 Snooper Troopers 1
 Snoopy's Reading Machine 1
 Solar Sim 1
 Solo Flight 1
 Song Writer 1
 Sorcerer 1
 Space Games 2
 Space Quest 2
 Spellicopter 1
 Spell It 1
 Spell Breaker 1
 Spelling Bee 1
 Spiderman 1
 Spitfire Ace 1
 Sportsman 1
 Spreadsheet Auditor 2
 Speed Reader II 1
 SQZ! 3
 Starcross 1
 Star Fleet I 1
 Star Flight 1 Note 2
 Stargate 3 Note 9
 Star Trek 3
 Stock Calc ?
 Story Machine (Spinaker)
 Note 9
 Strategy Games 1.05 1
 Study Mate 1
 Sub Battle 3
 Submarine Commander 1
 Submission 1
 Success With Algebra 1
 Super Boulderdash 1
 Superbowl Sunday ?
 SuperCalc 3&4 V2.1 2
 Superkey 1 Note 9
 Super Writer 1
 Swift Calc 1
 Sword Quest 1
 Sylvia Porter's Personal
 Finances ?
 Symphony 5 Note 2
 T-Modem 1
 Tass Times ?
 Tapper 1
 Teacher's Quiz Designer 1
 Tellstar II ?
 Telepaint 2
 Term Paper Writer 2
 3-D Chess 1
 3-D Helicopter Simulator 1
 Temple of Apshai Trilogy 1
 Textra 4.0 2
 Thexder 3 Note 7
 ThinkTank 2.0 1 Note 9
 Ticket to Paris 1
 Tigers in the Snow 1
 Time Manager 1.05 1
 Time Travel in History ?
 Tink Tonks ?
 TLC Lisp 1
 Touchdown Football 1
 Tournament Bridge 1
 Toy Shop 1
 Transylvania 1
 Traveling Sidekick 1
 Trinity 1

Trivia ?	Word Attack 1
Trivia 101 ?	Word Challenge 2
Trivia Fever 1	WordPerfect 2
Trivia Savant 1	Word Perfect Jr. 1
Trivial Pursuit ?	Word Perfect Library 2
Turbo BASIC 3 Note 2	Note 9
Turbo Chess 3	Word Processing for
Turbo Database Toolbox 3	Children 1
Turbo Editor 1	Word Proof 1.00 1
Turbo Gameworks 1	Word Writer ?
Turbo Graphic Toolbox ?	Wordix ?
Turbo Lightning ?	Wordstar 3.3 1
Turbo Pascal 1	Wordstar 4.0 2
Turbo Prolog 1	Work Force II 1
Turbo Tax 2	Workstation Manager 1
Turbo Tutor ?	World's Greatest Baseball 1
Turbo Word Wizard 1	World Karate Championship 1
Turtle Power 1.00 1	World's Greatest Baseball
TV and Cinema Trivia 101 1	Game 1
Twin 3 Note 1	Write and File 1
Twist and Shout 1	Write Right 2
Type! ?	Write It ?
Typing Made Easy 1	Writers Choice ?
Typing Tutor 1	Writing Assistant 1
Ultima I, II, III, and IV	Writing to Read 1 Note 6
2	X Talk ?
Ultra Utilities 2	XYWrite 2
Up and Add'em 1	Yahtzee ?
VisiCalc 1.20 1	Your Net Worth ?
Volkswriter 3 2	Zaxxon 1
Volkswriter Plus 2	ZBasic 3.01 1
Voodoo Island 1	Zork I, II, III 1
VP-Planner 1	Zyll 1
Info	
Webster's New World Speller	
2 (set to -wv=n)	
Thesaurus 2	
Writer 1	
Wheel of Fortune 1	
Where in the USA is Carmen	
S.D. 1 Note 2	
Where In the World Is Carmen	
S.D. 1	
Wilderness 1	
Will Writer 1	
Wines on Disk 1	
Winnie the Pooh 1	
Winter Games 1	
Wishbringer 1	
Witness 1	
Wizard of Wall Street 1	
Wizardry 1	

NOTES: _____

PCjr POWER SOFTWARE

Contained on the software disks are both programs and documentation for the programs. In this outline you will receive a overview of the programs operation, but you should look to the individual documentation file for the programming specifics.

To use the documentemtion for the individual programs you must place the PCjr POWER disk into your drive and at the prompt type;

A>DIR/W

this will print a directory of the diskette to the screen. You will notice the programs all have a filename with the extension of COM, EXE, or BAS. The documentation for the program is under the same filename but with the extension of DOC. To view the documentation file on the screen you would type;

A>LIST filename.DOC (enter)

ie; to see the documentation for the program ADKEYS you would type;

A>LIST ADKEYS.DOC (enter)

to copy this documentation file to a printer you would type;

A>COPY ADKEYS.DOC PRN (enter)

make sure your printer is turned on and you will receive a printout of the documentation file.

PROGRAMS ON THE DISKS

ASDKEYS.COM - is a key defination program designed to assign definations to the function keys, including F11 and F12 on 101 key keyboards. When run, the program stays resident in memory and the function key assignments can be turned off and on. Call the program by pressing CNTL + [. Start the program by typing;

A>ADKEYS (enter)

BIGD.EXE - is a directory listing program which will print out all sub-directories in easy to read form. Attention must be paid to the use of lower case and no puncuation marks on the command line. BIGD always looks for drive C if no drive specifier is given. Start the program by typing;

A>bigd [drive] or

A>bigd [drive] > prn (to send to the printer)

CFORMAT.COM - is a quick format program for formatting diskettes in one or two drives, with or without verification. To start the program which is also the documentation type;
A>CFORMAT (enter)

CHK4BOMB.EXE - is a program designed to check for dangerous virus type programs. Check all programs that you download from a bulletin board first. Start program by typing;
A>CHK4BOMB [filename] (enter)

COMSPEC.COM - assigns the location of the command processor to a location other than the default disk drive. The program is usually called from within the AUTOEXEC.BAT file see page 20 of the PCjr Power book.

CONFIGJR.DSK and NRD - are device driver files to setup many functions including, mode, number of drives, keyclick, capital letters, video page, ramdisk, and extended memory. Very useful programs. Documentation for the programs is 13 pages long. The syntax to call these programs in the config.sys file is;
DEVICE=CONFIGJR.DSK or NRD /switches

DEVASTE.BAS, PIECHART.BAS and SPIDER.BAS - are basic programs to illustrate the use of the basic language in programming. These programs require the basic cartridge. To start a program type; A>BASIC RUN"filename (enter). You can also list these programs to see the routines used to obtain the different program sections.

EZ.COM and EZDATA - is the Easy Dos program that can be invoked to expand the DOS commands. Documentation is in the file EZHELP.DOC and is 9 pages long. You must use the instruction to effectively use EZ.COM.

HOTDOS.COM - is a extra command interpreter that will suspend program operation to allow the use of DOS commands. NOTE: This program is for the advanced user.

HUSH.COM - is a program to assign to proper speed to drives when using DOS 3.X. Use this file in your AUTOEXEC.BAT file to automatically invoke the HUSH utility.

JET.COM - is a quick copying program that will copy all files on a diskette to another diskette. The DOS hidden files and COMMAND.COM will not be copied. The syntax is;
A>JET [source drive] [target drive] ie;
A>JET A: B: (enter)

JRCLICK.COM - is a utility program used to turn on the keyboard click in the Junior keyboard. Call this program in your AUTOEXEC.BAT file to turn the click on automatically.

LIST.COM - is the text file listing program. You used it to list the documentation files for the associated programs on this diskette. The program contains 16 pages of instructions.

PCBOSS.COM - is a DOS control program. Makes the common DOS commands easy to control. Pressing F1 brings up the internal documentation, and the setup screen is obtained by pressing ALT + S. This program is a must use utility for novice and pro.

PCCOLOR.COM - is a screen color program, setting the screen colors when the program is called. Use this program in your AUTOEXEC.BAT to set the screen colors most pleasing to you.

PCJRXTRA.SYS - is a device driver to make the Junior more compatible with standard PC software. The syntax for the config.sys file is; DEVICE=PCJRXTRA.SYS

PCWINDOW.COM - is a memory resident popup program which can be invoked by pressing ALT + 0 keys. This program contains a ASCII display, printer setup, timer, color/no color, and a notepad which can be used at anytime.

PGMSCOMP.DOC - is the text file list of compatible software that is listed in the book.

PKXARC and PKXARCJR.COM - are programs used in unarchiving compressed files as they are usually downloaded from bulletin boards or received from software sources. Read the documentation fully. PKXARCJR is a version that works well on most Juniors if PKXARC doesn't.

POPSIC.COM - is a great little memory resident program that performs DOS functions with the use of the arrow keys and the enter key. POPSETUP.COM is the setup program used to design the program to your tastes.

QDISK.COM - is a memory resident popup file manager program that is best used with a expanded memory. The ALT + TAB key call up the program. It uses approximately 11K bytes of memory to remain resident. Documentation is approximately 8 pages in length.

QUICKCAT.COM - is a diskette cataloging program. It will read a disk and intergrate the disk directory into a master catalog listing to help you locate programs throughout your diskette library.

RAM.SYS and SETRAM.EXE - are ramdisk device driver and program for starting the ramdisk while running. With this little program you can create a ramdisk on the fly. You can also delete it if you need that addition memory space for your applications.

SDIR.COM - a small sorted directory listing which outputs to the screen or printer in standard 4 column mode. The syntax for its use is as follows;

A>SDIR [drive]:/(switches)

Switches options are /C clear screen, /W write to printer, /P pause when page is full, /A show all files and directories, /2 /6 is output in columns, Sorting /No /Size /Date /eXt.

SPACE.COM - is a program to show space on the default drive or a drive denoted.

STATLIN.COM - is a program used in the AUTOEXEC.BAT to setup a status line on line 26 of the screen display which is below the normal work area. This program will display the capslock, numlock, scrollock, date and time. This file will automatically blank the screen after a user specified period. The documentation is contained in the CONFIGJR.DOC file.

SWAPCOM2.COM - is a program that exchanges the COM1 and COM2 port addresses stored in RAM memory if the PCjr internal modem is not installed. If the internal modem is installed it does nothing except issue a message.

TIGERKEY.EXE - is a function key setting program which stores the keypress information in a file and can be invoked from within the AUTOEXEC.BAT file on boot up.

ZANSI.SYS - is a very fast version of the ANSI.SYS device driver. It has a speed increase of approximately 25% over the normal ANSI driver. This increases the screen updating, screen printing functions. Remove the other ANSI drivers and call this in the config.sys file ie; DEVICE=ZANSI.SYS.

TANDY MODIFICATION PRECAUTIONS

The TANDY modification is easy to do but many people do not take the precautions against evils of **STATIC ELECTRICITY** that they should. They can end up with a damaged 74S86 chip or worst yet a damaged motherboard making a cheap installation very expensive.

Installation seems to go smoothly if the installer follows these few and simple rules:

- * Make sure to **UNPLUG ALL EQUIPMENT** from wall outlets.
- * Make sure that you are grounded before touching the PCjr or the Tandy Mod chip. (Use a grounding wrist strap)
- * Lift the feet from the floor and keep them up. (Put them up on the rungs of your chair)
- * Keep your fingers off of the 64 pin expansion buss pins on the right side of the computer.
- * Remove the internal memory card, disk controller card, disk drive and power supply, touch these internal cards only by their EDGES.
- * If you have a socketted 8088 chip remove it and set it aside. (Remember to replace it when the modification is complete)
- * Use only a low wattage soldering iron (25 watts is maximum).
- * Be sure that you are working in the correct area of the motherboard as per the orientation illustration.
- * Be sure to replace all parts back into the computer that you removed.

BUILDING A SERIAL PORT CARD FOR THE JUNIOR

(Experimenters Only)

These instructions should provide you with enough information to construct a card that provides an additional RS232 serial port for the PCjr. The card plugs into the internal modem slot. This gives the capability of running two serial devices, such as an external modem and a serial mouse, simultaneously.

Theory of Operation

The one RS232 port provided on the PCjr uses the 8250A asynchronous communications chip. The PCjr internal modem card also uses this chip. The idea is to build a card using an 8250A that provides the same external interfaces as the RS232 port on the system board. The 1488 line driver and 1489 line receiver chips perform this function. An additional chip, the LS245 octal bus transceiver, provides two-way buffering for the data bus connecting to the 8250A.

When this card is plugged into the internal modem slot, it becomes the COM1 port, addressed at 3F8. The system board RS232 port is COM2, addressed at 2F8. This is consistent with standard PC operation. A stock PCjr without the internal modem has the system board RS232 port designated as COM1, but the address is still 2F8. Some programs, especially communications software, have trouble dealing with this inconsistency. There will be no problem with this when this card is installed.

Parts List

1	INS8250A or INS8280AN Asynchronous Comm. Chip	Z1
1	74LS245 Octal Bus Transceiver	Z2
1	1488 or 75188 Quad Line Driver	Z3
1	1489 or 75189 Quad Line Receiver	Z4
1	40 pin DIP socket	
1	20 pin DIP socket	
2	14 pin DIP sockets	
1	Blank Card with edge connector	
1	4.7K 1/4 watt resistor	R1
2	10K 1/4 watt resistors	R2,R3
5	0.1 mf ceramic disc capacitors	C1-C5
1	DB-25 Male connector and metallic shield.	J1
2	inline male-female plug pairs.	
	30 gauge solid wire (wire wrap type)	
	24 gauge stranded wire	
	Aluminum foil	
	Electrical tape	

Notes on above parts:

There are 8250 chips, and there are 8250 chips. The original 8250 is used in the PC and has some known bugs that the PC and/or software corrects for. The 8250A corrects these bugs, for this project, use only the 8250A chip.

The LS245, 1488, and 1489 are common chips readily available at electronics stores. The 1488 and 1489 can be found at a Radio Shack.

The card is probably the most difficult part to find. This card found, at a local electronics store, that goes into an Apple. Its edge connector contacts were on the required 0.1 inch centers. The edge connector was longer than necessary, but it is a simple matter to trim it down. The whole card had to be trimmed also. This particular card had two metal strips going around the perimeter, which were handy for Ground and +5 Volt busses.

There are two wires that have to be connected to the card from the system unit because the required service is not available from the modem slot. So that the card can be removed, you will need some kind of INLINE connector for these wires. Use whatever works. Obviously, a dependable connection is very important.

These instructions should be sufficient enough that the PCjr Technical Reference is not required. If you have one, however, you will get a clearer idea of what is going on.

Preparing The Card

Do this first. If you have something that needs to be trimmed to fit, give some attention to how the card will be supported. I would not depend only on the modem slot for support. If you look directly to the rear from the modem slot, you will see a plastic cradle near the back panel. Your card may reach back that far; if not, attach a small "leg" to the back of the card so that it extends down to the system board and rests on it. Make the leg out of some spare perf board. **NOTE:** the two metal pins standing up from the system board just in front of the plastic cradle. Make sure these pins don't short to something on your card.

Now look at the underside of the PCjr cover panel. You will see some notches that the tops of all the cards fit into. If your card reaches back to the plastic cradle, it should also fit into the cover notch for a secure fit.

You may have to trim contacts off the edge connector. You need 30 contacts, 15 on each side. **NOW CHECK THE BOARD THOROUGHLY FOR SHORTS!**

Once everything is done, plug the card in and turn on the machine, just to make sure there are no shorts anywhere. The next step is placing the sockets and wiring them up.

SOCKET PLACEMENT (See Figure #1)

This drawing shows the placement of the sockets and chips on the card. This seemed to give the best wireability, at least as far as the 8 line data bus was concerned. If you look at the card as placed in the slot from the front of the machine, the chips should be on the left side, with the wiring on the right side. This arrangement matches the other cards in the unit. It is a good idea to orient all the chips the same way, so that you will know which is PIN #1 without constantly flopping the card over. DO NOT put chips into the sockets until all of the soldering is completed.

Make sure you allow sufficient margin at the top of the card to allow clearance where the card fits in the support notches on the PCjr cover panel.

WIRING(See Figure #2)

Using the 30 gauge wire and the schematic provided go ahead and start connecting things up. Start with the data bus from the LS245 to the edge connector, and from the 8250A to the LS245. From then on, the idea is to run wires in more or less north-south and east-west directions, putting right-angle curves in them where necessary, rather than stringing them directly between pins. The end result is a little neater looking, and gives some slack in case you find you connected to the wrong pin somewhere.

NOTE!: Do not connect pin B13 of the edge connector (J2) to ground yet. This is what tells the PCjr that a card is in the slot. What you should do periodically during the wiring process is put the card in the slot and see if the computer goes through POST okay. If B13 is grounded, POST will attempt to communicate with the card, and an ERROR E will result.

You will use the 24 gauge stranded wire to connect the card to the DB-25 (J1) connector. About 6 inch lengths should be sufficient. The drawing is correct in showing that only 9 PINS are used. Pin 1 of J1 is labeled SHIELD GROUND. After all the other wires were connected to J1, Strip about a foot of insulation off a piece of stranded wire. connect this to J1 pin 1, then wrapped it around the other wires all the way up to the card. Then, the resulting cable was wrapped in aluminum foil, and finally, electrical tape. A metallic DB-25 shield that contacts the foil completes the connector. To run the cable outside the machine, cut a 1/4 by 1/4 inch notch at the top of the back panel of the system unit. Or there is also some standard 9 conductor shielded cable that you can use to save you some effort here.

The other end of the shield wire was soldered to the metal shield over the display and serial jacks at the back of the system board. This was where one of the inline male-female plug pairs was used, so the card could be removed if necessary. It will probably be tempting to take a shortcut here and connect the shield wire to the signal ground on the card somewhere. This may work with no problems, let's assume that they keep signal ground and shield ground separate for some good reason.

There is one more connection that you have to make to the card. Pin 1 of IC 1488 (Z3) needs a -12 volt supply. This is not available at the modem slot. You can get this from pin 10 of the power supply card (that thing with all the heat sinks at the left side of the system unit). Pin 10 is the rearmost contact of the power card edge connector. There is a solder pad there that is easy to connect a wire to. The other inline male-female plug pair is used here. If you have a Technical Reference manual, be aware that there are several errors in it as far as the power card voltages are concerned. Most of the schematics show -6, but on most computers it is definitely -12.

The 0.1 pf capacitors should be mounted as physically close to their respective IC's as possible, so that minimum wire length connects them to the pins. I have found on other projects that these capacitors eliminate RF interference that can upset your TV picture.

Trying it Out

Once everything is wired and POST still works, you can connect J2 pin B13 to ground, and install the chips. The moment of truth has arrived. With the card in, the system should boot up with no problems. An ERROR E right after the memory counter stops and before the disk drive starts is a sign of a problem. No changes of any kind are required to DOS to get it to recognize the card.

If you attempt to run the modem test in the internal diagnostics (CTRL-ALT-INS), however, you will get a failure, even if your card is working correctly. This is because this test actually tries to run some internal modem functions.

NOTE: If you have to do a CTRL-ALT-DEL while the modem was active, an ERROR E will sometimes come up. Apparently this is caused by garbage coming from the modem rather than a hardware problem. Another CTRL-ALT-DEL is always successful.

That should complete this serial port project.

Front →

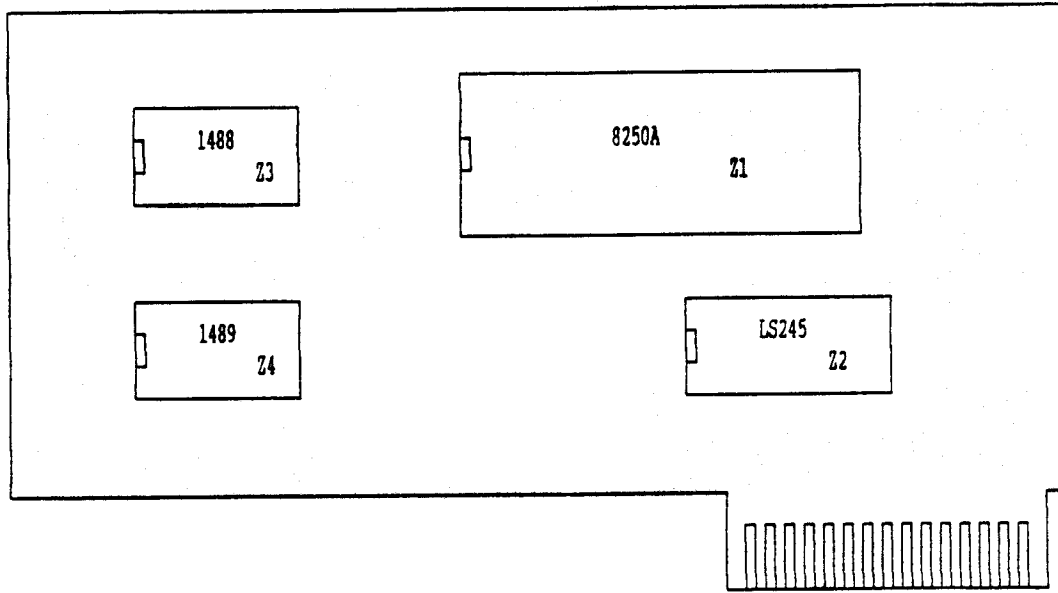

#1. PARTIAL SERIAL CARD LAYOUT

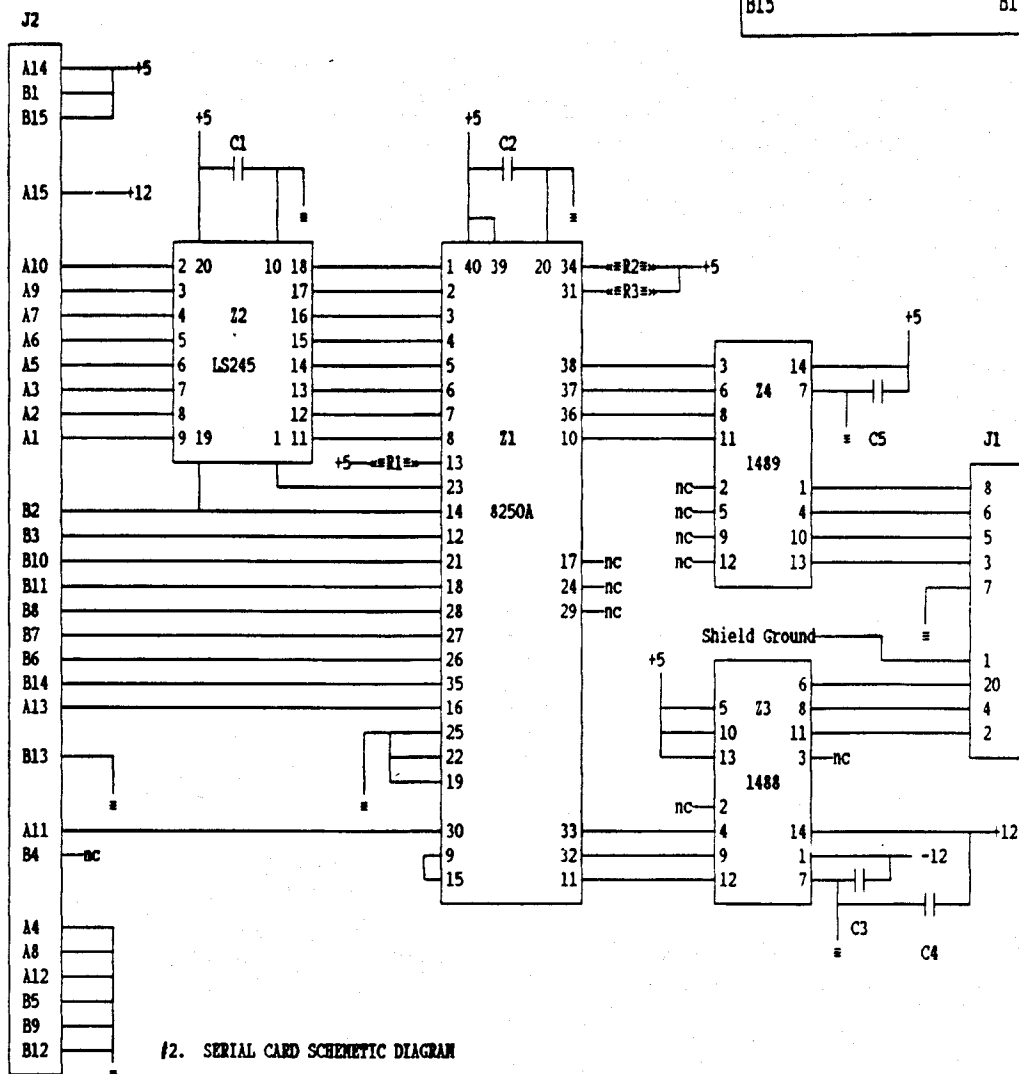
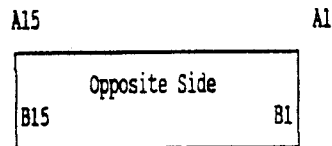

#2. SERIAL CARD SCHEMATIC DIAGRAM

SECOND DISK DRIVE 2

IBM PCjr DISK CONTROLLER BOARD MODIFICATION

TOP OF BOARD (COMPONENT SIDE)

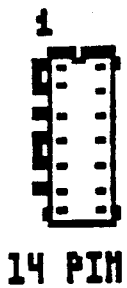
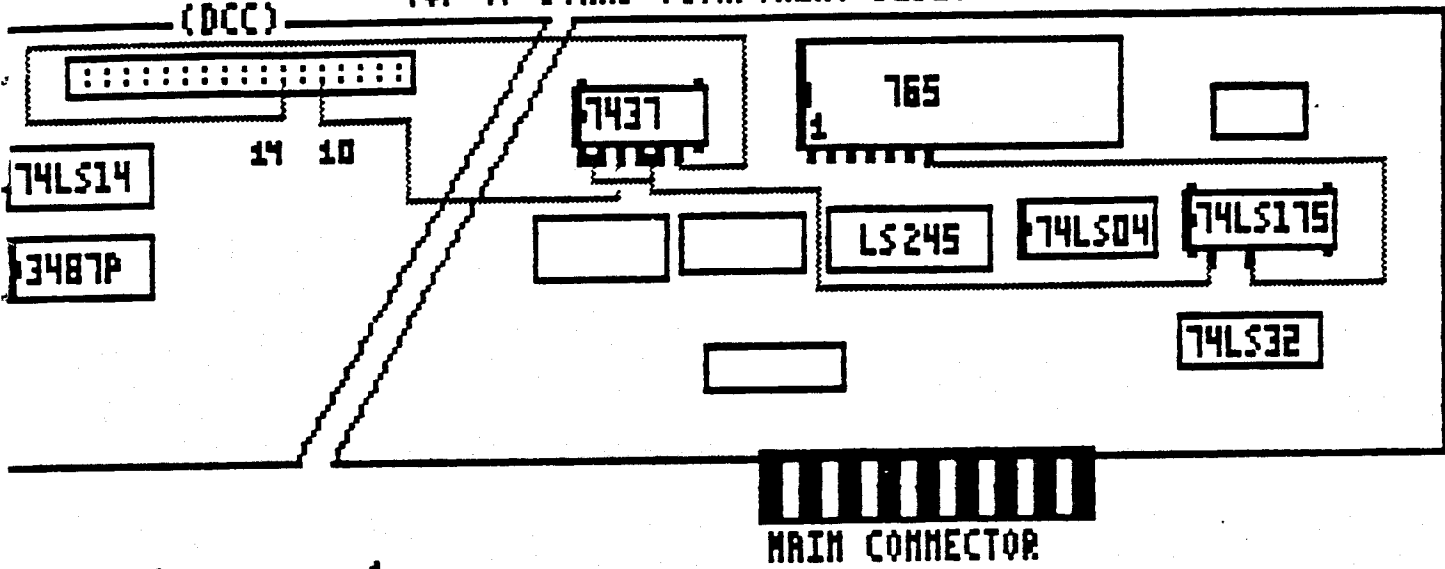

Sockets mount piggy-back on their host chips.
The 14 pin socket on the 74LS08 chip. The 16
pin socket on the 74LS175 chip.

DO NOT INSTALL THE CHIPS UNTIL ALL SOLDERING IS COMPLETE.

WIRING SCHEDULE FOR CONTROLLER MODIFICATION:

FROM THE SOCKET ON THE	TO THE SOCKET ON THE
74LS08 Pins 4 and 5	74LS08 Pins 1 and 2
74LS08 Pins 4 and 5	74LS175 Pin 2
74LS08 Pin 3	DCC Pin 10
74LS08 Pin 6	DCC Pin 14
74LS175 Pin 4	765 Pin 7

NOTE: All wiring is done between the added piggy-back sockets or between the piggy-back socket and a existing location on the board.

DISK CONTROLLER CARD MODIFICATION FOR SECOND DISK DRIVE

Remember to carefully read all instruction for this change before beginning the actual work. This modification DOES NOT run both drive motors at the same time so it will work with a second drive with or without additional power supply. The additional power supply is recommended with 5 1/4" drives since they do draw more power.

USE ONLY A LOW WATTAGE SOLDERING IRON. Please, if you do not understand the principles of soldering on printed circuit boards seek out knowledgeable assistance; such as a local users group, electronic technician or amateur radio operator (HAM) to help you with this facet of the modification.

GETTING STARTED

You will need the following parts to make this modification;

	1	74LS175 16 pin chip
*	1	7437 14 pin chip (cut off pin 8)
	1	14 pin socket (modified per illust.)
	1	16 pin socket (modified per illust.)
	1	34 conductor 2 drive cable
	2 feet	#28 tinned copper wirewrap wire
	1	Software diskette for 2 disk drives

You will need the following tools for this modification;

1	Wire strippers
1	Low wattage soldering iron
1	Desoldering tool or solder wick
1	Screwdriver
1	Neddle nosed pliers (small)
1	Diagonal cutters (small)
1	Soldering tool or dental pick
1	Magnifying glass
Solder	Fine wire, rosin core

It is important to have good lighting for this work. Shut off power to your PCjr and allow it to cool. Unplug the power cables form the wall sockets. Remove all cable connections from the rear of your junior. Using a flatblade screwdriver, pry up the top cover from the rear and remove it. Locate your disk drive controller board with the wide flat cable connecting it to the rear of the disk drive. Disconnect the cable from the disk drive and carefully lift out the controller board. Remove the flat cable from the controller board and set it aside. Place your controller board on a clean work surface with the COMPONENT SIDE UP. The controller board should be oriented as in the enclosed controller diagram, with the 74LS175 chip to your right.

BOARD PREPARATIONS

Locate pins 10 and 14 of the disk controller cable connector (DCC). Looking at the component side of the board, pin 10 is the 5th pin and pin 14 is the 7th pin both from the right on the lower row of pins. (see diagram) With a marking pencil mark the location of these pins on the reverse (trace) side of the board for later identification.

Modify the chip sockets as follows, locate the pin 1 end (notch) of the 16 pin socket. Bend up pins 2, and 4 and cut off pins 3,5,6 and 7 and pins 10 through 15. This leaves pins 1,8,9 and 16 in their normal positions. Locate the pin 1 end of the 14 pin socket and bend up pins 1,2,3,4,5, and 6. Bend together pins 1 and 2 and pins 4 and 5 so they short together. Cut off pins 9 through 13. Leave pins 7,8 and 14 in their normal position. (see diagram)

Locate the 74LS175 chip on the board. With the soldering iron and solder, tin pins 1,8,9 and 16. Orient the 16 pin socket over the 74LS175. The notched end of the socket over the notched end of the 74LS175. Solder the socket pins (1,8,9 & 16) to the same chip pins below it. Tin the remaining bent up pins.

Locate the 74LS08 chip on the board. With the soldering iron and solder, tin pins 7,8 and 14. Take the 14 pin socket provided and orient it over the 74LS08. The notched end of the socket over the notched end of the 74LS08. Solder the three socket pins (7,8 & 14) to the same chip pins below it. Tin the remaining bent up pins. SOLDER SHORT pins 1 and 2 and pins 4 and 5 together on this socket. (see diagram)

Before we proceed with the wiring lets check the board for good solder connections at the pins of the piggyback sockets. Use a magnifying glass and make sure there are no solder shorts to other chip pins.

PAGE A9 of the updates, the last paragraph should read -

STARTING THE WIRING

Study the wiring schedule and the diagram to place the wires. Begin with pins 4 and 5 of the socket mounted on the 74LS08. With the wirewrap wire, about 2" from the end strip a 1/4" gap in the insulation. Bend the 1/4" of wire showing in the gap completely in half and solder it to pins 4 and 5. Strip and solder the short end of the wire to pins 1 and 2. Route the other end to pin 2 of the socket on the 74LS175 and cut off the excess and solder this end to pin 2. Solder a wire from pin 3 of the 14 pin socket to pin 10 of the DCC connector on the reverse (trace) side of the board. Solder a wire from pin 6 of the 14 pin socket to pin 14 of the DCC connector on the reverse (trace) side of the board. Solder a wire from pin 4 of the 16 pin socket to pin 7 of the 40 pin 765 chip. (see diagram).

(HIGHLIGHTED ITEMS ARE CORRECTED)

When your wiring is complete, again check the board for good solder connections and solder shorts. Route and dress the wires neatly and place them down close to the surface of the board.

FINISHING UP

- * Install the chips into the piggyback sockets. The 7437 chip with pin 8 removed mounts over the 74LS08 chip with the pin 1 end nearest the notch end. The 74LS175 mounts into the remaining socket. Pin 1, the notched end of the chip, over the notched end of the socket. Make sure all chip pins are fit into the socket holes.

Attach the new 2 drive cable to the modified controller card as the old cable was attached. (see diagram last page) Carefully reinsert the controller card into the main board and attach the 2 drive cable to the internal disk drive. Route the cable out of the right side of the junior through the notched area. Make sure that the internal drive select jumpers for both drives are in the "B" position. (Some drives jumper labeling begins with DS0 position - then B is the DS1 position. If the jumpers begin with DS1 - then B is the DS2 position. Be sure to remove the second drive termination resistor pack). If you are using a "Y" splitter you must attach it to the internal drive power cable, the internal drive and out to the external drive. Replace the computer top being careful not to pinch the 2 drive cable or power splitter cable.

On drives with additional power supplies, plug in the second disk drive power cable and turn it on at the switch. Plug in your PCjr components and insert your new SOFTWARE disk. Turn on your PCjr and boot-up.

- * *** NOTE:** If you are making a modification for three disk drives read the instructions before cutting off any chip or socket parts.

DEBUGGING TIPS

If, when testing your drive modification you receive a **ERROR H** message at the opening diagnostic screen then you must check your modification in a **SYSTEMATIC** manner to help track down the error.

1. First check the disk drive select jumpers. Drive A (internal) should be in the "B" position. Drive B (external) should be in the "B" position.
2. Check the cable **POLARITY** at all three connection points. The controller card, drive A and drive B.
3. Check the addon chip **POLARITY** confirming that pin 1 of the add on is over pin 1 of the host chip.
4. Check all wiring connection. Look for solder shorts to other points, broken wires or wire connections or other problem areas.
5. If you use a second drive of your own, make sure the **RESISTOR PACK** was removed from this new drive.

If you received a **ERROR B** this indicates a keyboard problem.

1. Make sure your keyboard cable is plugged into the "K" slot at the rear of your junior.
2. If using batteries in your keyboard make sure they are good.
3. Check the alignment of the internal infra-red detector which may have been misaligned during the removal or installation of your controller card.

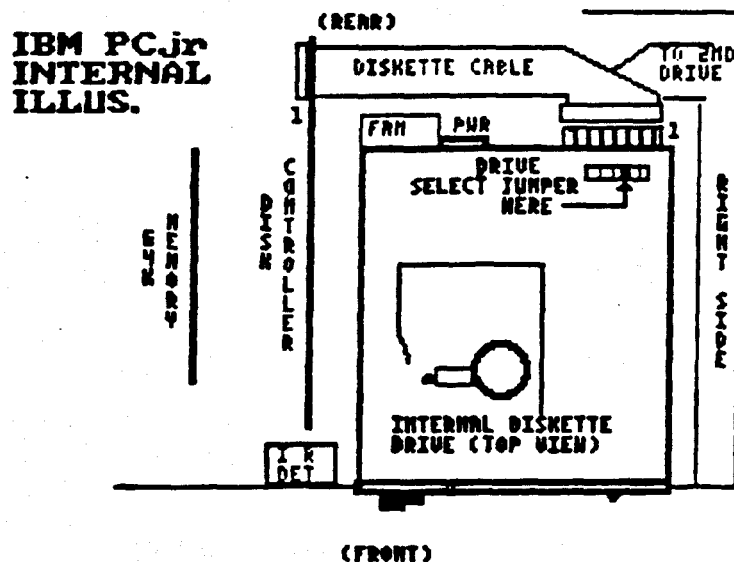

THIRD DISK DRIVE IBM PCjr DISK CONTROLLER BOARD MODIFICATION

TOP OF BOARD (COMPONENT SIDE)

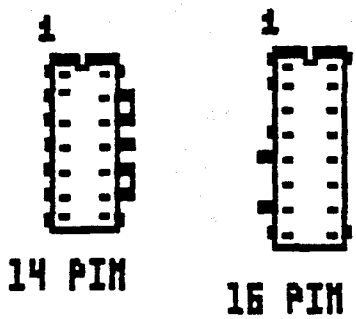
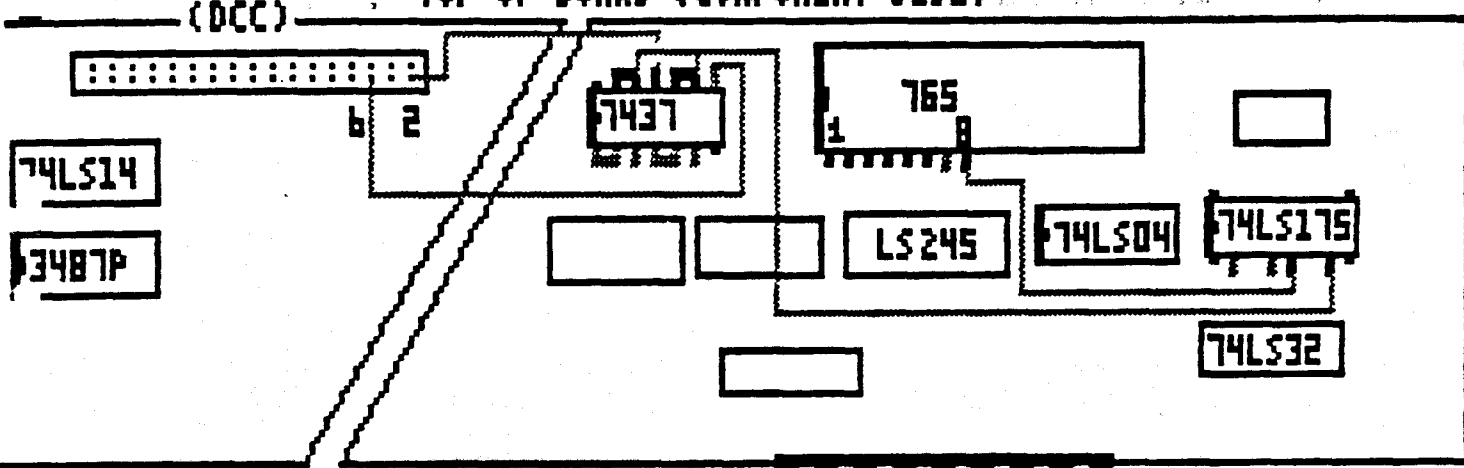

This wiring chart is in addition to the 2 disk drive wiring chart. Wire the 2 drive modification then wire this modification.

DO NOT INSTALL THE CHIPS UNTIL ALL SOLDERING IS COMPLETE.

WIRING SCHEDULE FOR 3rd DRIVE CONTROLLER MODIFICATION:

FROM THE SOCKET ON THE	TO THE SOCKET ON THE
74LS08 Pins 9 and 10	74LS08 Pins 12 and 13
74LS08 Pins 9 and 10	74LS175 Pin 7
74LS08 Pin 11	DCC Pin 2
*7437 Pin 8 (BENT UP)	DCC Pin 6
74LS175 Pin 5	765 Pin 8

NOTE: All wiring is done between the added piggy-back sockets or between the piggy-back socket and a existing location on the board, EXCEPT PIN 8 OF THE 7437 CHIP IS BENT UP AND WIRED TO DCC PIN 6.

DISK CONTROLLER MODIFICATION-ADDING A 3RD DISK DRIVE

Remember to carefully read all instruction for this change before beginning the actual work. This modification DOES NOT run the drive motors at the same time so it will work with a second and/or third drive with or without an additional power supply. With 3 disk drives, however, and additional power supply is always recommended.

USE ONLY A LOW WATTAGE SOLDERING IRON. Please, if you do not understand the principles of soldering on printed circuit boards seek out knowledgeable assistance; such as a local users group, electronic technician or amateur radio operator (HAM) to help you with this facet of the modification.

GETTING STARTED

You will need to use the same parts as in the two drive modification with additional modification.

You will need the same tools as indicated in the two drive modification.

It is important to have good lighting for this work.

BOARD PREPARATIONS

This modification is IN ADDITION to the second disk drive modification, made to the same sockets and chips. No additional parts are needed.

Locate pins 2 and 6 of the disk controller cable connector (DCC). Looking at the component side of the board, pin 2 is the first pin and pin 6 is the third pin counted from the right end on the lower row of pins. (See diagram) With a marking pencil mark the location of these pins on the reverse (trace) side of the board for later identification.

Modify the chip sockets as follows, locate the pin 1 end (notch) of the 16 pin socket. Bend up pins 5, and 7 and cut off pins 3 and 6 and pins 10 through 15. This leaves pins 1,8,9 and 16 in their normal positions. Locate the pin 1 end of the 14 pin socket bend up pins 9,10,11,12 and 13. Bend together pins 9 and 10, and 12 and 13 so that each pair short together. Leave pins 7,8 and 14 in their normal position. (see diagram) ** On the 7437 chip bend up pin 8 do not cut it off, we will attach a wire to it later.

WIRING THE BOARD FOR THE THIRD DRIVE

Study the wiring schedule and the diagram to place the wires. Begin with pins 9 and 10 of the socket mounted on the 74LS08. About 2" from the end of the wire strip a 1/4" gap in the insulation. Bend the 1/4" of wire showing completely in half and solder it to pins 9 and 10. Strip and solder the short end of the wire to pins 12 and 13. Route the other end to pin 7 of the socket on the 74LS175 and cut off the excess wire and solder this end to pin 7. Solder a wire from pin 5 of the 16 pin socket to pin 8 of the 765 chip. Solder a wire from pin 11 of the 14 pin socket to pin 2 of the DCC connector on the reverse (trace) side of the board. Put the 7437 chip into the socket with pin 8 bent up so it is outside of the socket. Solder a wire from pin 8 of the 7437 chip to pin 6 of the DCC connector on the reverse (trace) side of the board. (See illustration)

When your wiring is complete, again check the board for good solder connections and solder shorts. Route and dress the wires neatly and place them down close to the surface of the board. Follow the instructions for adding a third drive connector to the flat cable.

**TWO DISK DRIVE CABLE
36" MINIMUM**

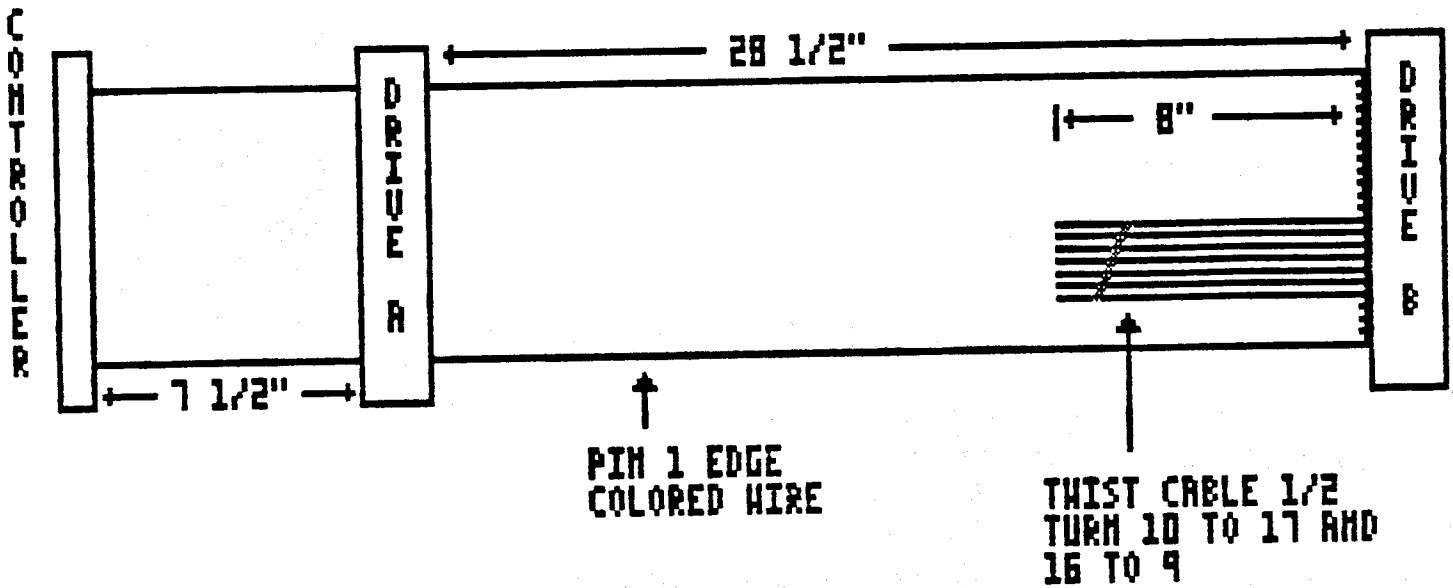

ADD THIS EXTRA CONNECTOR TO DRIVE CABLE FOR THIRD DISK DRIVE

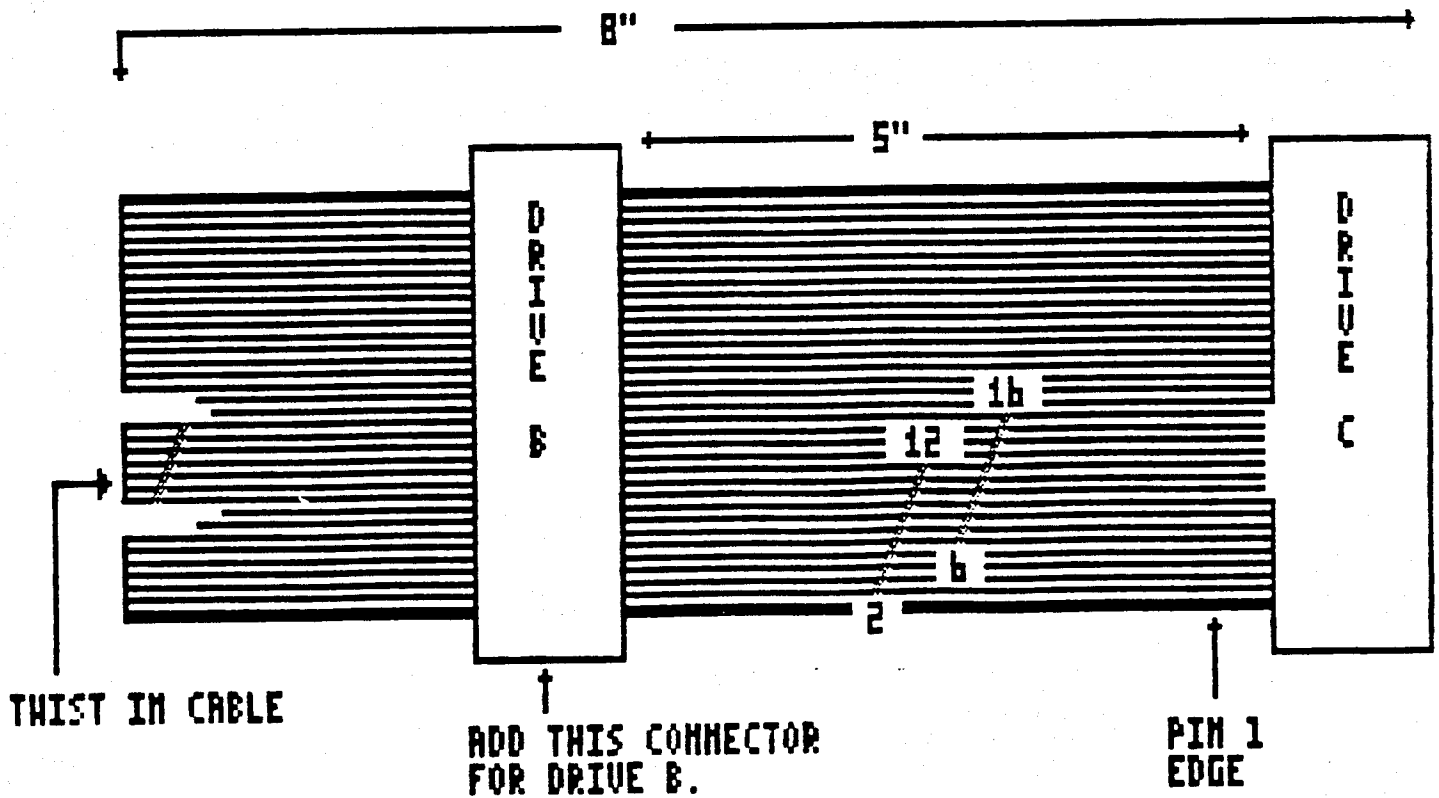

MAKING A NEW SECOND DISK DRIVE CABLE

If you are modifying the disk controller card to run two disk drives you must make a cable to attach to the two drives.

PARTS NEEDED

1	34 pin ribbon cable socket IDS-34
2	34 pin ribbon cable edge card IDE-34
36"	34 conductor ribbon cable (36" is minimum)
	Scotch or Masking tape

TOOLS NEEDED

1	Aviation or tin snips
1	Vice with padded jaws
1	Xacto Knife

Make sure to cut the ribbon cable ends at right angles to the cable, use tin or aviation snips to make a good clean cut. Look at the three connectors closely and you will note pin 1 is usually marked by a arrow placed on the connector. The ribbon cable is marked on one edge with a color different than the color of the main cable usually a red or blue edge.

You can pad the jaws of a vice with a couple of strips of leather or other similar material, attached to the jaws with double backed tape. This will not allow the vice jaws to cut into the plastic connectors.

Install the socket connector end first, this is the connector that will attach to the controller card. Slide the ribbon cable through the connector placing pin 1 of the connector over the pin 1 indicator (colored) edge of the cable. Line up the cable flush with the end of the connector and make sure that the connector is at right angles to the cable. (See your old cable) Press the two halves of the connector together forcing the pins slightly into the cable. Holding the connector and cable, slide the connector into the jaws of a padded vice. Slowly tighten the vice until the connector is seated. Do not overtighten the vice and cause damage to the connector. You can usually hear the connector snap together and no more tightening is needed at that time.

Now look at the old cable and note that the edge card connector is installed facing the opposite direction from the socket connector. Lay the cable down with the socket connector positioned with the holes DOWN. Measure seven and a half inches from the socket connector end of the cable and install the first edge card connector contacts up and pin 1 to the colored edge of the cable. Follow the same procedure using the vice for the correct clamping of the connector to the cable. (See illustration)

The last connector is attached to the other end of the cable facing the same direction as the first edge card connector. With the cable laid flat count over nine (9) wires from the pin one (colored) edge on the cable. With a xacto knife cut the edge of the cable between wires nine and ten. Continue to count over to wire sixteen (16) and with the xacto knife cut the edge between wires 16 and 17. Split the cable back eight inches at each notch. This will give the section of the cable wires, 10 through 16, which must be turned one half turn. Wire 10 should end up next to wire 17 and wire 16 will be next to wire 9. Align the cable sections as though it were again one cable and tape all three sections side by side with a piece of scotch tape about one half inch from the end. Put the last edge card connector onto this cable end and, making sure of the cable alignment, affix the connector as above. (See illustration)

Look at how the original cable was folded and you can make that same 45 degree fold in the new cable near the internal disk drive connector. Make another 45 degree fold in the end going to the second disk drive.

ADDING A THIRD DRIVE CONNECTOR TO THE CABLE

PARTS NEEDED

- 1 34 pin ribbon cable edge card IDE-34
- 1 Roll of plastic electrical tape

TOOLS NEEDED

- 1 Soldering iron

With the above cable made and tested you can add the connector for the third disk drive as follows.

Lay the cable down flat with the last connector that was attached to your right and pin 1 edge of the cable nearest you. Measure back up the cable five inches from this last connector. Make sure that the twist you put in the cable is closest to the main cable, all the way to the left of the splits. (See illustration) Add the third connector to the cable at the five inch mark in the same direction as the other edge card connectors. (See illustration) This new connector is now for drive B and the end connector will be for drive C.

Within the five inch segment between the last two connectors locate wire 2. With the xacto knife cut between wire 1 and 2 and between wire 2 and 3. Separate a one inch section on either side of wire 2. Locate wires 6, 12 and 16 and separate them out from the main cable just as wire 2 was done. Cut wires 2 and 6 nearest the right end cable connector. Cut wires 12 and 16 nearest the middle cable connector. Strip and tin a quarter inch end of each of the four wires.

Solder wire 2 to wire 12 and wire 6 to wire 16. Cover all bare wire ends with plastic electrical tape leaving no bare wire end exposed to short to the case or to the disk drives. (See illustration)

You can attach the new cable to the internal disk drive and to two external drives. This makes physical drives A,B and C. Using the DOS version 3.2 or 3.3 driver.sys file you may setup, format and copy between the types of drives that you have installed into you system. Using the JRCONFIG programs contained on the PCjr Power diskettes will tell the computer that you have attached either two or three disk drives to your system.

A few of examples of using the these files to setup the new enviroment for multiple drives in your configuration system (CONFIG.SYS) file might be as follows.

Example (1) CONFIG.SYS for 2 - 5 1/4" drives;

```
device = jrconfig.nrd -d2 -t3
device = ansi.sys
break = on
```

Example (2) CONFIG.SYS for 3 - 5 1/4" drives;

```
device = jrconfig.nrd -d3 -t3
device = ansi.sys
break = on
```

Example (3) CONFIG.SYS for 2 - 5 1/4", 1 - 3.5" drives;

```
device = jrconfig.nrd -d3 -t3
device = driver.sys /d:2 /f:2
device = ansi.sys
break = on
```

In each instance the first line is used to tell the computer the number of drives present and to start in the 80 column mode. (See the instructions for using the JRCONFIG programs) In the last instance the DRIVER.SYS device driver is used to indicate that drive C is a 3.5" 720K drive. This will allow diskettes to be formatted to the correct capacity. These examples illustrate the very simplest forms of configuration setups. Any number of variations my be used to acheive the correct environment for your individual use.

IBM PCjr PARTS AND PART NUMBERS - CONTINUED

FINAL ASSEMBLY:

System unit case bottom/front	8286007
System unit case top cover	8286006
System unit right side cover	8285994
Power transformer	8286003
Keyboard (new style)	6135725
Disk drive face plate (covers empty drive opening)	8285995
Plug protectors (J1/J2 connector guides)	6447163

SIDECARS:

Power Expansion Attachment	6135680
Parallel Printer Attachment	8285987X
128 Kb Memory Attachment	6135679X
Speech Attachment	6135678X
Cluster Attachment	6323471

INTERNAL ELECTRONICS:

Internal modem card - 300 baud	8654400
Infra-red receiver module	8654226

ATTACHMENTS:

Modem cable (modular phone jacks)	8285985
Connector for television	8285989
Cassette adapter cable	8285992
Service plug 1503441 (included with HMS manual)	6447196
POST-loop plug 1503442 (included with HMS manual)	6447197
Serial wrap plug 1503443 (included with HMS manual)	6447198
Parallel printer wrap plug (included with HMS manual)	72X8546
Cluster Cable Kit	1501207
Cluster Cable terminator plug	6323481

DISK DRIVE ASSEMBLY:

Disk drive unit (QumeTrak 142 or equivalent)	8285997X
Disk drive signal cable (34 conductor flat)	8285986
Disk drive power cable (4 conductor)	8285984
Disk drive mounting bracket	8286005
Disk drive mounting parts kit	6448933
Disk drive fan assembly	8285982
Disk drive rubber belt (Qume)	8285998

NOTE: A "X" after the part number indicates the part is available on a EXCHANGE basis.

PCjr DIAGNOSTICS OUTLINE

This table outlines the common problems encountered on the PCjr computer. Its source is the PCjr Diagnostics Manual with some additional information added.

POST Error	Problem Area	Probable Cause
No beep. No image or wrong image on screen	Power	Power board or System board
One beep. No image or wrong image on screen	Display	System board or 64K memory and display expansion.
Two beeps. No image or wrong image on screen.	Power	Power board or System board
Three beeps. No image or wrong image on screen	Memory	64K memory and Display Expansion
No Beep. ERROR 0AXX	Memory	System board
No Beep. ERROR 0BXX	Memory	64K Memory and Display Expansion (ERROR A)
No Beep. ERROR 0CXX	Memory	64K Memory and Display Expansion (ERROR A)
No Beep. ERROR 1YXX	Memory	System Board
No Beep. ERROR 2000	Keyboard	Keyboard (ERROR B)
No Beep. ERROR 21XX	Infra-red	Infra-red receiver
No Beep. ERROR 2200	Keyboard	Keyboard (ERROR B)
No beep. or Serial	Cassette	System Board
No Beep. ERROR 24XX	Modem	Internal Modem
No Beep. ERROR 25XX	Cartridge	
No Beep. ERROR 26XX	Diskette drive	Diskette drive adapter (ERROR H)
Advanced POST, or portion of it goes into loop.	System Board	System board, Error 23XX
Any ERROR message not listed in this table	Service plug	Ensure that service plug is good and installed correctly. Repeat advanced POST. If same message, replace system board.

COMMON REPAIR PROBLEMS TO THE PC JUNIOR

In the event that your junior is totally dead, don't simply replace the fuse on the power card and put the board back into the junior to test. Rather, test the power board first by connecting the power cable and fan to the power board out of its socket on the mother board. If anything is shorted on the card the fuse will blow again. The indicator will be the fan. The running fan will show that the fuse is good and that the +5 volt supply does not have a shorted regulator. A shorted regulator darlington transistor on the 7" power card will cause the +5 volt supply to go to about +20 volts momentarily until the crowbar circuit blows the 5 amp fuse on the card. This momentary voltage surge can destroy any number of memory chips within the junior.

Experience shows that the majority of the 2 BEEP errors as well as the 3 BEEP error, no beeps and generally the A and B errors, are all symptoms attributable to the 64K memory chips on the mother board or on the 64K plug-in memory card. To confirm a rough location of problem, strip the junior down to raw mother board with only the power card in place. Attach only the monitor. Keyboard can be infra-red or cable. If the infra-red receiver is removed then the cable MUST be plugged into the computer or you will get a 2 BEEP error for this reason. If junior starts normally then add each removed options one at a time to pin down the problem.

When problem is confirmed to be the mother board the following technique can be used in MOST cases although definitely not in all. NOTE: This method also works with the 64K plug-in card. Memory sidecar problems can be solved with this method, but a great deal more care is required.

As a preliminary step, leave power on in the failing system for about 15 minutes. Using a finger check, look for any excessively hot memory chip. A warmer than usual chip indicates a shorted condition and that chip needs to be replaced. If all memory chips appear normal then proceed.

1. For testing purposes, a known good chip of 200 nano-seconds or better can be used. I.E. 200ns, 150ns etc. The test chip should of the same memory size as the chip being tested. That is don't use a 256K chip across a 64K chip. (When a defective chip is found however, it should be replaced by a 150 nano-second or better chip of the same size to preserve the original circuit specifications).
2. Form the leads using a straight edge for a friction fit when piggy-backed on top of another chip.
3. Locate the eight 64K memory chips on the mother board. They are in the left front corner in line with the internal power supply card.

4. This procedure is easier if you have or can borrow the older design 7" power supply card. The 11" card gets in the way.

5. With power off (NOTE: there are no dangerous voltages in this area) piggy-back one of the eight chips being careful to align the sixteen pins as close as possible to those on the original chip. Make sure that the orientation of pin one, the notched end, match that of the piggy-backed chip.

6. For insurance gently hold the piggy-backed chip in position with one finger and turn on power to Junior. Wait for a indication.

7. If the error indication is still present, power down and move on to the next chip in the line.

8. If the junior comes up normally, you now know which memory chip must be replaced.

If after the first pass you don't find a bad chip then repeat the process on the chance that you might have had a bad connection.

If you suspect more than one chip is at fault, you can carefully piggyback all eight chips with known good chips and repeat the test. If the junior then works, you can remove one chip at a time to isolate the chips needing replacement. On one 64K card as many as four bad chips have been located in this way. The darlington regulator chip on the 7" power card had shorted causing a +20 volt spike on the +5 volt line before the fuse blew. The result was one blown chip on the mother board and four on the 64K card.

If you are confident that your problem is not a memory chip and you have not reworked the mother board in any way, then your best bet at this point is to seek a replacement mother board.

In one other case the problem did not indicate beeps but the color monitor screen turned green. That turned out to be a bad gate array chip. There are about three non-available chips on the mother board. The gate array chip and the two BIOS ROM chips. When any of these are bad the only recourse is to exchange the board with IBM provided that the board has not been altered.

PCjr MONITOR PROBLEMS

You should only use this information if you are qualified and have experience in servicing this type of equipment. **CARELESSNESS WITHIN THE MONITOR ENCLOSURE CAN BE FATAL.**

The second most common failure of junior monitor (other than the smearing problem listed earlier) is failure of the horizontal output transistor Q502 type 2SD1426. It can be replaced with ECG2302 available locally for approximately \$6.10 or a SK9422 at approximately \$6.33.

The symptoms are no picture, no sound from speaker, a high pitch squeal from chassis, and a burning smell after half a minute. Unplug the unit- Q502 (2SD1426) and R524 a 10 ohm 10 watt resistor will be too hot to touch. **NOTE:** the green on indicator light will work normally. Replace transistor to confirm repair. If symptoms persist after replacing transistor, then most likely the flyback transformer is shorted. The part number is 334-P-12101 (T503). Available from manufacturer, the cost at last estimate was \$92.00.

The third problem is uncontrollable vertical rolling. This problem has been traced to a defective C402 a 1.0 mfd at 35v polarized tantalum capacitor located off pin 10 of IC-401, the vertical/horizontal oscillator chip. It is in a rather difficult location to get at and in order to solder in a replacement you must remove the two bottom shields. The metal shield is removed by unsoldering one ground wire and then pushing up on the two plastic wire retaining posts at the front of the monitor. The copper shield is then removed by gently prying the three plastic press in studs. Closing the barbs of these studs from the component side helps greatly.

The fourth problem is cold or broken solder joints in two areas. The first area to check is the joints securing the metal shield on the video board which is mounted on the neck of the picture tube. Symptoms range from no picture to flashing in any color. The second area to check involves removing the two shields from the bottom of the main board. The cold joints are generally located on the horizontal output transformer side near the front. Symptoms are generally intermittent picture and/or high voltage.

Other problem seen in only two sets was brightness variations affecting all three colors equally for the first one to five minutes of operation. After that the picture was fine. Problem was traced to an intermittent screen voltage divider in the high voltage flyback transformer. Replacing the transformer solved the problem. Generally due to the expense as mentioned above, this was considered as not worth repairing.

The PC Convertible RGB Color Monitor Model 5145 was made by Samsung of Korea. No model number or schematic is available in the Convertible technical reference manual.

The two types of monitors are 100% plug and function compatible. That is either can be used with the Junior the Convertible. Both have internal speakers and a volume control, although the range and quality of sound on the Junior is much better due to use of an amplifier. The Convertible speaker is across the earphone jack and max volume is marginal.

The resolution of the Junior monitor is superior to the Convertible monitor. Both have slot mask picture tubes, but the beam width of the red, blue and green guns of the Convertible is too wide, or uneven between the three colors causing an effect which appears as misconvergence but in fact it is not correctable by convergence adjustments.

MONITOR DATA

PCjr RGB Color Monitor Model 4863 was made by Mitsubishi Electric Corp. and is identical sans case, speaker amp and PC cable to their Model AT-1332A. The service manual is available by writing:

Mitsubishi Elect. Corp.
991 Knox st.
Torrance, Ca. 90502
(213) 515-3993

FOR PARTS- Service Concept International
(714) 836-4981

Do not ask for a Junior monitor manual, they do not support IBM products. The price is \$25.00 for the complete manual, plus \$4.00 shipping UPS ground service. Additional charges for C.O.D. if you don't prepay. (LIST/RETAIL may be higher.)

They will sell copies of the schematic and parts list on request for less, and send it to you C.O.D. The service manual you will get is a poor copy of a printed manual. The schematic is barely readable but they claim it's the best they have.

SOFTWARE PATCHES

F19 PATCHES FOR SOUND AND VIDEO

Microprose F19 Stealth program does not support the PCjr "out of the box" but must be patched to fix graphics mode initialization and enable sound. A previously noted fix for the graphics init problem was to use the JRHOTKEY program - these fixes remove that need.

There are 4 fixes described:

1. Enable CGA 4-color mode and PC timer/beeper sound on a PCjr.
2. Enable Tandy 16-color mode on a PCjr WITH TANDY 1000 MODIFICATION!
3. Enable Tandy 3-voice sound on a PCjr in Tandy 16-color mode.
4. Swapping Tandy/IBM PC sound modes with 16-color/4-color modes.

FIX 1: CGA 4-Color Mode and IBM PC Sound

The following fixes both sound and video problems in CGA 4-color mode, using DOS DEBUG (caused by incorrect use of Port 61):

```
RENAME ISOUND.EXE *.EXX      (backup the original)
DEBUG ISOUND.EXX
-E B33 10                    (original data is 4C)
-W
-Q
RENAME ISOUND.EXX *.EXE
```

NOTE: This now a PCjr version only - not for regular PC's!

FIX 2: Tandy 16-Color Mode

Fix for sound and video problems in TANDY MODE (16-color), caused by incorrect use of Ports 3D8/A, and BIOS Bug:

```
RENAME TGRAPHIC.EXE *.EXX    (backup the original)
DEBUG TGRAPHIC.EXX
-E 21A0 CB                   (original data is 52)
-E 21B1 CB                   (original data is 52)
-E 2240 1E                   (original data is 06)
-E 2245 D8                   (original data is C0)
-E 2248 90                   (original data is 26)
-E 2252 1F CB                (original data is 07 9A)
-E 2D21 CB                   (original data is 2E)
-W
-Q
RENAME TGRAPHIC.EXX *.EXE
```

This fix also makes a PCjr only program - no longer for Tandy's. TANDY 1000 MOD IS STILL REQUIRED! This fixes the need for JRHOTKEY,

FIX 3: Enabling 3-voice sound in Tandy 16-color mode

The following enables PCjr/TANDY 3-voice sound by selecting the 3-voice sound source during F19 startup.

```
DEBUG F19.COM          (backup the original)
-E 103 E9 D0 05        (original data is bb 6e 00)
-E 6D6 BB 6E 00 1E B8 00 F0 8E D8 80 3E FE FF FD 75 06
-E 6E6 E4 61 0C 60 E6 61 1F E9 16 FA
-R CX                  (will display CX 05D6)
:05F0
-W
-Q
```

This adds sound selection of 3-voice chip to F19 startup, but F19 will use this sound mode only in 16-color mode (by loading TSOUND.EXE). This fix will only do something on a PCjr - it checks ROM ID first, so it will not affect use of F19 on any other PC type.

FIX 4: Swapping sounds type used in 16-color/4-color modes.

It is possible to swap the regular PC timer sound mode used with F19 CGA mode with the 3-voice sound used by F19 Tandy mode by swapping the ISOUND.EXE and TSOUND.EXE files:

1. 3-voice sound in CGA mode
 - a. RENAME ISOUND.EXE ISOUND.ORG (saves original file)
 - b. COPY TSOUND.EXE ISOUND.EXE (Tandy sound for CGA mode)
2. IBM PC timer sound in Tandy mode
 - a. RENAME TSOUND.EXE TSOUND.ORG (saves original file)
 - b. COPY ISOUND.EXE TSOUND.EXE(IBM PC sound for Tandy mode)

KINGS QUEST IV Patch

Patch to Run Kings Quest IV on a 640K PCjr:

1. Make a copy of disk #1
2. Work only with the copy.
3. in DOS, RENAME SIERRA.EXE SIERRA.EXX
4. in DOS, DEBUG SIERRA.EXX
5. in debug, perform the following dialogue.

```
-u 496(enter)
XXXX:0496 80FBFD      CMP  BL,FD
XXXX:0499 7508        JNZ  04A3
```

```

-
-
-
-a 499(enter)
XXXX:0499 JMP 04A3(enter)
XXXX:049B (enter)
-u 496
XXXX:0496 80FBFD          CMP BL,FD
XXXX:0499 EB08           JMP 04A3
-
-w(enter)
-q(enter)

```

6. in DOS, RENAME SIERRA.EXX SIERRA.EXE
7. Make a system disk with as little resident stuff as possible. No RAMDISKS, etc. RECOMMENDED JRCONFIG.SYS /V32.
8. Reboot with new system disk before trying Kings Quest IV.

PATCHING OTHER SIERRA SOFTWARE FOR THE PCjr

These patches work with Leisure Suit Larry and L.S.L. 2 as well as Police Quest 2.

The procedure for making the changes is:

- 1 - Use a binary editor or DEBUG to edit a copy of the SIERRA.EXE file as described earlier in the forum by Glenn Buskirk. Be careful because there are at least three different versions of this file out there now, depending on which version of which game you are playing. Make sure you patch your version correctly (keep a backup copy of the original).
- 2 - Use the statements below to create two short files, JR320.DBG and JR320.BAT.
- 3 - Put a copy of DEBUG.COM, JR320.DBG, JR320.BAT, and the TANDY320.DRV file from your Disk 1 all on a separate disk.
- 4 - Make the drive with these files your current drive. Type JR320 to execute the batch file of the same name. This will create a file called JR320.DRV on your disk.
- 5 - Copy JR320.DRV to your Disk 1 and run the INSTALL program that's also on that disk. Select the new option for "PCjr with - 16 colors" when prompted. When INSTALL's customization process is complete, you're all set. Start the game in the usual manner.

Use a low ramdisk (such as RAMDISK.COM provides) to take up space in the first 128K of memory to allow the games to play faster; make sure you have FILES=20 in your CONFIG.SYS or you'll have problems saving to the ramdisk; turn the character's speed all the way up; and be patient: the speed is not great, but it is definitely playable.

CREATING JR320.DBG

```
DEBUG (enter)          (press enter after each line)
-N JR320.DBG
E 10A 6A 72 33 32 30 20 20 20
E 113 50 43 6A 72 20
E 118 77 69 74 68 20 52 47 42
E 120 20 6D 6F 6E 69 74 6F 72
E 128 20 2D 20 31 36 20 63 6F
E 130 6C 6F 72 73 20 20 20 20
E 138 20 20
E 449 E8 24 03
E 770 B4 05 B0 80 CD 10 8A DF
E 778 32 FF B8 00 04 F7 E3 C3
R CX
0680
W
Q          (this creates the file and quits DEBUG)
```

CREATING JR320.BAT

```
COPY CON:JR320.BAT (enter)      (press enter after each line)
if not exist jr320.dbg goto noct1
copy tandy320.drv jr320.drv
debug jr320.drv (jr320.dbg
goto end
:noct1
Echo You must have JR320.DBG on this disk
echo for this process to work properly.
:end (Fn6)          (press Fn6 and press enter)
```

PRODIGY PATCH

This patch creates 16 Colors for the PCjr, it is in answer to the huge amount of Prodigy questions called in.

The change is simple. You MUST have 640K to implement this patch. It should work with any jr? You should also have a working knowledge of DOS Debug.

THE INSTRUCTIONS

1. Locate the module called 'TRS1000.SCR' and make a BACKUP copy.
2. Check the date on the module, Release 2 is dated 3/21/88. If the date is not the same the displacement following could well be different.
3. Load the module into debug. (DEBUG TRS1000.SCR)
4. Display the hex string at 'C28'. It should contain '00 B8 28 09' etc.
5. Change the byte at 'C29' to '18' (B8 to 18.
6. Save the module.
7. Copy the changed module (TRS1000.SCR. to 'DRIVER.SCR')
8. Make sure your memory driver is set for compatibility mode. ie; device=pjcrmem.com /c.
9. Remember to reboot the jr with the new driver.
10. Start PRODIGY If all goes well you should be in 16 color mode.

MISCELLANEOUS INFORMATION

1. JOYSTICK PORT PIN INFORMATION

Looking at the junior from the rear;

	J	J	L	K
A	1234	1234		
B	1234	1234		

A01 - Keyplug (no pin)
A02 - Logic GND
A03 - Y-Axis resistance
A04 - +5 Volt

B01 - Shield GND
B02 - X-Axis resistance
B03 - Switch
B04 - Switch

2. MAKING THE GENIUS MOUSE WORK WITH THE JUNIOR

The Genius Mouse model GM-6000 will work just as intended on your Junior.

The mouse driver, GMOUSE.COM does an initialization of the serial port directly into the divisor register and uses an incorrect value for the Junior. The code is MOV AX,6000 which results in a baud rate of 1160. Changing the instruction to MOV AX,5D00 provides a baud of about 1200 and resulted in the mouse working well.

Getting the GENIUS MOUSE and Dr. Halo to work requires using SWAPCOM2.COM to exchange serial ports and modifying GMOUSE.COM file by using debug in this manner;

DEBUG GMOUSE.COM (enter)

-e 232F (enter)
xxxx:232F 60. (you should see this line)
xxxx:232f 60.5D (add the 5D at this point and hit enter)
-w (enter) (this writes the modified file back to disk)
-q (enter) (quits debug)

The above procedure should get the GENIUS MOUSE and Dr. Halo working.

3. TECMAR JUNIOR CAPTAIN AT HIGHER SPEEDS

In answer to a lot of questions concerning speeding up the Tecmar memory sidecar. The NICKEL EXPRESS BOARD has three speeds 6.66, 7.37 and 8 MHZ and comes with these speedup instructions.

To fix the Tecmar boards you will need to unsolder or remove two capacitors on the Tecmar board. In the R/C network there is a metal plate and under it is two capacitors. You need to remove the large heatsink with its power transistor from the card. One capacitor is marked C-16 on the board and 101 on the component. Remove it and put it in a safe location. Next remove the one marked C-15 on the board and 331 component. Replace it with a 120 picofarad (pf) capacitor. This should allow it to run at the 7.37 MHZ speed level.

As an advanced project, one may want to try a 68 picofarad capacitor in the C-15 location and put in 100 ns (nanosecond) memory chips. THEORETICALLY, this should allow 8 MHZ operation??

4. VIDEO GATE ARRAY CHIP PROBLEMS

The symptom on stripped down Jr (i.e. power supply and mother bd only), was nothing but a change to a GREEN raster on the the color monitor. The unit exhibits no video, no audio and no beeps.

The Video Gate Array chip ZM-36 L1A0091 P/N 1503730 was finally identified as the problem. Subbing this part from the known good Junior confirmed this fact. I imagine that the problem could have been exhibited as any of the primary colors on the monitor.

LSI is the manufacturer and their part number is L1A0091. The series from which it was made LL5000 is now obsolete.

There are no plans to produce replacements at this time, and there is no stock of this item anywhere in IBM. If this part is identified as the failure point only an exchange system board can be utilized to solve the problem.

5. CHECKING FOR THE SPEECH ADAPTER

This is a basic routine that can be used as a stand alone program or as subroutine from within a program to check for the presence of the junior speech adapter ROM:

```

5 def seg=&HCE00
10 a$="6181736 COPR. IBM CORP 1984"
20 for I=7 to 28
30 b$=b$+(chr$(peek(I)))
40 next
50 if a$=b$ then goto 80
60 print"PCjr Speech adapter is not installed!"
70 goto 90
80 print"PCjr Speech adapter is installed"
90 def seg
100 return (or 100 end - if this is a program)

```

6. DUMPING A CARTRIDGE TO A DISK FILE

All you need to do is use DOS debug to dump cartridge data to a file. Bring up DEBUG and do the following at the debug prompt: (EXPERIMENTERS ONLY)

```

-n a:xxx.xxx (enter) (filespec for the file to be saved)
-m yyyy:0 zzzz 100 (enter) (yyyy=segment of cartridge data
                             zzzz=length of cartridge data to be
                             moved into location 100 -debug saves
                             from 100-)
-r cx (enter)
1111 (enter) (set up CX register with the length of
              cartridge should be equal to zzzz)
-w (enter) (write the data to the filespec)
-q (enter)

```

ADDITIONS TO THE COMPATABILITY ROSTER

Battle Tech 16 colors - 2
Calendar Creator Plus - ?
DS Backup - (for hard drives)
F19 - 2
Flight Simulator 4.0 - 6 (mono only)
Ford Simulator ver 2 - 6
Heros of the Lance - ?
Heros Quest 1 - 2
Hoyles Card Games - ?
Indiana Jones Last Crusade - 5
John Madden Football - ?
Kings Quest IV - 2,6
Leisure Suit Larry - 6
Leisure Suit Larry II - 2,6
Lotus 2.2 -6
My Label Maker - ?
Newsroom Pro - 6
Police Quest II - 2,6
Quick Bible Concordance - 6
Quite Write - ?
Rampage - 5
Red Storm Rising - 6
Sentinal Worlds I Future Magic - ?
Space Quest III - 6
Strike Fleet - ?
The Dual - Test Drive II - ?
Wizardry V (ver without disk protection)
Zany Golf - ?
688 Attack Sub - 6