

**ONE FOR THE MONEY, TWO FOR THE SLOW:**

# ADDING A SECOND DRIVE TO THE PCjr

by David G. Brader  
HCM Staff

---

*Much software designed for the IBM PC would run faster and more conveniently on the PCjr if the smaller machine had a second disk drive. Now you can add your own . . .*

---

*[Caveat: What follows is a hardware modification procedure for a PCjr with 128K of memory and the IBM single-disk system. The successful implementation of this procedure will result in a PCjr system capable of accessing two disk drives. This project assumes that you have the requisite technical skills and knowledge to complete it. We have done our best to include all the necessary data and procedural steps to guide a knowledgeable technician. Home Computer Magazine, its publisher, and the author assume no liability for unsuccessful project completion or damage to any of your equipment. Modification of the IBM PCjr will probably void any remaining warranty. These instructions are offered as is, and readers should proceed at their own risk—Ed.]*

## The Drive For Success

Tired of swapping diskettes in and out of your single-drive PCjr? What if you were told, "For less than \$300 (depending on how much you pay for the drive) and a few hours work you can have a second disk drive on Junior" Well, now you can.

When the PCjr was first announced as a single-drive system, we said, "Sure, bet all you have to do is stick an extension cable out the back of the box and daisy-chain a second drive to it." We were wrong. IBM very carefully de-engineered their disk-drive controller design making it impossible to simply change cables and add a second drive. Now here was a challenge!

Our answer to this challenge? Modification of the disk-drive controller board, requiring only the addition of two ICs (integrated circuits), the opening of two circuit paths on the board, the addition of ten wires to the board, and the construction of a new flat cable.

Initial tests of the hardware uncovered a roadblock—the IBM PCjr BIOS program (Basic Input/Output System stored in ROM memory) was the culprit. When Junior is reset or powered up, BIOS sets what are called

"equipment status software flags" in RAM memory which always report that only one disk drive (device name A:) is connected.

I therefore had to design a software fix to fool the system. With some special batch files installed on the PC-DOS 2.1 disk, I retested the system. DIR B: was entered at the keyboard, the red light on the second drive came on, and a moment later the directory listing of the data disk appeared on the PCjr screen—it worked!

## Three To Get Ready

Before attempting this modification, you need to accomplish three tasks: (1) Read this entire article and study the illustrations carefully, (2) purchase the parts needed for the modification, and (3) gather the necessary tools. Use the parts list in Figure 1 and the tool list in Figure 2 as checklists to make sure you have everything you need. When shopping for a second disk drive, make sure the drive is an IBM-compatible, double-sided, double-density model, either full-height or the newer half-height size, and that it comes with a case and power supply. Don't order a cable with the drive because a special one must be built for this application.

## Voiding The Warranty

It is important that you have good lighting for this work. Disconnect all cables from the rear of the PCjr including the power cord. Using a wide-blade screwdriver, pry up the top cover at the rear of the unit. Slide the cover back and remove it. Locate the disk-drive controller board with the wide flat cable connecting it to the disk drive. Disconnect the cable at the disk drive and carefully remove the controller board. Remove the flat cable from the controller board and lay it aside. Place the controller board, component side up, on a clean surface.

Referring to the board diagram in Figure 3, use a small, sharp pair of diagonal cutters to cut pin 1 of integrated circuit ZM21 free from the printed circuit board (snip it as close to the board as possible). Carefully bend the lead up and out from the board. We will be soldering a wire to it later.

**Figure 3.**

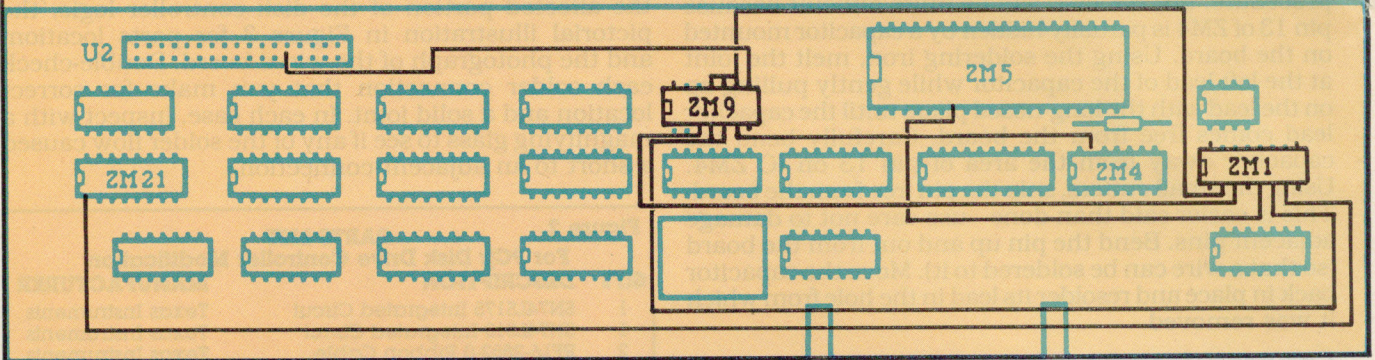

ABOVE: This diagram shows the layout of the major components on the IBM PCjr Disk-Drive Controller board. The two new ICs and new wiring are shown in black. Note the locations of ZM4 pin 13 and ZM21 pin 1; both need to be cut free from the circuit board prior to the addition of the new wires (see text).

**Figure 5.**

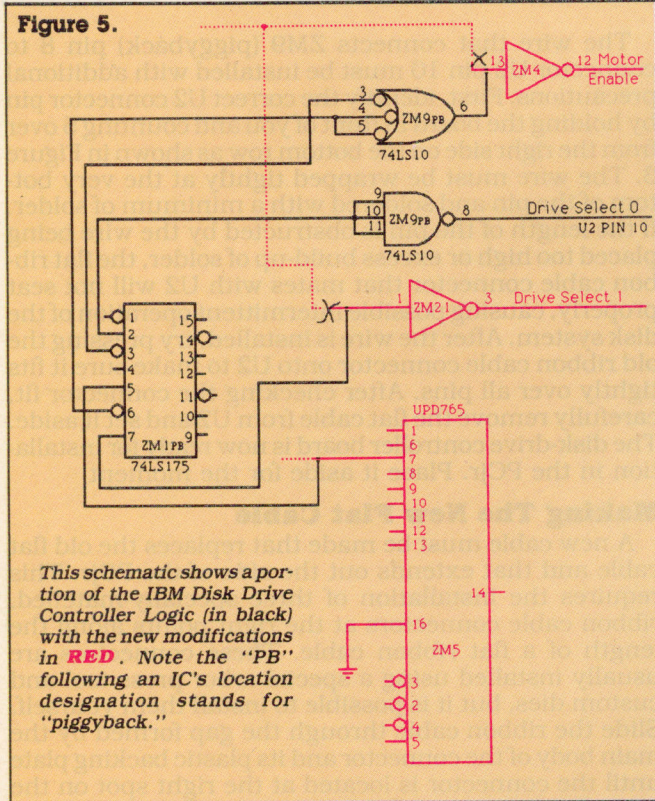

This schematic shows a portion of the IBM Disk Drive Controller Logic (in black) with the new modifications in RED. Note the "PB" following an IC's location designation stands for "piggyback."

BELOW: This photo shows the IBM PCjr Disk-Drive Controller board after the completion of modifications. Note the new wiring in white and the "piggy-back" ICs at locations ZM1 (74LS175) and ZM9 (74LS10).

RIGHT: The prepared "piggy-back" IC for location ZM9 (74LS10) is shown after its pins have been formed (or removed) per the instructions in the text.

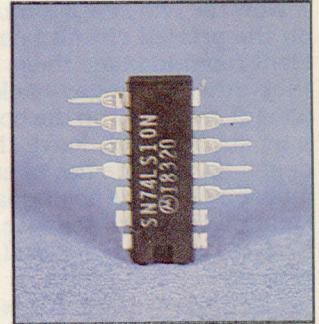

RIGHT: The prepared "piggy-back" IC for location ZM1 (74LS175) is shown here after its pins have been formed (or removed) per the instructions in the text.

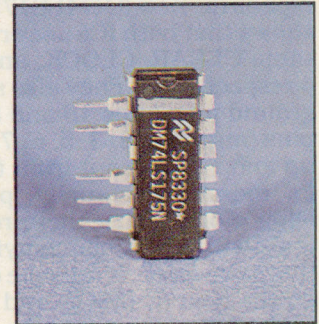

**Figure 4.**

**WIRE CONNECTION CHART FOR CONTROLLER BOARD FROM LOCATION TO LOCATION**

IC	PIN#	IC	PIN#
ZM1(piggyback)	2	ZM9(piggyback)	9
ZM9(piggyback)	9	ZM9(piggyback)	10
ZM9(piggyback)	10	ZM9(piggyback)	11
ZM1(piggyback)	3	ZM9(piggyback)	3
ZM1(piggyback)	5	ZM5	7
ZM1(piggyback)	6	ZM9(piggyback)	4
ZM9(piggyback)	4	ZM9(piggyback)	5
ZM1(piggyback)	7	ZM1	1
ZM9(piggyback)	6	ZM4	13
ZM9(piggyback)	8	U2(connector)	10

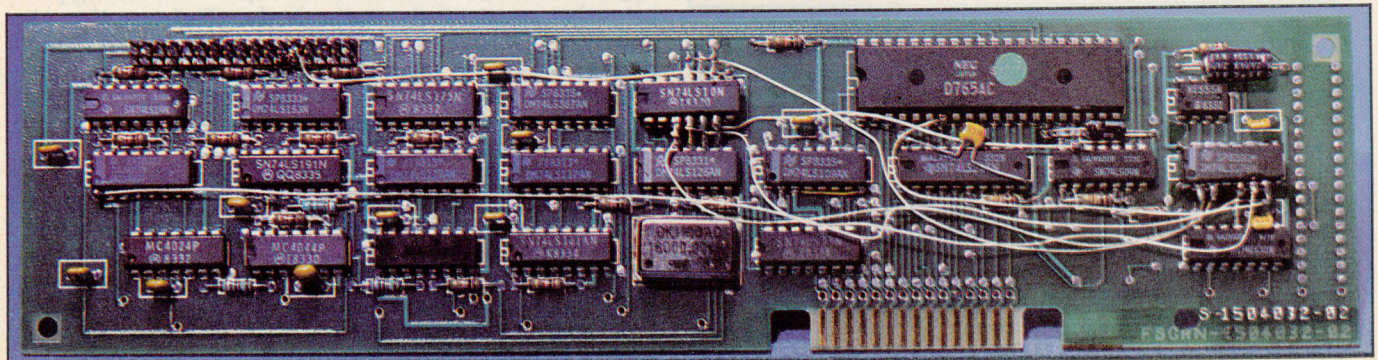

One other integrated circuit (IC) pin also requires this procedure, but the task will be more difficult because pin 13 of ZM4 is partially hidden by a capacitor mounted on the board. Using the soldering iron, melt the joint at the left lead of the capacitor while gently pulling up on the lead with the long-nosed pliers until the capacitor lead comes free from the board. Carefully bend the capacitor away from the area of pin 13 on IC ZM4. Using the small cutters, snip the pin free from the board. This is easier said than done—use care not to damage adjacent pins. Bend the pin up and out from the board (so that a wire can be soldered to it). Move the capacitor back in place and resolder its lead in the hole from which it was removed.

### **Congratulations, 10% Of The Job Is Done!**

Now the two new ICs must be prepared for mounting on the printed circuit board. Because there is insufficient room to place these ICs on the main board area, they must be "piggy-backed" onto other ICs that are already mounted on the board. Bend the "parasite" IC's pins straight out, leave them alone, or cut them off, depending on the use of each one (as described below and shown in the accompanying photos). The pins are counted counterclockwise as viewed from the top of the IC. Pin 1 is always located to the left of the dimple that is in one end of an IC.

The first one of our ICs is piggy-backed to the existing IC at location ZM1 (see Figure 3) which is of the same type as the new IC (74LS175). Investigation of the design shows that both ICs use or need to be connected to the same CLEAR, CLOCK, and D0 inputs (pins 9, 1, and 4 respectively). They also share the +5 volt power and ground pins (pins 16 and 8). By bending all the other pins (numbers 2, 3, 5, 6, 7, 10, 11, 12, 13, 14, and 15) up and straight out from the IC body, the IC is ready for mounting (actually, pins 10 through 15 can be clipped off because they are not used). The prepared IC is shown in the accompanying photo. To actually mount this parasite IC, it must be carefully aligned and seated on the host IC (ZM1), and all shared pins joined with solder (pin 1 to pin 1, pin 4 to pin 4, etc.). Be careful not to mount it backwards.

**Figure 1. TOOL LIST**  
**For PCjr Disk Drive Controller Modification**

DESCRIPTION	USE
Small long-nosed pliers	Bending leads on ICs
Very small diagonal-side cutters	Cutting IC leads
"No nick" wire strippers	Removing wire insulation
Low-wattage soldering iron	Soldering connections
Fine-wire rosin-core solder	Soldering connections
Spool of #28 tinned-copper wire with insulation	additional circuitry
Wooden-jaw vise	Making flat cable
Screwdriver set	Various uses

On the other parasite IC (74LS10) to be mounted there are only two shared pins. The +5 volt power and ground pins (pins 14 and 7) are the ones used to piggy-back this IC. All other pins are bent up and out from the IC body. The unused pins, 1, 2, 12, and 13, may be clipped off. The host IC for this parasite is in location ZM9, as shown in Figure 3 (the host IC is a type 74LS08). Carefully align and seat the new IC on the ZM9 host and solder pin 14 to pin 14 and pin 7 to pin 7.

### **Time To Get Wired, Folks!**

There are ten wires that must now be connected to the printed circuit board. Using a low-wattage soldering iron, attach the wires according to the chart in Figure

4. Refer to the partial schematic in Figure 5 showing the affected portion of the disk controller logic, the pictorial illustration in Figure 3 for parts location, and the photograph of the wired board. Double-check each solder connection that you make for correct location and a solid joint. In each case, inspect with a magnifying glass to see if any of the solder flow caused a short to an adjacent connection.

<b>Figure 2. PARTS LIST</b>		
<b>For PCjr Disk Drive Controller Modification</b>		
QTY	DESCRIPTION	MANUFACTURER
1	SN74LS175 Integrated Circuit	Texas Instruments
1	SN74LS10 Integrated Circuit	Texas Instruments
2	RF16-2852-0 Ribbon Cable Receptacle	Texas Instruments
1	SFM34-2841-0 Ribbon Cable Socket	Kel-Am Inc.
4	Feet of GEX28-34 Ribbon Cable	Kel-Am Inc.
1	IBM compatible dual-sided double-density Floppy disk drive with power supply and case. We used an MPI model 52 with a case and supply from a broken drive.)	MPI

The wire that connects ZM9 (piggyback) pin 8 to connector U2 pin 10 must be installed with additional precautions. First, identify the correct U2 connector pin by holding the board in front of you and counting 5 over from the right side on the bottom row as shown in Figure 3. The wire must be wrapped tightly at the very bottom of the pin and soldered with a minimum of solder. If the length of the pin is obstructed by the wire being placed too high or excess build-up of solder, the flat ribbon cable connector that mates with U2 will not seat properly, causing possible intermittent operation of the disk system. After the wire is installed, try pressing the old ribbon cable connector onto U2 to make sure it fits tightly over all pins. After checking the connector fit, carefully remove the flat cable from U2 and set it aside. The disk-drive controller board is now ready for installation in the PCjr. Place it aside for the moment.

### **Making The New Flat Cable**

A new cable must be made that replaces the old flat cable and that extends out the side of the PCjr. This requires the installation of three specially-matched, ribbon cable connectors at the right points along the length of a flat ribbon cable. These connectors are usually installed using a special arbor press tool and custom dies, but it is possible to install them yourself. Slide the ribbon cable through the gap formed by the main body of the connector and its plastic backing plate until the connector is located at the right spot on the cable. Using your hands, press the plastic backing plate into the main connector body as hard as you can to keep it from moving during the final step. Using a wood-working vise (don't use a vise with metal jaws), clamp the new connector assembly in such a fashion as to apply further pressure to seat the plastic backing plate into the connector's main body. Tighten the vise slowly while watching the gap between the flat cable and the connector body. Stop tightening when the cable and connector appear to have formed an airtight seal. *Warning: over-tightening the vise may damage the connector-cable assembly.*

Starting with one end of the ribbon cable, install the connector that will mate with the controller board match the distance between the connectors on the old IBM flat cable. Install this connector on the same side of the cable as the old IBM cable. The last connector, which will mate with the new external disk drive, is mounted on the other end of the cable (facing the same side as the other disk drive connector).

The completed project with the modified controller board and new cable installed prior to "buttoning up."

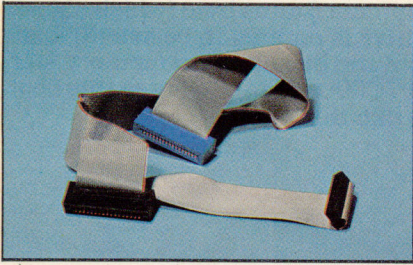

Shown above is the new cable that connects the modified controller board to the two disk drives (the original drive inside the PCjr and the additional drive on the outside). The portion between the controller board connector and the internal drive has been sized and formed to match the original IBM cable.

Notice how the old IBM cable was folded, and duplicate folds in the new cable. [*Home Computer Magazine* has a kit available for this project. It includes the two integrated circuits and the new finished flat cable. The cost of the kit is \$49.95.—Ed.]

### Cable Installation

Install the modified controller board in the PCjr, connect the new cable to the controller board, and connect the internal disk drive. Fold the free end of the cable so that it passes over the right side where the slot is molded into the case lip. Crease the cable so it will pass up and over any attachment when the PCjr lid is replaced.

### Disk Drive Address Selection

You've got one last item to take care of before replacing the PCjr lid—the internal disk-drive selector jumper. Notice that there are four sets of pins on the disk-drive circuit board next to the edge-type connector with the new flat cable. A plastic and metal jumper device is mounted on the second set of pins from the left. Pull this jumper off that set and press into the far left set of pins. This will ensure that the system recognizes this disk drive as "device name A:" which

The IBM internal disk drive's selection jumper is shown in its factory installed location on the left. It must be moved to the new location as shown on the right (see text).

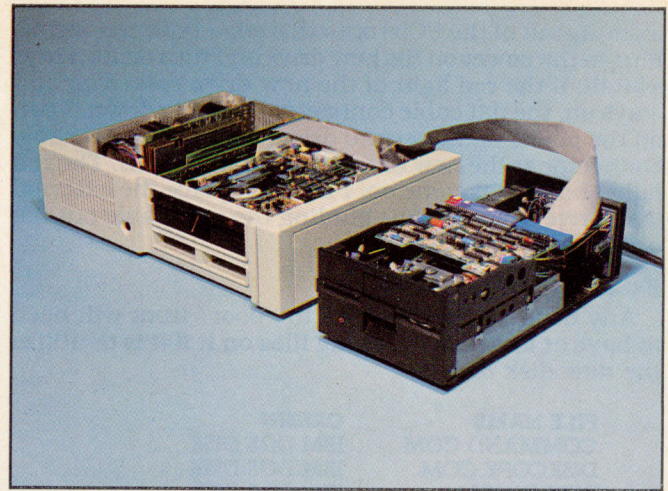
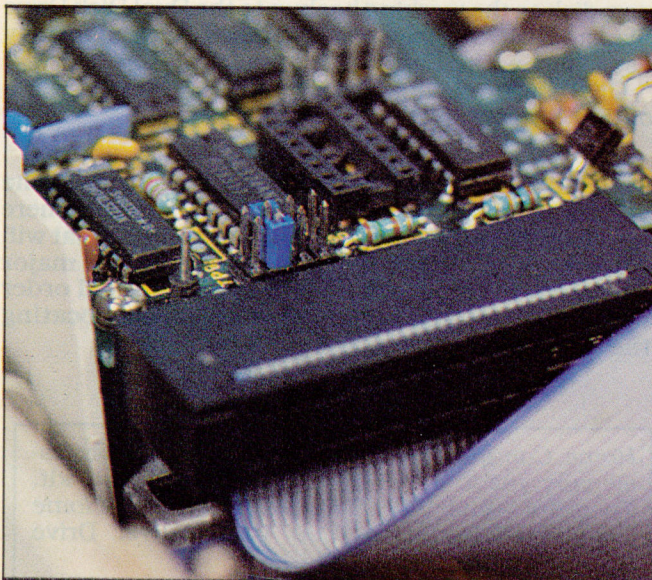

is the default drive at start-up time. Replace the PCjr lid, being careful to guide the cable out the slotted cover lip.

Place your new external disk drive to the right of the PCjr and remove its cover. The instructions that follow are general in nature because we have no way of knowing the precise configuration of the new drive that you purchased.

---

## "Initial tests of the hardware uncovered a roadblock—the IBM PCjr BIOS . . ."

---

The new disk drive must be set up as "device name B:" for the Disk Operating System. Locate the drive-select jumper area on the drive's circuit board. Usually, it will have letters printed on the circuit board next to it such as DS0, DS1, DS2, and DS3 (sometimes they are numbered 1, 2, 3, and 4). Make sure that all of these jumper options are "open" except the second from the lowest, which should be jumpered. This will select this drive as the second one ("B:"). Now locate the "load resistor" IC pack socket near the drive-select jumper area. If the socket is not empty, remove the resistor pack and discard it. Locate the edge-type connector of the new drive. Press the last connector of the new flat cable

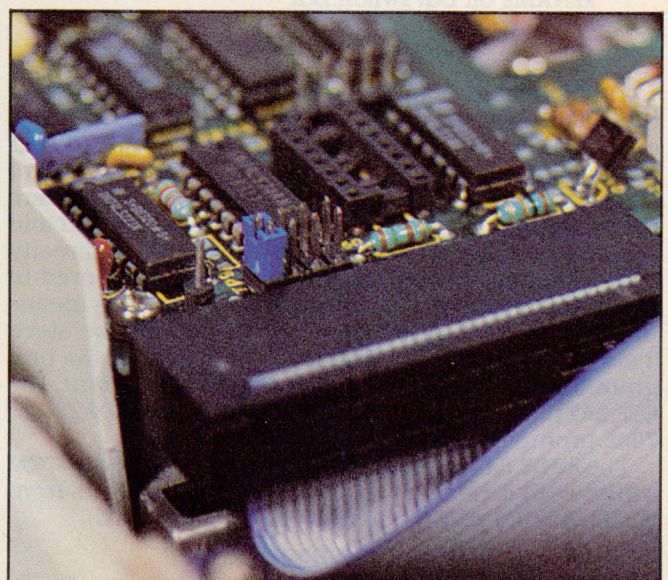

(coming out of the PCjr) onto this edge-type connector. Plug in the power on the new drive and turn on its power switch. If the red light of the new drive comes on and stays on, the flat cable connector is upside down. Turn off the power of the second drive, reverse the flat cable connector at the new drive end, and try again. The red light should not come on. Finally, replace the external disk drive's cover while guiding the new cable out the unit's cable slot.

## Fooling PCjr BIOS

Any diskette that you use to "boot" from will need to have at least the following files on it if it is to utilize the new disk drive:

FILE NAME	ORIGIN
COMMAND.COM	IBM DOS DISK
DISKCOPY.COM	IBM DOS DISK
DEBUG.COM	IBM DOS DISK
AUTOEXEC.BAT	SOURCE GIVEN BELOW
BOOT.BAT	SOURCE GIVEN BELOW
MODBOOT.BAT	SOURCE GIVEN BELOW
SWITCH.BAT	SOURCE GIVEN BELOW

Make certain that the diskette has been formatted with the /S option so that the IBM PC-DOS 2.10 and the COMMAND.COM file may be installed before installing the rest of the files. Then copy the DEBUG.COM and DISKCOPY.COM files from the master IBM PC-DOS 2.10 diskette onto the new boot disk. You can use a text processor, such as the IBM EDLIN that comes on the master PC-DOS 2.10 disk, to create the four BATch files described here.

---

### *“. . . BOOT will indirectly cause changes in the information that BIOS stored in RAM. . .”*

---

The AUTOEXEC.BAT file must contain the following lines exactly as they appear here, in the order that they appear:

```
IF EXIST switch.bat GOTO first
GOTO last
.first
RENAME switch.bat off.bat
BOOT
.last
RENAME off.bat switch.bat
DATE
TIME
```

AUTOEXEC.BAT is automatically executed each time the PCjr system is powered up or reset. As it executes, it first checks to see if the file SWITCH.BAT exists on the disk in drive A:. If it does (and it should) the program logic will GOTO the line labeled .last. Here the program renames the SWITCH.BAT file to OFF.BAT and executes the file called BOOT.BAT. BOOT will indirectly cause changes in the information that BIOS stored in RAM and will affect a restart of the system. This means that AUTOEXEC.BAT is executed again from the start. This time the SWITCH.BAT file doesn't exist, so the program logic will GOTO the label .last. At this point, the OFF.BAT file is renamed to SWITCH.BAT, and the DATE and TIME prompts appear.

The BOOT.BAT file simply starts up the IBM DEBUG.COM utility with directions to take debug commands from the MODBOOT.BAT file instead of the keyboard:

```
DEBUG < MODBOOT.BAT
```

The MODBOOT.BAT file causes four things to happen: It (1) assembles a short assembly language routine starting at location hexadecimal 9080 in memory; (2) executes this same routine causing the bit in the system's Equipment Status byte (which signals that a second disk drive is on line) to be set; (3) loads the "boot track" from the diskette into memory starting at Hexadecimal 7C00; and (4) executes this boot. MODBOOT.BAT looks like this:

```
AO 0:980
XOR AX,AX
MOV DS,AX
OR BY (410),40
NOP
[insert a blank line here to stop assembly.--Author]
G=0:9080 9089
L 0:7C00 0 0 1
G=0:7C00
```

The last file to be created allows AUTOEXEC to detect where it is in its sequence. The SWITCH.BAT file is only a dummy which must exist on the disk, but may contain anything at all. We simply entered a comment line describing its function as follows:

```
REM This is a dummy file used in booting.
```

Once these four files are on your new boot disk, label that disk as the PCjr Dual Disk Drive System Disk.

## Now, Go Man Go!

This is it. Make sure the new Dual Disk Drive System Disk is in the A: drive (the one in the PCjr case). Place any other good IBM formatted diskette in the new external drive. Turn on the power to all system units (the PCjr itself should always be last), and watch the screen. After about 45 seconds of clicks, flashes, and text scrolling on the screen, you should see the prompt for the date. Enter the date and the time.

The big test is to now try accessing the second drive. Enter DIR B: and press the [ ENTER ] key. You should see the second disk-drive light come on, and the directory of the diskette in that drive should appear on the screen. If it doesn't, recheck each of the new files that you placed on the boot disk for errors. Also, have your modification work checked by someone else for errors. Once you are successful, place a blank diskette into the new drive (B:), enter DISKCOPY A: B: and press [ ENTER ]. Press any key to start the process. Watch how fast the system now copies a disk! Isn't that worth all this work? Label the new disk as the working backup to the Dual Disk Drive System Disk and copy any other files that you usually use (such as the EasyWriter II system files).

OK, that's it. Have fun exploring the wonderful world of IBM PC software!

**Note:** Listed above are the manufacturers of the specific products that were used in our project. There are other manufacturers of similar products that will work as well. Sources for these items are major electronics component distributors and mail order houses. Sorry, you are on your own when locating the disk drive.

Home Computer Magazine can supply a professionally made cable and the two ICs in a kit. To order, send \$49.95 to PCjr Disk Kit, Home Computer Magazine, 1500 Valley River Drive Suite 250, Eugene, OR 97401.