

Matrox RT.X100 Xtreme

Installation and User Guide

May 1, 2003



10804-201-0200

Trademarks • Marques déposées • Warenzeichen • Marchi registrati • Marcas registradas

Matrox Electronic Systems Ltd.	Matrox [®] , DigiSuite [®] , Flex 3D [™] , MediaExport [™] , MediaTools [™] , RT2500 [™] , RT.X100 Xtreme [™] , SinglePass [™] , X.tools [™] , XtremePreview [™]
Matrox Graphics Inc	G550 [™] , P650 [™] , P750 [™] , Millennium [™] , Parhelia [™]
Adobe Systems Inc	Adobe [®] , Acrobat [®] , After Effects [®] , Photoshop [®] , Premiere [®]
Advanced Micro Devices, Inc	AMD Athlon [™]
Apple Computer, Inc	Apple [®] , FireWire [™]
Autodesk, Inc	3ds max [™]
Canon Inc	Canon [®]
Creative Technology Ltd.	Audigy [™] , SoundBlaster [™]
Inscriber Technology Corporation	Inscriber [®] , TitleExpress [™]
Intel Corporation	Intel [®] , Pentium [®]
International Business Machines Corporation	IBM [®] , VGA [®]
JVC	D-9 [™] , Digital-S [™]
Ligos Incorporated	Ligos [®] , GoMotion [®]
Microsoft Corporation	Microsoft [®] , ActiveMovie [®] , DirectShow [®] , DirectSound [®] , DirectX [®] , Internet Explorer [®] , Windows [®] , Windows NetMeeting [®] , Video for Windows [™] , Windows Media [™] , Windows Media Player [™]
NewTek, Inc	LightWave 3D [™]
Panasonic (Matsushita Electric Industrial Co.)	Panasonic [®] , DVCPRO [™] , DVCPRO50 [™]
Pixélan Software	Pixélan Software [™] , Video SpiceRack Lite [™]
Rambus Inc	RDRAM [®]
RealNetworks, Inc	RealNetworks [®] , RealPlayer [®] , RealVideo [®] , RealMedia [™] , Helix [™]
Sonic Desktop Software	SmartSound [®] , Quicktracks [™]
Sonic Foundry	Vegas Video [®]
Sonic Solutions	Sonic [™] , Sonic Solutions [™] , DVDit! [®] , ReelDVD Studio [®] , cDVD [™] , CinePlayer [™]
Sony Electronics Inc	Sony [®] , DVCam [™]

Matrox MediaExport utilizes portions of Microsoft Windows Media Technologies.
Copyright © 1999-2003 Microsoft Corporation. All rights reserved.

Matrox MediaExport utilizes portions of RealNetworks RealProducer and Helix Producer Technologies.

RealNetworks technology is provided under license from RealNetworks, Inc., © 1995-2003 RealNetworks, Inc. and/or its suppliers. P.O. Box 91123, Seattle, Washington 98111-9223, U.S.A. Patents Pending. All rights reserved.

Matrox MediaExport utilizes portions of Ligos GoMotion Technologies.

Copyright © 2003 Ligos Incorporated. All rights reserved.

Acrobat[®] Reader Copyright © 1987-2003 Adobe Systems Incorporated. All rights reserved. Adobe and Acrobat are trademarks of Adobe Systems Incorporated, which may be registered in certain jurisdictions.

• (English) All other nationally and internationally recognized trademarks and tradenames are hereby acknowledged. • (Français) Toutes les autres marques et tous les autres noms déposés reconnus nationalement ou internationalement sont également reconnus par les présentes. • (Deutsch) Alle sonstigen national und international bekannten Warenzeichen und Produktnamen werden hiermit anerkannt. • (Italiano) Eventuali altri nomi di prodotto menzionati in questo manuale sono dei proprietà di rispettivi produttori. • (Español) Por medio del presente se reconocen todas las demás marcas y nombres comerciales reconocidos a nivel nacional e internacional.

Copyright © 2003 Matrox Electronic Systems Ltd. • (English) All rights reserved. • (Français) Tous droits réservés. • (Deutsch) Alle Rechte vorbehalten. • (Italiano) Tutti i diritti riservati. • (Español) Reservados todos los derechos.

Disclaimer Matrox Electronic Systems Ltd. reserves the right to make changes in specifications at any time and without notice. The information provided by this document is believed to be accurate and reliable. However, no responsibility is assumed by Matrox Electronic Systems Ltd. for its use; nor for any infringements of patents or other rights of third parties resulting from its use. No license is granted under any patents or patent rights of Matrox Electronic Systems Ltd. Unauthorized recording or use of broadcast television programming, video tape, or other copyrighted material may violate copyright laws. Matrox Electronic Systems Ltd. assumes no responsibility for the illegal duplication, use, or other acts that infringe on the rights of copyright owners.

Matrox Electronic Systems Ltd.

1055 St. Regis Blvd., Dorval, Quebec, Canada H9P 2T4

Tel: (514) 685-2630 Fax: (514) 685-2853 World Wide Web: www.matrox.com

Thank you for choosing Matrox

Warranty

A. Limited Warranty Statement

- 1 Matrox Electronic Systems Ltd. ("Matrox") warrants to the end-user customer who provides adequate proof of purchase, that Matrox hardware products purchased from Matrox authorized dealers will be free from defects in materials and workmanship for a period of three (3) years from the date of purchase. This warranty applies only to the original end-user purchaser and is non-transferable. Conditions and limitations of Matrox's warranty are stated below.
- 2 Matrox's limited warranty covers only those defects that arise as a result of normal use of the hardware and does not apply to any:
 - a improper or inadequate maintenance;
 - b incompatibilities due to the user's hardware or software applications with or in which the Matrox product interfaces;
 - c product of a special or custom-made nature;
 - d unauthorized modification or misuse;
 - e improper installation, misapplication or negligence;
 - f operation outside the product's environmental specifications;
 - g improper site preparation or maintenance;
 - h software;
 - i other causes that do not relate to a product defect;
 - j defects or damage suffered as a result of force majeure (including theft);
 - k defects or damage suffered as a result of normal wear and tear; and/or
 - l stolen goods.
- 3 If Matrox receives, during the applicable warranty period, notice of a defect in a warranted hardware product and the defective Matrox product in question, Matrox shall at its sole option, either repair or replace the product, and shall return the repaired product or a replacement product within a reasonable delay. The replacement product may not be new, provided that it has functionality at least equal to that of the product being replaced.
- 4 This warranty is valid in any country where Matrox hardware products are distributed by Matrox or its authorized dealers.
- 5 This Limited Warranty Statement gives the customer specific legal rights. The customer may also have other rights which vary from state to state in the United States, from province to province in Canada, and from country to country elsewhere in the world.

B. Limitations of Warranty

- 1 NEITHER MATROX NOR ANY OF ITS THIRD PARTY SUPPLIERS MAKES ANY OTHER WARRANTY OF ANY KIND, WHETHER EXPRESSED OR IMPLIED, WITH RESPECT TO MATROX PRODUCTS. MATROX SPECIFICALLY DISCLAIMS (and the customer, by accepting the Matrox product, specifically accepts such disclaimer and waives) ALL OTHER WARRANTIES, EITHER EXPRESSED OR IMPLIED, INCLUDING BUT NOT LIMITED TO THE IMPLIED WARRANTIES OF MERCHANTABILITY AND FITNESS FOR A PARTICULAR OR INTENDED PURPOSE OR USE AND THE WARRANTY AGAINST LATENT DEFECTS, WITH RESPECT TO THE HARDWARE AND/OR SOFTWARE. MATROX FURTHER DISCLAIMS ANY WARRANTY THAT MATROX PRODUCTS, IN WHOLE OR IN PART, WILL BE FREE FROM INFRINGEMENT OF ANY THIRD PARTY INTELLECTUAL PROPERTY OR PROPRIETARY RIGHTS."
- 2 To the extent that this Limited Warranty Statement is inconsistent with the law of the locality where the customer purchases the Matrox product, this Limited Warranty Statement shall be deemed modified to be consistent with such local law. Under such local law, certain limitations of this Limited Warranty Statement may not apply to the consumer.
- 3 To the extent allowed by local law, the remedies provided in this Limited Warranty Statement are the customer's sole and exclusive remedies.

C. Limitations of Liability

- 1 EXCEPT FOR THE OBLIGATIONS SPECIFICALLY SET FORTH IN THE LIMITED WARRANTY STATEMENT, IN NO EVENT SHALL MATROX BE LIABLE FOR:
 - a any direct, indirect, special, incidental, consequential, foreseeable or unforeseeable, or punitive damages, whether based on contract, tort, delict or any other legal theory and whether advised of the possibility of such damages; and/or
 - b damages arising from the loss of use, data, production revenue and/or profit of in connection with the Matrox product or any business interruption.
- 2 Without prejudice to the foregoing, any liability of Matrox for any breach of warranty shall be limited to the amount paid by the customer for the defective hardware in question.
- 3 To the extent allowed by local law, Matrox's entire liability and the customer's exclusive remedy shall be the repair or replacement of any defective product during the warranty period. Matrox does not offer any other warranty with respect to Matrox hardware or software or any other hardware or software.
- 4 Customer shall be responsible for all applicable taxes, duties and customs fees on any replacement unit, as well as all transport, insurance, storage and other charges incurred on all returned products.

D. Obtaining Service in North America

- 1 Verify that your Matrox product was installed and configured according to the information in its accompanying documentation.
- 2 Read the "Troubleshooting" information included with the Matrox product to see if you can solve the problem yourself.
- 3 If you are still experiencing difficulties, please contact your dealer where you purchased your Matrox product.
- 4 If you must return a Matrox product, leave the configuration as it was when you were using it, and leave all identification stickers on the product. Pack the product in its original box and return to your Matrox dealer where the product was purchased, together with your proof of purchase. Your Matrox dealer will return the product for you. Alternatively, if this first option is unavailable to you, you may contact the Matrox Technical Support group who will issue a Return Merchandise Authorization (RMA) number, upon receipt of adequate proof of purchase, and inform you of shipping instructions. **DO NOT RETURN THE PRODUCT TO MATROX WITHOUT MATROX'S RMA NUMBER AND EXPRESS AUTHORIZATION.**

E. Obtaining Service outside North America

- 1 Verify that your Matrox product was installed and configured according to the information in its accompanying documentation.
- 2 Read the "Troubleshooting" information included with the Matrox product to see if you can solve the problem yourself.
- 3 If you are still experiencing difficulties, please contact your dealer where you purchased your Matrox product.
- 4 If you must return a Matrox product, leave the configuration as it was when you were using it, and leave all identification stickers on the product. Pack the product in its original box and return to your Matrox dealer where the product was purchased, together with your proof of purchase. Your Matrox dealer will return the product for you.

F. General

This limited warranty shall be governed by the laws of the Province of Quebec, Canada and the federal laws of Canada applicable therein and the courts of the Province of Quebec shall have exclusive jurisdiction to hear and decide any dispute instituted by the customer in connection with this limited warranty; the customer waives, by accepting the product, its rights to institute proceedings in connection with this warranty against Matrox in any jurisdiction other than Quebec.

Software license agreement

Single User Products. This Matrox software (the “Software”) is copyrighted by Matrox Electronic Systems Ltd. All rights are reserved. The purchaser is granted a license to use the software only, subject to the following restrictions and limitations.

- 1 The license is for the original purchaser only, and is not transferable without written permission of Matrox.
- 2 The original purchaser may use the Software on a single computer owned or leased by the original purchaser. You may not use the Software on more than a single machine, even if you own or lease more than one machine, without written consent of Matrox.
- 3 The original purchaser may make back-up copies of the Software for his or her own use only, subject to the use limitations of this license.
- 4 The original purchaser may not engage in, nor permit third parties to engage in, any of the following:
 - Providing or disclosing the Software to third parties.
 - Providing use of the Software in a computer service business, network, time-sharing, multiple CPU or multi-user arrangement to users who are not individually licensed by Matrox.
 - Making alterations or copies of any kind in the Software (except as specifically permitted above).
 - Attempting to unassemble, de-compile or reverse engineer the Software in any way.
 - Granting sublicenses, leases, or other rights in the Software to others.
 - Making copies, or verbal or media translations, of the user’s guide.
 - Making telecommunication data transmissions of the Software.

Matrox reserves the right to terminate this license if there is a violation of its term or default by the Original Purchaser. Upon termination, for any reason, all copies of the Software must be immediately returned to Matrox, and the Original Purchaser shall be liable to Matrox for any and all damages suffered as a result of the violation or default.

Limited warranty. Matrox warrants to you, for a period of ninety (90) days normal use from your date of purchase, that:

- 1 The CD/disks on which the software is furnished and the documentation are not defective.
- 2 The Software is properly recorded upon the CD/disks included.
- 3 The documentation is substantially complete and contains all the information Matrox deems necessary to use the software.
- 4 The Software functions substantially as described in the documentation.

Matrox’s entire liability and your exclusive remedy shall be the replacement of any CD/Disks or documentation not meeting these warranties, which is returned to Matrox or an authorized dealer, together with a copy of your paid receipt. The above is the only warranty of any kind, either express or implied, including, but not limited to the implied warranties of merchantability and fitness for a particular use that is made by Matrox on this Licensed Software. In no event shall Matrox be liable to you or to any third party for consequential, special, indirect or incidental damages which you may incur as a result of using the licensed software, including, but not limited to, loss of data, or information of any kind which you may experience.

This limited warranty shall be governed by the laws of the Province of Quebec, Canada and the federal laws of Canada applicable therein and the courts of the Province of Quebec shall have exclusive jurisdiction to hear and decide any dispute instituted by the customer in connection with this limited warranty; the customer waives, by accepting the product, its rights to institute proceedings in connection with this warranty against Matrox in any jurisdiction other than Quebec.

Contents

Chapter 1

Introducing Matrox RT.X100 Xtreme

Welcome	2
Matrox RT.X100 Xtreme features.....	2
Hardware supplied.....	3
Software supplied	3
System requirements.....	4
DualHead and TripleHead editing using Matrox display cards	5
Check our web site for equipment information.....	5
Style conventions of this manual	5
A note about screen shots in this manual.....	5
Other documentation.....	5
Installation overview	6
Keep a record of your serial numbers.....	6

Chapter 2

Preparing Your System

Overview of the preparation steps	8
1. Plan your storage configuration and install your drives	8
Matrox RT.X100 Xtreme data transfer rate requirements	8
General storage considerations.....	8
Dedicated Audio/Video (A/V) and export drives	9
2. Install Windows XP or Windows 2000	11
3. Configure your Windows display	12
If you're using a Matrox P650, P750, or Parhelia card	12
4. Configure your sound card	13
Set your volume levels.....	13
5. Install Adobe Premiere.....	14
6. Install your third-party software.....	14
Are you ready?.....	15

Chapter 3

Installing Your RT.X100 Xtreme and Connecting Your Devices

Before you begin	18
Installation overview	18
1. Install your Matrox RT.X100 Xtreme card	18
2. Connect your RT.X100 Xtreme breakout cable and computer speakers.....	20
Connections to a sound card with an external breakout box	22
3. Typical RT.X100 Xtreme connections	23
DV-1394 connections	23
S-Video connections using same device for capture and print-to-tape	24
Composite connections using separate source and record devices...	25
4. Connect your DV-1394 device.....	26
Hot-plugging	26
5. Connect your composite and S-Video devices	27
Composite input/output connections	28
S-Video input/output connections	30
Are you ready?	32

Chapter 4

Installing Your Matrox RT.X100 Xtreme Software

Before you begin	34
Overview of the software installation	34
1. Hardware detection	34
2. Install Matrox X.tools	35
3. Register your RT.X100 Xtreme	36
4. Install additional software from the RT.X menu.....	36
Adding the Matrox plug-in to LightWave 3D	37
Installing the Matrox VFW software codecs on a system without the RT.X100 Xtreme hardware	37
5. Install Sonic Solutions DVDIt! SE.....	38
6. Install Sonic ReelDVD Studio	38
Removing your Matrox RT.X100 Xtreme software	38

Are you ready?.....	39
Chapter 5	
Defining Your Adobe Premiere Settings	
A note about running other programs with Adobe Premiere	42
Loading project presets.....	42
Setting up your scratch disks	42
Setting your low disk space warning level.....	42
Defining your General settings.....	43
Selecting your NTSC setup level for analog video	44
Selecting your editing aspect ratio.....	46
Switching between scrubbing types	46
Selecting your speed control method.....	47
Selecting your codec options for rendering.....	48
Selecting your DV-1394 settings	50
Selecting your realtime effect settings.....	52
Defining your Video settings	54
Defining your Audio settings	54
Defining your Capture settings	55
Using the Matrox scopes to analyze your analog video	59
Running the Audio Capture Drift Detection test	62
Performing a Premiere export to disk	64
Performing a Matrox realtime export to disk.....	65
Selecting your MPEG-2 IBP settings.....	67
Setting up DV-1394 device control	69
Exporting your Timeline to DV tape	71
Preparing your tapes for recording.....	71
Obtaining a frame-accurate export to tape	71
Exporting to DV tape with device control.....	71
Defining your export to tape options	74
Things you need to know about using DV-1394 devices	76
Creating a production in 16:9 format	77

Chapter 6

Setting Up Realtime Effects with Adobe Premiere

Available effects	80
How to place your effects to avoid rendering.....	81
How to apply a Matrox transition in Adobe Premiere	83
How to apply a Matrox video effect in Adobe Premiere	83
Applying Matrox video effects to graphics.....	83
Using common controls in the plug-in.....	84
Specifying a default Matrox effect	86
Common controls on the Custom pages.....	87
Previewing your effects	88
Using text boxes and sliders	89
Undoing and redoing changes	89
Selecting colors	90
Applying a pre-created 3D tile	91
Creating a custom 3D tile.....	92
Applying a pre-created advanced DVE	94
Creating a custom advanced DVE	96
Applying a pre-created basic DVE	98
Creating a custom basic DVE.....	99
Applying a pre-created blur effect	100
Creating a custom blur effect.....	101
Overview of the chroma key effect	102
Creating a chroma key effect.....	103
Viewing and selecting your key colors.....	105
Applying a pre-created color correction	107
Creating a custom color correction	108
Using the Matrox scopes	110
Applying a pre-created colorization effect.....	116
Creating a custom colorization effect	117
Applying a pre-created cube effect	119
Creating a custom cube effect.....	121
Customizing your cube effect using the Preview Window	123

Overview of the luma key effect	124
Creating a luma key effect.....	125
Viewing and selecting your luminance values	127
Applying a pre-created mask DVE effect	129
Creating a custom mask DVE effect.....	131
Adding your own mask patterns.....	132
Applying a pre-created organic wipe	134
Creating a custom organic wipe.....	135
Adding your own organic wipe patterns	136
Applying a pre-created page curl.....	138
Creating a custom page curl	139
Applying a pre-created particle effect.....	141
Creating a custom particle effect	143
Customizing your particle effect using the Preview Window.....	144
Applying a pre-created sphere effect.....	146
Creating a custom sphere effect.....	147
Customizing your sphere effect using the Preview Window	148
Transforming your clip	149
Using the transform controls	150
Using the Transform menu	151
Transforming a clip using the Preview Window.....	152
Cropping your effect	153
Using the Cropping Window	154
Using the crop controls	155
Using the Crop menu.....	155
Cropping an effect using the Preview Window	156
Working with keyframes	157
Using the keyframes controls	157
Creating new keyframes.....	159
Modifying keyframes	159
Resetting a track to default settings	159
Selecting keyframes	160
Copying and moving keyframes	160
Pasting attributes of a keyframe (“selective paste”)	161

Deleting keyframes.....	162
Saving and loading keyframe files.....	162
Interpolating between keyframes	163
Keyboard shortcuts.....	166
Setting up realtime graphics overlays	167
What is XtremePreview?	169
Adaptive degradation	169
Automatic solo mode preview	169
A/B mode preview.....	170
RT.X100 Xtreme realtime rules	170
Supported graphics formats	170
General rule.....	171
Combining effects	171
Order of effects	171
Restrictions.....	172
Monitoring your CPU usage.....	173

Chapter 7

Using RT.X100 Xtreme with Video for Windows Programs

Overview.....	176
Using VFW programs without the RT.X100 Xtreme hardware	177
Before you start rendering	177
Selecting color space conversion options	178
Rendering material to a Matrox VFW .avi file	179
Before you start capturing	180
Capturing material for your production	180
Selecting your capture source and adjusting proc amp settings	180
Selecting your capture format and resolution	182
A note about capturing video with audio	183

Chapter 8

Using Matrox MediaTools

About Matrox MediaTools	186
Preparing your tapes for use with MediaTools	186
Starting Matrox MediaTools	187

Using the Matrox MediaTools interface	188
Using the MediaTools pop-up menu.....	190
Navigating through clips with the transport controls.....	190
Using the time code fields	191
Defining your capture settings	194
Selecting your capture folder.....	195
How MediaTools assigns clip names.....	196
Scanning and capturing clips	196
Capturing individual clips from tape	197
Capturing live video	197
Creating a batch capture list	198
Scanning clips.....	198
Adding clips to a batch capture list.....	199
Capturing clips from a batch capture list	200
Editing clips	200
Updating and recapturing clips.....	200
Changing a clip's In and Out icons.....	201
Working with the clip list	201
Adding clips	201
Saving and loading a clip list	202
Copying clips	202
Moving clips.....	202
Deleting clips	203
Detaching and resizing the clip list.....	203
Grabbing a single-frame image	204
Exporting your clip list to an Adobe Premiere project	205
Keyboard shortcuts	206
 Chapter 9	
Using Matrox MediaExport	
About Matrox MediaExport.....	210
Starting the Matrox MediaExport plug-in.....	210
Overview of the Matrox MediaExport dialog box	211
Using the MediaExport pop-up menu	212

- Exporting clips from the Timeline212**
- Selecting encoding profiles and adding clip information.....213**
 - Selecting encoding profiles for use in the session window 213
 - Adding clip information to your streaming video..... 215
- Modifying standard profile settings to create a customized profile.....215**
- Fine-tuning your customized encoding profiles216**
 - Selecting your RealMedia codec options.....217
 - Selecting your Windows Media codec options 219
 - Customizing your target audience settings220
 - Selecting your Ligos MPEG common settings222
 - Customizing your Ligos MPEG GOP structure and motion vector settings.....223
 - Customizing your Ligos MPEG bit rate settings.....225
 - Ligos-compliant profile settings.....226
- Adding your customized profile to the profile library..... 228**
- Saving and loading your encoding session 229**

- Chapter 10**
- Using the Adobe After Effects plug-in**
 - About the Adobe After Effects plug-in..... 232**
 - Required settings to use the plug-in 232**

- Chapter 11**
- Using the 3ds max plug-in**
 - About the 3ds max plug-in 236**
 - Required settings to use the plug-in 236**

- Chapter 12**
- Using the LightWave 3D plug-in**
 - About the LightWave 3D plug-in..... 238**
 - Required settings to use the plug-in 238**

- Chapter 13**
- Using Sonic DVDit! SE**
 - Overview..... 240**

Exporting material for your DVD project	241
Creating a DVD volume	243
Playing your DVD volume using a software DVD player	245
Chapter 14	
Using the WYSIWYG DirectShow Control Panel	
Overview	248
Configuring the WYSIWYG DirectShow Control Panel	249
Chapter 15	
RT.X100 Xtreme Troubleshooting	
Problems, possible causes, and solutions.....	252
Up-to-date information	252
Possible solutions	252
Multiple solutions	252
Installation/configuration	253
Using Adobe Premiere	255
Capture issues	261
Export issues	262
Audio issues	263
DVD/CD authoring	264
Appendix A	
Data Rates and A/V Disk Space Requirements	
DV/MPEG-2 qualities and required disk space	266
Audio sampling and required disk space	266
Recommended MPEG data rates for distribution on DVD-R or CD-R	267
Appendix B	
RT.X100 Xtreme Specifications	
Matrox RT.X100 Xtreme card specifications.....	270
General.....	270
Video	270
Audio	270
Environmental specifications	270

Appendix C

Matrox RT.X100 Xtreme Glossary

Glossary of terms 272

Appendix D

RT.X100 Xtreme Customer Support

Getting the most support 284

 Register your RT.X100 Xtreme 284

 Keep up to date with our web site 284

Contacting us 285

Appendix E

Matrox Around the World

 Worldwide Headquarters..... 288

 Europe, Middle East, Africa 288

 France 288

 Germany..... 288

 Asia Pacific 288

Index 289

1

Introducing Matrox RT.X100 Xtreme

This chapter outlines some of the features of your RT.X100 Xtreme, lists the contents of your kit, and describes the available RT.X100 Xtreme documentation.

Welcome

Matrox RT.X100 Xtreme gives you access to many unique professional features that are not available on any other video editing card in its class. Its unique architecture incorporates “The Power of X,” which leverages the scalable power of your CPU with the explosive performance of dedicated hardware for the ultimate realtime video editing experience.

Matrox RT.X100 Xtreme features

- Adobe Premiere like you’ve never seen it before—better capture tools, full-quality turbo-charged editing, and faster export.
- Realtime DV-1394, composite, and S-Video input and output.
- Realtime SinglePass DV scan and capture.
- Realtime MPEG-2 capture and export for DVD authoring.
- Realtime advanced color correction and RGB gain/offset colorization.
- Professional vectorscope and waveform monitors.
- Realtime chroma and luma keying.
- Realtime adjustable speed control with blended-field processing for super-smooth slow or fast motion.
- Realtime Matrox Flex 3D effects, such as 3D DVEs, blurs, page curls, and many more.
- Freedom to combine and keyframe many effects in real time, at full quality.
- XtremePreview for editing many layers and effects without rendering.
- Hardware-accelerated simultaneous batch encoding of DVD, VCD, SVCD, multimedia, and web formats.
- Video capture using Video for Windows programs.
- Output to NTSC or PAL video monitor when using supported animation, compositing, and DirectShow applications (including Windows Media Player).
- Professional DVD authoring with Sonic ReelDVD Studio and creation of simple DVD projects with Sonic DVDit! SE.

Hardware supplied

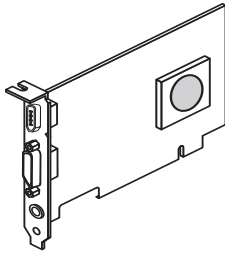

RT.X100 Xtreme card

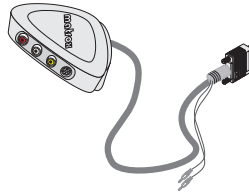

Breakout cable



**4-to-6 pin
1394 cable**



Note The color of cables or other components in your Matrox RT.X100 Xtreme kit may vary from the illustration on your Matrox RT.X100 Xtreme box.

Software supplied

- **Matrox X.tools** Includes the necessary drivers for Matrox RT.X100 Xtreme, and the following software:
 - **Matrox realtime plug-in for Adobe Premiere** Lets you add realtime effects and transitions to your Adobe Premiere projects.
 - **Matrox MediaTools** A DV capture application that lets you perform automatic, unattended DV tape scanning and batch capture in a single pass.
 - **Matrox MediaExport** Lets you export material from your Adobe Premiere projects to Windows Media, RealMedia, and MPEG formats.
 - **WYSIWYG DirectShow Control Panel** Lets you display video played back using Windows Media Player and other supported DirectShow applications on your NTSC or PAL video monitor. This gives you a WYSIWYG (What You See Is What You Get) video display for checking how your clips appear on a TV or other interlaced monitor. If you connect an analog video recorder to your RT.X100 Xtreme system, you can record your clips onto tape as they play back on your video monitor.
- **Matrox WYSIWYG plug-ins** Let you display your animations and compositions on your NTSC or PAL video monitor. You'll see the exact color temperature, safe-title area, and any interlaced artifacts as you work. Plug-ins are available for Adobe After Effects, Discreet 3ds max, and NewTek LightWave 3D.
- **Adobe Premiere** A nonlinear video editing program. Adobe Premiere is bundled with additional software that you can choose to install, such as SmartSound Quicktracks (for soundtrack creation) and demo programs.
- **Sonic ReelDVD Studio** A professional DVD authoring program.

- **Sonic DVDit! SE** A DVD authoring program for creating simple DVD projects.

System requirements

Matrox RT.X100 Xtreme requires the following minimum system configuration:

- Microsoft Windows XP Home or Professional, or Windows 2000 Professional with Service Pack 2 or later.
- Intel Pentium III at 1 GHz, Pentium 4 at 1.8 GHz, or AMD Athlon XP 1500+.
- 512 MB physical memory (RAM).
- Free PCI slot.
- Display card (Matrox Millennium G550, P650, P750, or Parhelia recommended).
- 16-bit sound card (DirectSound-compatible).
- CD-ROM drive for software installation.
- At least 500 MB of free space for software installation on system drive (considerably more if installing all files to be able to switch video standards).
- Separate hard drive for A/V content.
- Video camera or VCR.



Note Realtime DV output requires the recommended system configuration listed below. Certain complex effects, or combinations of effects, require a more powerful system to prevent dropped frames during playback. Because some of the Matrox realtime effects are CPU-based, upgrading to a more powerful CPU might allow you to combine more of these effects.

Recommended system configuration:

- Pentium 4 at 2.2 GHz, AMD Athlon XP 2000+, or faster.¹
- 512 MB DDR RAM or RDRAM.
- Service Pack 1 for Windows XP, or Service Pack 3 for Windows 2000.
- DV-1394 camcorder or VTR.
- NTSC or PAL video monitor.
- Additional A/V drive for realtime export to disk.

¹ It is recommended that you use a computer equipped with a power supply of at least 300 watts. Although RT.X100 Xtreme does not consume much power, fully configured recommended systems with a high-end graphics card (such as Matrox Parhelia), two or three hard drives, and a powerful CPU, will push the limits of a 250-watt power supply.

DualHead and TripleHead editing using Matrox display cards

Many video editors prefer the larger desktop workspace that two or three monitors can provide. We recommend the Matrox G550, P650, P750, and Matrox Parhelia display cards, which are optimized for DualHead and/or TripleHead editing with Matrox RT.X100 Xtreme.

Check our web site for equipment information

For up-to-date information about recommended computer systems, motherboards, and other RT.X100 Xtreme-compatible devices such as display cards, sound cards, and DV-1394 devices, see the RT.X Support section of our web site at www.matrox.com/vidoweb/support.

Style conventions of this manual

The following style conventions are used in this manual:

- The names of files, directory paths, and manuals appear in *italics*. For example:
 - The data is stored in the *sample.wav* file.
 - The file is located in your *C:\Windows\System* directory.
 - Please refer to your *Adobe Premiere User Guide*.
- Menus and commands that you need to choose are displayed in the form **Menu > Command**. For example, **File > Save** means click **File** in the menu bar, then click **Save** in the menu that appears.
- The names of keys are displayed in small capital bold letters, such as the **CTRL** key.
- A plus (+) sign is used to indicate combinations of keys and/or mouse operations. For example:
 - **CTRL+C** means to hold down the **CTRL** key while pressing the **C** key.
 - **SHIFT+click** means to hold down the **SHIFT** key while you click an item with the mouse.

A note about screen shots in this manual

Sample screen shots of dialog boxes in this manual were taken on an NTSC system with Windows XP installed. If you have a different system configuration (such as a PAL system), your settings may not match those of the screen shots.

Other documentation

In addition to this manual, you have access to other documents.

Last-minute information

Any important information that wasn't available for inclusion in the manual by publication time is provided to you in one or both of the following:

- The *Readme* file installed with the software in the Matrox X.tools folder.
- Printed Release Notes packaged with the manual.

Other electronic documents

The following electronic documents are also available:

- HTML-based online Help installed on your hard drive.



Note To properly view online Help, you must have Microsoft Internet Explorer 4.0 or later (5.0 or later is recommended).

- A PDF version of this manual is available from the RT.X Support section of our web site (see below).

Web site

We update the RT.X Support section of our web site on a regular basis. You can always find the most up-to-date information about your RT.X100 Xtreme there. See www.matrox.com/videoweb/support.

Installation overview

The following steps summarize the installation procedure for your Matrox RT.X100 Xtreme system.



Important Please read the detailed instructions in each chapter before attempting the installation.

- 1 Prepare your system for the RT.X100 Xtreme installation. See [Chapter 2, “Preparing Your System.”](#)
- 2 Install your RT.X100 Xtreme hardware and connect your external devices. See [Chapter 3, “Installing Your RT.X100 Xtreme and Connecting Your Devices.”](#)
- 3 Install Matrox X.tools, register your RT.X100 Xtreme, and install the rest of the software. See [Chapter 4, “Installing Your Matrox RT.X100 Xtreme Software.”](#)

Keep a record of your serial numbers

Take care not to discard the serial numbers provided with your bundled software. You usually need these numbers when you install the software, and also when requesting software upgrades. It's a good idea to write down all your serial numbers and keep them in a safe place so that you can easily refer to them when needed.

2

Preparing Your System

This chapter provides you with essential steps to prepare your computer system for a successful RT.X100 Xtreme installation.

Overview of the preparation steps

In order to ensure a successful RT.X100 Xtreme installation and trouble-free operation afterwards, there are certain things you **must** do to prepare your system before installing your RT.X100 Xtreme hardware and software.

The following list provides an **overview** of the steps required. These steps are explained in greater detail later in this chapter.

- 1 Plan your storage configuration and install your drives. See page 8.
- 2 Install Windows XP or Windows 2000 on your system drive. See page 11.
- 3 Configure your Windows display. See page 12.
- 4 Configure your sound card. See page 13.
- 5 Install Adobe Premiere. See page 14.
- 6 Install your third-party software. See page 14.



Important You **must** follow all the steps in this chapter before attempting to install your Matrox RT.X100 Xtreme card and software.

1. Plan your storage configuration and install your drives

You should plan how you'll set up your storage devices and then connect them accordingly. If you're installing your RT.X100 Xtreme card in an existing system, you may have to reconfigure your storage connections for proper performance. If you have a new system, it's important to set up your system right the first time. For all cases, the instructions in this section will help you avoid problems or having to repeat procedures later on.

Matrox RT.X100 Xtreme data transfer rate requirements

To be compatible with the dual-stream operation of Matrox RT.X100 Xtreme, the storage device you use must sustain a data rate of at least 12 MB/sec.



Note Our tests have shown that 1394 hard drives are not capable of sustaining the data transfer rates that are needed for video editing with RT.X100 Xtreme.

General storage considerations

Storage plays a vital role in the overall performance of your Matrox RT.X100 Xtreme system. Without adequate storage for your audio and video clips, your system will not work properly.

Certain issues, such as what to store on your A/V drives, use of the NTFS file system, and disk fragmentation, are important to the use of both EIDE and SCSI storage devices with Matrox RT.X100 Xtreme.

Dedicated Audio/Video (A/V) and export drives

To use Matrox RT.X100 Xtreme, you must store your audio, video, and graphics files on an A/V drive reserved solely for this purpose. If you want to perform realtime exports to disk, you'll also need an additional drive dedicated to perform exports. Windows frequently needs to access your system drive for various reasons, so attempting to store your audio/video files on your system drive will provide unacceptable performance.

Your system's virtual memory paging (swap) file must be stored on your system drive and **not** on your A/V drive. By default, Windows stores this file on your system drive. For information on how to configure your system's virtual memory, see your Windows documentation.



Note Do not create multiple partitions on your A/V drives. Doing so can reduce performance leading to dropped frames in your projects. Make sure you have only one partition per A/V drive.

Planning your connections

In addition to most SCSI devices, almost all recent EIDE storage devices are able to meet the data throughput requirements of your Matrox RT.X100 Xtreme system. You can have only two EIDE devices on each of the two controller connections found in most PCs. When you connect your EIDE devices, you **must** connect your A/V drive and your dedicated export drive to separate controllers.

The following diagram provides a typical EIDE device configuration for your system:

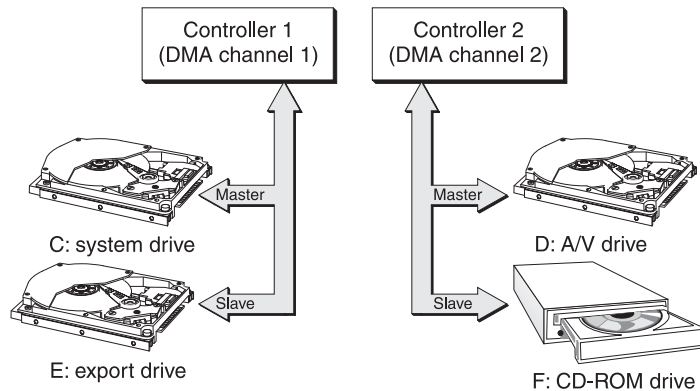

Optimal system with separate system, A/V, and export drives

1. Plan your storage configuration and install your drives

The following diagram provides an example of an **improper** EIDE device configuration.

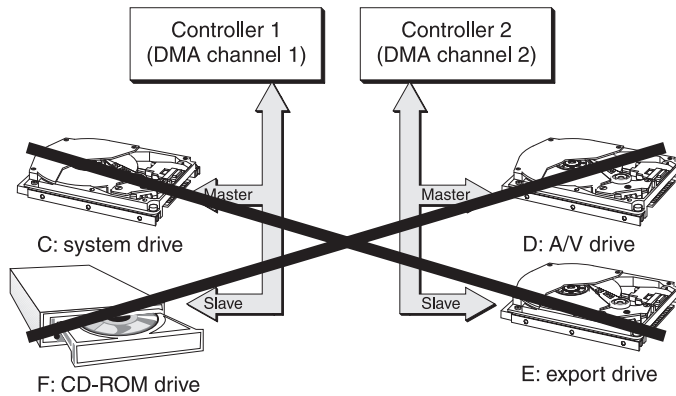

Storage information on our web site

Most hard drives and controller cards manufactured in the past year should be suitable for use in your Matrox RT.X100 Xtreme system. For more information on storage recommendations, and a list of any devices we've found to be unsuitable for use with RT.X100 Xtreme, see the RT.X Support section of our web site at www.matrox.com/video/web/support.

Using ATA RAID controllers

If you are using an ATA RAID controller to create a striped volume consisting of two or more drives, the volume can be used for both the A/V and export drives. Please refer to your RAID controller's documentation for information on how to create and configure striped volumes.



Important If you are using an ATA/133 RAID controller, make sure that you stripe your EIDE drives using Windows Disk Management. Failure to do so may result in erratic behavior of your RT.X100 Xtreme system.

Use the NTFS file system

Your A/V drives **must** be formatted using NTFS for use with Matrox RT.X100 Xtreme because NTFS overcomes FAT32 file size limitations. When a hard drive is formatted using FAT32, files saved to this drive cannot exceed 4 gigabytes in size. This translates to approximately 20 minutes of DV video, which poses a serious limitation to a nonlinear editing platform like your Matrox RT.X100 Xtreme system.

With NTFS, you also have the option of creating a striped volume, which consists of multiple hard drives formatted as a single partition. This allows you to work with multiple drives as a single large drive, which offers more disk space and enhances hard drive performance. NTFS also provides better audio and video synchronization than FAT32 when you play back your clips.

If you already have Windows installed on your computer, you can check the format of your drives. In Windows Explorer, right-click the drive letter (such as D:), then choose **Properties**. Under **General**, check the format of your drive next to **File system**.

If you need to format a drive using NTFS, right-click **My Computer**, then choose **Manage**. Under **Computer Management > Storage**, select **Disk Management**. In the **Disk Management** utility, right-click the appropriate drive and choose **Format**. In the provided dialog box, specify a volume label for the partition you are creating. From the **File System** list, select **NTFS**. Leave the **Allocation unit size** at **Default**. Do not select the **Enable file and folder compression** option. If you are formatting the drive for the first time, do not select the **Perform a quick format** option either.

 **Important** All information on the designated drive will be lost.

For more information on how to format your storage devices using NTFS, see your Windows documentation.

Disk defragmentation

It's important to make sure that your storage does not become too fragmented. Overly fragmented drives will lead to a major reduction in your system's performance, which will in turn seriously reduce the RT.X100 Xtreme's ability to work properly.

 **Important** To ensure that your storage is operating at optimal levels, defragment your hard drives regularly (once a month at least).

For information on how to defragment your storage devices, see your Windows documentation.

2. Install Windows XP or Windows 2000

 **Important** Make sure your RT.X100 Xtreme card is **not** installed in your computer when you install your Windows software. If it is, Windows will attempt to install software drivers for it. This could cause software conflicts when you install your RT.X100 Xtreme software.

Install Windows XP (Home or Professional with Service Pack 1 or later) or Windows 2000 Professional (with Service Pack 3 or later). If your Windows CD does not contain the appropriate service pack, you can obtain the software from the Microsoft web site at www.microsoft.com. If you already have Windows installed, you can check which service pack is installed by right-clicking **My Computer**, then choosing **Properties > General**.



Note To carry out the installation and configuration procedures that follow, you must log onto an account on your Windows system that has Administrator privileges. For details, consult the appropriate Microsoft documentation.

3. Configure your Windows display

Before you install your RT.X hardware and software, you should configure your Windows display as follows.



If you have Windows XP:

- 1 Right-click your Windows desktop background, then choose **Properties**.
- 2 Under the **Settings** tab, select a **Screen resolution** of at least **1024 by 768 pixels** (or 2048 by 768 pixels for a dual-monitor setup), and a **Color quality** of **Medium (16 bit)** or **Highest (32 bit)**. We recommend 16-bit color for better performance.
- 3 Under the **Appearance** tab, select **Normal** for **Font Size**.
- 4 Under **Themes**, make sure that you select one of the Windows standard themes (that is, the themes that are included with your Windows system).



If you have Windows 2000:

- 1 Right-click your Windows desktop background, then choose **Properties**.
- 2 Under the **Settings** tab, select a **Screen area** of at least **1024 by 768 pixels** (or **2048 by 768 pixels** for a dual-monitor setup), and set your **Colors** to **High Color (16 bit)** or **True Color (32 bit)**. We recommend 16-bit color for better performance.
- 3 Click the **Advanced** button, then select **Small Fonts** for **Font Size**. Click **OK**.
- 4 Under the **Appearance** tab, make sure that you select one of the Windows standard schemes (that is, the schemes that are included with your Windows system).



Note If you are using a Matrox dual-head display card, to be able to preview video (such as in Premiere's **Monitor** window) on your second monitor, you must set the resolution and color display settings on your secondary monitor to the same as your primary monitor.

If you're using a Matrox P650, P750, or Parhelia card

When using a Matrox P650, P750, or Parhelia display card with your RT.X100 Xtreme system, configure your display with a maximum of 16.8 million colors. To verify your display settings, right-click your **Matrox PowerDesk HF** icon on your desktop and choose **Quality and Performance Settings**. In the **Quality and Performance Settings** dialog box, choose **Desktop Settings**. Under **Maximum number of simultaneous colors**, make sure that **16.8 million** is selected.



Note When working in Adobe Premiere, do **not** connect your video monitor to the output of your Matrox display card.

4. Configure your sound card

To use your Matrox RT.X100 Xtreme, you must have a DirectSound-compatible 16-bit sound card installed and properly configured with the latest drivers. For information on installing your sound card, see the documentation that came with your card.

If your system has on-board audio, and you want to install a separate sound card, you'll have to disable the on-board audio in your system's BIOS. For details on how to do this, see your computer's documentation.

For information on supported sound cards, see the RT.X Support section of our web site at www.matrox.com/videweb/support.

Set your volume levels

To properly capture and play back audio, make sure you've set appropriate recording and playback volume levels as follows:

- 1 Double-click the speaker icon on the Windows taskbar.



- Tip** If you don't see the speaker icon on your Windows taskbar:
- In Windows XP, run **Sounds and Audio Devices** from the Windows Control Panel, select **Place volume icon in the taskbar**, then click **OK**.
 - In Windows 2000, run **Sounds and Multimedia** from the Windows Control Panel, select **Show volume control on the taskbar**, then click **OK**.

- 2 Choose **Options > Properties**.

- 3 Select the **Recording** option, then select all check boxes in the list. Click **OK**.

- 4 For each of the controls (**Line-in**, **Microphone**, etc.), make sure the **Volume** sliders are at an appropriate level, such as at half-level. As well, clear all the **Mute** check boxes.



Note Some items in Volume Control may contain a **Select** check box instead of a **Mute** check box. Enable **Select** to turn on sound for those items.

- 5 Choose **Options > Properties**.

- 6 Select the **Playback** option, then select all check boxes in the list. Click **OK**.

- 7 For each of the controls (**Line-in**, **Wave**, etc.), make sure the **Volume** sliders are at an appropriate level, such as at half-level. As well, clear all the **Mute** check boxes.

- 8 Close the dialog box.

5. Install Adobe Premiere

You **must** install Adobe Premiere before installing your RT.X100 Xtreme card. If you don't do so, you won't be able to install Matrox X.tools.



To install Adobe Premiere:

- 1 Close all Windows programs.
- 2 Insert the Adobe Premiere installation CD into your CD-ROM drive.
- 3 From the CD menu, choose to install Adobe Premiere. When the setup program starts, follow the onscreen instructions. If Windows doesn't automatically start the setup program, you can start it manually as follows:
 - a Choose **Start > Run**.
 - b In the resulting dialog box, type `e:\premiere\setup` (where *e:* represents your CD-ROM drive), and click **OK**.
- 4 You can choose to install any other programs or tryouts from the Adobe Premiere CD menu.



Note When you install the RT.X100 Xtreme software (that is, Matrox X.tools), RT.X100 Xtreme files will be added to your Adobe Premiere's *Plug-ins* folder on your hard drive. Therefore, if you later re-install Adobe Premiere to a different directory, you'll need to also re-install Matrox X.tools.

6. Install your third-party software

There are a number of programs for which you can install a Matrox WYSIWYG (What You See Is What You Get) plug-in that lets you see your work directly on your NTSC or PAL video monitor:

- **Adobe After Effects** For 2D or 3D motion graphics and visual effects.
- **3ds max** For 3D modeling, animation, and rendering of visual effects.
- **LightWave 3D** For 3D graphics and animation.

If you have any of these programs, you'll need to install them now so that you'll be able to install the Matrox plug-in for them later (see [Chapter 4, "Installing Your Matrox RT.X100 Xtreme Software,"](#) on page 33).



Note When you install the Matrox plug-in for one of these programs, RT.X100 Xtreme files will be added to folders on your hard drive for that program. Therefore, if you later re-install the program to a different directory, you'll need to also re-install the Matrox plug-in.

Are you ready?

Before continuing, go back over the steps in this chapter and make sure you've carried out all necessary preparations.

Have you...

- Installed and connected your storage devices?
- Installed Windows XP or Windows 2000 on your system drive?
- Configured your Windows display?
- Installed and configured your sound card?
- Installed Adobe Premiere?
- Installed any third-party programs for which you want to install a Matrox plug-in?

If you've prepared your system for RT.X100 Xtreme installation, shut down Windows and turn your computer's power off before proceeding to the next chapter.

Your notes

3

Installing Your RT.X100 Xtreme and Connecting Your Devices

This chapter describes how to install your Matrox RT.X100 Xtreme card in your computer and how to connect your external devices to your computer.

Before you begin

Before proceeding with this chapter, make sure you've prepared your system for the Matrox RT.X100 Xtreme installation as explained in the previous chapter.

Installation overview

The following list provides an **overview** of the steps to install your RT.X100 Xtreme card and connect your breakout cable and devices. These steps are explained in detail in this chapter.

- 1 Install your Matrox RT.X100 Xtreme card. See the next section.
- 2 Connect your RT.X100 Xtreme breakout cable and computer speakers. See page 20.
- 3 If you want to quickly set up a typical editing system, refer to the typical RT.X100 Xtreme connections. See page 23.
- 4 Connect your DV-1394 device. See page 26.
- 5 Connect your composite and S-Video devices. See page 27.

1. Install your Matrox RT.X100 Xtreme card

For information specific to your computer, such as how to remove its cover, see your computer manual.



Caution Static electricity can severely damage electronic parts. Before touching any electronic parts, drain the static electricity from your body. You can do this by touching the metal frame of your computer. Hold your RT.X100 Xtreme card by its edges and avoid touching its circuitry.

- 1 Turn off your computer.
- 2 Unplug your computer, then remove its cover.
- 3 Choose the appropriate expansion slot for your Matrox RT.X100 Xtreme card. Certain motherboards require that you install your RT.X100 Xtreme card in a specific slot. For information on which slot to use for your specific motherboard, see the RT.X Support section of our web site at www.matrox.com/videoweb/support.
 - a Most computers have different types of expansion slots. Choose a **PCI** slot for your RT.X100 Xtreme card. Your computer manual should identify the location of each type of expansion slot in your computer.



Caution Inserting your Matrox RT.X100 Xtreme card into the wrong type of slot could damage your card, your computer, or both.

- b Remove the brackets from the slot you intend to use. Save the screw for the mounting bracket.

- 4 Insert your RT.X100 Xtreme card.
 - a Position your RT.X100 Xtreme card over the PCI slot you've chosen.
 - b Push the card in firmly and evenly until it's fully seated in its slot.

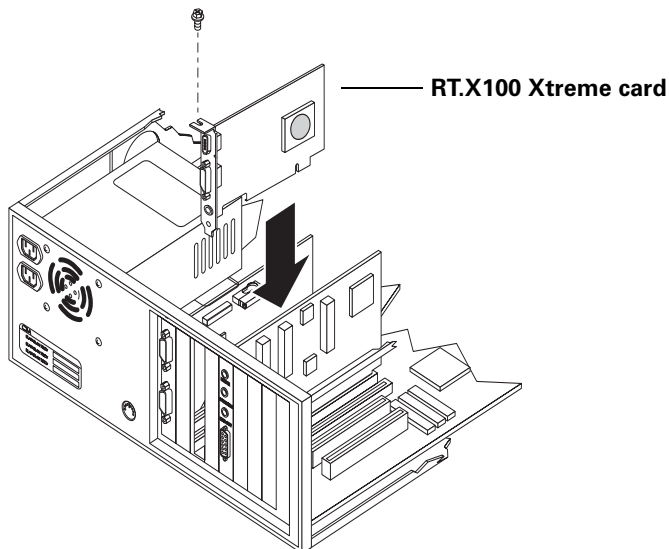

- c Using the fastening screw, secure your RT.X100 Xtreme card's bracket to the computer frame.
 - d Replace your computer's cover.



Important Don't turn on your computer yet. Proceed to the next section to connect your RT.X100 Xtreme breakout cable and computer speakers.

2. Connect your RT.X100 Xtreme breakout cable and computer speakers

To connect your RT.X100 Xtreme breakout cable and your computer speakers:

- 1 Plug the connector into the RT.X100 Xtreme socket labeled **VIDEO**.
- 2 Plug the light blue and light green audio connectors (labeled **TO AUDIO CARD IN** and **TO AUDIO CARD OUT**) into the corresponding colored jacks on your sound card. If your sound card doesn't have colored jacks, refer to the labels on the connectors.



Note If your computer speakers are connected to your sound card, unplug them from your sound card, then proceed to the next step.

- 3 To connect your computer speakers, simply plug the connector into the RT.X100 Xtreme socket labeled **AUDIO**.

If your sound card has an external breakout box (or “rack”), see the next section for details on how to connect your RT.X100 Xtreme breakout cable to your audio breakout box.

The following illustration shows the **TO AUDIO CARD IN** cable connected to the **LINE IN** of the sound card. However, you can also connect the cable to another input of your sound card, for example, **AUX IN**. Regardless of the input to which you've connected the **TO AUDIO CARD IN** cable, you must specify your analog audio input as described in the section “[Defining your Capture settings](#)” on page 55 in order to capture analog audio.

You can choose to connect your other external devices either before or after installing your RT.X100 Xtreme software. For details on how to install your software, see [Chapter 4, “Installing Your Matrox RT.X100 Xtreme Software,”](#) on page 33.

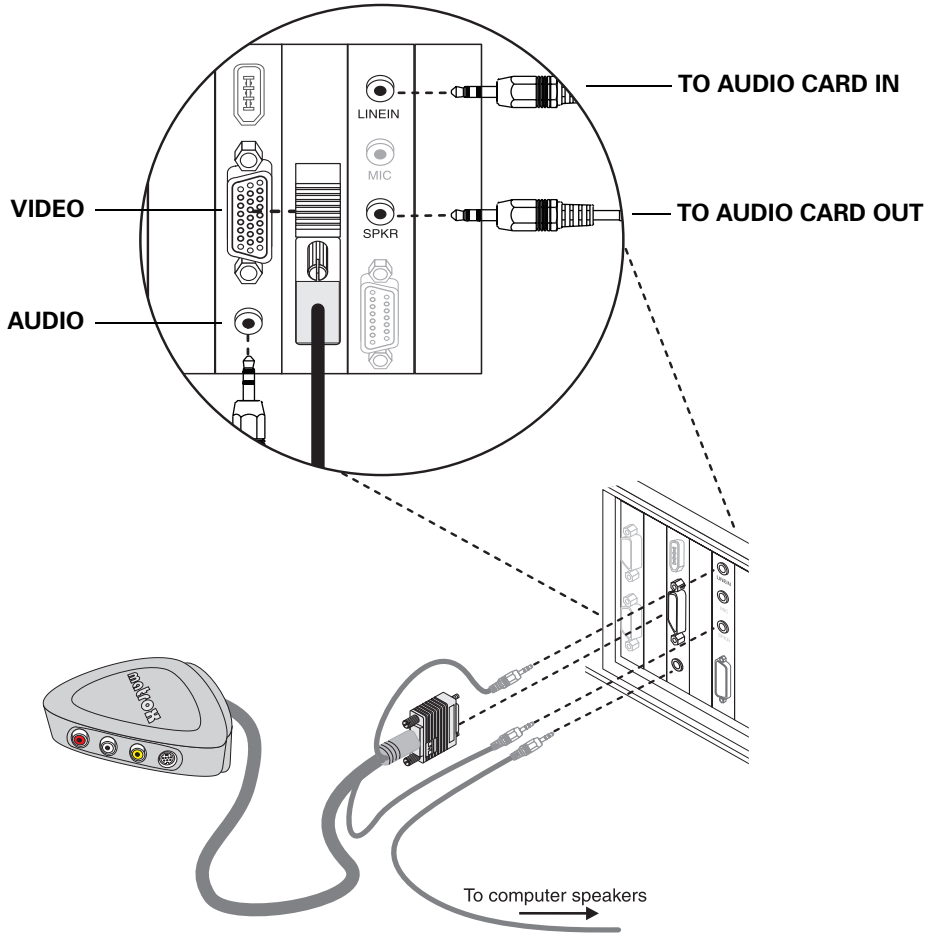

2. Connect your RT.X100 Xtreme breakout cable and computer speakers

Connections to a sound card with an external breakout box

Some sound cards have an external audio breakout box (sometimes referred to as a “rack”) to simplify connecting other devices. If you have an external audio breakout box, you connect the audio input and output on your RT.X100 Xtreme breakout cable differently than explained in the previous section.

⇒ To connect to an external audio breakout box:

- 1 Connect the light blue connector labeled **TO AUDIO CARD IN** on your RT.X100 Xtreme breakout cable to the **LINE IN** jack (or corresponding jack) on the front panel of your audio breakout box.
- 2 Connect the light green connector labeled **TO AUDIO CARD OUT** on your RT.X100 Xtreme breakout cable to the **FRONT** jack (or corresponding jack) on the rear panel of your audio breakout box.

The following illustration provides an example of typical connections to an external audio breakout box:

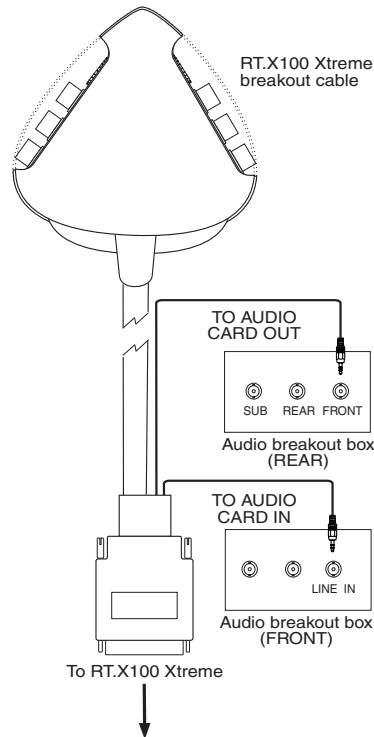

Note If the audio input and output cables on your RT.X100 Xtreme breakout cable aren't long enough to reach your audio breakout box, simply use extension cables. These can be purchased at any electronics store.

3. Typical RT.X100 Xtreme connections

The following illustrations show some typical audio and video connections for capturing and printing to tape. If you require a typical studio setup, you can quickly set up your editing system by referring to these illustrations. For more details on how to connect your devices, see “4. Connect your DV-1394 device” on page 26 and “5. Connect your composite and S-Video devices” on page 27.



Note In these illustrations, we’ve connected a video monitor (NTSC or PAL) to view the signal that is being captured or recorded, and we’re monitoring audio from the sound card to the computer speakers (requires you to connect the small connectors to the corresponding jacks of your computer’s sound card, and your computer speakers to the **AUDIO** jack of the RT.X100 Xtreme card as explained on page 20).

DV-1394 connections

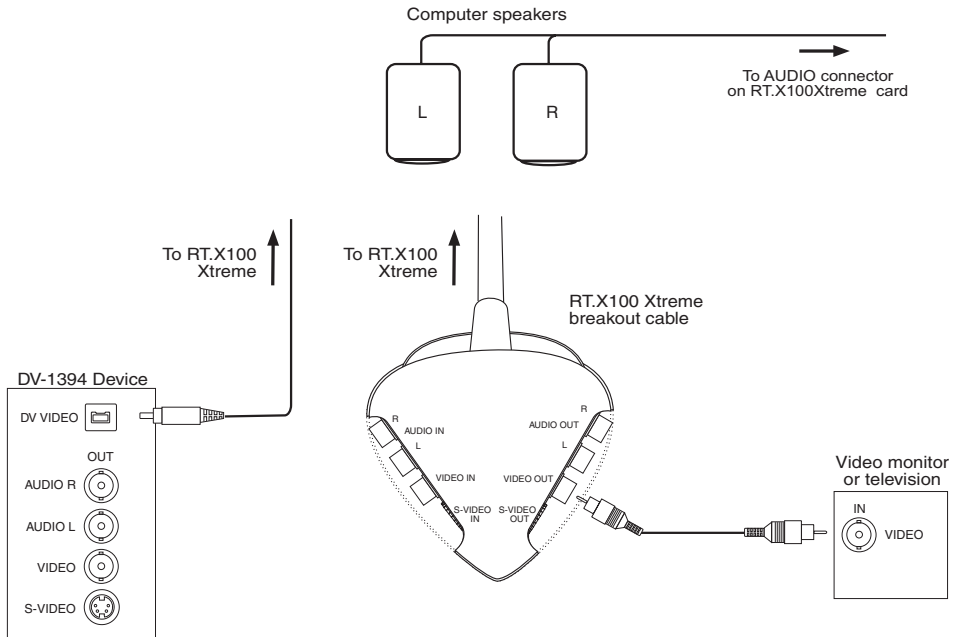

S-Video connections using same device for capture and print-to-tape

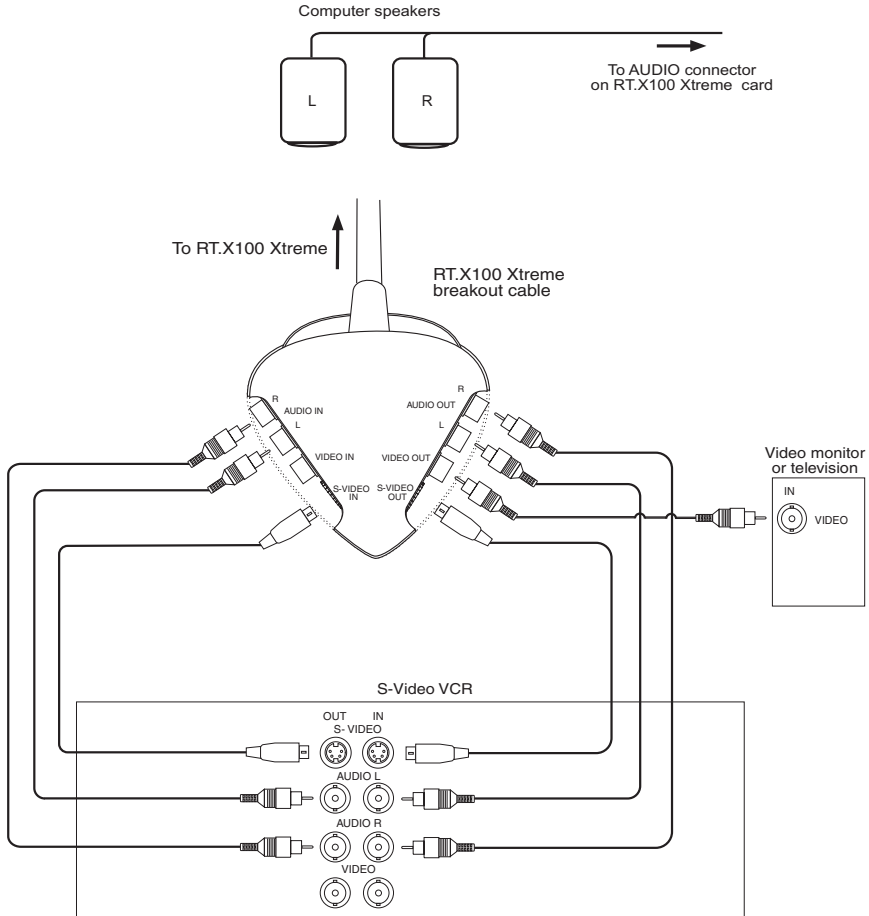

Composite connections using separate source and record devices

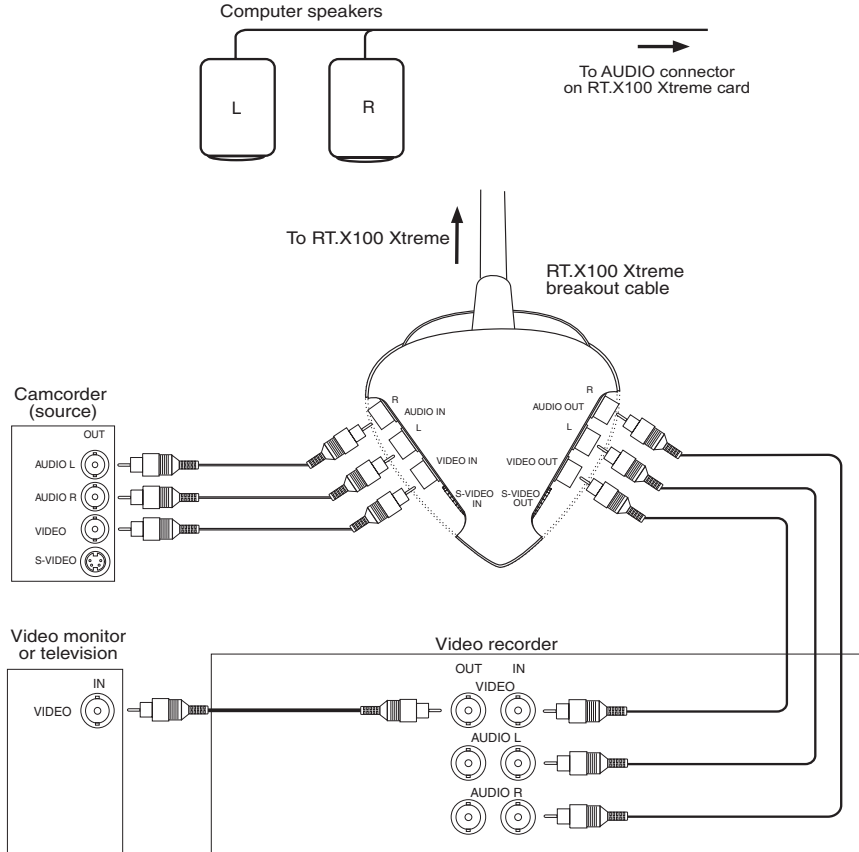

4. Connect your DV-1394 device

Use the supplied 4-to-6 pin cable to plug your DV-1394 device (such as a DV camcorder or DV deck) into the 1394 connector on the RT.X100 Xtreme card. The 4-to-6 pin cable will work with most DV devices. Some DV-1394 devices have 6-pin connectors (in this case, you'll have to supply your own 6-to-6 pin cable). For a list of compatible DV-1394 devices, see the RT.X Support section of our web site at www.matrox.com/vidoweb/support.



Caution Use extra care when plugging in or unplugging the 4-to-6 pin connector. It's very easy to bend the connector pins inside your DV-1394 device, rendering it useless. Use only minimal force.

- 1 Plug the 4-pin end of the cable into your DV-1394 device.
- 2 Plug the 6-pin end of the cable into the 6-pin 1394 connector on your RT.X100 Xtreme card.

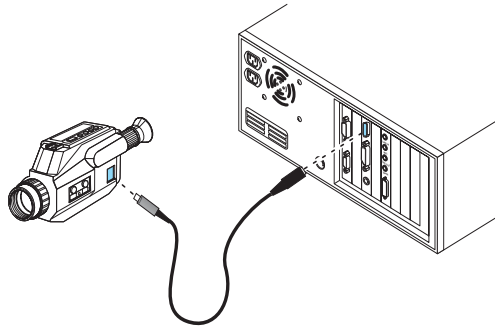

Note In Windows XP, the first time you plug in your DV-1394 device, the **Digital Video Device** dialog box prompts you to select what you'd like Windows to do. To avoid having this dialog box appear every time you connect your DV-1394 device, click **Take no action**, select **Always perform the selected action**, then click **OK**.

Hot-plugging

Your DV-1394 device can be plugged into or unplugged from the RT.X100 Xtreme card at any time; there's no need to turn off your computer when connecting or removing your device.



Important When connecting your DV-1394 device, make sure it is turned off. Once you've connected your device, you can turn it on and it will be ready for use. Do not try to swap DV-1394 devices while performing a capture in Adobe Premiere.

5. Connect your composite and S-Video devices

The RT.X100 Xtreme breakout cable has two composite video connectors (one input and one output), and two S-Video connectors (one input and one output). Most video equipment uses composite video, but some devices (for example, S-VHS VCRs) use S-Video, which provides a higher quality video signal.

If you have a video device with S-Video connectors, you should use the Matrox **S-VIDEO** in and out connectors on your breakout cable. You can use the Matrox S-Video connectors instead of—or in addition to—the composite video connectors. If you use composite and S-Video connectors, you can connect up to four video devices to RT.X100 Xtreme at the same time (two input and two output).

RT.X100 Xtreme video output is *simultaneous* on its composite (**VIDEO**) and S-Video (**S-VIDEO**) lines. Both video input types can be connected at the same time, but only *one* video input signal at a time can be used by RT.X100 Xtreme. You need to select either the composite video input or the S-Video input signal in Adobe Premiere. For more information, see [“Defining your Capture settings”](#) on page 55.

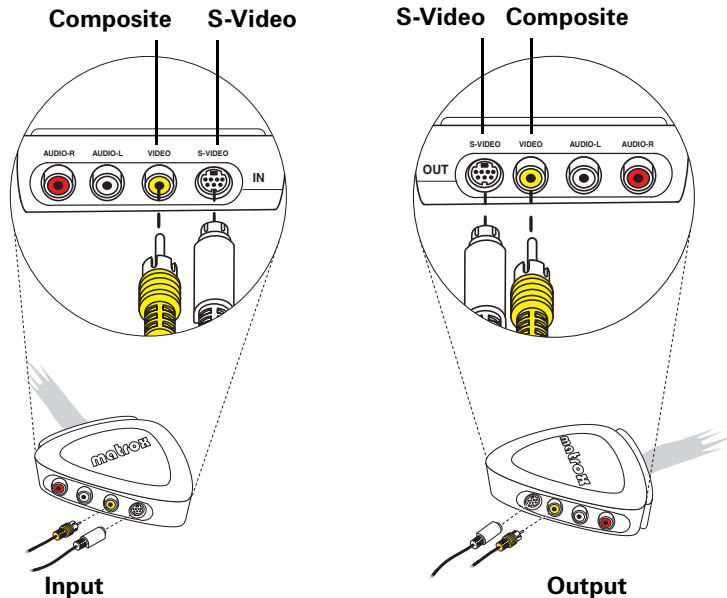

Composite input/output connections

- 1 To connect your composite video source (for capturing material), use either a composite audio/video (RCA) cable or three separate cables with RCA connectors. On the input side (**IN**) of your breakout cable:
 - a Connect the video output from your composite device to the yellow **VIDEO** jack.
 - b Connect the left audio output channel of your device to the white **AUDIO-L** jack.
 - c Connect the right audio output channel of your device to the red **AUDIO-R** jack.

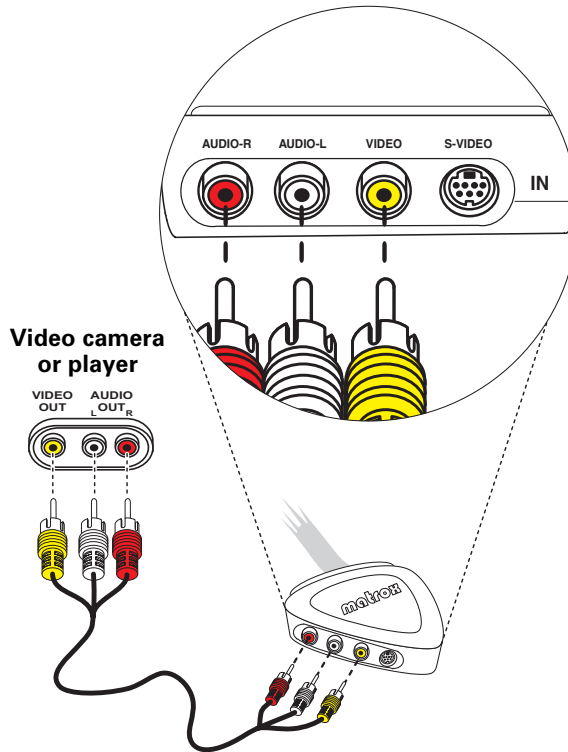

- 2 To connect your composite video recorder, use another composite (RCA) audio/video cable or three more separate cables with RCA connectors. On the output side (**OUT**) of your breakout cable:
 - a Connect the yellow **VIDEO** jack to the video input on your video recorder.
 - b Connect the white **AUDIO-L** jack to the left audio input of your video recorder.
 - c Connect the red **AUDIO-R** jack to the right audio input of your video recorder.

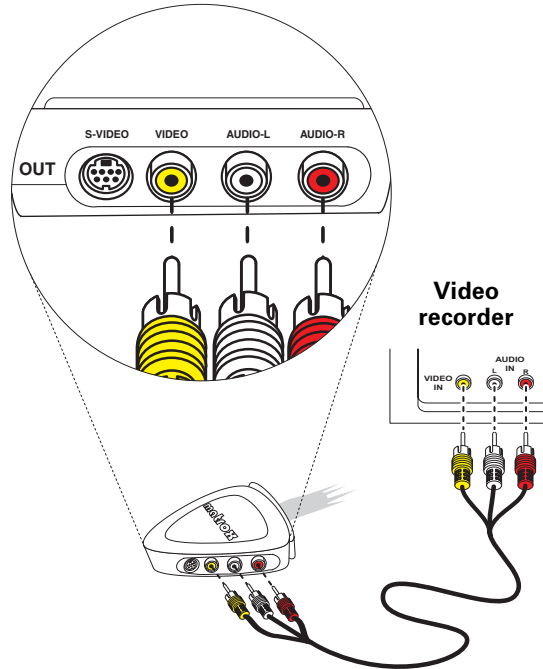

- 3 To display the output from Matrox RT.X100 Xtreme on your NTSC or PAL video monitor¹, you can connect your video monitor to the breakout cable or your recorder. For an illustration of typical composite connections that you can use, see [“Composite connections using separate source and record devices”](#) on page 25.

¹ You can use a TV in place of an NTSC or PAL video monitor. If your TV has a TV/VIDEO input switch, set it to VIDEO.

5. Connect your composite and S-Video devices

S-Video input/output connections

- 1 To connect your S-Video source (for capturing material), use an S-Video cable, as well as two cables with RCA connectors for audio. On the input side (**IN**) of your breakout cable:
 - a Connect the video output from your S-Video device to the **S-VIDEO** jack.
 - b Connect the left audio output channel of your device to the white **AUDIO-L** jack.
 - c Connect the right audio output channel of your device to the red **AUDIO-R** jack.



Note If your video device has only one audio connector, use the left audio connector on the cable.

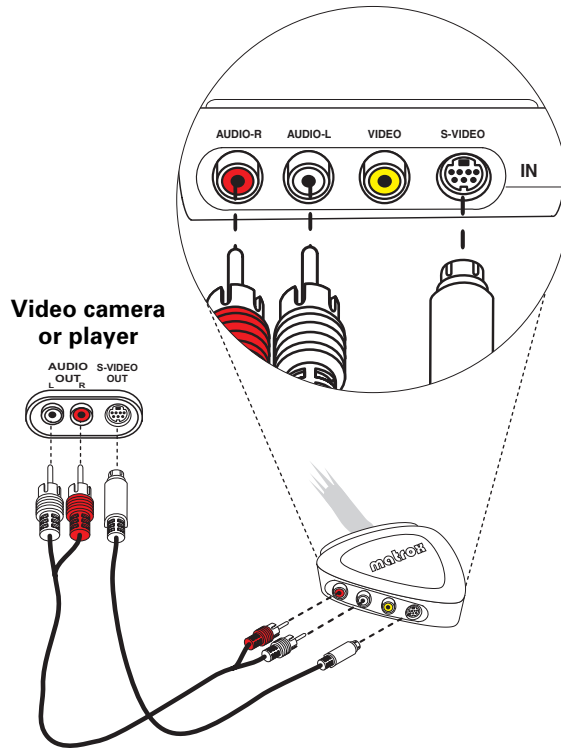

- 2 To connect your S-Video recorder, use another S-Video cable and two more cables with RCA connectors for audio. On the output side (**OUT**) of your breakout cable:
 - a Connect the **S-VIDEO** jack to the video input on your video recorder.
 - b Connect the white **AUDIO-L** jack to the left audio input of your video recorder.
 - c Connect the red **AUDIO-R** jack to the right audio input of your video recorder.

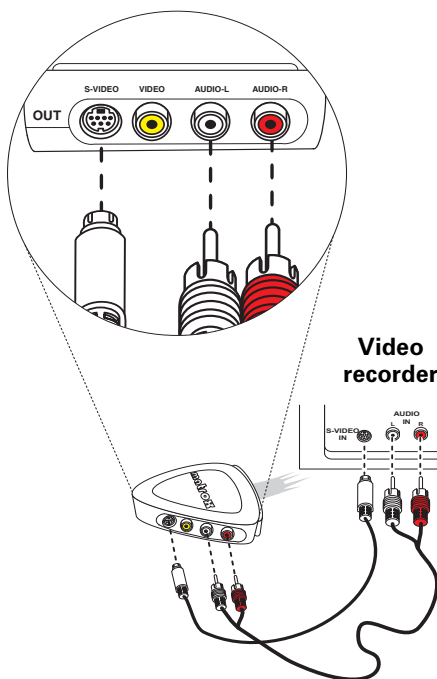

- 3 To display the output from Matrox RT.X100 Xtreme on your NTSC or PAL video monitor¹, you can connect your video monitor to the breakout cable or your recorder. For an illustration of typical S-Video connections that you can use, see [“S-Video connections using same device for capture and print-to-tape”](#) on page 24.

¹ You can use a TV in place of an NTSC or PAL video monitor. If your TV has a TV/VIDEO input switch, set it to VIDEO.

5. Connect your composite and S-Video devices

Are you ready?

Before installing the software for your RT.X100 Xtreme system as explained in the next chapter, go back over the steps in this chapter and make sure you've completed all necessary operations.

Have you...

- Installed your Matrox RT.X100 Xtreme card?
- Connected your RT.X100 Xtreme breakout cable and computer speakers?
- Connected your DV-1394 device, if applicable?
- Connected your composite and S-Video devices, if applicable?

4

Installing Your Matrox RT.X100 Xtreme Software

This chapter explains how to install the software required to use your Matrox RT.X100 Xtreme, including Matrox X.tools and other software.

Before you begin

Before proceeding with this chapter, make sure you've prepared your computer as instructed in the preceding chapters. This includes:

- Preparing your system.
 - Plan your storage configuration and install your A/V drive(s).
 - Install Windows XP or Windows 2000.
 - Configure your Windows display for a resolution of 1024×768 (or higher) with 16- or 32-bit color.
 - Install and configure your sound card.
 - Install Adobe Premiere, and any third-party software for which you want to install a Matrox plug-in.
- Installing your RT.X100 Xtreme card and connecting your devices.

Overview of the software installation

Once you've installed your Matrox RT.X100 Xtremecard and properly connected your devices, you can proceed with the software installation. The following list provides an **overview** of the steps required. These steps are explained in greater detail in this chapter:

- 1 Hardware detection. See the next section.
- 2 Install Matrox X.tools. See page 35.
- 3 Register your RT.X100 Xtreme. See page 36.
- 4 Install additional software from the RT.X menu. See page 36.
- 5 Install Sonic Solutions DVDIt! SE. See page 38.
- 6 Install Sonic ReelDVD Studio. See page 38.

1. Hardware detection

Turn on your computer. Once Windows restarts, the “Found New Hardware Wizard” detects your RT.X100 Xtreme card. Because the Matrox X.tools Setup program will automatically detect your devices and install the appropriate drivers, simply press **ESC** or click **Cancel** to close the “Found New Hardware Wizard.” You may have to repeat this procedure several times.



Note The “Found New Hardware Wizard” will only appear the first time you start your computer after installing your RT.X100 Xtreme card.

2. Install Matrox X.tools

- 1 Insert your Matrox RT.X installation CD in your CD-ROM drive. Windows automatically starts the Matrox RT.X menu.

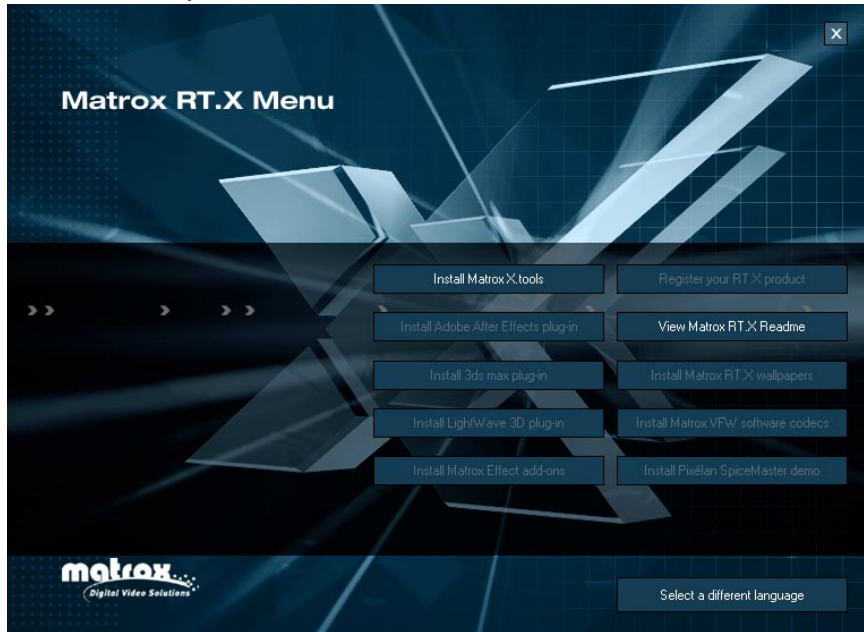

- 2 From the Matrox RT.X menu, choose **Install Matrox X.tools**.
- 3 Follow the onscreen instructions to install Matrox X.tools on your computer.

Remarks

- To change the language in which you want to run the X.tools Setup program, choose **Select a different language**. All the Matrox RT.X100 Xtreme dialog boxes and Help files will be displayed in English (if you install X.tools in English, French, German, Italian, or Spanish), or Japanese (if you install X.tools in Japanese). The Matrox Effect add-ons and corresponding Help files are available in English only.
- If you'd like to be able to switch your video standard without re-installing Matrox X.tools, select **Install all files to be able to switch the video standard without re-installing X.tools** when prompted. When you want to switch your video standard, choose **Start > Programs > Matrox X.tools > Switch Your Video Standard**.
- If you choose to install the Matrox Effect add-ons, select the effects you want to install, and follow the onscreen instructions. You can also install the add-ons from the Matrox RT.X menu at a later time (see [“4. Install additional software from the RT.X menu”](#) on page 36).

2. Install Matrox X.tools

- 4 When the Matrox X.tools software installation is complete, you'll be prompted to restart your computer for the changes to take effect.
- 5 Click **OK** to restart your computer. You can then register your Matrox RT.X100 Xtreme as explained in the next section.

3. Register your RT.X100 Xtreme

When your computer restarts, you can choose **Register your RT.X product** from the RT.X menu to register your RT.X100 Xtreme online. You must register your RT.X100 Xtreme in order to be eligible for customer support and free software updates.

If you don't want to register at this time, you can register later by choosing **Start > Programs > Matrox X.tools > Register Your RT.X Product**. You can also register in the RT.X Support section of our web site at www.matrox.com/videoweb/support.

4. Install additional software from the RT.X menu

After installing Matrox X.tools, you can choose to install additional software from the RT.X menu at any time, including Matrox WYSIWYG (What You See Is What You Get) plug-ins and Matrox Effect add-ons:

- **Adobe After Effects plug-in** Lets you display the contents of your Composition window in Adobe After Effects (version 4.0 or later) on your video monitor.
- **3ds max plug-in** Lets you display your 3ds max (version 4.0) animation on your video monitor.
- **LightWave 3D plug-in** Lets you display your LightWave 3D (version 6.0 or later) animation on your video monitor. Once you've installed this plug-in, you'll need to add it to LightWave 3D as explained in the next section, "[Adding the Matrox plug-in to LightWave 3D](#)."
- **Matrox Effect add-ons** Includes many additional effects for your RT.X100 Xtreme system, such as ripples, mesh warps, and twirls. These effects will be added to your other realtime Matrox effects for Adobe Premiere. For details on how to set up an add-on effect, see the effect's online Help (available in English only).



Note To install the Matrox plug-in for a program, you must first install that program (such as 3ds max).

⇒ **To install additional software from the RT.X menu:**

- 1 Insert your Matrox RT.X installation CD in your CD-ROM drive. Windows automatically starts the Matrox RT.X menu.
- 2 From the Matrox RT.X menu, choose the option you want, such as **Install Matrox RT.X wallpapers**, and follow the onscreen instructions.

Adding the Matrox plug-in to LightWave 3D

When you install the Matrox plug-in for LightWave 3D, the plug-in is copied to your hard drive. You must then add the plug-in to LightWave 3D as follows:

- 1 Start LightWave 3D.
- 2 Do one of the following:
 - If you have LightWave 3D v6.0 or 6.5, choose **Extras > Add Plug-ins**.
 - If you have LightWave 3D v7.0, choose **Layout > Plug-ins > Add Plug-ins**.
- 3 Open the **Animate** folder, and double-click the *mveLightWave.p* file.
- 4 Click the **OK** button in the **Add Plug-ins** dialog box.

Installing the Matrox VFW software codecs on a system without the RT.X100 Xtreme hardware

The Matrox VFW software codecs let you render (compile) and play back RT.X100 Xtreme-compatible *.avi* files in your Video for Windows programs without having the RT.X100 Xtreme hardware installed in your computer.



Note If you have the RT.X100 Xtreme hardware, you do **not** need to install the VFW software codecs because Matrox X.tools installs all the required Matrox codecs on your system.

⇒ **To install the Matrox VFW software codecs:**

- 1 Close all Windows programs.
- 2 Insert your Matrox RT.X installation CD in your CD-ROM drive.
- 3 From the Matrox RT.X menu, choose **Install Matrox VFW software codecs**.
- 4 Follow the onscreen instructions. An information box indicates when the installation is complete.



Important If you later decide to install the RT.X100 Xtreme hardware in your computer, you must remove the Matrox VFW software codecs from your system (using **Add/Remove Programs** in Windows Control Panel) **before** installing your RT.X100 Xtreme hardware and software.

5. Install Sonic Solutions DVDIt! SE

To install Sonic Solutions DVDIt! SE:

- 1 Close all Windows programs.
- 2 Insert the DVDIt! SE installation CD in your CD-ROM drive.
- 3 When the setup program starts, follow the onscreen instructions. If Windows doesn't automatically start the setup program, you can start it manually as follows:
 - a Choose **Start > Run**.
 - b In the resulting dialog box, type *e:\setup* (where *e:* represents your CD-ROM drive), and click **OK**.

For information on DVDIt! SE, see [Chapter 13, "Using Sonic DVDIt! SE,"](#) on page 239.

6. Install Sonic ReelDVD Studio

To install Sonic ReelDVD Studio:

- 1 Close all Windows programs.
- 2 Insert the ReelDVD Studio installation CD in your CD-ROM drive.
- 3 When the setup program starts, follow the onscreen instructions. If Windows doesn't automatically start the setup program, you can start it manually as follows:
 - a Choose **Start > Run**.
 - b In the resulting dialog box, type *e:\setup* (where *e:* represents your CD-ROM drive), and click **OK**.
- 4 When the ReelDVD Studio software installation is complete, you'll be prompted to restart your computer for the changes to take effect.
- 5 Click **Finish** to restart your computer.



Note To activate ReelDVD Studio, you must click **Register** the first time you start ReelDVD Studio, and register your copy of ReelDVD Studio online. For more information, refer to your ReelDVD documentation.

Removing your Matrox RT.X100 Xtreme software

You can remove the Matrox X.tools software from your computer at any time by choosing **Start > Programs > Matrox X.tools > Uninstall**. Uninstalling Matrox X.tools removes the Matrox realtime plug-in for Adobe Premiere, as well as Matrox MediaExport, Matrox MediaTools, and the WYSIWYG DirectShow Control Panel. When you uninstall Matrox X.tools, you'll be prompted if you want to also uninstall the Matrox Effect add-ons.



Note If Windows prompts you with a **Shared File Detected** message during the uninstall, choose **Yes** to delete the file, and select **Don't display this message again**.

If you want to uninstall only the Matrox Effect add-ons, choose **Start > Programs > Matrox X.tools > Add-ons > Uninstall Matrox Effect add-ons**. If you want to remove any other Matrox software, such as a Matrox WYSIWYG plug-in or the Matrox RT.X wallpapers, use **Add/Remove Programs** in Windows Control Panel.

Are you ready?

Before defining your Adobe Premiere settings for use with Matrox RT.X100 Xtreme, as explained in the next chapter, go back over the steps in this chapter and make sure you've completed all necessary operations.

Have you...

- Installed Matrox X.tools?
- Registered your RT.X100 Xtreme?
- Installed additional software, if required?

Your notes

5

Defining Your Adobe Premiere Settings

This chapter explains how to define various settings for using your Matrox RT.X100 Xtreme with Adobe Premiere. This includes specifying your project and export movie settings, and setting up DV-1394 device control.

A note about running other programs with Adobe Premiere

For the best performance, don't run any other programs at the same time as Adobe Premiere. Screen savers and programs that use a large amount of system memory, such as most paint and compositing applications, can cause problems if you run them at the same time as Adobe Premiere.

Loading project presets

The Matrox realtime plug-in for Adobe Premiere includes project presets that you can load to immediately apply appropriate RT.X100 Xtreme settings.

⇒ To load an RT.X100 Xtreme project preset:

- 1 Start Adobe Premiere. The **Load Project Presets** dialog box appears.
- 2 From the **Matrox DV** folder, select the preset, such as **DV (DV-1394 Input)**, that matches the type of project you want to create.
- 3 Click **OK** to apply the settings. You can customize your project settings as explained in the following sections.

Setting up your scratch disks

When specifying the location of your scratch disks in Adobe Premiere, make sure you follow the recommendations in your *Adobe Premiere User Guide*. For example, store your video and audio files on an A/V drive used exclusively for that purpose.

⇒ To specify your scratch disks:

- 1 Choose **Edit > Preferences > Scratch Disks and Device Control**.
- 2 Under **Scratch Disks**, select an A/V drive for **Captured Movies**, **Video Previews**, and **Audio Previews**.
- 3 Click **OK** to save your preferences.

Remarks

- If you switch your video standard (as explained on [page 35](#)), you'll have to set up your scratch disks again.
- For information on setting up device control for your DV camera or deck, see "[Setting up DV-1394 device control](#)" on [page 69](#).

Setting your low disk space warning level

Before you perform an export to disk in Premiere, you must have enough disk space for your exported project. If you have low disk space during an export, Premiere can become unstable. To avoid this problem, you should specify a high

low disk space warning level. This will enable you to delete files when you're warned, and resume the export.



To set your low disk space warning level:

- 1 Choose **Edit > Preferences > General and Still Image**.
- 2 In the **Low Disk Space Warning Level** box, enter a high warning level, such as 100000 K.
- 3 Click **OK** to return to your project.

Defining your General settings

The **Matrox Advanced Settings** dialog box has several pages that you can use to specify various settings for editing in Adobe Premiere on Matrox RT.X100 Xtreme.



To specify your General settings on Matrox RT.X100 Xtreme:

- 1 Choose **Project > Project Settings > General**.
- 2 From the **Editing Mode** list, select **Matrox RT.X**.
- 3 Click the **Advanced Settings** button. By default, the **General** tab is displayed.



- 4 Under **Analog Setup (NTSC)**, select the setup level you want for your NTSC analog video. For example, select **0 IRE (DV-compliant)** when using DV-1394 devices that follow the Japanese NTSC standard. For details, see [“Selecting your NTSC setup level for analog video”](#) on page 44.
- 5 Under **Editing Aspect Ratio**, select the aspect ratio that matches your source material. For example, select **4:3** if your video was recorded using the standard TV screen format. For details, see [“Selecting your editing aspect ratio”](#) on page 46.
- 6 Under **Scrubbing Type**, you can switch between **Field 1** and **Field 2**. You may want to do this, for example, if you see “glitches” when playing back

your Timeline that don't appear when you subsequently scrub on the Timeline. For details, see [“Switching between scrubbing types”](#) on page 46.

- 7 Under **Error Reporting**, select **Report dropped frames** if you want to be warned each time frames are dropped when you play back video from the Timeline. Otherwise, clear this option.



Note Once playback of the Timeline has stopped, a red bar will appear over segments of the Timeline that have dropped frames (even if you don't select **Report dropped frames**). To perform a Matrox realtime export to disk or export to DV tape, you must first render the segments identified by the red bar. If you close your project before rendering, the red bar won't re-appear when you re-open the project.

- 8 Under **Speed Change Processing**, select how realtime speed changes are to be processed. **Blend fields** typically works well on standard and slow-paced video, and **Repeat fields** typically works well on fast-action video. For details, see [“Selecting your speed control method”](#) on page 47.
- 9 Click **OK** to save your settings and return to the **Project Settings** dialog box. You can specify additional General settings as explained in your *Adobe Premiere User Guide*.

Selecting your NTSC setup level for analog video

Most commercial DV cameras that have a 1394 interface follow the Japanese specification for analog NTSC video, where the black level (setup) is 0 IRE. The standard setup level for analog NTSC video in North America, however, is 7.5 IRE.

The black level used for the digital bit stream is the same for both Japanese and North American video equipment. This means that when you capture DV video over the 1394 interface on Matrox RT.X100 Xtreme, the video is captured at the correct black level. When you play back the captured clips on your NTSC monitor, however, you may find that the video appears too bright or colors appear to be washed out. This is because the default setup level for the analog output of Matrox RT.X100 Xtreme is 7.5 IRE, whereas your DV camera's analog output uses the Japanese setup level of 0 IRE.

⇒ **To change the setup level of your analog NTSC video on Matrox RT.X100 Xtreme:**

- 1 Choose **Project > Project Settings > General**.
- 2 Click the **Advanced Settings** button.



- 3 Under **Analog Setup (NTSC)** on the **General** page, select one of the following setup levels. This affects both the analog video input and output.
 - **0 IRE (DV-compliant)** Applies a setup level of 0 IRE. You should select this option only when working with a commercial DV-1394 device that uses the Japanese analog NTSC setup of 0 IRE. For example, if the video appears too bright when you play back DV clips on your NTSC monitor, you can change the setup to 0 IRE to output your DV clips at the correct brightness.
 - **7.5 IRE** Applies the standard NTSC setup level of 7.5 IRE.



Note If your DV-1394 device has a different NTSC setup level for input and output, you can switch the setup level as needed before capturing clips or exporting to tape. If you're not sure which setup level your DV-1394 device uses for input and output, check with your device's manufacturer.

- 4 Click **OK** to return to the **Project Settings** dialog box. Your new setup level will take effect only after you restart your computer.

Selecting your editing aspect ratio

To specify the aspect ratio of the material you're editing on Matrox RT.X100 Xtreme:

- 1 Choose **Project > Project Settings > General**.
- 2 Click the **Advanced Settings** button.



- 3 Under **Editing Aspect Ratio** on the **General** page, select the aspect ratio that matches your source material. This ensures that your effects will be displayed with the correct proportions.
 - **4:3** Select this if your video was recorded using the standard TV screen format.
 - **16:9** Select this if your video was recorded using the widescreen 16:9 format.

i **Important** If the editing aspect ratio isn't set correctly, certain effects may appear distorted (that is, squeezed or stretched horizontally). Make sure you create all animations, titles, and graphics for your production using the same aspect ratio as your source video. For example, when creating your own organic wipe patterns for use in a widescreen production, make sure you create your organic wipes with a 16:9 aspect ratio. For more information, see [“Creating a production in 16:9 format”](#) on page 77.

- 4 Click **OK** to return to the **Project Settings** dialog box.

Switching between scrubbing types

When you play back the Timeline, both fields of each frame are displayed. When you scrub the Timeline, however, only one field is displayed. As well, only one field is displayed when you pause or stop playback on the Timeline. For example, if you see a “glitch” in your project when you play it back from the Timeline, but notice that when you scrub on the Timeline to find the glitch, you can't find it, you may need to switch the field you're scrubbing over. You can then return to your Timeline and find the problem by scrubbing.

⇒ **To change your scrubbing type:**

- 1 Choose **Project > Project Settings > General**.
- 2 Click the **Advanced Settings** button.

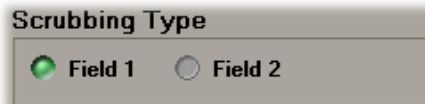

- 3 Under **Scrubbing Type** on the **General** page, select either **Field 1** or **Field 2**.
- 4 Click **OK** to return to the **Project Settings** dialog box, then click **OK** again to return to the Timeline.
- 5 When you scrub the Timeline, or pause or stop playback on the Timeline, only the particular field you selected will be displayed.

Selecting your speed control method

Your Matrox RT.X100 Xtreme provides two methods of processing realtime speed changes in your Premiere projects. Depending on whether most of your project is slow-paced video or fast-action video, you can choose the type of speed control that's best suited for your video project.

⇒ **To specify your speed control method:**

- 1 Choose **Project > Project Settings > General**.
- 2 Click the **Advanced Settings** button.



- 3 Under **Speed Change Processing** on the **General** page, select one of the following:
 - **Blend fields** Interpolates between the video fields, and typically works well on standard or slow-paced video and camera pans.
 - **Repeat fields** Mimics the classic “bob and weave” algorithm found on Betacam machines, and typically works well on fast-action video.



Note The speed change processing option you select applies to **all** speed changes in your current project. Therefore, select the option that best suits the type of video you use most often in your project. For details on how to apply speed changes to your clips, see your *Adobe Premiere User Guide*.

- 4 Click **OK** to return to the **Project Settings** dialog box.

Selecting your codec options for rendering

On the **Codec (Rendering)** page of the **Matrox Advanced Settings** dialog box, you can choose whether or not you want Matrox RT.X100 Xtreme to show your render results in Premiere's **Monitor** window, as well as select your color space conversion options.

When you render material in your Adobe Premiere project on Matrox RT.X100 Xtreme, such as preview files for non-realtime effects, you can determine how you want the chroma information to be processed during the color space conversion that's performed during the render.



Note The default settings for color space conversion provide good results for most applications. We recommend that you change these settings only when needed for special purposes.



To select your codec options for rendering:

- 1 Choose **Project > Project Settings > General**.
- 2 Click the **Advanced Settings** button, then click the **Codec (Rendering)** tab.

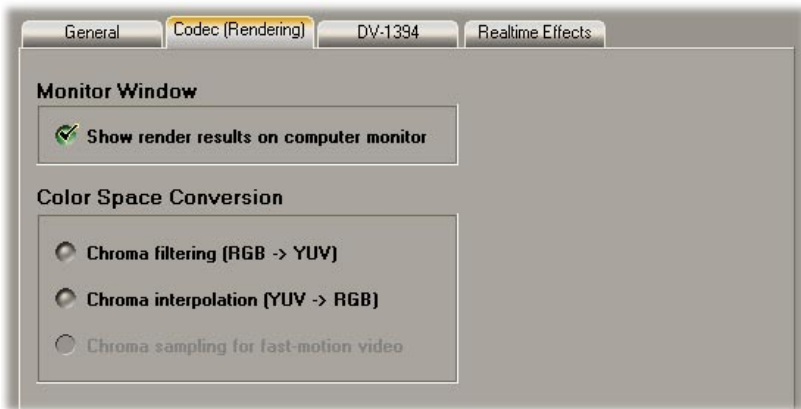

- 3 Under **Monitor Window**, select **Show render results on computer monitor** if you want to view your render results in Premiere's **Monitor** window. You can clear this option to improve the speed of rendering.
- 4 Under **Color Space Conversion**, select the options you want:
 - **Chroma filtering** and **Chroma interpolation** Select these options to adjust the chroma bandwidth of RGB graphics. This improves images that have abrupt changes between different colors, such as a blue box on a black or white background. You should select these options for most animation and compositing work (computer-generated material). For most video material, however, it's best that you **not** select these options. If you find that

your rendered images appear to be blurred, try clearing one or both of these options.

- **Chroma sampling for fast-motion video** Select this option to help eliminate artifacts such as jagged edges and unwanted lines at the edges of fast-motion video (for PAL video only).

 **Important** When rendering graphics and titles, make sure that **Chroma sampling for fast-motion video** is **not** selected, as this option can cause jagged edges to appear in your rendered images.

- 5 Click **OK** to return to the **Project Settings** dialog box.

Selecting your DV-1394 settings

On Matrox RT.X100 Xtreme, you can define various settings for working with DV-1394 devices, such as which DV stereo streams you'd like to capture, and the NTSC time code format of your DV tapes.

⇒ **To select your DV-1394 settings:**

- 1 Choose **Project > Project Settings > General**.
- 2 Click the **Advanced Settings** button, then click the **DV-1394** tab.



- 3 Under **Export to Tape**, you should select **Enable video preview during export**. This lets you preview the video you're exporting to tape on your computer monitor. Some systems and DV-1394 devices, however, don't support this option. If you're unable to perform an export to tape, try clearing **Enable video preview during export**. The preview will be disabled on your computer monitor, but you can preview the video on your camcorder's viewfinder and on your NTSC or PAL monitor (assuming you've connected the analog video output of your DV-1394 device to your video monitor).



Note If you clear **Enable video preview during export** after a failed DV-1394 export to tape, you'll need to restart your computer before starting the export to tape again.

- 4 If you want to perform a Matrox realtime export to DV tape, make sure **Enable realtime export to tape** is selected. Some systems, however, may have problems with the realtime export, such as gray blocks or system sluggishness, in which case you'll want to clear this option. For details, see [“Exporting your Timeline to DV tape”](#) on page 71.
- 5 Under **Timeline Playback**, select one of the following:
 - **Enable XtremePreview** Lets you edit and preview many video and graphics layers and effects without having to render (for details, see [“What](#)

is XtremePreview?” on page 169). XtremePreview is disabled when you select **Always output to 1394**.

- **Always output to 1394** Outputs your Timeline over the 1394 interface to your DV-1394 device whenever you play back the Timeline. You’ll be able to preview the output on your NTSC or PAL monitor, as well as on your DV-1394 device’s viewfinder. This feature cannot be used at the same time as XtremePreview.

- 6 Under **1394 Audio Capture**, select which DV stereo audio streams you want to capture. If you capture only one DV stereo stream, the audio stream of your stereo clip will be embedded in your .avi file, creating a single interleaved audio and video file. If you choose to capture both DV stereo streams, the second audio stream will be saved to a separate audio file named *clipID_2ndStream.wav*.

Remarks

- Some DV-1394 devices let you capture only one stereo audio stream. For more information, consult the documentation that came with your DV-1394 device.
 - When capturing audio over the 1394 interface with certain DV devices (such as Sony or Canon), the left and right channels may be inverted in the resulting file. If this happens, you can select **Invert left and right channels** to correct this problem.
- 7 If you have an NTSC system, under **Tape Time Code Format**, select the format that matches the format on your DV tapes.
 - 8 Click **OK** to return to the **Project Settings** dialog box.

Selecting your realtime effect settings

You can specify default cropping settings for your realtime Matrox effects, as well as select which Premiere transitions you'd like to play back in real time. For example, all of the Matrox transitions are realtime, whereas Adobe Premiere's transitions require rendering. With the Matrox realtime plug-in, however, you can select which Adobe Premiere transitions you'd like to play back in real time.

⇒ **To select your realtime effect settings:**

- 1 Choose **Project > Project Settings > General**.
- 2 Click the **Advanced Settings** button, then click the **Realtime Effects** tab.

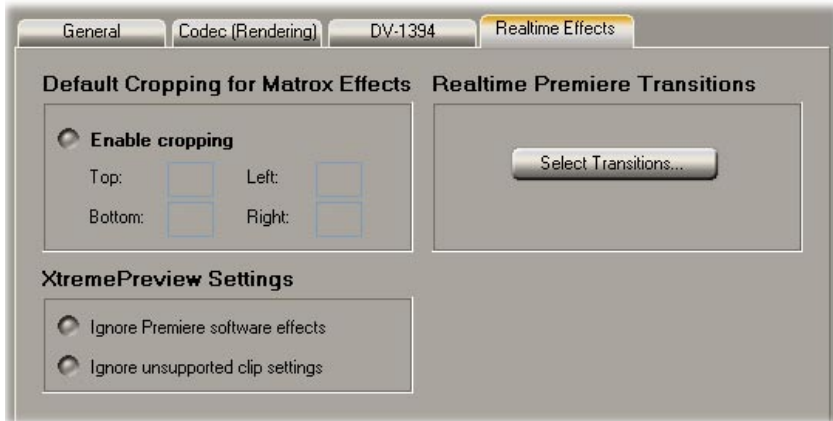

- 3 Under **Default Cropping for Matrox Effects**, select **Enable cropping** and specify in pixels the default cropping values that you want to be applied each time you create an effect using the Matrox realtime plug-in. For example, if garbage video or black lines appear at the left and right edges of your video, you'll want to crop these edges so that they're not visible in your effects. Be aware that your new crop settings will be applied only to subsequent clips you add to the Timeline (that is, clips already on the Timeline won't be affected).

Remarks

- Unless you need cropping to be applied to your clips, make sure that **Enable cropping** is **not** selected. This improves system performance.
- If you've applied cropping, make sure you apply the **same** cropping settings when you perform a Premiere export to disk on your Matrox RT.X100 Xtreme system (see [“Performing a Premiere export to disk”](#) on page 64). If your project and export cropping settings don't match, incorrect cropping will be applied to your Timeline immediately after completing the export. To restore the correct settings, save your project, then quit and restart Premiere.

- 4 Under **Realtime Premiere Transitions**, click the **Select Transitions** button.
- 5 In the provided dialog box, select the transitions you want to play back in real time. Matrox provides realtime playback by emulating Premiere's non-realtime version of these transitions. If you don't like a realtime transition, you can clear (deselect) it to revert to Premiere's version that requires rendering.



Note Some Premiere transitions let you apply various settings that may cause frames to be dropped during realtime playback. If this happens, you should clear those transitions to turn off the realtime playback.

- 6 Under **XtremePreview Settings**, you can choose to ignore Premiere software effects and unsupported clip settings when using XtremePreview. This lets you preview many video and graphics layers with multiple Matrox effects without having to render.
 - **Ignore Premiere software effects** Lets you ignore Premiere video effects and non-realtime transitions.
 - **Ignore unsupported clip settings** Lets you ignore unsupported clip settings in Premiere, such as field processing options applied to a clip.



Note If you don't ignore Premiere software effects and unsupported clip settings, any segments containing these effects or settings on the Timeline will appear as a "not yet rendered" (X) graphic when you play back the Timeline, and you won't be able to preview all sources in these segments when you set up realtime Matrox effects. For more information, see "[What is XtremePreview?](#)" on page 169.

- 7 Click **OK** to return to the **Matrox Advanced Settings** dialog box, then click **OK** again to return to the **Project Settings** dialog box.

Defining your Video settings

Your project's Video settings determine the compression format for playing back video from the Timeline. On Matrox RT.X100 Xtreme, your Timeline's compression format is set to DV/DVCAM at a fixed data rate of 25 Mb/sec.

➔ **To specify your project's Video Settings on Matrox RT.X100 Xtreme:**

1 Choose **Project > Project Settings > Video**.



Note The **Compressor** is automatically set to **Matrox DV/DVCAM**. This codec will be used to render your preview files when playing back non-realtime effects.

2 From the **Frame Rate** list, select **29.97** if you have an NTSC system, or **25** if you have a PAL or SECAM system.

3 From the **Pixel Aspect Ratio** list, select the setting that matches the aspect ratio of the material you're editing:

- **D1/DV NTSC (0.9)** For NTSC material that uses the standard TV screen format.
- **D1/DV NTSC Widescreen 16:9 (1.2)** For NTSC material that uses the widescreen 16:9 format.
- **D1/DV PAL (1.067)** For PAL material that uses the standard TV screen format.
- **D1/DV PAL Widescreen 16:9 (1.422)** For PAL material that uses the widescreen 16:9 format.

4 Click **OK** to save your settings.

Defining your Audio settings

When you set your project's **Editing Mode** to **Matrox RT.X** (see [“Defining your General settings”](#) on page 43), your project's Audio settings are automatically set to **48000Hz, 16 Bit – Stereo, Uncompressed**.

You can specify additional Audio settings as explained in your *Adobe Premiere User Guide*.



Important For the best performance, use only 48 kHz, 16-bits/sample (stereo) audio in Adobe Premiere.

Defining your Capture settings

Matrox RT.X100 Xtreme lets you capture your video to DV/DVCAM format at a fixed data rate of 25 Mb/sec, or to MPEG-2 IBP format at a selected data rate. For example, you can capture to DV/DVCAM format to create *.avi* files for use in your Premiere projects, or capture to MPEG-2 IBP format to create MPEG-2 Elementary (*.m2v*) files for use with the Sonic ReelDVD Studio and DVDit! SE authoring programs.



Important Clips captured to MPEG-2 IBP format are suitable for DVD authoring, but are **not** supported in your Adobe Premiere projects. Only Matrox DV/DVCAM *.avi* files are supported in your Adobe Premiere projects.



To specify your settings for capturing material in Adobe Premiere on Matrox RT.X100 Xtreme:

- 1 Choose **Project > Project Settings > Capture**.
- 2 From the **Capture Format** list, select **Matrox AVI Capture** to capture to DV/DVCAM format, or **Matrox M2V Capture** to capture to MPEG-2 IBP format.



Note DV/DVCAM video is saved to an *.avi* file. MPEG-2 IBP video is saved to an MPEG-2 Elementary (*.m2v*) file.

- 3 If you'll be capturing audio with your video, make sure that both **Capture Video** and **Capture Audio** are selected.



Note Make sure you've correctly set your sound card's volume levels for recording and playback as explained in the section "[Set your volume levels](#)" on page 13.

- 4 To select the audio and video sources from which you want to capture material, click the **A/V Inputs** button.



- 5 From the **Video Source** list, select **Composite**, **S-Video (Y/C)**, or **DV-1394**. For example, to capture your composite input to Matrox RT.X100 Xtreme, select **Composite**. To capture material from your DV-1394 device over the 1394 interface, select **DV-1394**. If you want to capture material from your DV camera or deck using device control over the 1394 interface, you must set up the device control as explained in the section “[Setting up DV-1394 device control](#)” on page 69. If you don’t set up this device control, you can capture your clips by manually controlling your DV-1394 device.



Note If you selected **DV-1394** as your video source and you set the **Capture Format** to **Matrox AVI Capture**, video will be captured in native DV format over the 1394 interface.

- 6 If you selected an analog video source, you must also select the audio source from which you want to capture material from the **Analog Audio Source** list. Your audio source **must** match your audio input (that is, where you’ve connected the light blue connector labeled **TO AUDIO CARD IN** on your breakout cable, as explained on [page 20](#). For example, if you plugged the **TO**

AUDIO CARD IN connection into the **Line-In** jack (or corresponding jack) on your sound card, choose **Line-In** from the **Analog Audio Source** list.

Remarks

- All supported audio sources will appear in the **Analog Audio Source** list, but in most cases the recommended source will be the default. If your audio input connection does not appear in the list, you must unplug the **TO AUDIO CARD IN** connector on your breakout cable and connect it to an audio input on your sound card that appears in the list.
 - If your analog audio source appears with an * beside it in the list, your sound card does not have matching audio inputs and outputs. In this case, choose the audio source with an * that matches your audio input, make sure that your source is playing back audio, and click **Advanced Settings**. In the provided dialog box, select an **Analog Audio Passthrough**. If you can hear audio, then you've selected the correct analog audio source and passthrough. If you can't hear audio, try selecting a different analog audio source and/or passthrough.
- 7** If you selected **DV-1394** as your video source, select which DV stereo audio streams you want to capture. If you capture only one DV stereo stream, the audio stream of your stereo clip will be embedded in your *.avi* file, creating a single interleaved audio and video file. If you choose to capture both DV stereo streams, the second audio stream will be saved to a separate audio file named *clipID_2ndStream.wav*.

Remarks

- Some DV-1394 devices let you capture only one stereo audio stream. For more information, consult the documentation that came with your DV-1394 device.
 - When capturing audio over the 1394 interface with certain DV devices (such as Sony or Canon), the left and right channels may be inverted in the resulting file. If this happens, you can select **Invert left and right channels** to correct the problem.
- 8** Under **Source Type**, specify the type of analog equipment you're using:
- **Broadcast-quality** Select this if your source device is broadcast-quality, such as a device with a built-in time base corrector (TBC). This allows RT.X100 Xtreme to digitize the input signal as-is.
 - **Consumer-quality** Select this if your source device doesn't have a time base corrector or meet broadcast-quality standards. RT.X100 Xtreme will then filter the input signal to increase tolerance for sync pulse instability.
- 9** Under **VCR Tracking**, the **Tight** setting gives you the best results with most analog source tapes. When using poor-quality analog tapes, select **Looser** to improve the video playback, similar to when you adjust the tracking on your home VCR.

- 10 Click **OK** to return to the **Project Settings** dialog box.
- 11 To adjust the proc amp settings for the analog (S-Video or composite) video that you'll be capturing, click the **Proc Amps** button.

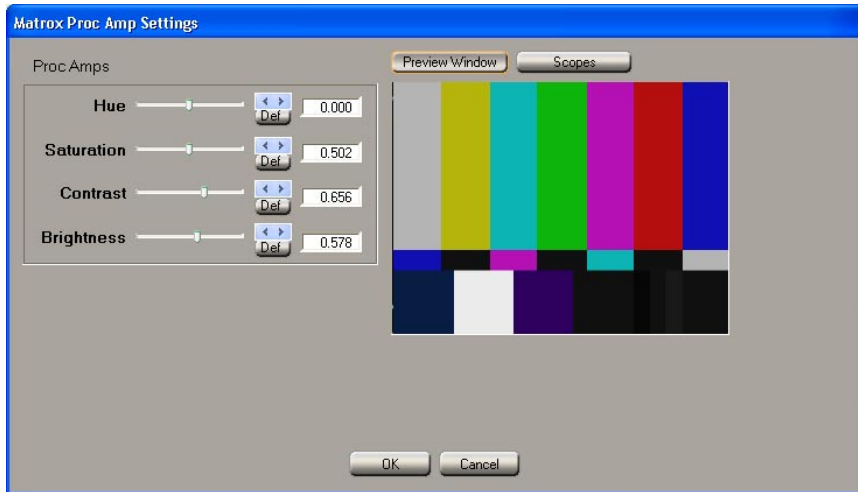

Note Once you've captured your video clips, you can apply proc amp changes and other color corrections to your clips on the Timeline using the Matrox color correction effect. For details, see [“Applying a pre-created color correction”](#) on page 107.

- 12 Use the proc amp controls as needed to adjust the incoming analog video signal before starting the capture. To return a control to its factory default setting, click the **Def** button. You can use the Matrox scopes to analyze your analog signal. For details on how to use the Matrox scopes to check the adjustments you make to the proc amp settings, see [“Using the Matrox scopes to analyze your analog video”](#) on page 59.
 - **Hue** Adjusts the tint of the colors in the image.
 - **Saturation** Adjusts the saturation (vividness) of the image's colors.
 - **Contrast** Adjusts the difference in luminance between the lightest and darkest areas of the image.
 - **Brightness** Adjusts the level of black in the image.



Important To make accurate adjustments to the color of your video clips, always refer to the picture on your NTSC or PAL video monitor instead of the picture in the **Preview Window**.

- 13 Click **OK** to save your proc amp changes and return to the **Project Settings** dialog box.
- 14 To configure your MPEG-2 IBP settings, click the **Format** button. For details on the available settings, see [“Selecting your MPEG-2 IBP settings”](#)

on page 67. Once you've configured your MPEG-2 IBP settings, click **OK** to return to the **Project Settings** dialog box.

You can specify additional Capture settings as explained in your *Adobe Premiere User Guide*.

Using the Matrox scopes to analyze your analog video

The Matrox vectorscope/waveform monitors in the **Matrox Proc Amp Settings** dialog box are software oscilloscopes that let you examine the video signal components of your incoming analog video before you start capturing. The Matrox scopes offer various tools for analyzing different aspects of your video (they do not affect the video signal itself). If any adjustments are necessary based on the results, you can use the proc amp controls to make these adjustments.



Note Because your analog video is converted to a digital signal when input to RT.X100 Xtreme, the Matrox vectorscope and waveform values provide an analysis of your video in digital format only. Therefore, you can't analyze the blanking, sync, or color burst signals. Be aware that the values for the digital signal may vary slightly from those of the analog signal output from RT.X100 Xtreme (converted from digital back to analog).

In the following sections we explain:

- How to select and view the various scopes.
- What each scope does.
- How to use the scopes to calibrate your incoming video using color bars.

Selecting and viewing the scopes

There are different ways you can select and view the various Matrox scopes. When you click the **Scopes** button, the **Image View** and **Scope View** tabs are available:

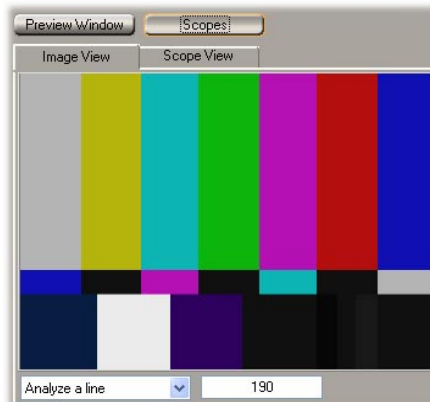

- **Image View** Lets you select the area of your clip that you want to analyze:
 - **Analyze a line** Drag the line in the **Image View** window to the line you want to analyze, or enter a line number in the text box.



Note You can select only the even lines in your clip.

- **Analyze a rectangle** Click and drag in the **Image View** window to select a rectangular area that you want to analyze. The text box displays the coordinates of your rectangle.
- **Analyze image** This selection allows you to analyze your complete image.
- **Scope View** Displays the Matrox scopes. You can change the settings to select which scopes you want to see, and how you want them to appear by clicking the ▼ button on the right side of the **Scope View** page:

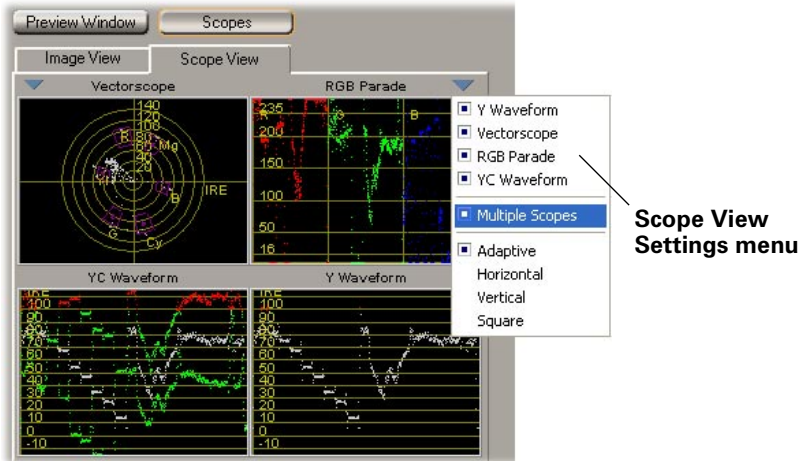

As you move your mouse within each monitor (vectorscope or waveform), you'll see a crosshair at your chosen position, and the values at that position are shown in the top right corner of the monitor.



Tip Double-click or drag the **Scope View** tab to display the Matrox scopes in a separate window that you can move and resize. This also allows you to keep **Image View** open at the same time.

Scope definitions

There are four different monitors to help you analyze your video clips:

- **Vectorscope** Shows the phase and amplitude of the color components of your video signal. Standard “targets” (small boxes) on the vectorscope correspond to the six colors in a standard color bar pattern (red, green, blue, yellow, cyan, and magenta). Color bars are usually analyzed with the

vectorscope. By analyzing color bars from your source video on the vectorscope, you can make adjustments as needed to calibrate your video. For details on how to calibrate your video, see the next section, “[Calibrating your incoming video using color bars.](#)”

- **YC Waveform** Shows a representation of the combined luminance (Y) and chrominance (C) of your video.
- **Y Waveform** Shows only the luminance (Y) values of your video, with the chrominance removed (as if your clip was in black and white).
- **RGB Parade** Shows the red, green, and blue components of your video in three side-by-side columns.

Calibrating your incoming video using color bars

Video professionals use color bars on their tapes to ensure that video clips are calibrated for correct color and brightness. Adjustments can be made based on the results of analyzing the color bars from your source video on the vectorscope and Y waveform.

- 1 From the **Matrox Proc Amp Settings** dialog box, click the **Scopes** button.
- 2 Play the section of your tape containing color bars.
- 3 On the **Image View** page, select **Analyze a line**. Select a line in your color bar pattern that includes only the colored bars representing red, green, blue, magenta, cyan, and yellow.
- 4 Double-click the **Scope View** tab to display the Matrox scopes in a separate window. From the **Scope View Settings** menu, choose **Vectorscope**.
- 5 Choose the appropriate color bar pattern from the **Vectorscope Settings** menu (click the  button on the left side of the vectorscope):

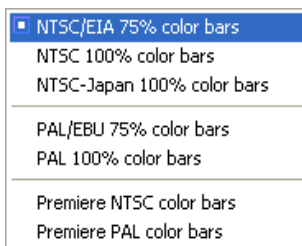

 **Important** Make sure you choose the type of color bars that matches the color bars you’re analyzing from your source video.

- 6 Check if the dots representing the colors in your color bar pattern appear within their respective targets on the vectorscope display. These targets are where the dots should appear if the color is correctly calibrated (that is, the saturation and phase relationships are correct). If needed, you can adjust the proc amp controls to get the dots as close as possible to the target boxes. Use the **Hue** control to rotate the dots around the circular graph, and use the

Saturation control to move the dots closer to or farther from the center of the graph.



Dot aligned in blue target

- 7 You can also check the white levels in your color bar pattern. From the **Scope View Settings** menu, choose **Y Waveform**. The gray or white color bar corresponds to a line on the waveform (usually the first line at the left). The IRE or mV level of this line should match the type of color bars you are using. If needed, use the **Brightness** and **Contrast** proc amp controls so that the proper IRE or mV level is set. For example, when using **NTSC/EIA 75% color bars**, adjust the **Brightness** control so that the level of IRE for the gray portion of your color bars is set to 75.
- 8 Click **OK** to save your proc amp changes and return to the **Project Settings** dialog box.

Running the Audio Capture Drift Detection test

The first time you perform an **analog** capture in Adobe Premiere, you'll be prompted to run the Audio Capture Drift Detection test. This test ensures proper audio and video synchronization between your sound card and your Matrox RT.X100 Xtreme hardware during analog captures. Click **Start** to run the test (it will take about five minutes to complete). Once the test is finished, your capture window will open.



Important If you choose not to run the Audio Capture Drift Detection test and click **Cancel**, you won't be able to perform analog captures in Premiere until you run the test.

Once you've completed the test, you won't be prompted to run the test again unless:

- You've changed your sound card.
- You have more than one sound card installed in your computer and have selected a different sound card as your preferred device for sound recording (capture). For details on how to change your preferred device for sound recording, see your Windows documentation.

There are, however, several instances in which you'll want to manually start the test again:

- You've replaced your sound card with a **similar** model. (If you replace your sound card with a **different** model, the Matrox realtime plug-in will automatically prompt you to run the test again.)
- You've updated or re-installed the drivers for your sound card.
- You've moved your sound card to another slot in your computer.

⇒ **To run the Audio Capture Drift Detection test manually:**

- 1 Choose **Start > Programs > Matrox X.tools > Audio Capture Drift Detection**.

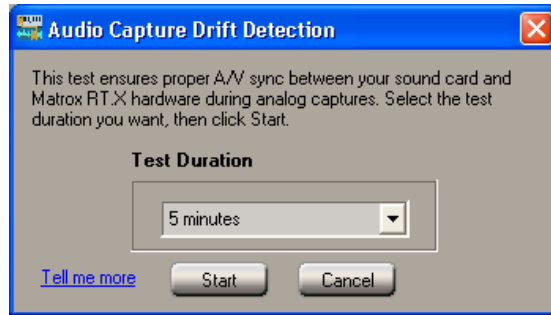

- 2 From the **Test Duration** list, select a duration for the test. In most cases, five minutes will give you good results.



Note If you often perform long analog captures (longer than one hour), it's recommended that you select one of the longer test durations, such as 10 minutes.

- 3 Click **Start** to run the test.

Performing a Premiere export to disk

Adobe Premiere lets you export video from the Timeline to a single DV/DVCAM .avi file for purposes such as distribution on CD-ROM and publishing on the web. Several software codecs are included with Adobe Premiere so that you can export your video to different formats. Your Matrox RT.X100 Xtreme system adds the Matrox DV/DVCAM codec to the ones included with Premiere. Because the Matrox codec uses your RT.X100 Xtreme hardware to accelerate rendering, it can export video much faster than when you use a software codec.



Note The Matrox MediaExport plug-in for Adobe Premiere lets you export your project to various web-optimized and MPEG formats (see [Chapter 9, “Using Matrox MediaExport”](#)). The Matrox Realtime Export to Disk feature lets you export your project to a Matrox DV/DVCAM .avi file, or an MPEG-2 Elementary (.m2v) file (see [“Performing a Matrox realtime export to disk”](#) on page 65).



To export your Timeline to a Matrox DV/DVCAM .avi file:

- 1 Depending on whether you want to export your Timeline or only the current frame from your Timeline, do one of the following:
 - To export all or part of your Timeline, choose **File > Export Timeline > Movie**. Click the **Settings** button, and from the **File Type** list, select **Matrox RT.X**.
 - To export only the current frame from your Timeline, choose **File > Export Timeline > Frame**. Click the **Settings** button, and from the **File Type** list, select **Matrox RT.X Single-frame AVI**.
- 2 From the menu at the top of the dialog box, select **Video**.
- 3 From the **Pixel Aspect Ratio** list, select the setting that matches the aspect ratio of the material you’re editing:
 - **D1/DV NTSC (0.9)** For NTSC material that uses the standard TV screen format.
 - **D1/DV NTSC Widescreen 16:9 (1.2)** For NTSC material that uses the widescreen 16:9 format.
 - **D1/DV PAL (1.067)** For PAL material that uses the standard TV screen format.
 - **D1/DV PAL Widescreen 16:9 (1.422)** For PAL material that uses the widescreen 16:9 format.
- 4 If you’re exporting all or part of your Timeline, it’s recommended that you do **not** select **Recompress**. This retains the quality of your video. It also optimizes the speed of the export because realtime segments that have no effects will be copied directly to disk without recompression.
- 5 Click **OK** to save your export settings.

Performing a Matrox realtime export to disk

On Matrox RT.X100 Xtreme, you can use the Matrox Realtime Export to Disk feature to export your Timeline in real time to either a DV/DVCAM *.avi* file, or an MPEG-2 Elementary (*.m2v*) file. You can use your *.m2v* files with DVD authoring programs, such as Sonic ReelDVD Studio and DVDIt! SE. In order to perform a Matrox realtime export to disk, you'll need a second dedicated export drive (see “[Dedicated Audio/Video \(A/V\) and export drives](#)” on page 9).

Your realtime effects and other realtime segments will be rendered in real time. Non-realtime effects, however, will not be rendered in real time and must be rendered before performing the export to disk.

If you want to export to a DV/DVCAM *.avi* file and your Timeline contains mostly cuts, you should use Adobe Premiere's Export Movie feature. This is because realtime segments that have no effects will be copied directly to disk without recompression (that is, faster than realtime), assuming that you do **not** select **Recompress**, as explained on [page 64](#).



Important On most systems, you'll be able to perform a realtime export to disk. Some systems, however, may have problems with realtime export, such as gray blocks or system sluggishness. For up-to-date information about recommended computer systems and motherboards, please see the RT.X Customer Support section of our web site at www.matrox.com/videoweb/support.



To export your Timeline to disk in real time:

- 1 Create a preview of your Timeline by choosing **Timeline > Preview**, or by pressing **ENTER**.
- 2 Choose **File > Export Timeline > Matrox Realtime Export to Disk**.



- 3 From the **Range** list, select **Work Area** to export a selected area of the Timeline, or select **Entire Timeline** to export your entire Timeline.

- 4 From the **Format** list, select **DV/DVCAM (.avi)** to export to a DV/DVCAM *.avi* file, or **MPEG-2 IBP (.m2v)** to export to an MPEG-2 Elementary (*.m2v*) file.



Note If you choose to export to an *.m2v* file, click the **Configure** button to select your MPEG-2 IBP settings as described in “[Selecting your MPEG-2 IBP settings](#)” on page 67.

- 5 From the **Audio** list, select one of the following:
 - **Uncompressed (.wav)** Audio is exported to a separate *.wav* file. Available only if you’re exporting video to an *.m2v* file.
 - **Uncompressed (embedded in .avi)** Audio is exported with your video to the same file. Available only if you’re exporting video to an *.avi* file.
 - **No audio** Only video is exported.
- 6 Beside **File Name**, click **Browse**, then specify a drive, folder, and file name for the file(s) you’re exporting. To avoid having dropped frames in your exported video, you must export to an A/V drive that’s different from the one you use to store your project’s clips.
- 7 Click **OK** to begin the realtime export to disk.

Selecting your MPEG-2 IBP settings

When you select the MPEG-2 IBP format to capture or export video using Adobe Premiere, you can specify various settings for the MPEG-2 compression.

⇒ To select your MPEG-2 IBP settings:

- 1 Click the **Configure** button if you're performing a realtime export to disk, or click the **Format** button if you're defining capture settings. This displays the following dialog box:

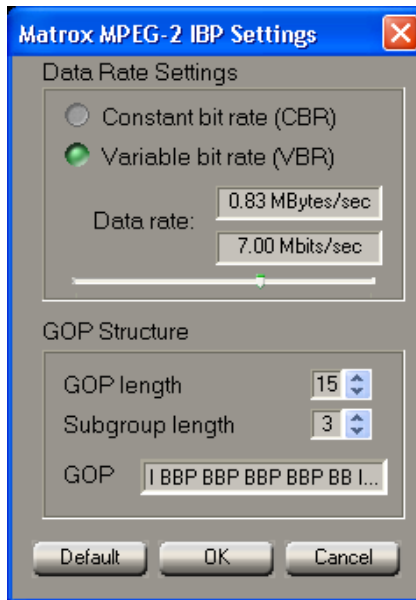

- 2 To automatically set DVD-compliant settings suitable for use with DVD authoring programs, click the **Default** button. For example, if you'll be exporting video for use with Sonic ReelDVD Studio or DVDit! SE, your material must be DVD-compliant.

i **Important** If you want to specify a custom configuration, such as by changing the bit rate type or GOP structure, make sure that your settings are supported by the program you'll be using with your *.m2v* file. Changing the GOP structure may give you undesired results. You should change these settings only if you're an advanced user.

- 3 Under **Data Rate Settings**, select one of the following bit rate types:
 - **Constant bit rate (CBR)** Video is compressed at exactly the data rate you select. This is useful when you need to limit or predict the size of your *.m2v* file. However, if your video is very complex (such as scenes with lots of movement or many colors), you'll need to select a high data rate to avoid having frames of very blocky video in your *.m2v* file.

- **Variable bit rate (VBR)** Video is compressed at varying data rates based on the complexity of the video. The data rate you select is used as the average target data rate for the compression.
- 4 Drag the **Data rate** slider until your desired data rate is displayed. You can also use the arrow keys (left, right, up, and down arrows) to select a precise value. The higher the data rate you select, the better the video quality will be.¹
-  **Important** The maximum recommended DVD-compliant data rate is 7.0 Mbits/sec (0.83 MBytes/sec), which should give you good results with most DVD authoring programs. If you select a higher data rate, be aware that it may not be supported by your authoring program. For charts of recommended data rates, see [“Recommended MPEG data rates for distribution on DVD-R or CD-R”](#) on page 267.
- 5 You can customize the GOP structure of the MPEG-2 compression as follows:
 - **GOP length** Determines the number of frames in the GOP (Group of Pictures).
 - **Subgroup length** Determines the subgroup length of B-frames and/or P-frames in the GOP, after the initial I-frame. A subgroup of 3 appears as “BBP,” a subgroup of 2 appears as “BP,” and a subgroup of 1 gives you only P-frames after the initial I-frame.
 - 6 Click **OK** to save your settings.

¹ When selecting the data rate for a Matrox codec, be aware that a megabit (Mb) is equal to 1,000,000 (1000 × 1000) bits, and a megabyte (MB) after binary conversion is equal to 1,048,576 (1024 × 1024) bytes.

Setting up DV-1394 device control

With Matrox RT.X100 Xtreme, you can take advantage of the DV-1394 device control on your DV camera or deck when capturing or recording material in Adobe Premiere.

Important To be able to perform a frame-accurate export to tape, you must use Matrox DV-1394 device control.

⇒ **To set up this device control:**

- 1 Choose **Edit > Preferences > Scratch Disks and Device Control**.
- 2 Under **Device Control**, select **Matrox DV-1394 Device Control**.
- 3 Click **Options** to display the following dialog box:

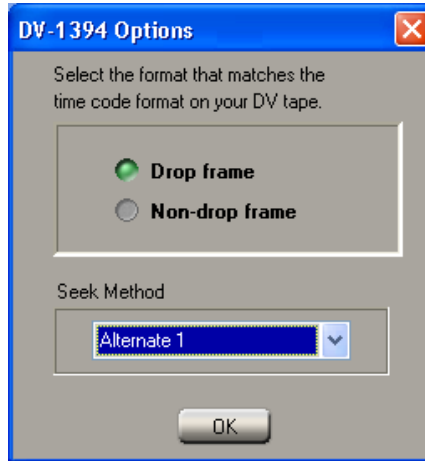

- 4 If you have an NTSC system, select the format that matches the time code format on your DV tapes (**Drop frame** or **Non-drop frame**).
- 5 Under **Seek Method**, if you're having trouble controlling your DV-1394 device, select an alternate method to improve its performance. For example, if your DV-1394 device stops responding after performing a batch capture or cues incorrectly to an In/Out point on tape, you can experiment with alternate seek methods until you find the one that works best with your DV-1394 device.



Note Most devices work best with the default seek method. If, however, an alternate seek method improves the performance of an RT.X-compatible DV-1394 device, this will be mentioned in the RT.X Support section of our web site.

- 6 Click **OK** to return to the **Preferences** dialog box, then click **OK** to save your settings.

You can now use device control when capturing or recording material using your DV-1394 device (make sure your device is set to Remote or VTR Mode). Device control will be available when capturing or recording material over the 1394 interface, and also when capturing the analog input from your DV-1394 device, such as the composite input.

For details on how to capture material in Adobe Premiere, see your *Adobe Premiere User Guide*. To record your Adobe Premiere Timeline onto DV tape using device control, see [“Exporting your Timeline to DV tape”](#) on page 71.



Note When capturing material using DV-1394 device control, the **Preroll Time** and **Timecode Offset** features are not supported. If you want to capture material from a composite or S-Video deck, make sure you select **None** under **Device Control**.

Exporting your Timeline to DV tape

You can export DV material from your Adobe Premiere Timeline to tape using device control over the 1394 interface on Matrox RT.X100 Xtreme.



Note On most systems, you'll be able to perform a realtime export to tape. Some systems, however, may have problems with the realtime export, such as gray blocks or system sluggishness. If this happens, disable the realtime export by clearing **Enable realtime export to tape** in the **Matrox Advanced Settings** dialog box as explained in “[Selecting your DV-1394 settings](#)” on page 50.

Preparing your tapes for recording

To use DV-1394 device control, the tape on which you'll be recording your DV material must contain continuous and consecutive time code. You can stripe your entire tape with time code by recording black video for the duration of the tape. To do this, insert a blank tape into your camcorder, put the lens cap on, then record up to the end of the tape.



Note The format of your DV tape must match the format you're recording. For example, if you set your DV-1394 device to record in DV/DVCAM format, your tape must be striped entirely in DV/DVCAM format. Mixed format tapes are not supported.

Obtaining a frame-accurate export to tape

In order to achieve a frame-accurate export to tape, you need to specify various export options. The values you enter for these options depend on the DV-1394 device you are using. Preset values are available for some devices. You can download the latest DV-1394 device presets from the RT.X Support section of our web site at www.matrox.com/videoweb/support. If no presets are available for the device you are using, you will need to do a test export to obtain the correct values. For more information, see “[Defining your export to tape options](#)” on page 74.

Exporting to DV tape with device control

To export your Timeline to tape over the 1394 interface:

- 1 Make sure your DV device is properly connected, turned on, and that you've selected **Matrox DV-1394 Device Control** in Adobe Premiere's **Preferences** dialog box as explained in “[Setting up DV-1394 device control](#)” on page 69.



Note If you're using a camcorder, switch it to VTR Mode.

- 2 Load a tape that you've striped with time code into your device.
- 3 Open the project you want to export to tape.

- 4 Choose **File > Export Timeline > Export to Tape**. This displays the following dialog box:

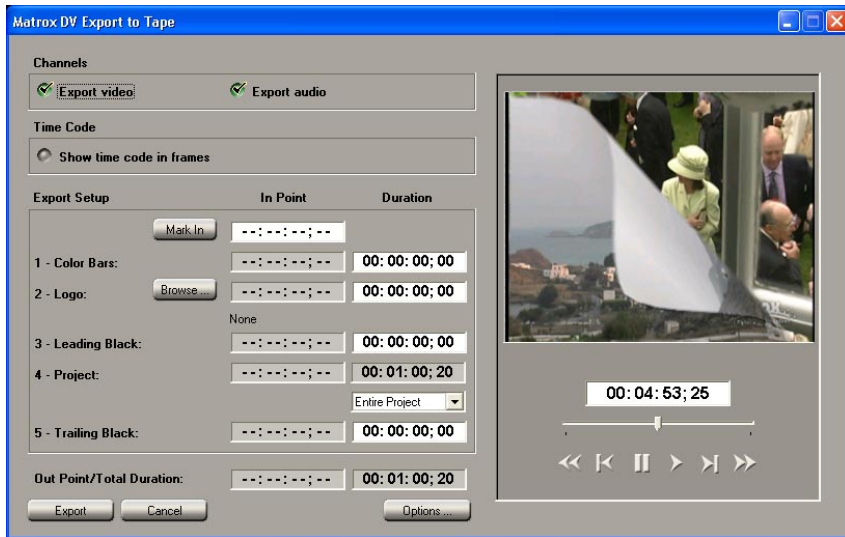

- 5 Indicate which **Channels** you want to export by selecting **Export video** and/or **Export audio**. If you decide to export audio only, black video will accompany your audio.
- 6 By default, the edit points are displayed in time code format. If you would like to display the edit points in frames, select **Show time code in frames**.
- Tip** To toggle between the two formats, press **CTRL+SHIFT** while the insertion point (flashing vertical bar) is in a time code field.
- 7 To mark the In point where you want to start recording on your tape, play your tape using the transport controls provided in the dialog box, then click the **Mark In** button when you see the frame you want. You can also type the In point you want in the **Mark In** field.
- 8 Under **Export Setup**, specify how you want the export to be done, such as whether you want to record color bars at the start of your tape, and record your entire project or just the work area.



Note You can enter values in the **Duration** fields only. The **In Point** fields are automatically adjusted for you based on the values you enter in the **Duration** fields. Items are recorded on your tape in the order they are listed in the dialog box.

– **Color Bars** To add color bars at the start of your recording, enter a duration for the amount of time you want the color bars to be recorded.



Note Color bars are accompanied by a 1-kHz audio tone.

- **Logo** To add a logo to your recording, click the **Browse** button to locate the logo you would like to add, then enter the duration for the logo. The logo must be a full-screen, 32-bit, uncompressed *.tga* file.
 - **Leading Black** To add black video to the start of your project, enter a corresponding duration.
- 9 From the **Project** list, select **Entire Project** to export your entire project, or **Work Area** to export the range marked by the work area bar.
 - 10 To add black video to the end of your project, enter a value in the **Duration** field for **Trailing Black**.
 - 11 Click **Export** to start the export to tape.



Note Non-realtime segments will be rendered by Adobe Premiere before the export.

Defining your export to tape options

In order to achieve a frame-accurate export to tape, you need to specify various export options. The values you enter for these options depend on the DV-1394 device you are using.



Note Not all DV-1394 devices are frame-accurate. For more information, please see the RT.X Support section of our web site at www.matrox.com/videoweb/support.



To define your export options:

- 1 Choose **File > Export Timeline > Export to Tape**, then click the **Options** button.

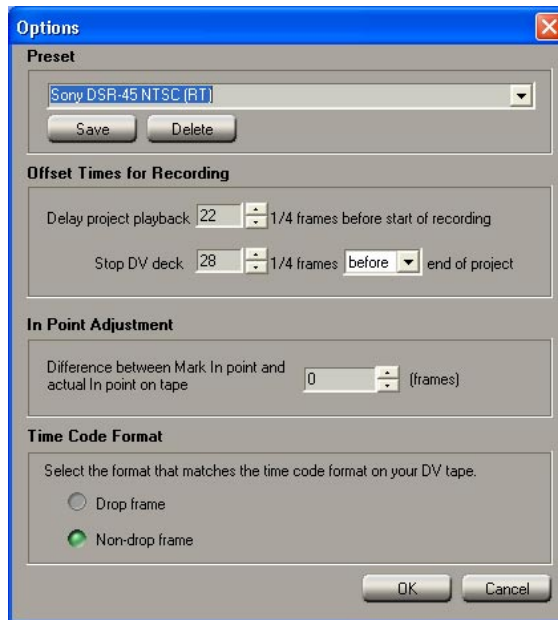

- 2 From the **Preset** list, select the model that matches (or most closely matches) the DV-1394 device you are using. This will immediately apply the appropriate export options for that device.

Remarks

- If you're performing a realtime export to tape, make sure you select an **RT** preset, such as **Sony DSR-45 NTSC (RT)**. If you disabled the realtime export (that is, you cleared **Enable realtime export to tape** in the **Matrox Advanced Settings** dialog box as explained in “[Selecting your DV-1394 settings](#)” on page 50), you must select a **Non-RT** preset.
- You can download the latest DV-1394 device presets from the RT.X Support section of our web site at www.matrox.com/videoweb/support. If a preset is not available for your DV-1394 device, you will need to do a test export

to obtain the correct values. Once you've got the right values, type the name of your device in the **Preset** box and click the **Save** button. Your settings will be saved in the **Preset** list for future use.

- 3 Under **Offset Times for Recording**, specify the appropriate values for your DV-1394 device.
 - The first value delays the playback of your project to allow your DV-1394 device time to start recording. For example, some devices require a delay between the time they receive the record command and the time the project starts playing back from your computer.
 - The second value lets you specify when the command to stop recording should be sent to your DV-1394 device. For example, if your DV deck takes time to stop recording, the stop command must be sent before the end of the project is reached. Alternately, if your deck buffers video prior to recording, the stop command must be sent late.



Important The values under **Offset Times for Recording** are interdependent. Before changing these settings, you should first do a test export to tape with both values set to zero. If you're missing frames from the start of your project, specify a delay for the project playback and do another test. Once you've set the correct delay to obtain frame accuracy at the start of the recording, you can adjust the other setting as needed to obtain frame accuracy at the end of the recording.

- 4 If the In point at which the recording starts on your tape doesn't match the **Mark In** point you specified for the export, use the value under **In Point Adjustment** to correct it. For example, if you set your **Mark In** point to 1:00:20:10 and your deck actually started recording at 1:00:20:12, then you would enter -2.
- 5 If you have an NTSC system, select the format that matches the time code format on your DV tape.
- 6 Click **OK** to save your settings and return to the **Matrox DV Export to Tape** dialog box.

Things you need to know about using DV-1394 devices

Please keep the following points in mind when using a DV-1394 device with Matrox RT.X100 Xtreme to capture or record DV material in Adobe Premiere:

- Set your camcorder to either Camera Mode (to capture live video), or VTR Mode (to capture from tape or record material onto DV tape).



- Tip** When in Camera Mode, make sure that the cassette compartment is empty to avoid possible auto-shutdown of the camera.
- Captured DV audio is sampled at a rate of 48 kHz, 16-bits/sample. Any audio recorded at a lower sampling rate or bit depth will be resampled to these values. For the best results, it's recommended that both your camcorder and DV deck be able to support 16-bit, 48 kHz audio.
 - To use DV-1394 device control, your DV tapes must contain continuous and consecutive time code, and all material on the tape must be recorded at the same speed. Leaving blank gaps between recorded material results in discontinuous time code. To avoid this problem, stripe your entire tape with time code before recording your source material (see [“Preparing your tapes for recording”](#) on page 71). The existing time code will be used when you shoot your footage and any gaps between sections of recorded material will have continuous time code.
 - When performing an export to tape, the format you are recording must match the format on your DV tape. For example, if you set your DV-1394 device to record in DV/DVCAM format, your tape must be striped entirely in DV/DVCAM format. Mixed format tapes are not supported.
 - The DV-1394 device control requires about six seconds of preroll before capturing material. Therefore, don't record material that you want to capture within the first six seconds of your DV tape.
 - When using DV-1394 device control, the running time code display in Adobe Premiere may temporarily stop. This has no effect on your captured clips. When the display resumes, the correct time code will be displayed.
 - When performing a batch capture, you'll see video in the preview window while the clips are being captured, but not while Adobe Premiere searches for each clip's In point. If you've connected the analog output from your DV-1394 device to an NTSC or PAL video monitor, you'll see the video being played on your video monitor. You may want to use the toggle switches on your video monitor to switch between viewing the output from your DV-1394 device and the output from the RT.X100 Xtreme breakout cable.

Creating a production in 16:9 format

When editing on Matrox RT.X100 Xtreme, you can choose to work with source video that's been recorded in either the 4:3 standard TV screen format, or the widescreen 16:9 format.

⇒ **To create a production in 16:9 format on Matrox RT.X100 Xtreme, do the following:**

- 1 Record your video onto tape with your camera set to the widescreen 16:9 format. The video will be recorded as horizontally compressed 4:3 video.
- 2 Start Adobe Premiere, then set your editing aspect ratio to **16:9** as explained in the section “[Selecting your editing aspect ratio](#)” on page 46. This ensures that the effects you create on Matrox RT.X100 Xtreme will be displayed with the correct proportions when viewed in 16:9 format.



Note When editing in 16:9 format, certain pre-created Matrox organic wipe or mask patterns may appear distorted. For example, circular wipes will appear elongated.

- 3 Capture your video clips as you normally would. Select the 16:9 display option on your NTSC or PAL video monitor to “unsquish” the video and play it back in widescreen format without distortion.
- 4 If you create animations, titles, or graphics (including organic wipe or mask patterns) for your production using a program that lets you set the pixel aspect ratio, use the appropriate setting for 16:9 display:
 - On an NTSC system, set the pixel aspect ratio to 1.185.
 - On a PAL system, set the pixel aspect ratio to 1.422.

If you can't set the pixel aspect ratio, create your image at 853×480 (NTSC) or 1024×576 (PAL). After you've created your image, resize **only** its width to 720. When you resize the image, your text or graphic will appear elongated on your computer screen.

- 5 Edit your production as you would a standard 4:3 production. Make sure you change the pixel aspect ratio setting for your project to **D1/DV NTSC Widescreen 16:9 (1.2)** or **D1/DV PAL Widescreen 16:9 (1.422)**, as explained in the section “[Defining your Video settings](#)” on page 54.



Note Be aware that if your video monitor is displaying in 4:3 format, certain effects may appear elongated because of the horizontal scaling. Setting your monitor to 16:9 will display the effects with the correct proportions.

- 6 Record your finished production onto tape. Remember that you'll need a monitor capable of displaying material in 16:9 format to properly view your master tape.

Your notes

6

Setting Up Realtime Effects with Adobe Premiere

This chapter explains how to set up realtime effects using the Matrox realtime plug-in for Adobe Premiere.

Available effects

The Matrox realtime plug-in for Adobe Premiere lets you:

- Set up spectacular realtime 2D and 3D effects and transitions, using up to two video clips and four graphics clips. The plug-in includes chroma keys, luma keys, color corrections, 2D/3D DVEs, particles, blurs, page curls, organic wipes (including Pixélan Software’s Video SpiceRack Lite), and many more effects.
- Set up over 60 Adobe Premiere transitions in real time.
- Change various effect settings, and add or modify keyframes to customize your effects.
- Create graphics overlays using single-frame graphics files with an alpha-key channel.
- Create realtime fade (video opacity) effects using Adobe Premiere’s Opacity rubberband.
- Apply realtime speed changes to video clips.

Realtime means that you can play back and record your effects onto tape without having to render them. This gives you creative freedom to experiment with different effects and change your mind as often as you want. You’ll instantly see the changes you make on your NTSC or PAL video monitor. Effects in Adobe Premiere other than those listed above are **not** realtime, and therefore require rendering. For guidelines on setting up your realtime effects, see [“How to place your effects to avoid rendering”](#) on page 81, and [“RT.X100 Xtreme realtime rules”](#) on page 170.

When you install the Matrox realtime plug-in, the Matrox effects are added to Adobe Premiere so that you can include them in your video productions. You set up Matrox effects in your productions the same way as other effects included with Adobe Premiere. For example, you apply a Matrox transition to your clips just as you would any other type of transition, except that the dialog box provided lets you create a Matrox transition, as is explained in this chapter.

For instructions on how to apply Adobe Premiere effects to your productions, refer to your *Adobe Premiere User Guide*. For details on selecting which Adobe Premiere transitions you want to play back in real time, see [“Selecting your realtime effect settings”](#) on page 52.



Important To use the Matrox realtime plug-in, you must have defined your Adobe Premiere settings for use with your Matrox RT.X100 Xtreme, as explained in [Chapter 5, “Defining Your Adobe Premiere Settings.”](#)

How to place your effects to avoid rendering

All the Matrox effects require a certain amount of preload time that's determined by the capabilities of your system (both CPU and storage). To keep your effects realtime, use the following guidelines when setting up your effects:

- Leave a gap of at least two seconds between the end of one Matrox particle effect and the start of the next.

Two-second gap between particle effects

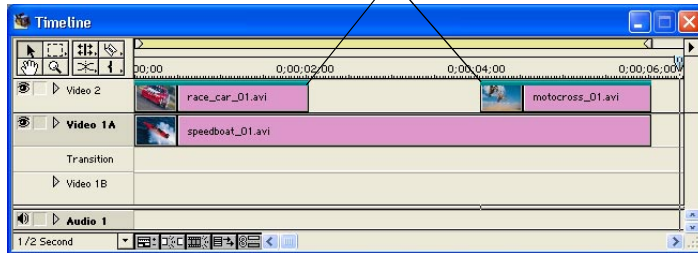

Note The Matrox distortion effect (available as an add-on from your RT.X installation CD) requires a gap of at least one second between the end of one distortion effect and the beginning of the next.

- Arrange all other Matrox effects, cuts, and single-frame graphics on your Timeline with a minimum duration of one second between the starting point of each clip.

One second between the starting point of each clip

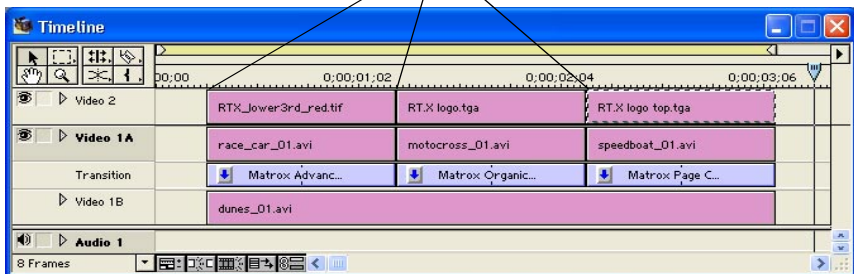

- When playing the Timeline, a maximum of four single-frame graphics clips can be stored in the Matrox RT.X100 Xtreme buffer. Because each clip requires one second to clear the buffer before the next graphics clip on the Timeline can be preloaded, you'll need to leave an appropriate gap between your graphics clips depending on how many graphics are loaded in the buffer for a given sequence, and how many graphics need to be pre-loaded for the next sequence.

The following sequence of graphics clips follows the proper spacing guidelines by not having more than four clips in the buffer at a time:

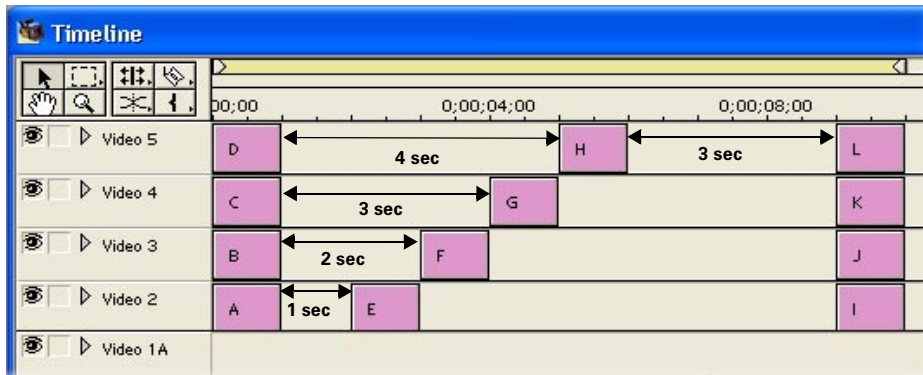

Remarks

- If any of these guidelines aren't respected and your segment requires rendering (that is, there is a red bar above the time ruler), with Xtreme Preview enabled, you'll still be able to preview your segment without rendering. For more information, see [“What is XtremePreview?”](#) on page 169.
- Because of the spacing restrictions for single-frame graphics files, graphics sequences (such as *.tga* and *.bmp* sequences) are not supported on Matrox RT.X100 Xtreme.

How to apply a Matrox transition in Adobe Premiere

In Adobe Premiere, all of the transitions can be found in the **Transitions** palette. By default, the Matrox transitions are found in the **Matrox** folder.

An easy way to create a Matrox transition is to drag the desired effect from the **Transitions** palette to the Transition track of the Timeline (between clips on the Video 1A and 1B tracks). To set up your Matrox transition, double-click the transition's icon on the Timeline. This opens the **Matrox Effect Setup** dialog box.



Note To change the default transition, see [“Specifying a default Matrox effect”](#) on page 86.

How to apply a Matrox video effect in Adobe Premiere

The Matrox realtime plug-in for Adobe Premiere allows you to apply many realtime video effects to your clips. To apply a Matrox video effect to a clip, drag the desired effect from the **Video** effect palette onto the clip on the Timeline. By default, the Matrox video effects are found in the **Matrox** folder.

To set up your Matrox video effect, click **Setup** beside your effect in the **Effect Controls** palette. This opens the **Matrox Effect Setup** dialog box.



Note To change the default video effect, see [“Specifying a default Matrox effect”](#) on page 86.

Applying Matrox video effects to graphics

If you want to apply a Matrox video effect to a graphics clip placed on a superimpose track (Video 2 or higher), you must apply an Alpha Channel key to the clip in order to see the underlying image in your effect. To do this, right-click your graphics clip on the superimpose track and choose **Video Options > Transparency**. In the **Transparency Settings** dialog box, choose **Alpha Channel** as the **Key type**.



Tip You can also select the graphics clip on the Timeline and press **CTRL+G** to open the **Transparency Settings** dialog box.

Using common controls in the plug-in

When you apply a Matrox realtime effect, a dialog box similar to the following appears (the resulting dialog box depends on the type of effect that you apply):

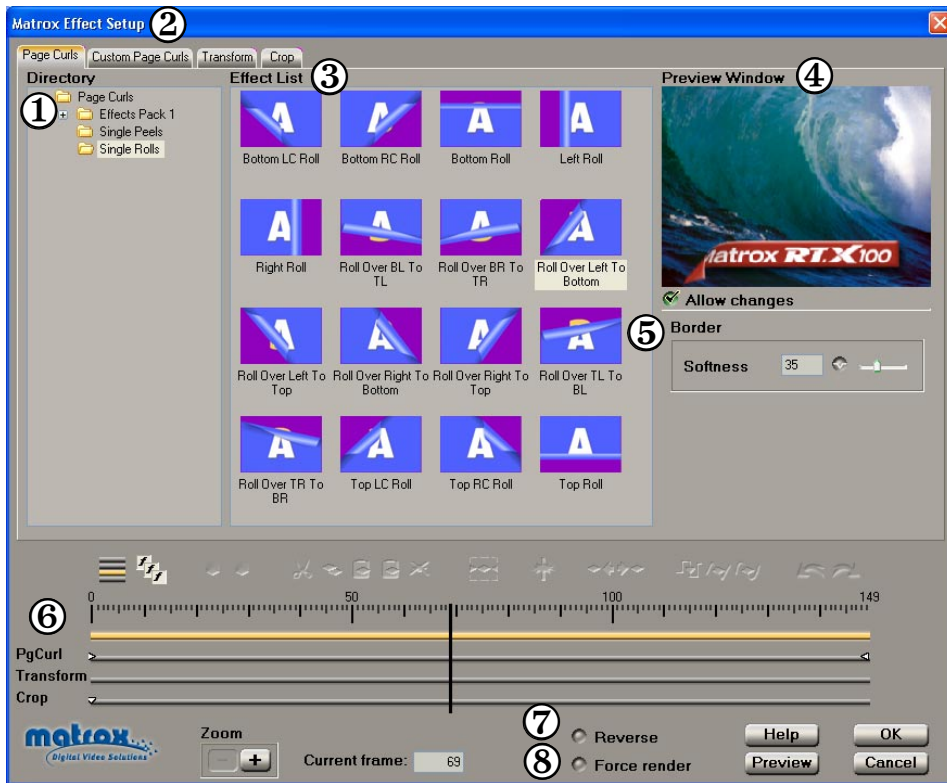

These items are common to most Matrox realtime effects:

- ① **Directory** This directory tree holds all of the effects for each transition or video effect type. If any effects have been added or deleted since the last time you selected a directory, a dialog box will appear with a summary of the changes.
- ② **Effect tabs** Several tabs are available to let you switch between pages for setting up and customizing your effect:
 - **“Pre-created effect” tab** This tab displays the default page that appears when you first apply a Matrox effect. On this page, you can select a pre-created effect from the **Directory**, for the type of effect that you’ve applied (such as any of the available page curls).
 - **Custom tab** Click this tab to display the **Custom** page, where you can customize your effect with various settings. These settings are different

depending on the type of effect you've applied. For more information, see [“Common controls on the Custom pages”](#) on page 87, and the sections for each Matrox effect in this chapter.

- **Transform tab** Click this tab to display the **Transform** page, where you can apply various settings to transform your clip, such as to resize and rotate your clip. For details on the available transform settings, see [“Transforming your clip”](#) on page 149.
- **Crop tab** Click this tab to display the **Crop** page, where you can apply crop settings to your effect, such as to remove unwanted edges. For details on using the crop settings, see [“Cropping your effect”](#) on page 153.



Note The **Transform** and **Crop** tabs are not available for all Matrox effects.

- ③ **Effect List** This section provides a small sample (icon) representing each effect. Simply click an effect to select it. If you're creating a transition, “A” and “B” represent your clips on the Video 1A and 1B tracks, respectively. If you're creating a video effect, “A” represents the clip on which you're applying the effect, and “B” represents your underlying (background) image on the lower tracks.
- ④ **Preview Window** Allows you to see the result of your chosen effect. Your effect will also be displayed on your NTSC or PAL video monitor.
- ⑤ **Effect modifiers** By selecting **Allow changes**, you can change various settings for the effect (these will differ for certain transitions and video effects). These settings are active for the duration of your clip. Not all Matrox effects have effect modifiers on the pre-created page.
- ⑥ **Keyframe controls** Several controls are provided in this section to let you move around to different points on your clip and create keyframes. For details, see [“Working with keyframes”](#) on page 157.
 - **Toolbar** Provides buttons for the most commonly used keyframe tasks. Only buttons that can be used at a given time are available.
 - **Tracks and Ruler** The tracks represent the progression of your effect over time, with the Ruler above the tracks denoting your effect's frame numbers. You can create keyframes on the tracks to change a clip's settings over time, such as to make a clip progressively shrink and expand.
 - **Positioner** You use the Positioner (vertical bar) to preview an effect by dragging it across the Ruler (scrubbing), or to specify at which frame you want to create a keyframe on the track. To move the Positioner to a particular frame, enter the frame number in the **Current frame** box, or click the frame on the Ruler. You can also right-click the Positioner or Ruler to display a pop-up menu with commands for moving the Positioner.

– **Zoom buttons** You use the + or – zoom button to zoom in or out on the tracks. You can use this feature to find a certain frame, or range of frames, within your effect.

- ⑦ **Reverse** Select this to reverse the direction of the pattern for your selected effect.
- ⑧ **Force render** Select this to force your effect to be rendered when you return to the Timeline. Certain effects, particularly particle effects, are difficult for some systems to play back in real time without dropping frames. If you find that this is happening, select **Force render**. The effect will appear with a red bar over it when you return to the Timeline, indicating that the effect requires rendering. Once rendered, the effect will play back smoothly.

Specifying a default Matrox effect

The first time you apply a Matrox transition or effect to your Timeline, a default effect is applied. This default effect is usually the first effect in the **Effect List**. You can change the default effect for each effect category (advanced DVEs, page curls, etc.).



To change the default Matrox effect:

- 1 Set up the Matrox effect on the Timeline.
- 2 In the **Matrox Effect Setup** dialog box, locate the effect you want from the **Effect List**. If needed, select a different folder under **Directory** to find the effect you want.
- 3 Right-click the effect you want as the default effect, and choose **Set as Default Effect** from the pop-up menu.



Note The name of your default effect or transition will be highlighted in orange in the **Effect List**.

The next time you apply this category of Matrox effect to your Timeline, the default effect will be applied.

Common controls on the Custom pages

While the custom settings are different for the various Matrox effects, there are some controls that are common to all the **Custom** pages:

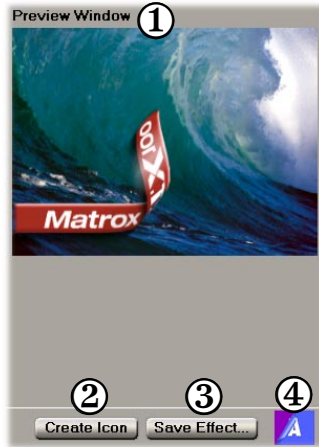

- ① **Preview Window** You can use the **Preview Window** to view the results of your changes.
- ② **Create Icon** Click this button before saving your effect to create an icon of your new effect. This icon will represent your effect in the **Effect List**, with other pre-created effects of the same type.
- ③ **Save Effect** Once you have completed your modifications to your effect (using the **Custom**, **Transform**, and **Crop** pages), you can save the new effect to your library of pre-created Matrox effects for future use. Once you click **Save Effect**, the **Save As** dialog box opens to allow you to name your effect, and save it as a *.kft* file in the folder with other similar effects. For example, when saving a custom page curl, you can save it in the *Matrox X.tools\Effects\Page Curls* folder, so that it will be available with the other pre-created effects on the **Page Curls** page.
- ④ **Icon** Once you have created an icon, you can view it here. Your icon shows a simulation of the A/B transformation of your effect.



Note After saving your effect and creating an icon, if you go back to the “pre-created effect” page, you’ll notice that your new effect is now added to the **Effect List**. To update your icons to the most current, right-click anywhere in the **Effect List**, and choose **Update All Icons**.

Previewing your effects

There are several ways to preview your effects:

- **Preview entire effect** Click the **Preview** button at the bottom of the page, or press **ALT+SPACEBAR**.
- **Preview from Positioner** Press **SPACEBAR**. To stop the preview, press **SPACEBAR** again.
- **Preview a specified range** To highlight the range you want to preview, **SHIFT+drag** on the Ruler. Click the **Preview** button to view the range you've specified. To clear the selected range, **CTRL+click** the Ruler.
- **Scrub through your effect** Drag the Positioner through the section of the effect you want to preview. You can also **ALT+drag** the Positioner to render-scrub your effect (same as when you render-scrub the Timeline).



- **Toggle track state for previewing** By default, the track state is set to preview all tracks every time you open the **Matrox Effect Setup** dialog box (that is, the effect track, **Transform** track, and **Crop** track). You can switch between previewing all tracks, one track only, or without the current effect by toggling the track state as follows:

- **Preview current track's effects** Click the **Toggle Track State** button on the toolbar once (or press **CTRL+F2**) to disable all tracks except the current track. Use any of the methods for previewing your clip. Your effect is shown with only the settings of the highlighted track applied. For example, if you want to add a colored border to your advanced DVE, but the transform and crop settings are obscuring the clip, click the **Toggle Track State** button to see the advanced DVE without the transform and crop settings.
- **Preview without current effect** Click the **Toggle Track State** button on the toolbar again (or press **CTRL+F2**) to disable all the tracks. Use any of the methods for previewing your clip. Your clip is shown without the current effect applied.



Note Click the **Toggle Track State** button again to return to the default track state (that is, previewing all tracks).



- **Preview current source only** Click the **Solo Mode** button on the toolbar (or press **F2**). Only the source for the effect that you are currently editing is previewed. All other effects on your clip and all other sources on the Timeline are ignored. If it's not possible to preview all sources in the segment you're editing, solo mode will automatically be set and the **Solo Mode** button won't be available. This would happen, for example, when a segment contains too many layers, or contains a Premiere software effect (and you didn't choose to ignore these effects as explained on [page 53](#)). To see the segment with all applied effects, use the render-scrub feature

(**ALT+drag** the Positioner). For more information on the particular cases when solo mode is automatically set, see “[What is XtremePreview?](#)” on page 169.

Tip If you have added a realtime fade to your clip using Adobe Premiere’s Video Opacity rubberband control, clicking the **Solo Mode** button allows you to temporarily remove the transparency setting without having to return to the Timeline.

Using text boxes and sliders

Text boxes and sliders are provided to let you adjust the settings for most of the Matrox effects. For example, the **Softness** text box and slider on the **Page Curls** page let you create a soft edge for your effect.

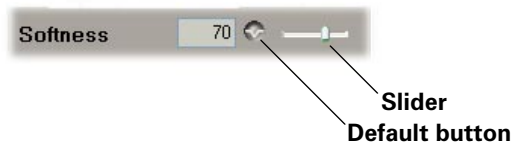

To adjust a setting, do one of the following:

- Enter the value you want directly in the text box.
- Drag up and down within the text box.
- Click inside the text box, then press the up and down arrow keys. You can also use the **PAGE UP** and **PAGE DOWN** keys to adjust the value by 10 at a time.
- Drag the slider to the left or right. For a faster but less precise adjustment, **SHIFT+drag** the slider.

Tip To return a text box and slider to its default setting, click the  button, or **CTRL+click** the slider or slider bar.

Undoing and redoing changes





You can undo and redo most changes you make to the settings of an effect in the **Matrox Effect Setup** dialog box, up to a maximum of 15 changes. To undo the last change made to the settings of an effect, click the **Undo** button on the toolbar, or press **CTRL+Z**. To redo the changes, click the **Redo** button on the toolbar, or press **CTRL+Y**.

You can continue to choose **Undo** or **Redo** to sequentially undo or redo up to 15 of your most recent changes. If a particular change can’t be undone, the **Undo** button won’t be available.

Selecting colors

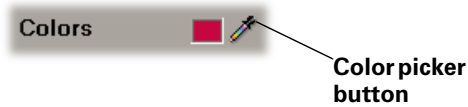
Several Matrox effects provide a “color picker” button to let you choose the color you want for the effect, such as the border color for an advanced DVE.



When you click a  button, the **Color** dialog box appears:

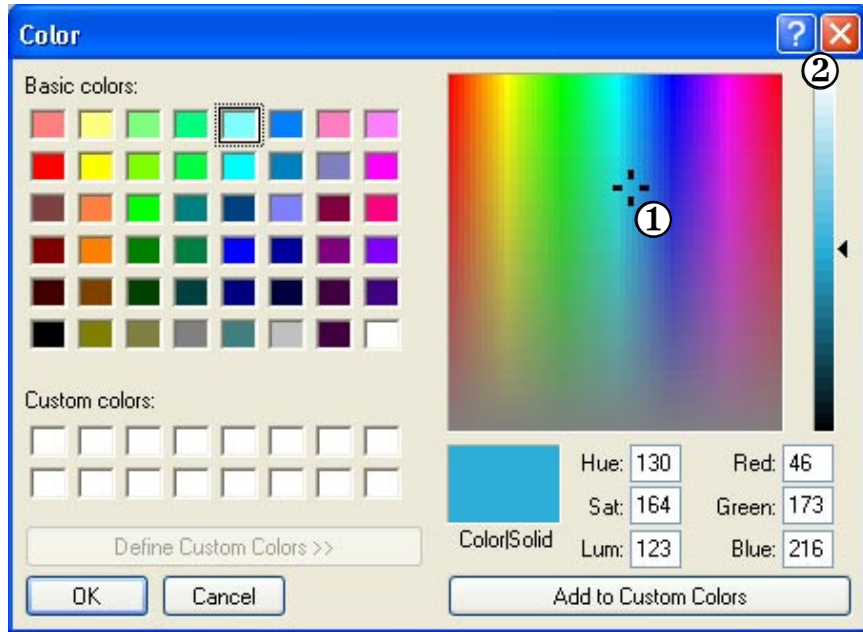

① Color refinement box

② Luminance bar



To select your color:

- 1 Click one of the basic colors on the left side of the dialog box, or click the color you want inside the Color refinement box.
- 2 Adjust your color’s luminance by clicking inside the Luminance bar or by dragging the arrow beside it.
- 3 Alternatively, if you know your desired color’s Hue, Saturation, and Luminance values, or Red, Green, and Blue values, you can enter them in the corresponding text boxes.

Applying a pre-created 3D tile

When you apply a Matrox 3D tile, the **3D Tiles** page appears:

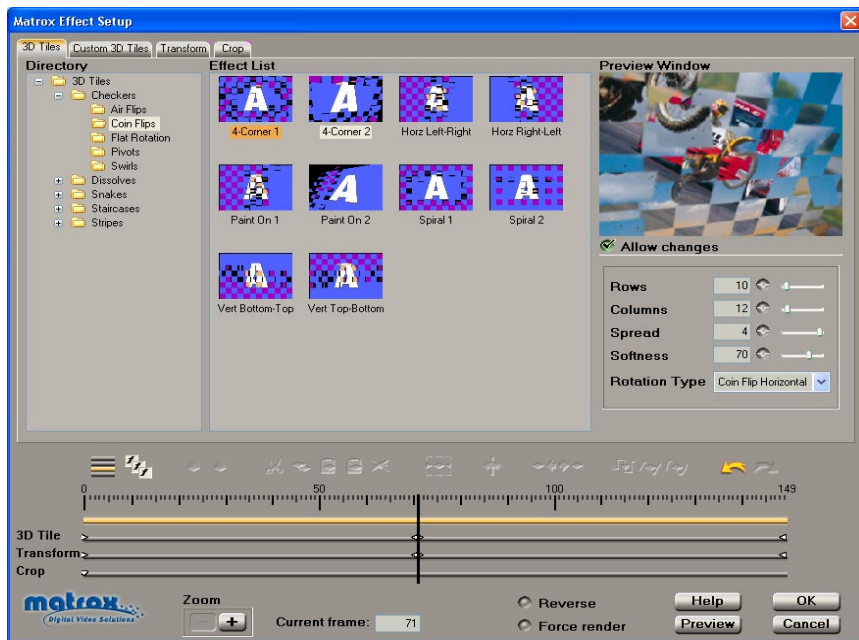

⇒ **To set up a 3D tile:**

- 1 Choose the type of effect you are looking for in the **Directory**.
- 2 Click the particular effect you want from the **Effect List**.
- 3 To see a preview of your effect at any time, click the **Preview** button.
- 4 To change the settings for your selected 3D tile pattern, select **Allow changes**, then use the 3D tile modifiers as follows:
 - **Rows** Sets the number of rows in your 3D tile pattern.
 - **Columns** Sets the number of columns in your 3D tile pattern.
 - **Spread** Determines the number of tiles that rotate at the same time.
 - **Softness** Sets the softness on the border of your clip and on the edges of the tiles.
 - **Rotation Type** Select a type from this list to change the orientation of the 3D tile pattern.
- 5 If you want to apply custom settings to your effect, see “[Creating a custom 3D tile](#)” on page 92.
- 6 If you want to apply or change various transform settings, such as to change your clip’s size, position, and rotation settings, see “[Transforming your clip](#)” on page 149.

7 When you are satisfied with your effect, click **OK** to return to your Timeline.

Creating a custom 3D tile

To customize the settings for your 3D tile, click the **Custom 3D Tiles** tab or the **3D Tile** track:

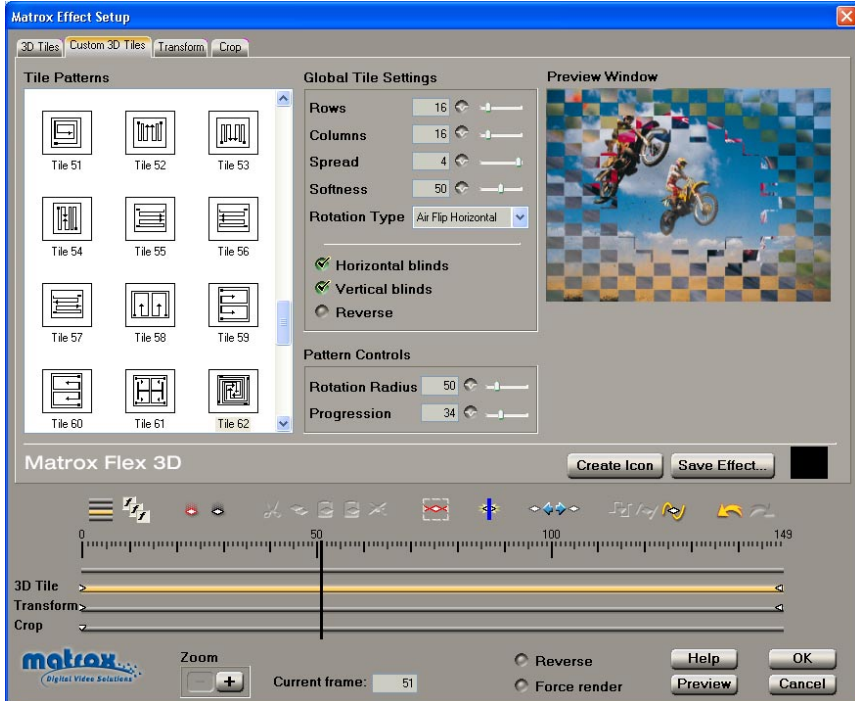

Any settings that you applied under **Allow changes** on the **3D Tiles** page are carried over to the **Custom** page. You can further customize your effect using the following:

- **Tile Patterns** Click any of these tile patterns to change the originally selected effect that you chose on the **3D Tiles** page. If you decide to change the tile pattern, you can customize it to your liking.
- **Global Tile Settings** These settings are active for the duration of your effect:
 - **Rows** Sets the number of rows in your 3D tile pattern.
 - **Columns** Sets the number of columns in your 3D tile pattern.
 - **Spread** Determines the number of tiles that rotate at the same time.
 - **Softness** Sets the softness on the border of your clip and on the edges of the tiles.

- **Rotation Type** Select a type from this list to change the trajectory of the flipping tiles.
- **Horizontal blinds** Select this to modify your pattern to use every second horizontal line.
- **Vertical blinds** Select this to modify your pattern to use every second vertical line.
- **Reverse** Select this to reverse the direction of your 3D tile pattern.
- **Pattern Controls**
 - **Rotation Radius** Sets the amount of rotation for each 3D tile in the pattern. For example, with a **Rotation Radius** of 0, your 3D tiles appear flattened, whereas with a **Rotation Radius** of 100, your 3D tiles appear more inflated.
 - **Progression** Sets the progression of your 3D tile pattern, at any frame. For example, you could set the progression to 50% at the first frame to make your 3D tile pattern start only at its mid-point.

Applying a pre-created advanced DVE

When you apply a Matrox advanced DVE, the **Advanced DVEs** page appears:

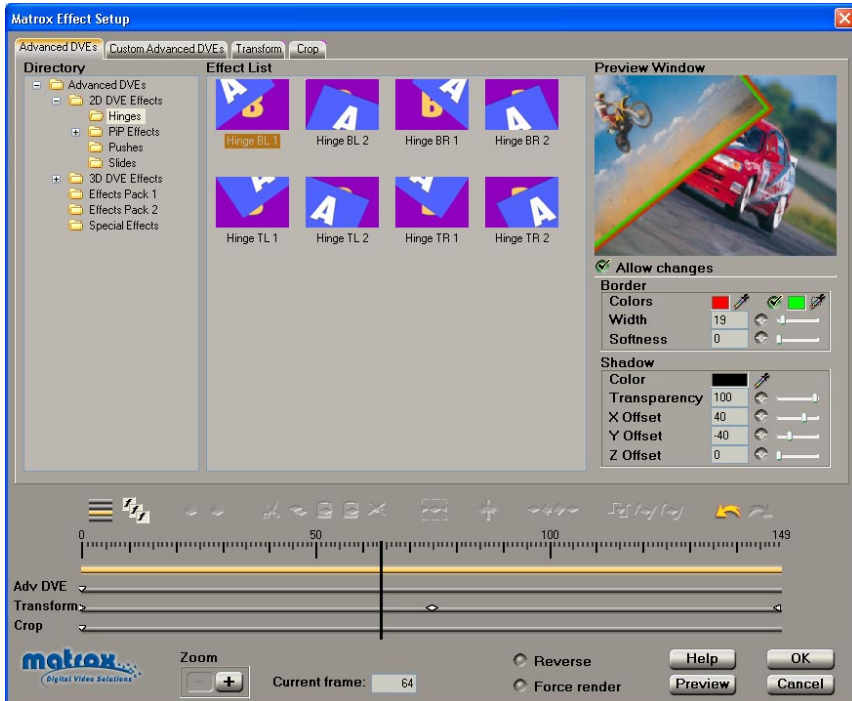



⇒ To set up an advanced DVE:

- 1 Choose the type of effect you are looking for in the **Directory**. For example, click the **PiP Effects** folder under **3D DVE Effects** to display a list of available 3D picture-in-picture effects.



Tip Static 2D or 3D DVE effects are not suitable for use as transitions. For example, the static effects listed in the 2D DVE Effects **PiP Effects** folder do not switch from one source to another. Such effects are designed to be applied as video effects only, and should not be used as transitions.

- 2 Click the particular effect you want from the **Effect List**.
- 3 To see a preview of your effect at any time, click the **Preview** button.
- 4 To create a border or soft edge on your clip, select **Allow changes**, then use the **Border** modifiers as follows:
 - **Colors** Click the first  button to select the border color you want. To create a border consisting of a gradient between two colors, select the option beside the second  button, then click that button to select your other color. For details on how to select colors, see “[Selecting colors](#)” on page 90.
 - **Width** Sets the width of the border, in pixels.



- **Softness** Lets you adjust the softness of the edge or border on your clip. The higher the softness value, the less sharp the edge or border becomes.
- 5 To display a shadow behind your clip, make sure that **Allow changes** is selected, then use the **Shadow** modifiers as follows:
 - **Color** Click the  button to select the color of your shadow.
 - **Transparency** Sets the transparency of your shadow. Levels range from opaque (0) to fully transparent (100).
 - **X Offset** Sets the position of your shadow with respect to the horizontal edges of your clip. Negative numbers move the shadow to the left, and positive numbers move the shadow to the right.
 - **Y Offset** Sets the position of your shadow with respect to the vertical edges of your clip. Negative numbers move the shadow to the bottom, and positive numbers move the shadow to the top.
 - **Z Offset** Sets the depth of your shadow behind your clip.
 - 6 If you want to apply custom settings to your effect, see [“Creating a custom advanced DVE”](#) on page 96.
 - 7 If you want to apply or change various transform settings, such as to change your clip’s size, position, and rotation settings, see [“Transforming your clip”](#) on page 149.
 - 8 When you are satisfied with your effect, click **OK** to return to your Timeline.

Creating a custom advanced DVE

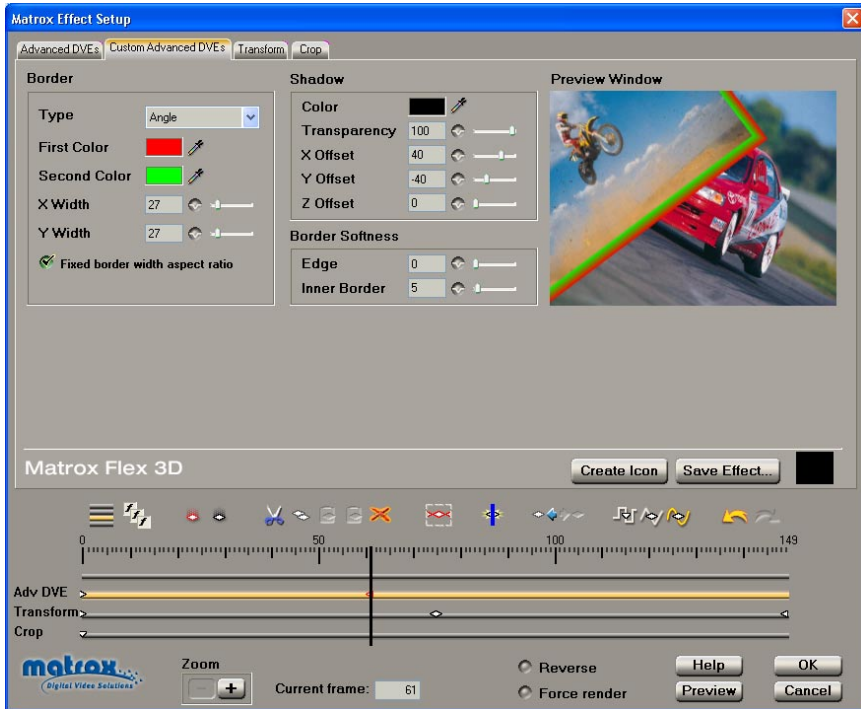
To customize the settings for your advanced DVE, click the **Custom Advanced DVEs** tab or the **Adv DVE** track:



Any settings that you applied under **Allow changes** on the **Advanced DVEs** page are carried over to the **Custom** page. You can further customize your effect using the following:

- **Border**
 - **Type** Allows you to set your border as **Flat**, **Bevel**, **Round**, or **Angle**.
 - **First Color** Click the  button to select the border color you want.
 - **Second Color** Click the  button to select your second color, used to create a border consisting of a gradient between two colors.
 - **X Width** Sets the width of the left and right edges of your border, in pixels.
 - **Y Width** Set the width of the top and bottom edges of your border, in pixels.



Tip Select **Fixed border width aspect ratio** if you want your X and Y values to be the same.

- **Shadow** These settings can also be found under **Allow changes** on the **Advanced DVEs** page:
 - **Color** Click the  button to select the color of your shadow.
 - **Transparency** Sets the transparency of your shadow. Levels range from opaque (0) to fully transparent (100).
 - **X Offset** Sets the position of your shadow with respect to the left and right edges of your clip. Negative numbers move the shadow to the left, and positive numbers move the shadow to the right.
 - **Y Offset** Sets the position of your shadow with respect to the top and bottom edges of your clip. Negative numbers move the shadow to the bottom, and positive numbers move the shadow to the top.
 - **Z Offset** Sets the depth of your shadow behind your clip.
- **Border Softness**
 - **Edge** Lets you adjust the softness of the outer edge or border on your clip.
 - **Inner Border** Lets you adjust the softness from the inside border of your clip.

Applying a pre-created basic DVE

When you apply a Matrox basic DVE, the **Basic DVEs** page appears:

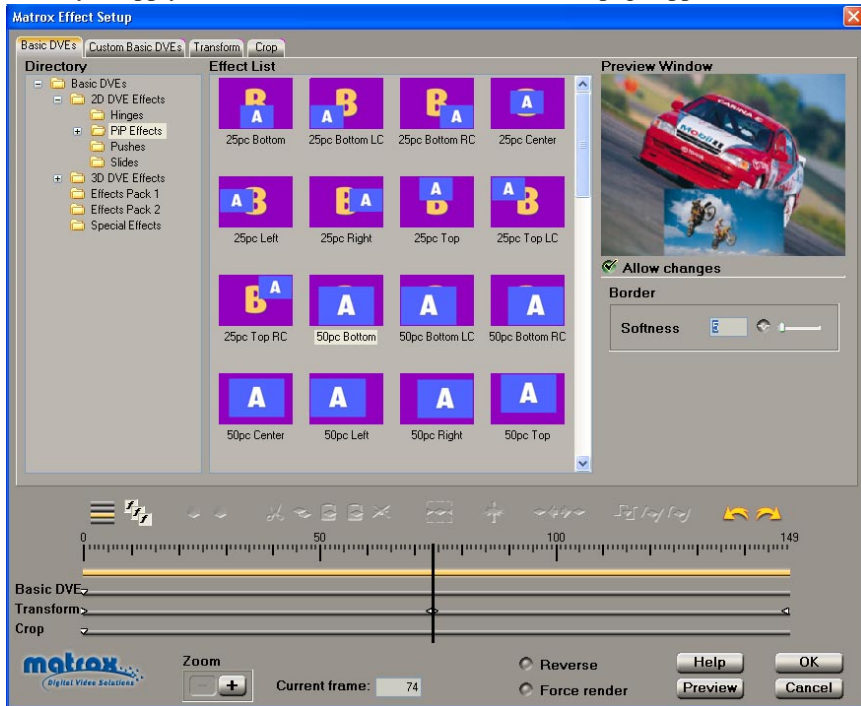

⇒ To set up a basic DVE:

- 1 Choose the type of effect you are looking for in the **Directory**. For example, click the **PiP Effects** folder under **3D DVE Effects** to display a list of available 3D picture-in-picture effects.



Note The available pre-created effects are the same as for an **Advanced DVE** (see “[Applying a pre-created advanced DVE](#)” on page 94). The basic DVEs differ in that there are fewer settings that you can change, which allows you to apply two basic DVEs on a clip in real time.

- 2 Click the particular effect you want from the **Effect List**.
- 3 To see a preview of your effect at any time, click the **Preview** button.
- 4 To create a soft edge on the border of your effect, select **Allow changes**, then drag the **Softness** slider. The higher the value, the less sharp the edge of your clip becomes.
- 5 If you want to apply custom settings to your effect, see “[Creating a custom basic DVE](#)” on page 99.

- 6 If you want to apply or change various transform settings, such as to change your clip's size, position, and rotation settings, see “[Transforming your clip](#)” on page 149.
- 7 When you are satisfied with your effect, click **OK** to return to your Timeline.

Creating a custom basic DVE

To customize the settings for your basic DVE, click the **Custom Basic DVEs** tab or the **Basic DVE** track:

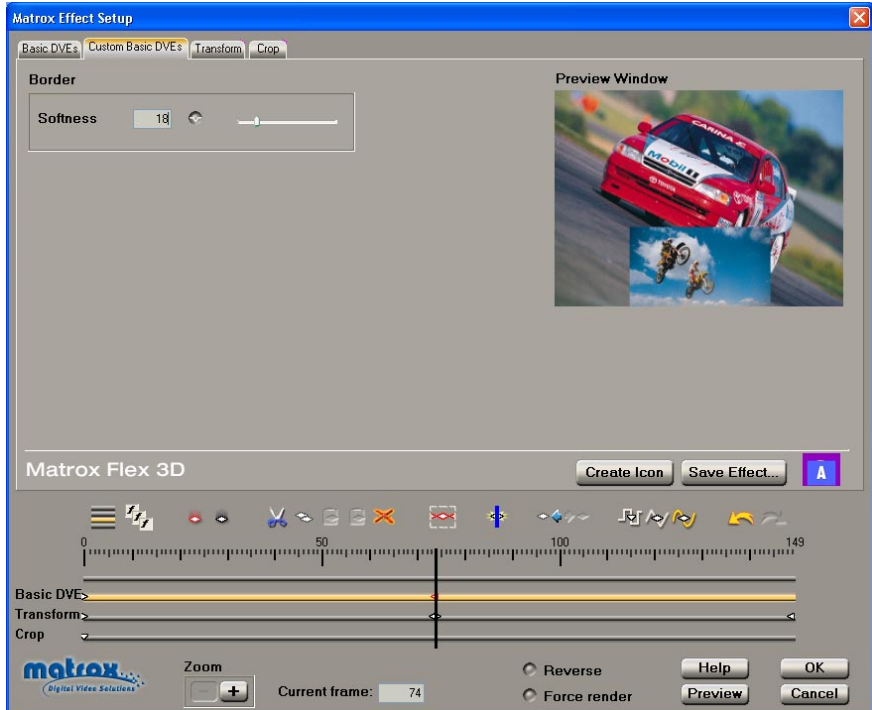

Any change you applied to the **Border Softness** on the **Basic DVEs** page is carried over to the **Custom** page. On the **Custom** page, however, you can create keyframes to change the border softness at different frames of your clip.

Applying a pre-created blur effect

When you apply a Matrox blur effect, the **Blurs** page appears:

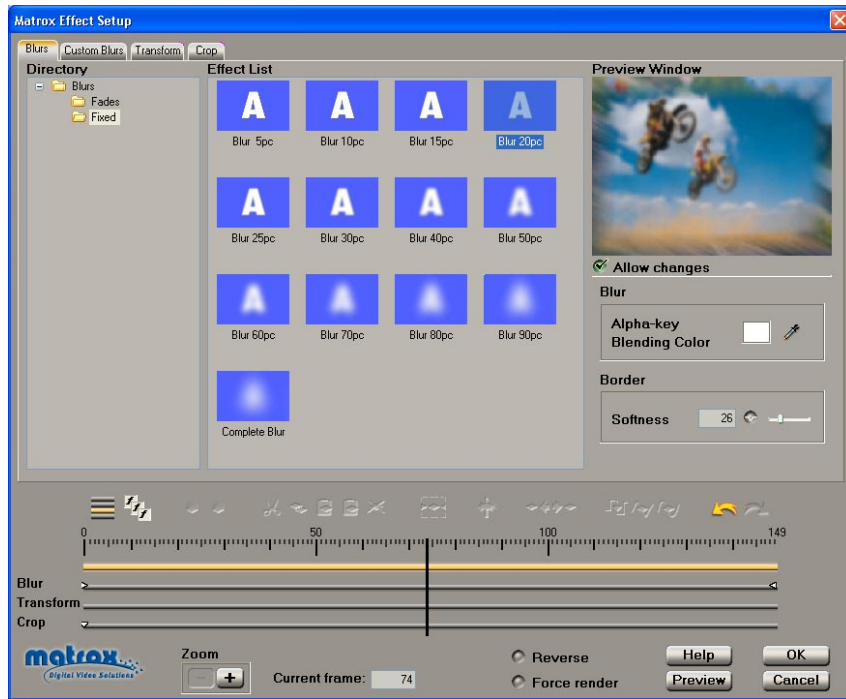

To set up a blur effect:

- 1 Choose the type of effect you are looking for in the **Directory**.
- 2 Click the particular effect you want from the **Effect List**.
- 3 To see a preview of your effect at any time, click the **Preview** button.
- 4 If your clip contains an alpha channel, you can change the alpha-key color that is used to blend your blurred clip with the underlying (background) clip. To do this, select **Allow changes**, then click the  button beside **Alpha-key Blending Color** to select the color you want.
- 5 To adjust the softness on the border of your clip, drag the **Softness** slider, or enter a value in the text box.
- 6 If you want to apply custom settings to your effect, see [“Creating a custom blur effect”](#) on page 101.
- 7 If you want to apply or change various transform settings, such as to change your clip’s size, position, and rotation settings, see [“Transforming your clip”](#) on page 149.
- 8 When you are satisfied with your effect, click **OK** to return to your Timeline.

Creating a custom blur effect

To customize the settings for your blur effect, click the **Custom Blurs** tab or the **Blur** track:

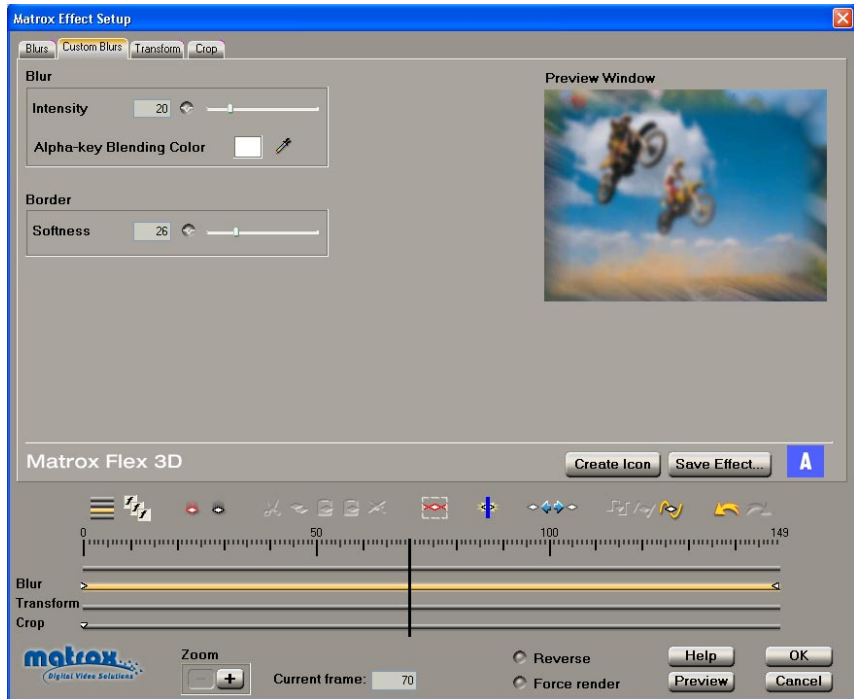

Any settings that you applied under **Allow changes** on the **Blurs** page are carried over to the **Custom** page. You can further customize your effect using the following:

- **Intensity** Use this to change the amount of blurring in your clip.
- **Alpha-key Blending Color** If your clip contains an alpha channel, you can change the alpha-key color that is used to blend your blurred clip with the underlying (background) clip. To do this, click the  button to select the color you want.
- **Border Softness** Use this to adjust the softness on the border of your clip.

Overview of the chroma key effect

You can use the Matrox realtime plug-in to apply a chroma key to make certain areas of a foreground video clip transparent based on a color in that image, so that an underlying video clip can show through.

In the following example of a chroma key effect, our foreground image is a video clip of a woman sitting in front of a green backdrop, and our underlying image is a video clip of a sand dune:

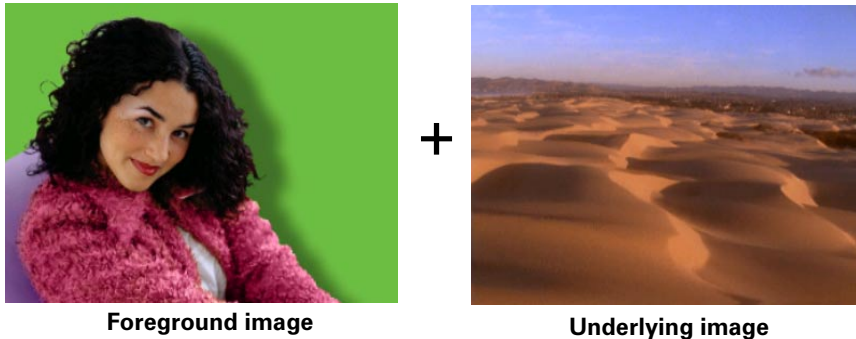

By chroma keying on the particular shade of green in the backdrop of the foreground image, the backdrop area becomes transparent and the corresponding area of the underlying image shows through in the composite image as follows:

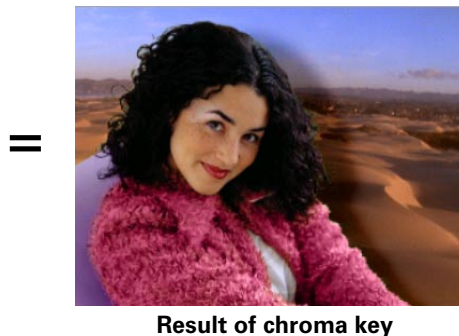

Important You must apply the Matrox chroma key effect to the clip that contains the colors on which you want to key (that is, your foreground image on a superimpose track). To create a realtime chroma key effect, both the foreground and underlying images must be video clips. If you want to use a graphics clip, you can export that clip from the Timeline to a single-frame *.avi* file, then replace the graphics clip on the Timeline with your exported file.

Creating a chroma key effect

To create a chroma key effect, select the **Dud** effect from the **Effect List** on the **Chroma Keys** page, then click the **Custom Chroma Keys** tab or the **Chroma** track:

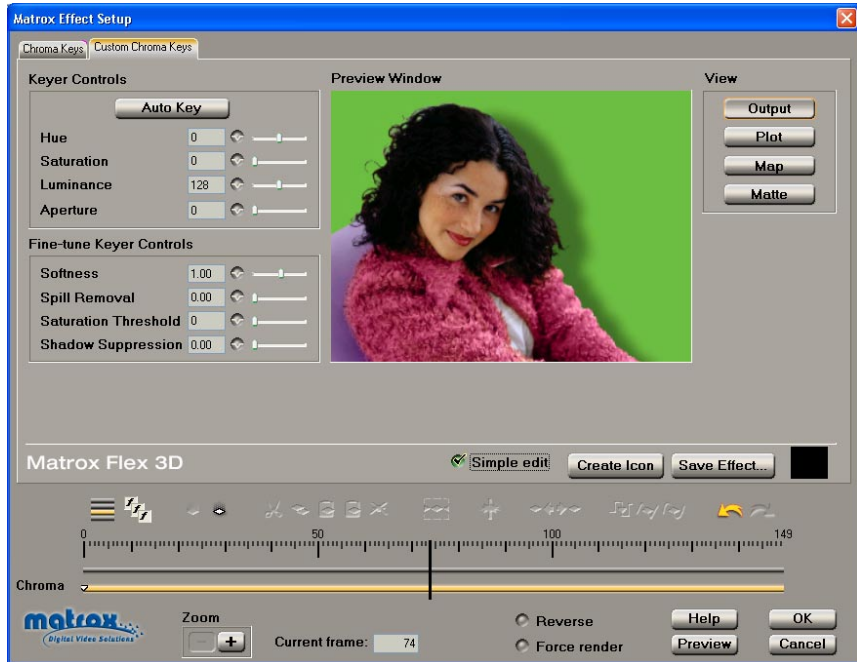

By selecting **Simple edit**, all settings are applied for the duration of your clip. This means that you'll have only one keyframe at the first frame of your clip. If you want to change settings at different frames of the clip, you'll have to clear **Simple edit**.

- **Keyer Controls**

- **Auto Key** Click this button to key on the most common color at the current frame (except gray). Selecting **Auto Key** affects values for **Hue**, **Saturation**, **Luminance**, and **Aperture**. If your clip consists of a uniform key color that is evenly lighted, **Auto Key** will usually give you a good-quality chroma key. You can also use the A keyboard shortcut to select **Auto Key**.

You can use the following controls to customize your chroma key effect:



Tip To see the color selector, you'll need to change the **View** to **Plot** or **Map**. For more information on the different views, see “[Viewing and selecting your key colors](#)” on page 105.

- **Hue** Use this to rotate the color selector around the perimeter of the color spectrum so that you can select different hues (colors) on which to key.
- **Saturation** Use this to select colors that have a particular saturation value. Pale colors have a low saturation value and are located at or near the center of the spectrum. Vivid colors have a high saturation value and are located at or near the perimeter of the spectrum. Because pale colors have low saturation, you'll find them more difficult to key on than the vivid colors.
- **Luminance** Use this to select the colors that have a particular luminance value. A luminance selector in the **Luma Plot** (Plot view) or **Luma Map** (Map view) indicates the particular luminance value you've selected.
- **Aperture** Use this to widen or narrow the aperture of the color selector to increase or decrease the range of colors on which you want to key.
- **Fine-tune Keyer Controls** Use the following controls to fine-tune your chroma key effect:

- **Softness** Use this to soften the edges of your key by blending parts of your foreground image with your underlying image. This makes certain areas of your foreground image partially transparent instead of completely transparent or opaque.
- **Spill Removal** Use this to remove the contamination (spill) that your key color may leave on or around the edges of your foreground image. Spill is usually caused by light reflecting from your solid color backdrop (key color) onto your foreground image. **Spill Removal** replaces your key color from the "spill areas" with the opposite color in the spectrum, which returns a more natural look to these areas.

For example, after applying a chroma key effect to a foreground image of a newscaster against a blue backdrop, you may find that there's a blue reflection in the newscaster's skin and hair. Increasing the **Spill Removal** level removes the blue pixels by adding yellow to these areas.

- **Saturation Threshold** Use this to proportionally increase or decrease the region outside of your saturation range. This controls how closely the **Saturation** value specified under **Keyer Controls** must match the key color before a region becomes transparent.

For example, after applying a chroma key effect to a foreground image that includes dark areas or shadows that you want to preserve in your effect, you may find that these areas have become semi-transparent. By adjusting the **Saturation Threshold**, you can eliminate the key color from these dark areas, so that they'll become completely opaque.

- **Shadow Suppression** Use this to make shadows in your clip less apparent. A higher value indicates less shadow.

Viewing and selecting your key colors

There are four ways of viewing and selecting the colors on which you want to key. To switch between the views, you can click the appropriate button, or you can use the following keyboard shortcuts: **Q** for **Output**, **W** for **Plot**, **E** for **Map**, and **R** for **Matte**.

- **Output** This is the default view when you first display the **Custom Chroma Keys** page. You can see the result of your chroma key effect in the **Preview Window**. You can click and drag in the **Preview Window** to select a rectangular area containing the colors on which you want to key. The tracking rectangle stays visible until you let go of the mouse button. The keyer controls are adjusted to reflect your selected key colors. You can also add to the previously selected key color by holding down the **CTRL** key and selecting a new rectangular area of a similar shade.



- **Plot** Click this to plot the colors and luminance values that are present in the current frame of your clip. The **Luma Plot** shows each luminance value present in your image as a vertical line in the histogram. A longer line indicates a higher amount of pixels in your image of that line's luminance value. When you adjust the keyer controls, you can see the visual representation of your changes in the **Chroma Plot** or **Luma Plot**:

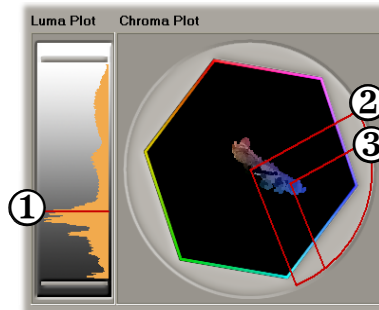

-
- ① Luminance selector ② Saturation threshold indicator ③ Color selector
-

- **Map** This view consists of a cube that contains a color spectrum, located under **Chroma Map**, and a luminance spectrum located under **Luma Map**. When you adjust the keyer controls, you can see the visual representation of your changes in the **Chroma Map** or **Luma Map**:

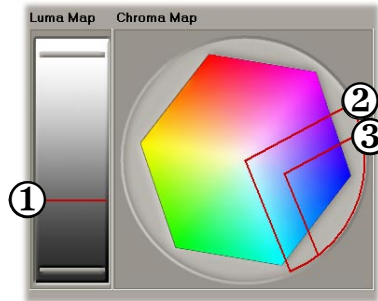

-
- ① Luminance selector ② Saturation threshold indicator ③ Color selector
-

- **Matte** This view displays the matte used to create your key effect. In the following example, you can see a white silhouette against black, with semi-transparent areas, such as soft edges, seen as grays. As explained for the **Output** view, you can use the tracking rectangle in the **Matte Window** to select an area containing the colors on which you want to key.



- Tip** You can switch to the **Matte** view to further refine your key color. For example, in **Matte** view, your key color (such as green) appears as black, and opaque areas appear as white. If you notice some white spots that you want to key, hold down the **CTRL** key as you draw the tracking rectangle over the white dots to add them to your key color. You can also adjust the keyer controls until the undesired white spots disappear.

Applying a pre-created color correction

When you apply a Matrox color correction, the **Color Corrections** page appears:

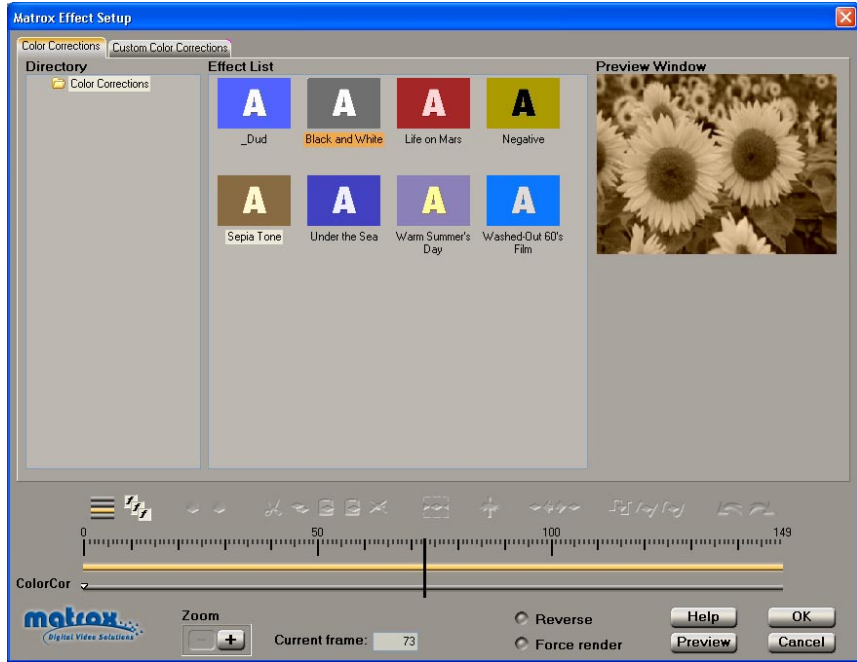

Note You can apply realtime Matrox color corrections to video clips only. If you apply Matrox color corrections to graphics clips, you'll need to render. You can, however, use an image-editing program (such as Adobe Photoshop) to correct the color of your graphics clips.



To set up a color correction effect:

- 1 Click the particular effect you want from the **Effect List**.



Tip If you want to modify your clip without using any of the pre-created settings, select the **_Dud** effect.

- 2 To change the settings for your selected color correction effect, see [“Creating a custom color correction”](#) on page 108.
- 3 To see a preview of your effect at any time, click the **Preview** button.
- 4 When you are satisfied with your effect, click **OK** to return to your Timeline.

Creating a custom color correction

To customize the settings for your Matrox color correction, click the **Custom Color Corrections** tab or the **ColorCor** track:

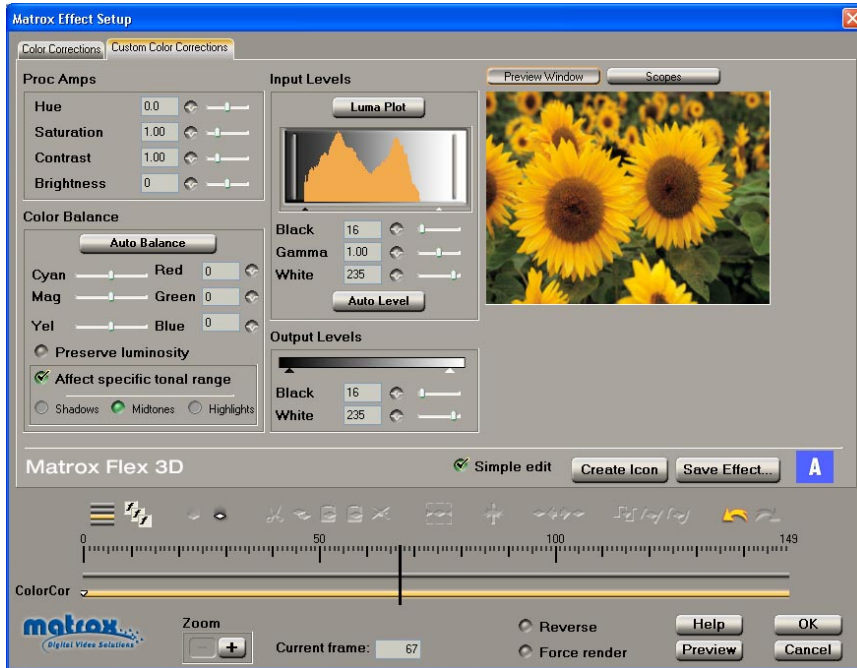

By selecting **Simple edit**, all settings are applied for the duration of your clip. This means that you'll have only one keyframe at the first frame of your clip. If you want to change settings at different frames of the clip, you'll have to clear **Simple edit**. For details on how to use the Matrox scopes to check your color correction settings, see [“Using the Matrox scopes”](#) on page 110.

You can customize your color correction using the following:

- **Proc Amps** The processing amplifier (proc amp) controls allow you to adjust different aspects of your clip:
 - **Hue** Adjusts the tint of the colors in the image.
 - **Saturation** Adjusts the saturation (vividness) of the image's colors.
 - **Contrast** Adjusts the difference in luminance between the lightest and darkest areas of the image.
 - **Brightness** Adjusts the level of black in the image.
- **Color Balance** These controls let you adjust the mixture of colors in your clip.



Note By default, any changes you make to the color balance (cyan to red, magenta to green, or yellow to blue) affect your clip globally, from the lightest white to the darkest black. To affect only shadows, midtones, or highlights, you'll need to select **Affect specific tonal range**.

- **Auto Balance** When you click this button, an eyedropper tool appears over your image in the **Preview Window**. Click the eyedropper tool on an area of white or gray in your image. This automatically applies a color shift to your clip to compensate for different lighting conditions.



Tip You can also use a keyboard shortcut to select **Auto Balance**. Press A, then use the eyedropper tool.

- **Color sliders** Drag a slider toward a color you want to increase in your clip, or away from a color you want to decrease. You can also enter a value in the text box beside each slider. Increasing a color by a certain value automatically decreases the opposite color by the same value. For example, if you move the **Cyan/Red** slider towards red, you also decrease cyan by the same amount, as shown in the following diagram:

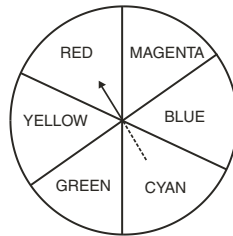

- **Preserve luminosity** Select this to maintain the luminosity values (tonal balance) in your clip while changing colors.
- **Affect specific tonal range** Select this to make color balance changes to only one of the following tonal ranges:
 - **Shadows** Affects the darkest areas of your clip.
 - **Midtones** Affects the areas with tones between the darkest and lightest areas of your clip.
 - **Highlights** Affects the lightest areas of your clip.
- **Input Levels** These controls let you fine-tune your clip's brightness and contrast by changing the luminance value that represents black, white, or gray. Doing so expands or compresses the range of luminance levels in your clip, which increases or decreases your clip's tonal range.

For example, by moving the black triangle to the right, you set black in your clip to a higher luminance value, which compresses the luminance range and darkens your clip proportionally.

- **Luma Plot** Click this to plot the luminance values in the current frame of your clip to the histogram (the plot will reflect any color correction changes you’ve made). Each luminance value present in your image appears as a vertical line in the histogram. A longer line indicates a higher amount of pixels in your image of that line’s luminance value.
- **Black** Use the black triangle under the histogram or the slider to define black in your clip.
- **Gamma** Use this to adjust the midtones in your clip without affecting black or white.
- **White** Use the white triangle under the histogram or the slider to define white in your clip.
- **Auto Level** Click this to define the darkest and lightest pixels in your clip as black and white, respectively. The intermediate luminance values are proportionally redistributed.
- **Output Levels** These controls let you map the values under **Input Levels** to any level of black and white. Use the black and white triangles or the sliders to achieve results such as reducing contrast in your clip, or reversing the luminosity of your clip by setting black to a higher value than white.

Using the Matrox scopes

The Matrox vectorscope/waveform monitors are software oscilloscopes that let you examine the video signal components of your clips. The Matrox scopes offer various tools for analyzing different aspects of your clips (they do not affect the video signal itself). If any adjustments are necessary based on the results, you can use the color correction controls to make these adjustments.



Note Because your analog video is converted to a digital signal when input to RT.X100 Xtreme, the Matrox vectorscope and waveform values provide an analysis of your video in digital format only. Therefore, you can’t analyze the blanking, sync, or color burst signals. Be aware that the values for the digital signal may vary slightly from those of the analog signal output from RT.X100 Xtreme (converted from digital back to analog).

In the following sections we explain:

- How to select and view the various scopes.
- What each scope does.
- How to use the scopes to make different types of adjustments.

Selecting and viewing the scopes

There are different ways you can select and view the various Matrox scopes. When you click the **Scopes** button, the **Image View** and **Scope View** tabs are available:



- **Image View** Lets you select the area of your clip that you want to analyze:
 - **Analyze a line** Drag the line in the **Image View** window to the line you want to analyze, or enter a line number in the text box.



Note You can select only the even lines in your clip.

- **Analyze a rectangle** Click and drag in the **Image View** window to select a rectangular area that you want to analyze. The text box displays the coordinates of your rectangle.
- **Analyze image** This selection allows you to analyze your complete image.

- **Scope View** Displays the Matrox scopes. You can change the settings to select which scopes you want to see, and how you want them to appear by clicking the ▼ button on the right side of the **Scope View** page:

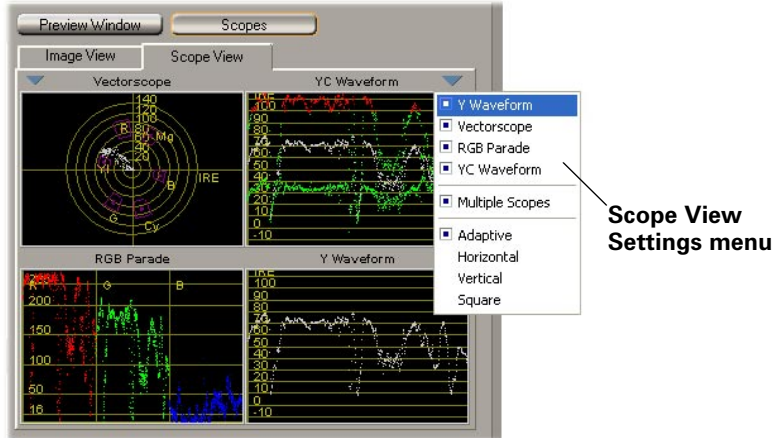

As you move your mouse within each monitor (vectorscope or waveform), you'll see a crosshair at your chosen position, and the values at that position are shown in the top right corner of the monitor.



Tip Double-click or drag the **Scope View** tab to display the Matrox scopes in a separate window that you can move and resize. This also allows you to keep **Image View** open at the same time.

Scope definitions

There are four different monitors to help you analyze your video clips:

- **Vectorscope** Shows the phase and amplitude of the color components of your video signal. Standard “targets” (small boxes) on the vectorscope correspond to the six colors in a standard color bar pattern (red, green, blue, yellow, cyan, and magenta). Color bars are usually analyzed with the vectorscope. By analyzing color bars from your source video on the vectorscope, you can make adjustments as needed to calibrate your video. For details on how to calibrate your video, see [“Calibrating video using color bars”](#) on page 113.
- **YC Waveform** Shows a representation of the combined luminance (Y) and chrominance (C) of your video. For information on interpreting the YC waveform results, see [“Ensuring legal colors for broadcast”](#) on page 114.
- **Y Waveform** Shows only the luminance (Y) values of your video, with the chrominance removed (as if your clip was in black and white).

- **RGB Parade** Shows the red, green, and blue components of your video in three side-by-side columns. For information on interpreting the RGB parade results, see “[Matching colors with the Matrox scopes](#)” on page 115.

Calibrating video using color bars

Video professionals use color bars on their tapes to ensure that video clips are calibrated for correct color and brightness. Adjustments can be made based on the results of analyzing the color bars from your source video on the vectorscope and Y waveform:

- 1 Place a clip containing color bars (captured from your tape) on the Timeline and apply the Matrox color correction effect to the clip.
- 2 Select the **_Dud** effect from the **Effect List**.
- 3 Click the **Custom Color Corrections** tab, then click **Scopes**.
- 4 On the **Image View** page, select **Analyze a line**. Select a line in your color bar pattern that includes only the colored bars representing red, green, blue, magenta, cyan, and yellow.
- 5 Double-click the **Scope View** tab to display the Matrox scopes in a separate window. From the **Scope View Settings** menu, choose **Vectorscope**.
- 6 Choose the appropriate color bar pattern from the **Vectorscope Settings** menu (click the  button on the left side of the vectorscope):

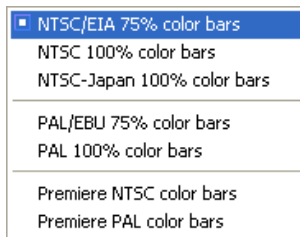

 **Important** Make sure you choose the type of color bars that matches the color bars you’re analyzing from your source video.

- 7 Check if the dots representing the colors in your color bar pattern appear within their respective targets on the vectorscope display. These targets are where the dots should appear if the color is correctly calibrated (that is, the saturation and phase relationships are correct). If needed, you can adjust the proc amp controls to get the dots as close as possible to the target boxes. Use the **Hue** control to rotate the dots around the circular graph, and use the

Saturation control to move the dots closer to or farther from the center of the graph.



Dot aligned in blue target

- 8 You can also check the white levels in your color bar pattern. From the **Scope View Settings** menu, choose **Y Waveform**. The gray or white color bar corresponds to a line on the waveform (usually the first line at the left). The IRE or mV level of this line should match the type of color bars you are using. If needed, use the **Brightness** and **Contrast** proc amp controls so that the proper IRE or mV level is set. For example, when using **NTSC/EIA 75% color bars**, adjust the **Brightness** control so that the level of IRE for the gray portion of your color bars is set to 75.

Tip You can save these modifications as a custom effect so that you can quickly calibrate all your clips from the same source tape. For details on how to save your effect for future use, see [“Common controls on the Custom pages”](#) on page 87.

Ensuring legal colors for broadcast

Many television studios require that a video clip’s luminance (Y) and chrominance (C) values don’t exceed 100 IRE on an NTSC system, or 700 mV on a PAL system. These are the highest “legal” levels for broadcast video. To ensure that your clip’s levels are legal for broadcast:

- 1 Place your clip on the Timeline and apply the Matrox color correction effect to the clip.
- 2 Select an effect from the **Effect List**.
- 3 Click the **Custom Color Corrections** tab, then click **Scopes**. On the **Image View** page, select **Analyze image**.
- 4 Double-click the **Scope View** tab to display the Matrox scopes in a separate window.
- 5 From the **Scope View Settings** menu, choose **YC Waveform**.
- 6 Scrub through your clip, and make sure that there are no red dots in the waveform monitor (levels exceeding 100 IRE or 700 mV show as red).
- 7 If needed, lower the **Brightness** and/or **Saturation** proc amp controls, until there are no red dots in the waveform monitor.

Matching colors with the Matrox scopes

To match color between two clips (such as skin tone, sky, etc.):

- 1 Place the clip that has the correct colors on the Timeline, and apply the Matrox color correction effect to the clip.
- 2 Select an effect from the **Effect List**.
- 3 On the **Image View** page, select **Analyze a rectangle**, then click and drag in the **Image View** window to select the area containing the colors you want to match.
- 4 Double-click the **Scope View** tab to display the Matrox scopes in a separate window.
- 5 From the **Scope View Settings** menu, choose **RGB Parade**.
- 6 Place the crosshair in the **RGB Parade** over the section containing the colored dots under each of the R, G, and B columns, and take note of the corresponding R, G, and B values displayed in the top right corner.
- 7 Set up a Matrox color correction on the other clip whose colors you want to match to the first clip.
- 8 Click and drag in the **Image View** window to select the area containing the colors you want to match to the first clip.
- 9 Double-click the **Scope View** tab, then use the **Color Balance** controls to adjust the colors to match the R, G, and B values you noted for your other clip. For example, place the crosshair over the red pixels under the R column, and adjust the **Cyan/Red Color Balance** slider until the R value matches the R value in your other clip.

Applying a pre-created colorization effect

When you apply a Matrox colorization effect, the **Colorization** page appears:

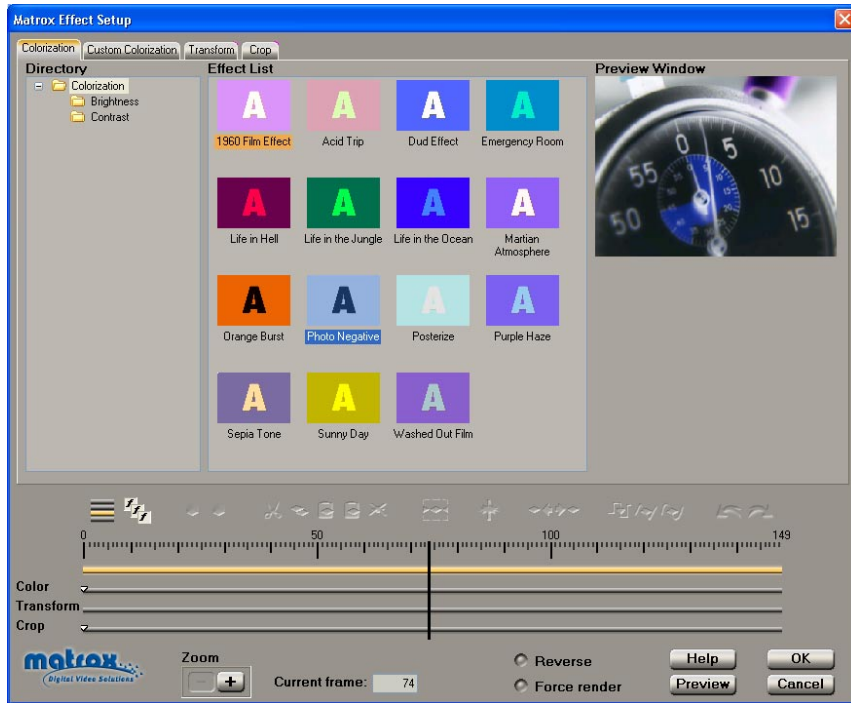

⇒ **To set up a colorization effect:**

- 1 Choose the type of effect you are looking for in the **Directory**.
 - 2 Click the particular effect you want from the **Effect List**.
- Tip** If you want to modify your clip without using any of the pre-created settings, select the **Dud Effect**.
- 3 To change the settings for your selected colorization effect, click the **Custom Colorization** tab or the **Color** track. For details on each of the available settings, see “[Creating a custom colorization effect](#)” on page 117.
 - 4 To see a preview of your effect at any time, click the **Preview** button.
 - 5 If you want to apply or change various transform settings, such as to change your clip’s size, position, and rotation settings, see “[Transforming your clip](#)” on page 149.
 - 6 When you are satisfied with your effect, click **OK** to return to your Timeline.

Creating a custom colorization effect

To customize the settings for your colorization effect, click the **Custom Colorization** tab or the **Color** track:



You can customize your effect using the following:

- **Photo Negative** Select this to create a photo negative effect by inverting the luminance and chrominance information of your clip. This setting is active for the duration of your clip.
- **Border Softness** Use this to adjust the softness on the border of your clip.
- **Brightness** Adjusts the brightness (luminance) of your image.
- **Contrast** Adjusts the difference in brightness between the lightest and darkest areas of your image.



Tip If you'll be changing the settings for **Color Gain** or **Color Addition**, you may want to adjust the **Brightness** and **Contrast** settings afterwards, such as to improve the overall brightness of your clip.

- **Color Gain** and **Color Addition (Red, Green, Blue)** You can use the controls under **Color Gain** and **Color Addition** to individually fine-tune the colors of your image. To proportionally increase or decrease the red, green, and blue values, select **Lock Red, Green, and Blue sliders**.

- The **Color Gain** controls for **Red**, **Green**, and **Blue** let you increase or decrease the intensity of a particular color present in your image. For example, increasing the **Red** value increases **only** the red color component of your image, without affecting the other colors.
- **Color Addition** lets you adjust all colors in your image by a given amount of **Red**, **Green**, or **Blue**. For example, increasing the **Red** value increases the amount of red throughout your **entire** image.
- **Color Gain and Color Addition (Alpha)** The **Alpha** controls under **Color Gain** and **Color Addition** let you adjust the transparency levels of your image's alpha channel. You can use these controls for any clip in which there is alpha-key information (such as *.tga* and *.icg* clips on Video 2 or higher). You can also use the **Alpha** controls to adjust the transparency of *.avi* clips (these clips are assumed to have a 100% opaque alpha component).
 - Use the **Alpha** control under **Color Gain** to adjust the opaque and semi-transparent areas of the alpha-key information in your image. When you increase the **Alpha Gain**, fewer and fewer alpha values are included in the key (that is, fewer alpha values become partially transparent, giving you a sharper-edged key). When you decrease the **Alpha Gain**, the opaque and semi-transparent areas become more transparent, giving you a softer key.
 - Use the **Alpha** control under **Color Addition** to adjust **all** of the alpha-key values of your image (from 100% transparent to 100% opaque). For example, drag the **Alpha Addition** slider to the right to make all the alpha values more opaque, or drag the slider to the left to make all the alpha values more transparent.



Tip Adjustments always apply to **Color Gain** first, so any changes you make to the **Color Addition** controls take into account the amount of gain specified. If you adjust the **Color Gain** controls after making changes to the **Color Addition** controls, you won't see the effect of your changes in the **Preview Window**.

Applying a pre-created cube effect

When you apply a Matrox cube effect, the **Cubes** page appears:

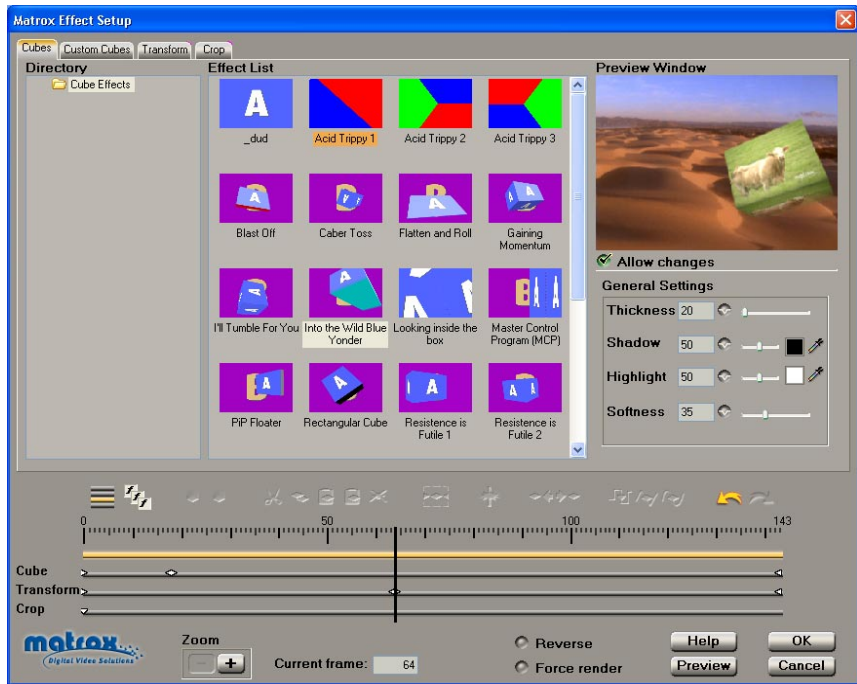



⇒ To set up a cube effect:

- 1 Choose the type of effect you are looking for in the **Directory**.
- 2 Click the particular effect you want from the **Effect List**.



Note If you want to modify your clip without using any of the pre-created settings, select the **_dud** effect.

- 3 To see a preview of your effect at any time, click the **Preview** button.
- 4 To change the settings for your cube effect, select **Allow changes**, then use the cube modifiers as follows:
 - **Thickness** Specifies the width between the front and back sides of your cube, in pixels. This sets the depth of your cube.
 - **Shadow** Adjusts the intensity of the shadow on the side of the cube that is spinning downwards. Click the  button to select the color of your shadow.
 - **Highlight** Adjusts the intensity of the highlight on the side of the cube that is spinning upwards. Click the  button to select the color of your highlight.

- **Softness** Lets you adjust the softness of the outer edge or border on your cube.
- 5 If you want to apply custom settings to your effect, see [“Creating a custom cube effect”](#) on page 121.
 - 6 If you want to apply or change various transform settings, such as to change your clip’s size, position, and rotation settings, see [“Transforming your clip”](#) on page 149.
 - 7 When you are satisfied with your effect, click **OK** to return to your Timeline.

Creating a custom cube effect

To customize the settings for your cube effect, click the **Custom Cubes** tab or the **Cube** track:

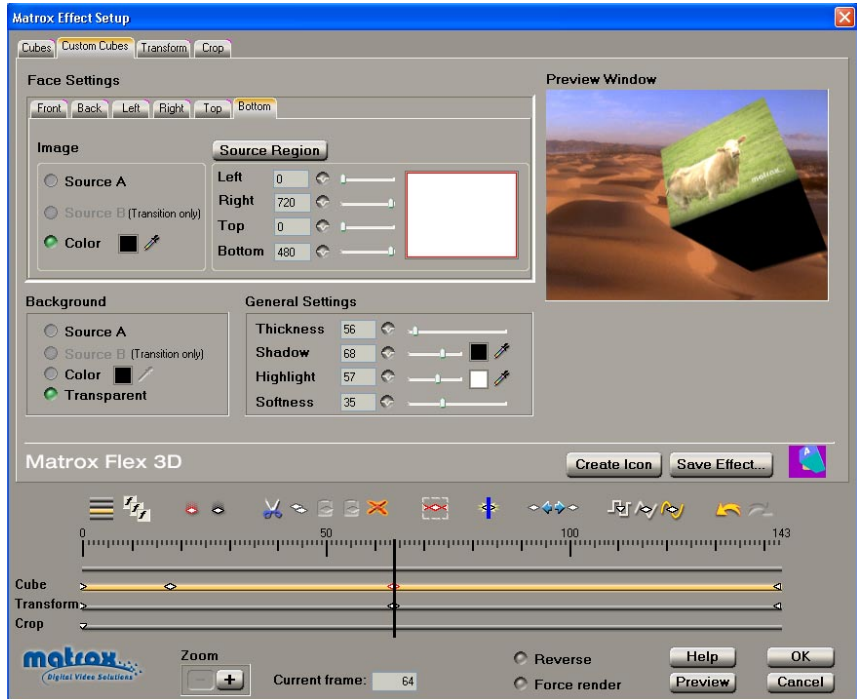



Note To see the full impact of your settings for the cube effect, you need to apply various transform settings. To learn about changing your clip's size, position, and rotation settings, see [“Transforming your clip”](#) on page 149.

Any settings that you applied under **Allow changes** on the **Cubes** page are carried over to the **Custom** page. You can further customize your effect using the following:

- **Face Settings** Use these settings to specify what you want to be mapped to each side of your cube. To choose which side you would like to modify, click the respective tab. You can customize each side by using the following controls:
 - **Image**
 - **Source A** Applies the image on the Video 1A track.
 - **Source B** Applies the image on the Video 1B track (available only if you applied the cube effect as a transition).
 - **Color** Applies a solid color. Click the  button to select the color you want.

- **Source Region** Defines the area of the image that is mapped to the side of the cube. Changes you make to the **Source Region** can be seen in the small window to the right of the controls.
 - **Left** Adjusts the left perimeter of the image.
 - **Right** Adjusts the right perimeter of the image.

The left and right values can be inverted to horizontally flip the image.
 - **Top** Adjusts the top perimeter of the image.
 - **Bottom** Adjusts the bottom perimeter of the image.

The top and bottom values can be inverted to vertically flip the image.
- **Background** Specifies an image, color, or transparency as the background to your cube.
 - **Source A** Applies the image on the Video 1A track.
 - **Source B** Applies the image on the Video 1B track (available only if you applied the cube effect as a transition).
 - **Color** Applies a solid color. Click the  button to select the color you want.
 - **Transparent** Applies a transparent background. When used for a video effect, the underlying image on the lower track becomes the background to your cube. When used for a transition, the background remains black.
- **General Settings**
 - **Thickness** Specifies the width between the front and back sides of your cube, in pixels. This sets the depth of your cube.
 - **Shadow** Adjusts the intensity of the shadow on the side of the cube that is spinning downwards. Click the  button to select the color of your shadow.
 - **Highlight** Adjusts the intensity of the highlight on the side of the cube that is spinning upwards. Click the  button to select the color of your highlight.



Important When you save a custom cube effect, it will be saved with the appropriate file extension in the corresponding directory. For example, when you save a custom transition, it will be saved with the *.CubeT.kft* extension in the *Program Files\MatroxX.tools\Effects\Cube Transition* directory. When you save a custom video effect, it will be saved with the *.CubeF.kft* extension in the *Program Files\Matrox X.tools\Effects\Cube Effects* directory.

Customizing your cube effect using the Preview Window

In the **Preview Window**, you can use your left or right mouse button to change the **Source Region** settings. You must first click the **Source Region** button, or press **Q**. You'll notice that the values will change as you drag the mouse in the **Preview Window**.

The following table shows the available mouse controls for working in the **Preview Window**.

Action	Result
Left mouse button, drag left or right	Adjusts left perimeter
Right mouse button, drag left or right	Adjusts right perimeter
Left mouse button, drag up or down	Adjusts top perimeter
Right mouse button, drag up or down	Adjusts bottom perimeter

Overview of the luma key effect

You can use the Matrox realtime plug-in to apply a luma key to make certain areas of a foreground video clip transparent based on the luminance in that image, so that an underlying video clip can show through.

In the following example of a luma key effect, two video clips are combined to produce the effect of two cowboys riding through fire. Our foreground image is a video clip of a ring of fire against a black background, and our underlying image is a video clip of two men riding horses:



Foreground image

+



Underlying image

By luma keying on the particular luminance (brightness) of the black areas in the foreground clip, these areas become transparent and the corresponding areas of the underlying image show through in the composite image as follows:

=



Result of luma key



Important You must apply the Matrox luma key effect to the clip that contains the luminance on which you want to key (that is, your foreground image on a superimpose track). To create a realtime luma key effect, both the foreground and underlying images must be video clips. If you want to use a graphics clip, you can export that clip from the Timeline to a single-frame *.avi* file, then replace the graphics clip on the Timeline with your exported file.

Creating a luma key effect

To create a luma key effect, select either **Key Black** or **Key White** from the **Effect List**. This lets you key on black or white in your foreground image. If you want to customize your luma key effect, click the **Custom Luma Keys** tab or the **Luma Key** track:

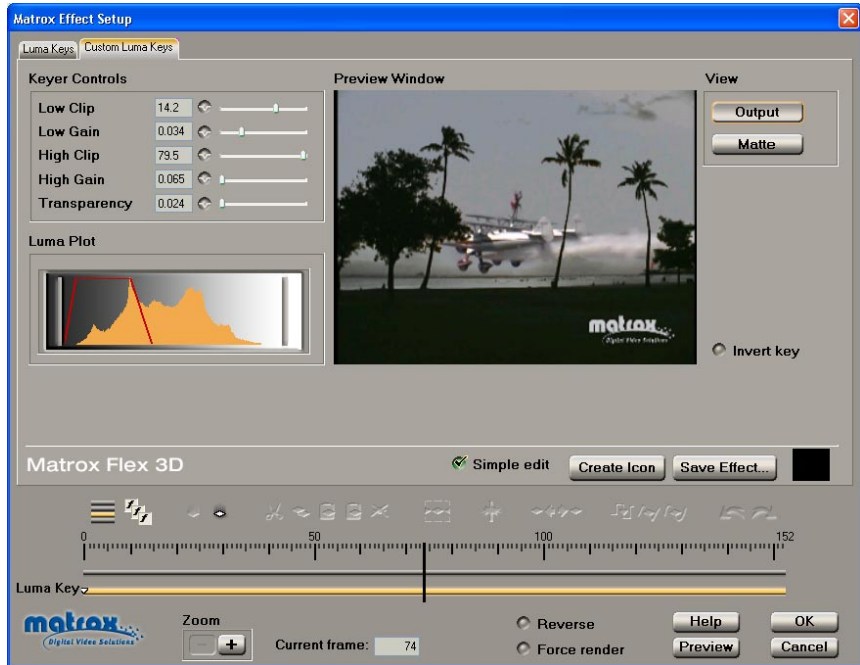

By selecting **Simple edit**, all settings are applied for the duration of your clip. This means that you'll have only one keyframe at the first frame of your clip. If you want to change settings at different frames of the clip, you'll have to clear **Simple edit**.

You can select luminance values on which to key by adjusting the **Low Clip** and **High Clip** controls. You can also adjust the softness of your key with the **Low Gain**, **High Gain**, and **Transparency** controls. All these adjustments affect the shape and size of the luminance selector (see Luma Plot on [page 126](#)) as follows:

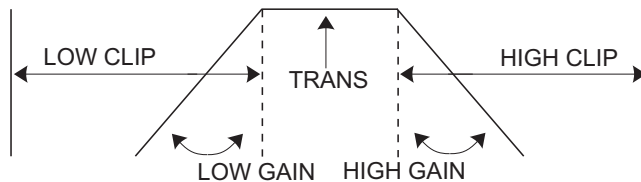

Here's an explanation of how to use each control:

- **Low Clip** Use this to select the lower (darker) luminance values to be keyed. A **Low Clip** setting of 0 represents black, and a setting of 255 represents white. Intermediate settings represent different shades of gray, from very dark to very light gray.
- **Low Gain** Use this to set the range of luminance values you want to be partially transparent based on the value set by the **Low Clip** control. As you increase the **Low Gain** setting, more luminance values become partially transparent to give you a softer-edged key.

A **Low Gain** setting of 1.000 provides the widest range for maximum softness. Alternately, a gain setting of 0 creates a hard key where the luminance values are either completely transparent or opaque. You can think of the **Low Gain** control as defining a “Transparent to Opaque” range for keying the dark areas of your foreground image.

- **High Clip** This control is similar to **Low Clip**, except you use it to select the higher (brighter) luminance values to be keyed.
- **High Gain** This control is similar to **Low Gain**, except you use it to set the range of luminance values you want to be partially transparent based on the value set by the **High Clip** control. You can think of the **High Gain** control as defining an “Opaque to Transparent” range for keying the lighter areas of your foreground image.



Note The values you can select using the **Low Clip** and **Low Gain** controls are dependent on the **High Clip** and **High Gain** controls, and vice versa. This prevents the low and high controls from keying on the same luminance values.

- **Transparency** Use this control to set the overall transparency level of your foreground image. Higher values indicate higher transparency. For example, a **Transparency** value of 1.000 makes your foreground image completely transparent, leaving only your underlying image visible.
- **Invert key** Select this to invert your key effect, giving you the opposite result of what you originally selected. Previously transparent areas become opaque, and opaque areas become transparent.
- **Luma Plot** This consists of a luminance spectrum with a plot that shows each luminance value present in your image as a vertical line in the histogram. A longer line indicates a higher amount of pixels in your image of

that line's luminance value. Adjustments made to the **Keyer Controls** affect the shape and size of the luminance selector in the **Luma Plot**:

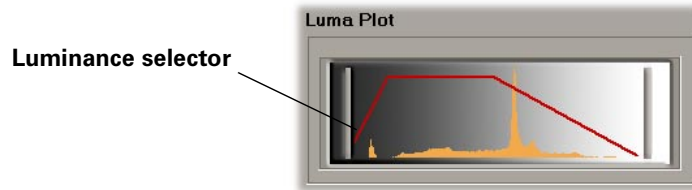

Tip Select the **Output** or **Matte** view button to plot your clip's current frame.

Viewing and selecting your luminance values

There are two different ways of viewing and selecting the luminance values on which you want to key. To switch between the views, you can click the appropriate button, or you can use the following keyboard shortcuts: **Q** for **Output**, and **W** for **Matte**.

- **Output** This is the default view when you first display the **Custom Luma Keys** page. You can see the result of your luma key effect in the **Preview Window**. You can click and drag in the **Preview Window** to select a rectangular area containing the luminance values on which you want to key. The tracking rectangle stays visible until you let go of the mouse button. The keyer controls are adjusted to reflect your selected values. You can also add to the previously selected luminance values by holding down the **CTRL** key and selecting a new rectangular area.

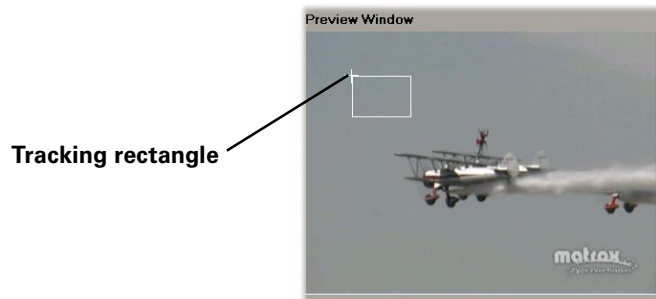

- **Matte** This view displays the matte used to create your key effect. In the following example, you can see a white silhouette against black, with semi-transparent areas seen as grays. As explained for the **Output** view, you can use the tracking rectangle in the **Matte Window** to select an area containing the luminance values on which you want to key.



Applying a pre-created mask DVE effect

When you apply a Matrox mask DVE effect, the **Mask DVEs** page appears:

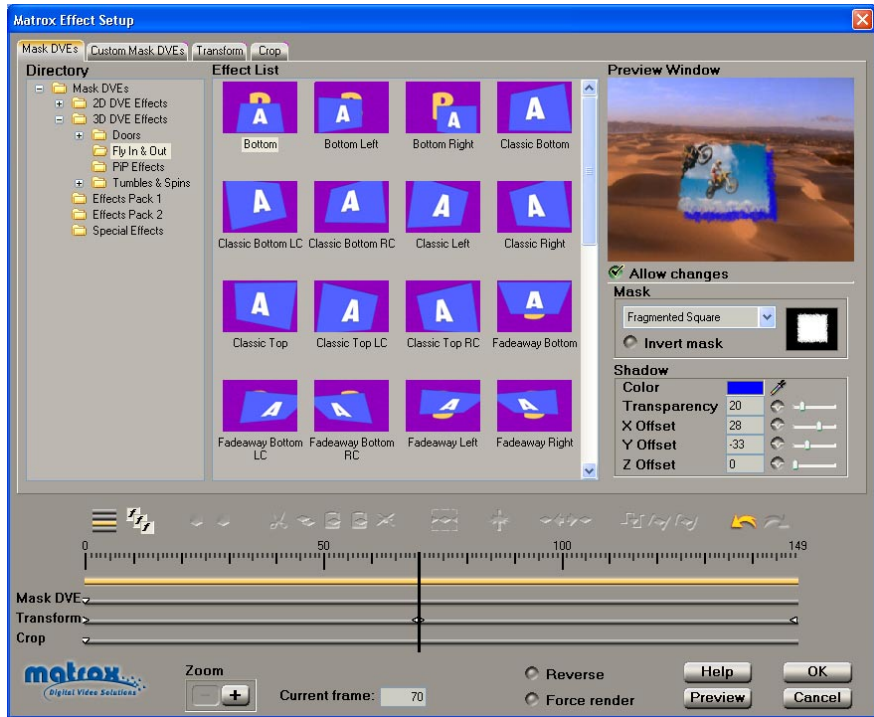



➔ To set up a mask DVE effect:

- 1 Choose the type of effect you are looking for in the **Directory**. For example, click the **PIP Effects** folder under **3D DVE Effects** to display a list of available 3D picture-in-picture effects.
- 2 Click the particular effect you want from the **Effect List**.



Note The effects in this **Effect List** are the same as on the **Advanced DVEs** page, but with the default mask pattern applied.

- 3 To see a preview of your effect at any time, click the **Preview** button.
- 4 To change the pattern for your mask effect, select **Allow changes**, then use the list under **Mask** to select a pattern. You can see an icon representing your selected mask pattern.
- 5 If you want to invert the opaque and transparent areas of your effect, select **Invert mask**.
- 6 To display a shadow behind your mask pattern, make sure that **Allow changes** is selected, then use the **Shadow** modifiers as follows:

- **Color** Click the  button to select the color of your shadow.
 - **Transparency** Sets the transparency of your shadow. Levels range from opaque (0) to fully transparent (100).
 - **X Offset** Sets the position of your shadow with respect to the left and right edges of your mask pattern. Negative numbers move the shadow to the left, and positive numbers move the shadow to the right.
 - **Y Offset** Sets the position of your shadow with respect to the top and bottom edges of your mask pattern. Negative numbers move the shadow to the bottom, and positive numbers move the shadow to the top.
 - **Z Offset** Sets the depth of your shadow behind your mask pattern.
- 7 If you want to apply custom settings to your effect, see [“Creating a custom mask DVE effect”](#) on page 131.
 - 8 If you want to apply or change various transform settings, such as to change your clip’s size, position, and rotation settings, see [“Transforming your clip”](#) on page 149.
 - 9 When you are satisfied with your effect, click **OK** to return to your Timeline.
-  **Tip** You can also add your own mask patterns, which you can select from the **Mask** list. For details, see [“Adding your own mask patterns”](#) on page 132.

Creating a custom mask DVE effect

To customize the settings for your mask DVE effect, click the **Custom Mask DVEs** tab or the **Mask DVE** track:



Any settings that you applied under **Allow changes** on the **Mask DVEs** page are carried over to the **Custom** page. You can further customize your effect using the following:

- **Mask**
 - Use the **Mask** list to change the pattern for your mask effect. You can see an icon representing the selected mask pattern.
 - If you want to invert the opaque and transparent areas of your effect, select **Invert mask**.
 - **Position X** and **Position Y** Use these controls to move your mask pattern to various positions.
 - **Size X** and **Size Y** Use these controls to resize your mask pattern. You can adjust the size controls individually, or if you select **Fixed aspect ratio**, you only need to adjust one axis, and the other one automatically takes the same value.

Tip You can also adjust the position and size of your mask pattern in the **Preview Window** using your mouse. Left-click and drag to adjust the position controls, and right-click and drag to adjust the size controls.

- **Outside Transparency** Sets the transparency level of the area around your mask pattern.
- **Shadow** These settings can also be found under **Allow changes** in the **Mask** page:
 - **Color** Click the  button to select the color of your shadow.
 - **Transparency** Sets the transparency of your shadow. Levels range from opaque (0) to fully transparent (100).
 - **X Offset** Sets the position of your shadow with respect to the left and right edges of your mask pattern. Negative numbers move the shadow to the left, and positive numbers move the shadow to the right.
 - **Y Offset** Sets the position of your shadow with respect to the top and bottom edges of your mask pattern. Negative numbers move the shadow to the bottom, and positive numbers move the shadow to the top.
 - **Z Offset** Sets the depth of your shadow behind your mask pattern.

Adding your own mask patterns

The mask DVE effect works like a track matte key effect, in that it allows you to superimpose one clip on another using an 8-bit grayscale *.tga* pattern to integrate the two clips. Areas of white in your mask pattern create an opaque area that prevents the underlying clip from showing through. Black areas of your mask pattern create transparent areas, and gray areas create semi-transparent areas.

In the following example, we've applied the **Arches** mask DVE to the clip on the Video 2 track, which superimposes that clip in the shape of the arches pattern over the clip on the Video 1 track:



Clip on Video 2



Clip on Video 1



Mask pattern



Clips with mask

Adding your mask patterns to the Matrox library

Your new mask patterns must be added to the *Mask* folder where your other Matrox mask patterns are installed. If you chose the default location when you installed Matrox X.tools, your mask patterns will be installed at:

Program Files\Matrox X.tools\Effects\Mask DVEs

When you first apply a mask DVE effect, the **Default** pattern is selected as your mask pattern, which is the same as the **Cottony Square** pattern. If you want another mask pattern as your default, simply make a copy of your chosen pattern, and rename it to *Default.tga* to overwrite the current one.



Important To create your own mask patterns for use in a widescreen production, create them with a 16:9 aspect ratio. For more information, see “Creating a production in 16:9 format” on page 77.

Creating your own mask patterns in Adobe Photoshop LE

To create a mask pattern using Adobe Photoshop LE:

- 1 Start Adobe Photoshop LE, then choose **File > New**.
- 2 In the **New** dialog box, define the size of your image:
 - For an NTSC image, select **720 pixels** for **Width** and **480 pixels** for **Height**.
 - For a PAL image, select **720 pixels** for **Width** and **576 pixels** for **Height**.



Tip If you want to create a mask pattern for use in a widescreen (16:9) production, create your image at 853×480 (NTSC), or 1024×576 (PAL). After you’ve created your image, resize **only** its width to 720. When you do this, your graphic will appear elongated on your computer screen.

- 3 Choose **Image > Mode**, then select **Grayscale** and **8 bits/channel**.
- 4 Create your mask pattern using any of the tools in the toolbox. You may want to apply a **Gaussian Blur** filter to your pattern to soften its edges and give you a more professional looking mask.
- 5 When finished, choose **File > Save As**, name your file, select **Targa** [***.tga**, ***.vda**, ***.icb**, ***.vst**] as the file type, and select your *Mask DVEs* folder to save your pattern. The next time you apply a Matrox mask effect, your new pattern will be available from the **Mask** list.



Note While these instructions are for creating mask patterns with Adobe Photoshop LE, you can use any image-editing software—as long as you specify the correct image size, select 8-bit grayscale, and save your pattern as a *.tga* file. If your program provides the option of saving your *.tga* file as **Compressed** or **Uncompressed**, make sure you select the **Uncompressed** option.

Applying a pre-created organic wipe

When you apply a Matrox organic wipe, the **Organic Wipes** page appears:

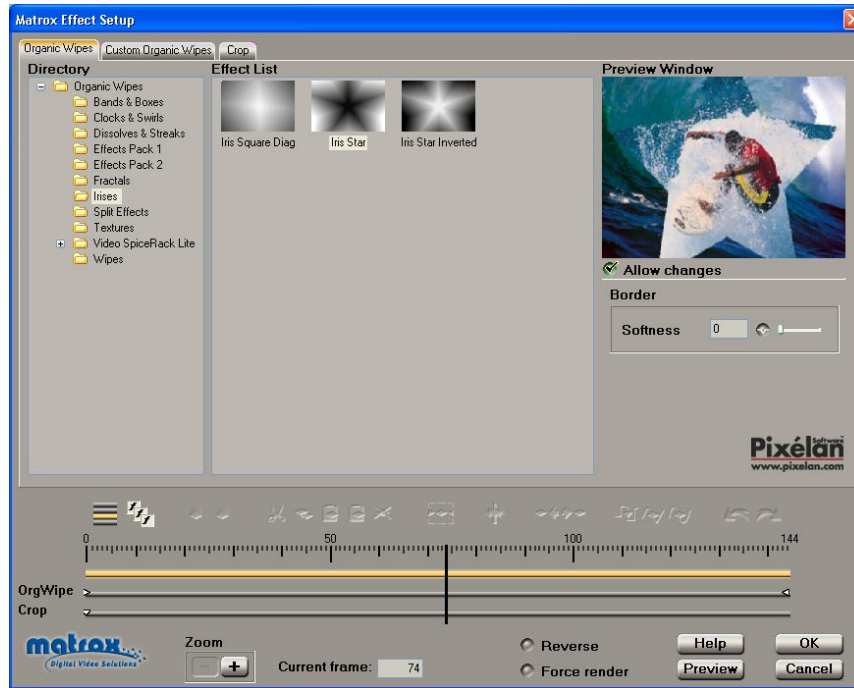

⇒ To set up an organic wipe:

- 1 Choose the type of effect you are looking for in the **Directory**.
- 2 Click the particular effect you want from the **Effect List**.
- 3 To see a preview of your effect at any time, click the **Preview** button.
- 4 To create a soft edge on the border of your organic wipe, select **Allow changes**, then drag the **Softness** slider. The higher the value, the less sharp the edge of your organic wipe becomes.
- 5 If you want to apply custom settings to your effect, see “[Creating a custom organic wipe](#)” on page 135.
- 6 When you are satisfied with your effect, click **OK** to return to your Timeline.



Note The Matrox organic wipes are not transformable (that is, the **Transform** track is not available when setting up organic wipes). You can, however, add your own patterns as explained in “[Adding your own organic wipe patterns](#)” on page 136.

Creating a custom organic wipe

To customize the settings for your organic wipe, click the **Custom Organic Wipes** tab or the **OrgWipe** track:

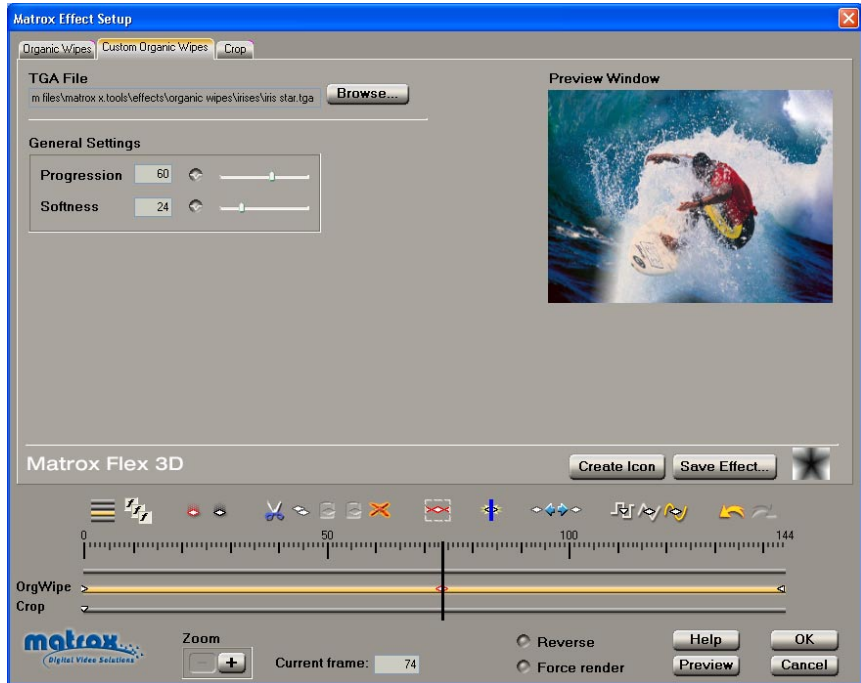

Any settings that you applied under **Allow changes** on the **Organic Wipes** page are carried over to the **Custom** page. You can further customize your effect using the following:

- **TGA File** The source file for the effect that you selected on the **Organic Wipes** page is displayed under **TGA File**. If you want to select a different effect, click **Browse** and select a new source file.
- **Progression** Sets the progression of your organic wipe pattern, at any frame. For example, you can set the progression to 50% at the first frame to make your organic wipe pattern start only at its mid-point.
- **Border Softness** Creates a soft edge on the border of your organic wipe.

Adding your own organic wipe patterns

You can create your own organic wipe patterns and add them to the Matrox realtime plug-in for use in your projects. Organic wipes use grayscale gradient patterns to switch from one image to another by gradually revealing the second image in a certain pattern. A progressive transition occurs between your initial image (Video 1A), represented by the white areas of your gradient pattern, and your final image (Video 1B), represented by the black areas.

The following pattern is used for the **2-Corner Diag** organic wipe in the Matrox plug in:

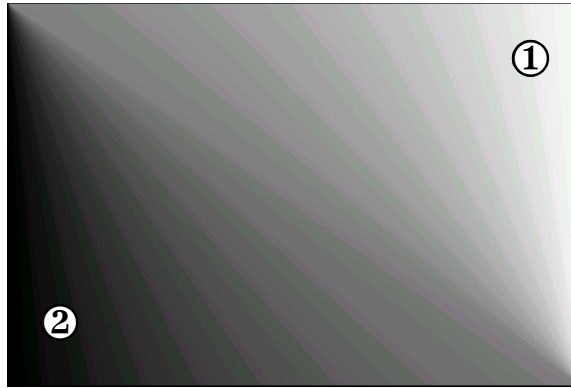

When you apply this organic wipe, you'll see it affect your clips halfway through the transition like this:



① Video 1A

② Video 1B

Creating a subdirectory for your new organic wipes

Your new organic wipes must be added to a subdirectory where you installed Matrox X.tools. If you chose the default location when you installed Matrox X.tools, your Matrox organic wipes will be installed at:

Program Files\Matrox X.tools\Effects\Organic Wipes

Under the *Organic Wipes* directory, create a new subdirectory in which to store your own organic wipe patterns, such as:

Program Files\Matrox X.tools\Effects\Organic Wipes\My Patterns

 **Important** To create your own organic wipe patterns for use in a widescreen production, create them with a 16:9 aspect ratio. For more information, see “[Creating a production in 16:9 format](#)” on page 77.

Creating your own organic wipe patterns in Adobe Photoshop LE

- 1 Start Adobe Photoshop LE, then choose **File > New**.
- 2 In the **New** dialog box, define the size of your image:
 - For an NTSC image, select **720 pixels** for **Width** and **480 pixels** for **Height**.
 - For a PAL image, select **720 pixels** for **Width** and **576 pixels** for **Height**.



Tip If you want to create an organic wipe for use in a widescreen (16:9) production, create your image at 853×480 (NTSC) or 1024×576 (PAL). After you’ve created your image, resize **only** its width to 720. When you do this, your graphic will appear elongated on your computer screen.

- 3 Choose **Image > Mode**, then select **Grayscale** and **8 bits/channel**.
- 4 Create your organic wipe pattern using any of the tools in the toolbox. The gradient tools, however, work best for creating organic wipe patterns.
- 5 When finished, choose **File > Save As**, name your file, select **Targa [* .tga, * .vda, * .icb, * .vst]** as the file type, and select your subdirectory under the *Organic Wipes* directory.
- 6 When you open your subdirectory within the Matrox realtime plug-in for Adobe Premiere, you’ll see that the new effect was found, and an icon of your pattern will be added to the **Effect List**.



Note While these instructions are for creating organic wipe patterns with Adobe Photoshop LE, you can use any image-editing software—as long as you specify the correct image size, select 8-bit grayscale, and save your pattern as a *.tga* file. If your program provides the option of saving your *.tga* file as **Compressed** or **Uncompressed**, make sure you select the **Uncompressed** option.

Applying a pre-created page curl

When you apply a Matrox page curl, the **Page Curls** page appears:

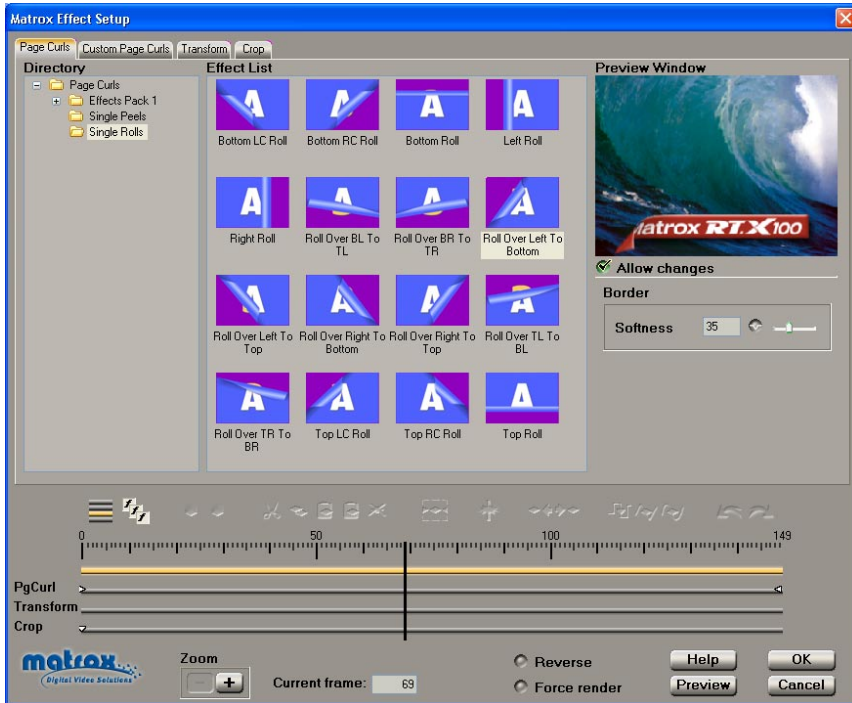

To set up a page curl:

- 1 Choose the type of effect you are looking for in the **Directory**.
- 2 Click the particular effect you want from the **Effect List**.
- 3 To see a preview of your effect at any time, click the **Preview** button.
- 4 To create a soft edge on your page curl, select **Allow changes**, then drag the **Softness** slider.
- 5 If you want to apply custom settings to your effect, see [“Creating a custom page curl”](#) on page 139.
- 6 If you want to apply or change various transform settings, such as to change your clip’s size, position, and rotation settings, see [“Transforming your clip”](#) on page 149.
- 7 When you are satisfied with your effect, click **OK** to return to your Timeline.

Creating a custom page curl

To customize the settings for your page curl, click the **Custom Page Curls** tab or the **PgCurl** track:

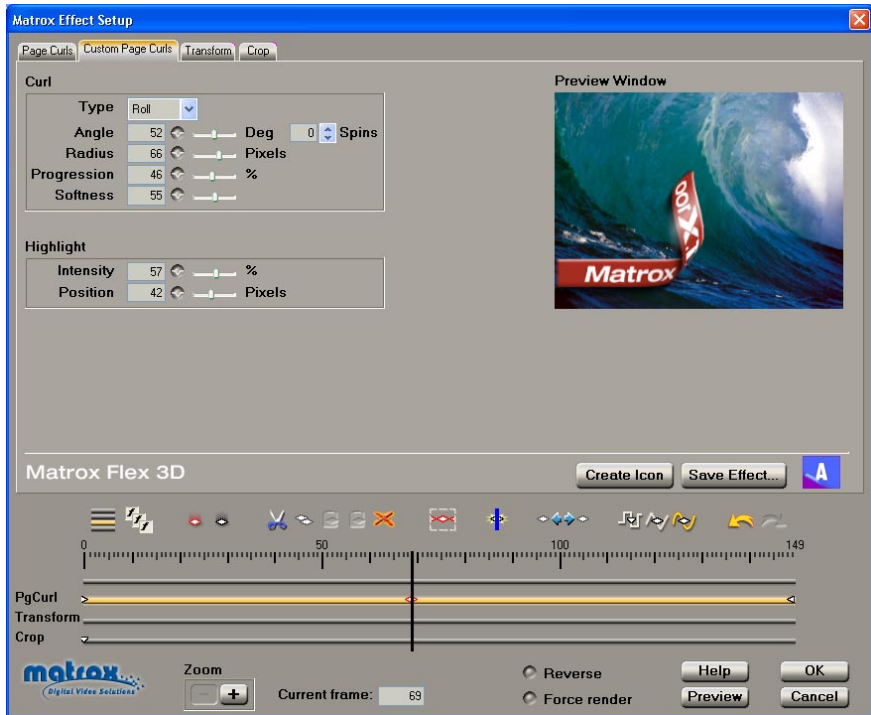

Any settings that you applied under **Allow changes** on the **Page Curls** page are carried over to the **Custom** page. You can further customize your effect using the following:

- **Curl**
 - **Type** You can select **Peel** or **Roll** as your page curl type (this setting is active for the duration of your effect).
 - **Angle** Sets the angle of your page curl, in degrees. Alternately, you can set the number of **Spins** for your page curl.
 - **Radius** Determines the tightness of your page curl. For example, a radius of 0 produces the tightest page curl, and the higher the radius, the looser the page curl.
 - **Progression** Sets the progression of your page curl pattern, at any frame. For example, you could set the progression to 50% at the first frame to make your page curl pattern start only at its mid-point.
 - **Softness** Creates a soft edge on your page curl.

- **Highlight** There is a white illuminated line that highlights each page curl. The following settings allow you to manipulate this highlight:
 - **Intensity** Sets the brightness of the highlight, as a percentage.
 - **Position** Sets the location in the page curl where the highlight appears.

Applying a pre-created particle effect

When you apply a Matrox particle effect, the **Particles** page appears:

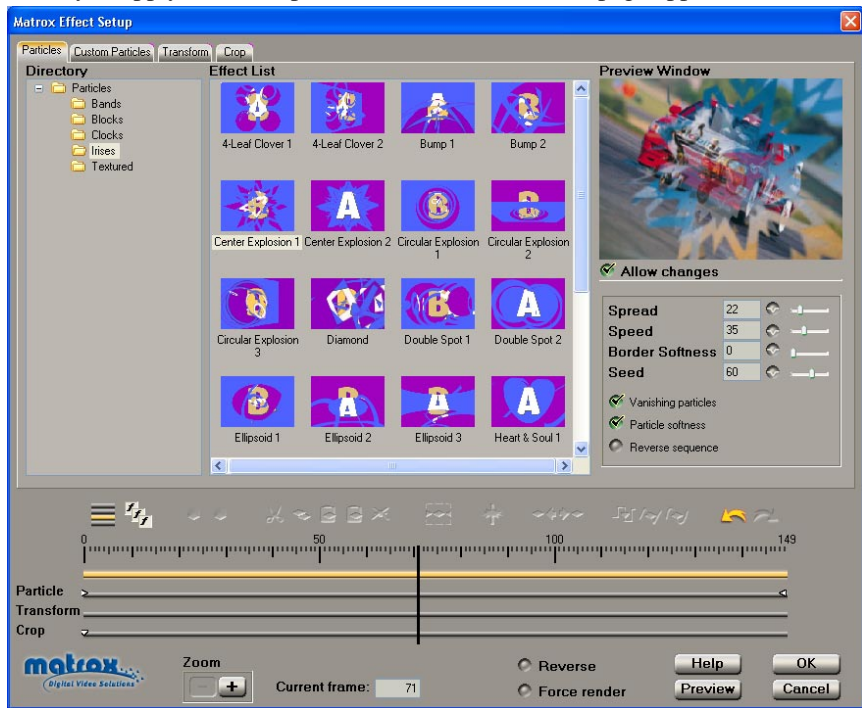

⇒ To set up a particle effect:

- 1 Choose the type of effect you are looking for in the **Directory**.
- 2 Click the particular effect you want from the **Effect List**.
- 3 To see a preview of your effect at any time, click the **Preview** button.
- 4 To change the settings for your effect, select **Allow changes**, then use the particle effect modifiers as follows:
 - **Spread** Sets the progression of the effect. The higher the spread, the closer to the beginning of your clip the particles start to explode. For example, a spread of 100 indicates that all particles start to explode at the first frame of the clip, and a spread of 20 indicates that all particles explode by the 80% point of the clip.
 - **Speed** Sets the speed at which the particles explode.
 - **Border Softness** Sets the softness on the border of your clip.
 - **Seed** Sets the random behavior of the pattern. Each value (from 0 to 100) represents a different random pattern.

- **Vanishing particles** Select this to make the particles vanish after they explode.
 - **Particle softness** Select this to soften the edges of the particles that haven't exploded yet.
 - **Reverse sequence** Select this to reverse the pattern of the effect.
- 5 If you want to apply custom settings to your effect, see [“Creating a custom particle effect”](#) on page 143.
 - 6 If you want to apply or change various transform settings, such as to change your clip's size, position, and rotation settings, see [“Transforming your clip”](#) on page 149.
 - 7 When you are satisfied with your effect, click **OK** to return to your Timeline.

Creating a custom particle effect

To customize the settings for your particle effect, click the **Custom Particles** tab or the **Particle** track:



Any settings that you applied under **Allow changes** on the **Particles** page are carried over to the **Custom** page. You can further customize your effect using the following:

- **GFX File** The pattern file for the effect that you selected on the **Particles** page is displayed under **GFX File**. If you want to select a different pattern, click **Browse**, and select a different *.gfx* file.
- **General Settings**
 - **Progression** Sets the progression of your particle effect, at any frame. For example, you can set the progression to 50% at the first frame to make your particle pattern start only at its mid-point.
 - **Spread** Determines the point at which the particles start to explode. The higher the spread, the closer to the beginning of your clip the particles start to explode. For example, a spread of 100 indicates that all particles start to explode at the first frame of the clip, and a spread of 20 indicates that all particles explode by the 80% point of the clip.
 - **Speed** Sets the speed at which the particles explode.

- **Border Softness** Sets the softness on the border of your clip.
- **Global Effect Settings** These settings are active for the duration of your effect:
 - **Seed** Sets the random behavior of the pattern. Each value (from 0 to 100) represents a different random pattern.
 - **Vanishing particles** Select this to make the particles vanish after they explode.
 - **Particle softness** Select this to soften the edges of the particles that haven't exploded yet.
 - **Reverse sequence** Select this to reverse the pattern of the effect.
- **Direction** Use these controls to determine the line along the X, Y, and Z axes that your particle pattern follows.
- **Gravity** Use these controls to pull your particle pattern along the X, Y, and Z axes. Your particle pattern accelerates in the direction of the gravity applied.
- **Dispersion** Use these controls to alter the scattering range of your particle pattern along the X, Y, and Z axes.

Customizing your particle effect using the Preview Window

In the **Preview Window**, you can use your left or right mouse button to change the **Direction**, **Gravity**, and **Dispersion** settings.



Important You must first select the type of settings you want to adjust by clicking the appropriate button (**Direction**, **Gravity**, or **Dispersion**). Alternately, you can use keyboard shortcuts to select the setting you want. Press **Q** for **Direction**, **W** for **Gravity**, or **E** for **Dispersion**. You'll notice that the values will change for the selected controls as you drag the mouse in the **Preview Window**.

The following table shows the available mouse controls for working in the **Preview Window**.

Action	Result
Left mouse button	Adjusts x and y axes
SHIFT +left mouse button, drag left or right	Adjusts x axis only
SHIFT +left mouse button, drag up or down	Adjusts y axis only
Right mouse button	Adjusts z axis only

For example, if you want to alter the dispersion of your clip on the y axis only, first click the **Dispersion** button, then press and hold **SHIFT** while dragging the mouse up or down in the **Preview Window**.

Applying a pre-created sphere effect

When you apply a Matrox sphere effect, the **Spheres** page appears:

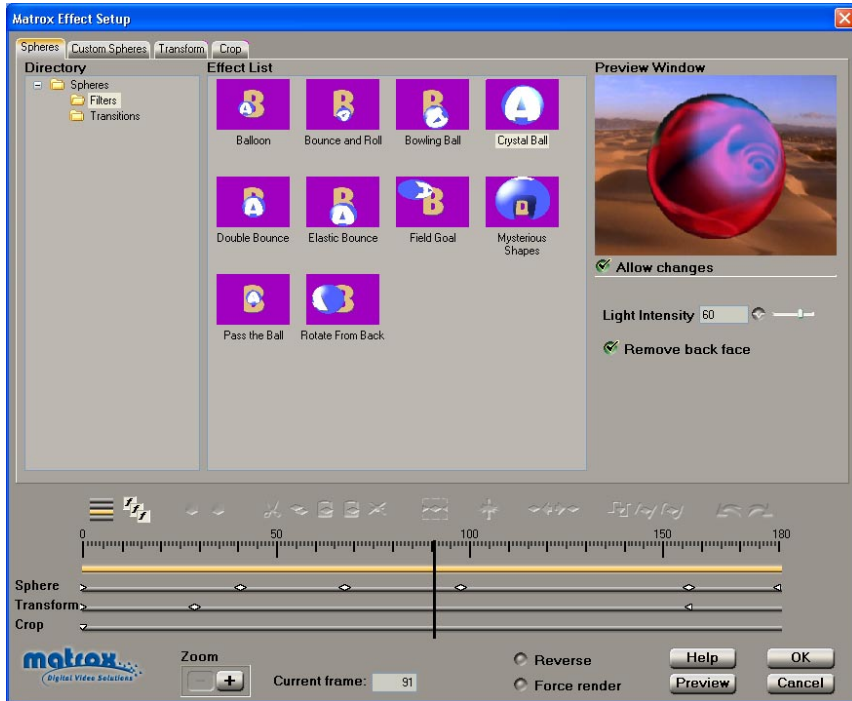

To set up a sphere effect:

- 1 Choose the type of effect you are looking for in the **Directory**.
- 2 Click the particular effect you want from the **Effect List**.
- 3 To see a preview of your effect at any time, click the **Preview** button.
- 4 To change the settings for your effect, select **Allow changes**, then use the sphere modifiers as follows:
 - **Light Intensity** Drag the slider to change the brightness of the highlight in your sphere.
 - **Remove back face** Select this option to remove the back face of your sphere. This option is useful if you're applying transparency to your clip and do not want to see the back face of your clip through your sphere.
- 5 If you want to apply custom settings to your effect, see [“Creating a custom sphere effect”](#) on page 147.
- 6 If you want to apply or change various transform settings, such as to change your clip's size, position, and rotation settings, see [“Transforming your clip”](#) on page 149.
- 7 When you are satisfied with your effect, click **OK** to return to your Timeline.

Creating a custom sphere effect

To customize the settings for your sphere effect, click the **Custom Spheres** tab or the **Sphere** track:

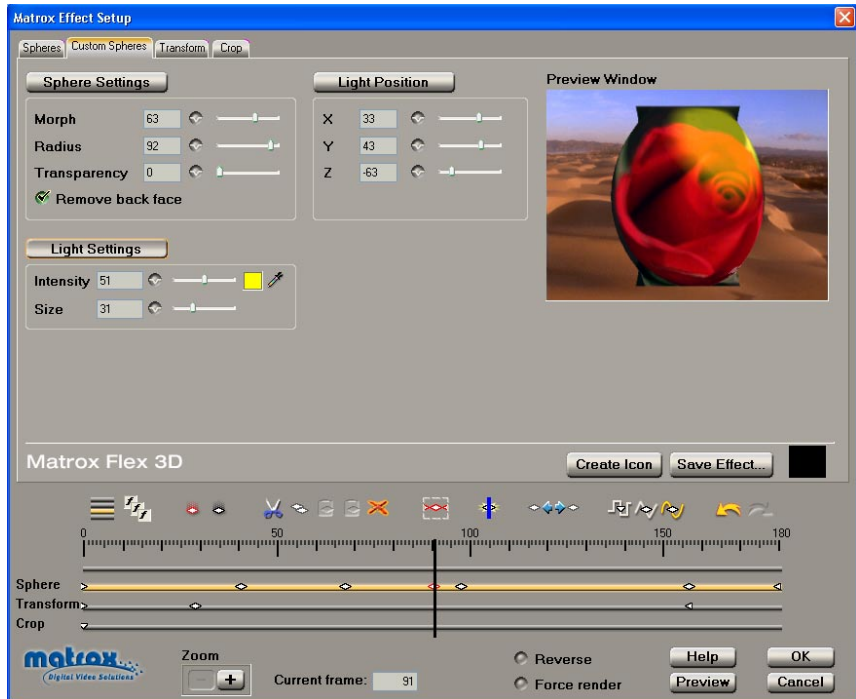

Any settings that you applied under **Allow changes** on the **Spheres** page are carried over to the **Custom** page. You can further customize your effect using the following:

- **Sphere Settings**
 - **Morph** Use this to set the shape of your sphere.
 - **Radius** Use this to set the size of your sphere.
 - **Transparency** Sets the transparency of your clip, from opaque (0) to fully transparent (100). If you're performing a sphere transition, the transparency level is applied to your initial image. For example, you can set the Transparency to 0 at the first frame and 100 at the last frame to create a crossfade between your initial and final images.
 - **Remove back face** Select this option to remove the back face of your sphere. This option is useful if you're applying transparency to your clip and do not want to see the back face of your clip through your sphere.
- **Light Position** Use these controls to determine the position of your light source along the X, Y, and Z axes of your sphere.

- **Light Settings**
 - **Intensity** Use this to change the brightness of the highlight in your sphere. You can also change the color of the highlight by clicking the  button, and selecting a new color.
 - **Size** Use this to alter the size of the highlight.

Customizing your sphere effect using the Preview Window

In the **Preview Window**, you can use your left or right mouse button to change the **Sphere Settings**, **Light Position**, and **Light Settings**.



Important You must first select the type of settings you want to adjust by clicking the appropriate button (**Sphere Settings**, **Light Position**, or **Light Settings**). Alternately, you can use keyboard shortcuts to select the setting you want. Press **Q** for **Sphere Settings**, **W** for **Light Position**, or **E** for **Light Settings**. You'll notice that the values will change for the selected controls as you drag the mouse in the **Preview Window**.

The following table shows the available mouse controls for working in the **Preview Window** for the **Sphere Settings**:

Action	Result
Left mouse button, drag left or right	Adjusts Morph
Right mouse button, drag left or right	Adjusts Radius

The following table shows the available mouse controls for working in the **Preview Window** for the **Light Position**:

Action	Result
Left mouse button, drag left or right	Adjusts X axis
Left mouse button, drag up or down	Adjusts Y axis
Right mouse button, drag left or right	Adjusts Z axis

The following table shows the available mouse controls for working in the **Preview Window** for the **Light Settings**:

Action	Result
Left mouse button, drag left or right	Adjusts Intensity
Right mouse button, drag left or right	Adjusts Size

Transforming your clip

To apply various transform settings to your clip, such as to resize, position, and rotate your clip, click the **Transform** tab or the **Transform** track:



- **Position** Lets you position your clip on x-y-z coordinates (horizontal, vertical, depth).
- **Size** Lets you resize your clip.
- **Offset** Lets you move the pivot point for rotating your clip.
- **Rotation** Lets you set the number of spins of the clip on its x, y, or z axis.

You can adjust the transform settings in the following ways:

- Use the transform controls to select the settings you want.
- Choose commands from the **Transform** menu to set a particular size and position, such as half-screen size in the bottom-right corner.
- Work directly in the **Preview Window** using your mouse. For example, you can click and drag to resize, rotate, or position your clip.



Note Many of the Matrox effects, such as advanced DVEs, already have transform settings defined as keyframes on the **Transform** track. For details on how to change a clip's transform settings over time by creating and editing keyframes, see [“Working with keyframes”](#) on page 157.

Using the transform controls

You can use the text boxes or sliders to position, resize, or rotate your clip. For information on how to use the text boxes and sliders, see [page 89](#).



⇒ There are four types of transform settings that you can work with:

- **Position** Use these controls to position your clip on the x (horizontal), y (vertical), and z (depth) axes. Values of (0,0,0) pixels align the center of your clip with the center of the screen, and positions are measured from this point. You can enter positive or negative pixel values to move your clip right or left (x), up or down (y), and forward or backward (z).
- **Size** Use these controls to make your clip smaller or larger. Full-screen size is represented as 100%. You can shrink your clip to 0% or enlarge it to 1000%. Note, however, that by enlarging your clip, the resolution may become blurry. You can adjust the size controls individually, or if you select **Fixed aspect ratio**, you only need to adjust one axis, and the others automatically take the same value. Adjusting the percentage on the x and y axes changes your clip's width and height, respectively. You'll only notice adjustments to the z axis when you have depth in your effect, such as in the advanced DVE effects.
- **Offset and Rotation** Use the **Offset** controls to set the pivot point, or center of rotation, of your clip. When **Rotation** settings are applied, your clip spins around this point. You can use positive or negative pixel values to offset your clip on the x (horizontal), y (vertical), and z (depth) axes. Each rotation of 360° produces one spin on the selected axis. You can have positive or negative rotation from -3600° to 3600°, which is equal to -10 to 10 spins, depending on the direction you want your clip to rotate.

In the illustrations below, notice how different **Offset** values can affect the rotation of the cube.

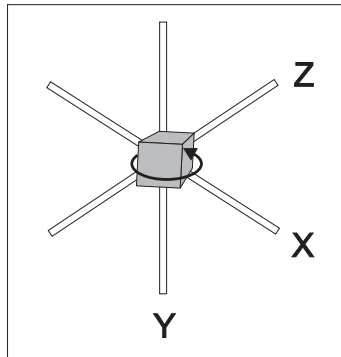

Figure 1: Offset at 0,0,0

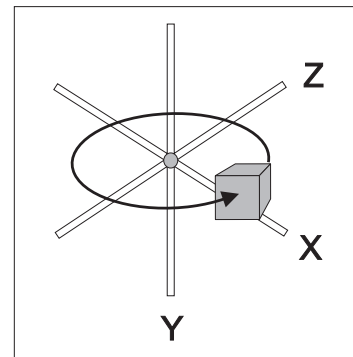

Figure 2: Offset at 100,0,0

In Figure 1, the **Offset** values are (0,0,0), so the center of rotation for the cube is where the x, y, and z axes meet. In Figure 2, the **Offset** value for the x axis is set to 100, thus moving the cube and the pivot point to the right, so when the cube is rotated, it has a wider arc when spinning around the axes.

Using the Transform menu

You can also resize and position your clip by choosing commands from the **Transform** menu, located below the **Preview Window**.



- **Default** Restores your clip to its default settings (full-screen size of 100%, and all other transform controls at 0).
- **Use Safe Title Area** Restricts the **DVE Position** presets (see below) to the Safe Title Area. This is the central area of the screen where you can safely position your clip to be sure it will be visible on all monitors.
- **DVE Size** Lets you select a preset to resize your clip. The presets range from full-screen down to invisible.
- **DVE Position** Lets you select a preset to position your clip, such as **Bottom Right**. If **Safe Title Area** is selected, it will serve as the reference for positioning your clip. If isn't selected, your clip will be positioned relative to the entire screen area.

Transforming a clip using the Preview Window

In the **Preview Window**, you can use your left or right mouse button to resize, position, and rotate your clip.



Important You must first select the type of transform settings you want to adjust by clicking the appropriate button (**Position**, **Size**, **Offset**, or **Rotation**). Alternately, you can use keyboard shortcuts to select the transform setting you want. Press **Q** for **Position**, **W** for **Size**, **E** for **Offset**, or **R** for **Rotation**. You'll notice that the values will change for the selected controls as you drag the mouse in the **Preview Window**.

The following table shows the available mouse controls for working in the **Preview Window**.

Action	Result
Left mouse button	Adjusts x and y axes
SHIFT +left mouse button, drag left or right	Adjusts x axis only
SHIFT +left mouse button, drag up or down	Adjusts y axis only
Right mouse button	Adjusts z axis only

For example, if you want to alter the position of your clip on the y axis only, first click the **Position** button, then press and hold **SHIFT** while dragging the mouse up or down in the **Preview Window**.

Cropping your effect

To apply crop settings to your Matrox effect, click the **Crop** tab or the **Crop** track:



By selecting **Simple edit**, all settings are applied for the duration of your clip. This means that you'll have only one keyframe at the first frame of your clip. If you want to change settings at different frames of the clip, you'll have to clear **Simple edit**.



Note The default crop settings that you specify in the **Matrox Advanced Settings** dialog box (see [page 52](#)) are applied to all your Matrox effects. You can customize the crop settings for individual effects by defining keyframes at any point on the **Crop** track. For details on how to change an effect's crop settings over time by creating and editing keyframes, see "[Working with keyframes](#)" on [page 157](#).

You can adjust the crop settings in the following ways:

- Crop directly in the **Cropping Window** by dragging resize handles on the image.
- Use the crop controls to crop any edge by a given number of pixels.

- Choose a command from the **Crop** menu to crop your effect by a preset amount.
- Crop directly in the **Preview Window** using your mouse.

Using the Cropping Window

The **Cropping Window** allows you to adjust a cropping area using eight resize handles.

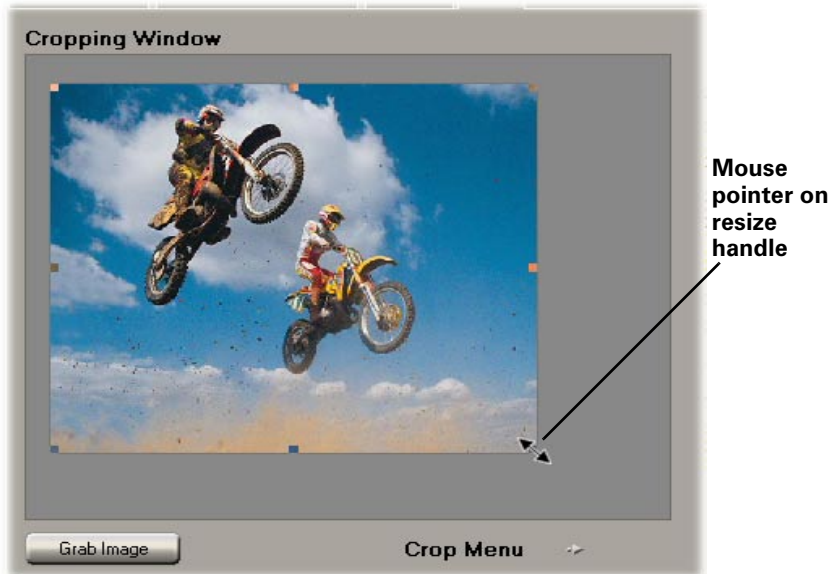

To display a particular frame in the **Cropping Window**, move the Positioner to the frame you want displayed, and click the **Grab Image** button.

To resize your cropping area, drag any of the resize handles. For example, drag the middle right handle to crop the right edge of your clip. To resize the entire cropping area at once, drag one of the corner handles (the corner that's diagonally opposite the handle you are moving will remain stationary).

Once you've cropped your image, you can drag the entire cropping area in the **Cropping Window** to select a different area of your clip. You'll notice that the **Preview Window** displays your changes as you resize or drag the cropping area.

Using the crop controls

The controls under **Crop Settings** let you crop any edge of your effect. You can enter the values you want in the text boxes or drag the appropriate sliders (**Left**, **Right**, **Top**, **Bottom**):

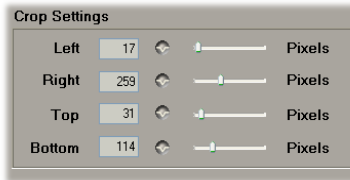

Using the Crop menu

You can also crop your effect using commands from the **Crop** menu, located below the **Cropping Window**:

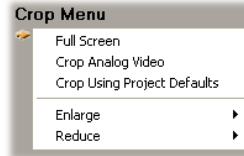

- **Full Screen** Sets your effect to full-screen size (that is, no cropping is done to the image).
- **Crop Analog Video** Crops the thin black borders that appear along the edges of video that's been captured from an analog source. These borders typically appear at the right and bottom edges of your image.
- **Crop Using Project Defaults** Re-applies the default cropping values you defined for your project (that is, your General settings in Adobe Premiere, as explained on [page 52](#)).
- **Enlarge** Lets you enlarge the visible area of your image by decreasing the cropping on all edges by a given percentage.
- **Reduce** Lets you reduce the visible area of your image by increasing the cropping on all edges by a given percentage.

Cropping an effect using the Preview Window

In the **Preview Window**, you can use your left and right mouse buttons to crop any edge of your effect:



The following table shows the available mouse controls for cropping in the **Preview Window**.

Action	Result
Left mouse button, drag up or down	Adjusts the top edge
Left mouse button, drag left or right	Adjusts the left edge
Right mouse button, drag up or down	Adjusts the bottom edge
Right mouse button, drag left or right	Adjusts the right edge
Both mouse buttons	Moves the cropped image

You'll notice that the values will change for the crop controls as you drag the mouse in the **Preview Window**.

Working with keyframes

A *keyframe* is a frame at which you've defined one or more effect settings to take place in a clip. The settings start at the frame where you define them, and remain active on the clip until you define a later keyframe to turn off or change the settings. This allows you to control the occurrence and duration of your effect settings. By interpolating between keyframes, you create gradual transitions between different settings for an effect.



Note The following sections explain how to use the Matrox realtime plug-in to work with keyframes. Be aware that the Matrox effects do not support Adobe Premiere's keyframes that are applied on the Timeline.

In the following sections, we explain how to:

- Use the effect controls to work with keyframes.
- Perform basic operations such as creating, copying, cutting, and pasting keyframes.
- Interpolate between keyframes.

Using the keyframes controls

Several controls are provided at the bottom of the **Matrox Effect Setup** dialog box to let you work with and view the keyframes in your clip:

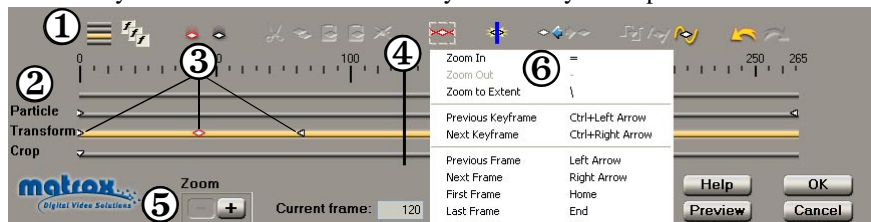

- ① **Toolbar** Provides buttons for the most commonly used keyframe tasks. Only buttons that can be used at a given time are available. When you hover your mouse pointer over an available Toolbar button, you'll see a tooltip describing the button.
- ② **Tracks and Ruler** The tracks represent the progression of your clip over time, with the Ruler above the tracks denoting your clip's frame numbers. Keyframes can be created on all tracks **except** the topmost track. You can click a track to switch to its corresponding page. For example, clicking the **Transform** track displays the **Transform** page.
- ③ **Keyframe symbols** Whenever you change an effect setting, a symbol such as appears on the appropriate track, representing the keyframe you've created. For example, in the preceding illustration, the symbol on the **Transform** track at frame 0 represents a transformation created at the

beginning of the clip. For more information, see [“Creating new keyframes”](#) on page 159.

- ④ **Positioner** You can use the Positioner to indicate where you want to create a keyframe. You can also preview an effect by dragging the Positioner as explained in [“Previewing your effects”](#) on page 88. To move the Positioner to a particular frame, enter the frame number in the **Current frame** box, or click the frame on the Ruler.
- ⑤ **Zoom buttons** You can zoom in or out to view keyframes by clicking the **Zoom** buttons. Depending on your zoom setting and the length of your clip, only a portion of your clip might be displayed inside the tracks. If this is the case, you can scroll forward or backward through the runoff portion of your clip by dragging the Positioner.
- ⑥ **Right-click pop-up menus** You can right-click any of the effect controls to display a context-sensitive pop-up menu. For example, if you right-click the Ruler, a pop-up menu appears that includes the **Zoom to Extent** command, which zooms your clip to fill the entire length of the tracks. Right-clicking the Positioner or the Ruler displays a pop-up menu that includes commands for moving the Positioner, such as **Snap**, which makes it easier to drag the Positioner onto a keyframe or vice versa.

For a complete list of shortcuts available for working with keyframes, see [“Keyboard shortcuts”](#) on page 166.

Creating new keyframes



To create a keyframe:

- 1 In the **Matrox Effect Setup** dialog box, click the tab or track where you want to create your keyframe.
 - 2 Move the Positioner to the frame in your clip where you want the settings to take place.
- Tip** Press the **HOME** key to move the Positioner to the first frame of your clip.
- 3 Use the effect controls in the dialog box to set up your effect. As soon as you adjust a control, a keyframe is created on the corresponding track, behind the Positioner:

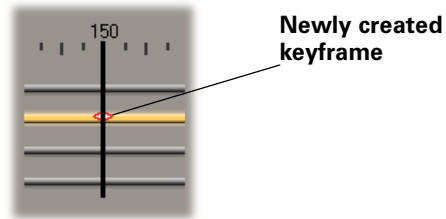

You can create a keyframe with default settings by pressing **CTRL+INSERT** or by clicking the **Apply Default Settings** button on the Toolbar. You can also create a keyframe with the currently displayed settings by pressing **INSERT** or by clicking the **Apply Current Settings** button on the Toolbar.

Modifying keyframes



To edit a keyframe:

- 1 Double-click the keyframe. The current settings for the keyframe are displayed on the page.
- 2 Edit the effect as needed. To apply default settings to the keyframe, press **CTRL+INSERT** or click the **Apply Default Settings** button on the Toolbar.

Resetting a track to default settings

To reset a track to its default settings, right-click the track and choose **Reset Track Data** from the pop-up menu. Resetting clears **all** keyframes from the track, including those that were pre-defined, and restores the default effect settings.



Note For those effects for which the **Simple edit** option is available, resetting the track to default settings replaces all keyframes on the track with a single keyframe.

Selecting keyframes

Many operations that you can perform on a keyframe, such as copying and deleting, require you to select the keyframe first. You can select keyframes using any of the following methods:

- Select a single keyframe by clicking it, or moving the Positioner to it when the track is highlighted.
- Select more than one keyframe by holding down the **CTRL** key while clicking the keyframes you want to select.
- Select a range of keyframes by clicking the first keyframe, then holding down the **SHIFT** key while clicking the last keyframe you want in the range.
- Select all keyframes on a track by:
 - clicking the **Select All** button on the Toolbar,
 - or pressing **CTRL+A** when the track is highlighted,
 - or by right-clicking the track and choosing **Select All**.

Copying and moving keyframes



To copy selected keyframes to a new location, do one of the following:

- Click the **Copy** button on the Toolbar, or press **CTRL+C**. Move the Positioner to the destination frame, then click the **Paste** button on the Toolbar, or press **CTRL+V**.
- Right-click the selection and choose **Copy** from the pop-up menu. Move the Positioner to the destination frame, then right-click the track and choose **Paste at Current Frame**.
- **CTRL+drag** the selected keyframes to a new location on the track.



To move selected keyframes, do one of the following:

- Click the **Cut** button on the Toolbar, or press **CTRL+X**. Move the Positioner to the destination frame (this frame can be in a different clip or for a different effect), then click the **Paste** button on the Toolbar, or press **CTRL+V**.
- Right-click the selection and choose **Cut** from the pop-up menu. Move the Positioner to the destination frame (this frame can be in a different clip or for a different effect), then right-click the track and choose **Paste at Current Frame**.
- Drag the selected keyframes to a new location on the track.

If a keyframe exists at your destination frame, it will be replaced with the pasted keyframe.



Note For details on how to paste only certain attributes of a keyframe, see the next section. You can also save all keyframes on a track to a file, then load the file to apply your settings to other clips. For details on how to do this, see [“Saving and loading keyframe files”](#) on page 162.

Pasting attributes of a keyframe (“selective paste”)

You can copy and paste some or all of the attributes of a single keyframe to selected keyframes. The attributes you choose to paste replace the corresponding attributes of the destination keyframes. This is called a “selective paste,” and is particularly useful when you want to make changes to a complex series of keyframes in a clip.

For example, let’s say you’ve created a series of **Transform** keyframes on a clip, where each keyframe uses all of the transform controls but with different **Size** settings. Your keyframe sequence might appear as follows:

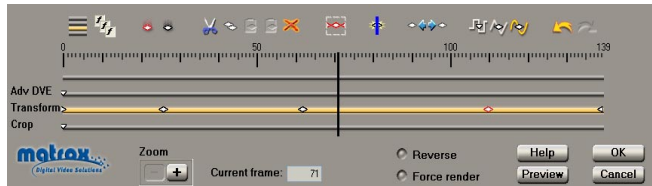

If you later decide that you’d like all the keyframes to have the same **Size** setting as the keyframe at frame 0, you could easily fix the sequence by pasting the initial keyframe’s **Size** onto the other keyframes as follows:

- 1 Click the keyframe containing the settings you want to paste. For this example, that would be the keyframe at frame 0 on the **Transform** track.
- 2 Click the **Copy** button on the Toolbar, or press **CTRL+C**.
- 3 Select the keyframes to which you want to paste the copied settings. You can **CTRL+click** individual keyframes to select them, or use **SHIFT+click** to select a range of keyframes.
- 4 Click the **Selective Paste** button on the Toolbar, or right-click any of the selected destination keyframes, then choose **Selective Paste** from the pop-up menu that appears. This displays a dialog box containing settings available for pasting, similar to the following:

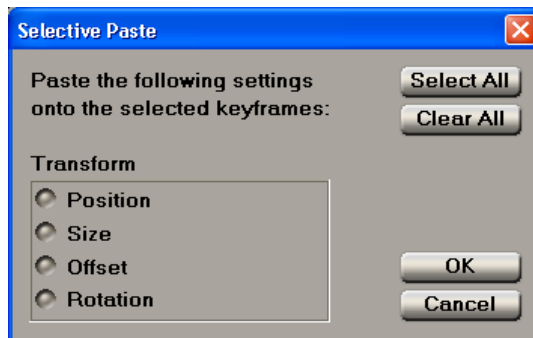



Note The dialog box that appears depends on what type of keyframe you're pasting.

- 5 Select the settings you want to paste. For this example, you would select only **Size**.
- 6 Click **OK**. Your destination keyframes are updated with the settings you selected, while retaining all other attributes.

Deleting keyframes



To delete a keyframe selection, use one of the following methods:

- Click the **Delete** button on the Toolbar.
- Press the **DELETE** key.
- Drag the selection vertically off the tracks.
- Right-click the selection and choose **Delete** or **Cut** from the pop-up menu.



Tip To delete all keyframes on a track, right-click the track and choose **Delete All** from the pop-up menu.

Saving and loading keyframe files

The **Save Keyframes** command lets you save all keyframes on a track to a file. You can then use the **Load Keyframes** command to load that file and apply the keyframes to other clips in your video production. This is useful for building a library of complex or frequently used keyframe sequences.

For example, after creating a complex series of keyframes to perform a 3D DVE tumble, you can save your keyframe sequence to a file, then load that file whenever you want to apply the same tumble to another clip in your project. You may also want to exchange your saved keyframes with other Matrox users. For details on how to save a customized Matrox effect and add it to your library of pre-created RT.X100 Xtreme effects, see "[Common controls on the Custom pages](#)" on page 87.



To save all keyframes on the currently selected track to a file:

- 1 Press **CTRL+S** or right-click the track and choose **Save Keyframes** from the pop-up menu.
- 2 In the provided dialog box, specify the file to which you want to store the keyframes. Your file will be given an extension that signifies the track name, such as *.Transform.Kft* if you're saving keyframes on the **Transform** track.



To load saved keyframes to the currently selected track:

- 1 Press **CTRL+O** or right-click the track and choose **Load Keyframes** from the pop-up menu.
- 2 In the provided dialog box, select the file you want to load. This file must contain keyframes belonging to the current track. For example, you can load

only transform keyframes to the **Transform** track, and load only crop settings to the **Crop** track.



Note Any keyframes presently on the track will be replaced by the loaded keyframes.

Interpolating between keyframes

Interpolating between two or more consecutive keyframes on the same track enables you to create a gradual transition from one keyframe's settings to the next.

In the following sections we explain:

- How interpolation works.
- Considerations for creating an interpolation sequence.
- Linear and spline interpolation.
- How to turn interpolation on and off.

How interpolation works

Interpolations are performed between different settings for an effect. For example, if you defined a size of 25% at the start of a clip and a size of 100% at the end of the clip, interpolating between the two keyframes makes your clip gradually increase in size from 25% up to full-screen size.

The speed of the transition between two consecutive keyframes depends on the amount of space (time) between them. For example, if you have a large amount of space between keyframes, the transition will occur slowly. Alternately, if your keyframes are close together, the transition will occur quickly.

Interpolation is supported for all of the Matrox effects for which you can create keyframes, except that you can't interpolate between:

- **Tile Patterns** and **Global Tile Settings** on the **Custom 3D Tiles** page.
- **Border Type** on the **Custom Advanced DVEs** page.
- **Preserve luminosity** and **Affect specific tonal range** on the **Custom Color Corrections** page.
- **Photo negative** on the **Custom Colorizations** page.
- **Invert key** on the **Custom Luma Keys** page.
- **Invert mask** on the **Custom Mask DVEs** page.
- **Type** on the **Custom Page Curls** page.
- **Global Effect Settings** on the **Custom Particles** page.

Considerations for creating an interpolation sequence

By default, a spline interpolation is set between consecutive keyframes created on the same track. For an explanation of spline interpolation, see the next section.

As you create new keyframes, each keyframe is initialized to the same settings as the one to the immediate left on the track. This makes it easy for you to define an interpolation sequence in ascending order (from left to right). If you add a new keyframe **between** two interpolated keyframes, however, the new keyframe's settings will be calculated according to the adjacent keyframes. For example, if you add a keyframe between a size setting of 0% and 50%, the size for the new keyframe will be set to 25%.



Note If you use the **Reverse** option for a Matrox effect, the interpolation sequence is defined from right to left.

Linear and spline interpolation

There are two types of interpolation that you can apply to a keyframe — linear or spline. Linear interpolation means that the transition between effect settings occurs in even, linear increments. For example, let's say you have two linearly interpolated keyframes 75 frames apart with **Size** settings of 0% and 75%, respectively. When you play back your clip, the size of your clip increases between these two keyframes at a steady rate of 1% per frame.

If you have three or more interpolated keyframes, linear interpolation might not give the results you want. Spline interpolation gives you a smoother transition based on the settings of **all** keyframes. For example, if you add a third keyframe (with **Size** at 100%) to the example given in the previous paragraph, the difference between linear and spline interpolation can be illustrated as follows:

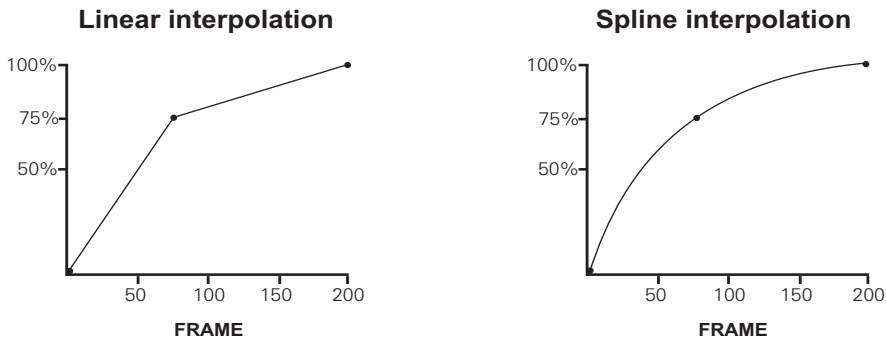

Notice how spline interpolation reduces the abruptness in the rate of interpolation between the keyframes. Spline interpolation is particularly useful for creating smooth transitions when you move a clip to different locations on the screen.

Creating keyframes outside the clip region

Because spline interpolation is affected by both the number of keyframes and the distance (frames) between them, you may find it helpful to create keyframes **outside** the clip region on the track. For example, you could start your

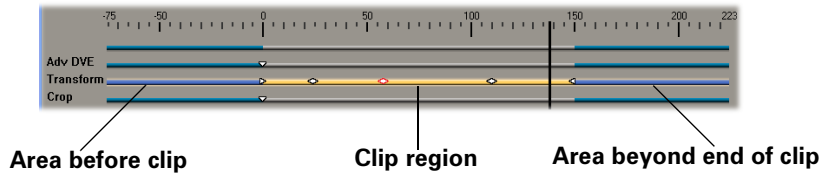

interpolation sequence several frames before your clip starts to make the spline calculations start earlier.

To display the area outside the clip region, right-click the track and turn off **Display Clip Region Only**. Then drag the Positioner forward or backward to scroll to the area outside the clip.







Turning interpolation on and off

As previously mentioned, a spline interpolation is set by default between consecutive keyframes created on a track. You may, of course, choose to turn off interpolation or change the interpolation type.

To turn off or reset interpolation, click the keyframe or a range of selected keyframes, then on the Toolbar, click  for no interpolation,  for linear interpolation, or  for spline interpolation. You can also right-click the keyframe or a range of selected keyframes, then choose **Interpolation Type > None, Linear, or Spline** from the pop-up menu.

Depending on the location of a keyframe in a sequence and whether or not interpolation is set, the keyframe will be represented as follows:



















-
-  First keyframe in an interpolation sequence.
 -  Intermediate keyframe in an interpolation sequence.
 -  Last keyframe in an interpolation sequence.
 -  Keyframe that is not in an interpolation sequence.
-



Note Newly created keyframes will be assigned the same interpolation setting as that of the keyframe to the immediate left on the track (or to the right if you use the **Reverse** option).

Keyboard shortcuts

The following table provides a complete list of keyboard shortcuts (and corresponding buttons, if available) that you can use when working with keyframes in the **Matrox Effect Setup** dialog box.

Command	Keyboard Shortcut	Button
Zoom In	= or F4	
Zoom Out	- or F3	
Zoom to Extent	\ or SHIFT+F3	
Select All	CTRL+A	
Cut	CTRL+X	
Copy	CTRL+C	
Paste at Current Frame	CTRL+V	
Selective Paste	CTRL+SHIFT+V	
Delete	DELETE	
Save Keyframes	CTRL+S	
Load Keyframes	CTRL+O	
Previous Keyframe	CTRL+LEFT ARROW or F5	
Next Keyframe	CTRL+RIGHT ARROW or F8	
Previous Frame	LEFT ARROW or F6	
Next Frame	RIGHT ARROW or F7	
First Frame	HOME or CTRL+F6	
Last Frame	END or CTRL+F7	
Snap	S	
Preview Entire Effect	ALT+SPACEBAR	
Preview from Positioner	SPACEBAR	
Toggle Track State	CTRL+F2	
Solo Mode	F2	
Apply Current Settings	INSERT	
Apply Default Settings	CTRL+INSERT	
Undo	CTRL+Z	
Redo	CTRL+Y	

Setting up realtime graphics overlays

You can add realtime alpha-keyed graphics layers to your production (such as to overlay a title onto a video clip). To do this, you create a single-frame graphics file using any graphics program that supports an alpha channel, such as Adobe Photoshop. You can use any graphics format that is supported by Adobe Premiere (such as *.tga* or *.icg*).

⇒ To set up your realtime graphics overlay:

- 1 Import the graphics file into your Adobe Premiere project.
- 2 Place the clip in your Timeline on a superimpose track (Video 2 or higher).

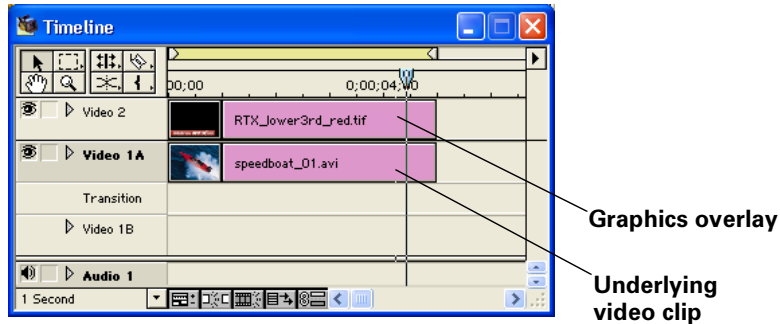

- 3 Right-click your clip on the superimpose track, then choose **Video Options > Transparency**.



Note Some graphics file formats (such as *.icg*) are automatically alpha-keyed when placed on Video 2 or higher.

- 4 In the **Transparency Settings** dialog box, choose **Alpha Channel** as the **Key type**, then click **OK** to return to your Timeline.

Remarks

- If needed, Premiere will resize your graphics to full screen resolution (720×480 for an NTSC image, or 720×576 for a PAL image). You can maintain your clip's aspect ratio by choosing **Clip > Video Options > Maintain Aspect Ratio**.
- You can change the duration of your graphics overlay by dragging its borders. For example, to make your graphics overlay the same length as your underlying video clip, drag its left or right border until your clip is the desired length. To change the default duration of your single-frame graphics overlays, choose **Edit > Preferences > General and Still Image**.

- You can add a realtime fade to your graphics overlay using Adobe Premiere's Video Opacity rubberband control, such as to fade-in and fade-out as shown below:

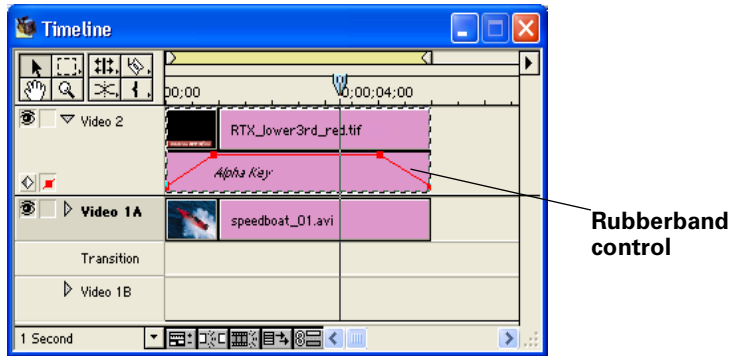

What is XtremePreview?

When XtremePreview is enabled in the **Matrox Advanced Settings** dialog box, as explained on [page 50](#), you'll be able to edit and preview numerous video and graphics layers without having to render. In many cases, you'll be able to preview all sources (including multiple Matrox effects in any order) for the segment you are editing, even if the segment requires rendering (that is, there is a red bar above the time ruler on the Premiere Timeline). In addition, with XtremePreview, many combinations of Matrox effects will remain realtime.

When playing back your project from the Timeline, segments that can't be previewed using XtremePreview appear as a "not yet rendered" (X) graphic.

Adaptive degradation

Certain complex effects or combinations of effects can cause dropped frames when previewing. In these cases, XtremePreview performs an adaptive degradation of the video playback by analyzing the segments and dropping frames systematically. With each subsequent playback, that is, every time you replay the clips during the same work session, the segment progressively becomes smoother.



Note Once playback of the Timeline has stopped, a red bar will appear over the segments that have dropped frames to indicate that these segments will require rendering to perform a Matrox realtime export to disk or export to DV tape. If you close your project before rendering, the red bar won't re-appear until you play your project again.

Automatic solo mode preview

In cases where it's not possible to preview all the sources for a segment, solo mode is automatically set once you enter the **Matrox Effect Setup** dialog box (that is, only the source for the effect you are editing is previewed). This can be caused by your segment having one or more of the following characteristics:

- Too many video or graphics layers.
- An unsupported clip setting (such as one of Premiere's field processing options) or a Premiere software effect or non-realtime transition.



Note To avoid automatic solo mode, you can choose to ignore unsupported clip settings or Premiere software effects when using XtremePreview, as explained on [page 53](#).

- More than four speed changes.
- More than one Matrox effect based on a pattern file (such as the Matrox particle effect).



Tip To see the segment with all applied effects, you can use the render-scrub feature (**ALT+drag** the Positioner) in the **Matrox Effect Setup** dialog box.

A/B mode preview

There are a few instances when you'll see an A/B representation of your Matrox effect in the **Matrox Effect Setup** dialog box. This is because the segment you're editing has one or more of the following characteristics:

- A graphics roll, crawl, or animation.
- A video standard that doesn't match your system.
- An unsupported video source (such as a QuickTime file).



Tip To see the segment with all applied effects, you can use the render-scrub feature (**ALT+drag** the Positioner) in the **Matrox Effect Setup** dialog box.

RT.X100 Xtreme realtime rules

In your Adobe Premiere projects, you can use various combinations of realtime Matrox RT.X CPU-based effects, hardware-accelerated effects, and Adobe Premiere realtime transitions, all with transparency.



Note Realtime means that you won't need to render the segment on the Timeline to perform a realtime export to disk or export to DV tape (that is, there is no red indicator bar above the segment). You'll still be able to preview many segments that require rendering, as explained in the previous section "[What is XtremePreview?](#)" on page 169.

The Matrox CPU-based effects are color corrections, chroma keys, luma keys, and speed changes applied to a clip. The CPU-based effects can be applied only to video clips in real time. The Matrox hardware-accelerated effects are all the other RT.X effects (such as page curls, particles, Premiere realtime transitions, and fades). The hardware-accelerated effects can be applied to video or graphics clips in real time.

This section explains the rules and guidelines you'll need to follow in order to keep your effects realtime, assuming that you're using a recommended system, as explained in "[System requirements](#)" on page 4.

Supported graphics formats

All single-frame graphics formats supported by Adobe Premiere are supported in real time on Matrox RT.X100 Xtreme. This includes all titling formats that Premiere supports, such as Adobe Title Designer *.pttl* files and Inscribe *.icg* files. For details on the supported formats, see your *Adobe Premiere User Guide*.



Note For Premiere to use titling formats such as *.icg*, you'll need to have the manufacturer's program installed on your Matrox RT.X100 Xtreme system. For example, *.icg* files require an Inscribe program, such as TitleExpress.

General rule

The general rule to follow to avoid the red indicator bar when setting up your realtime effects is that in any given segment, you can use up to two video clips (.avi files), and four single-frame graphics clips.

Each clip in the segment can have a fade applied to it. A fade can be any one of the following:

- A fade (video opacity) effect created using Premiere's Opacity rubberband.
- An Adobe Premiere Cross Dissolve.
- An Alpha Channel key applied to a graphics clip (with or without rubberbanding).

Combining effects

In any given segment, you can apply the following RT.X effects in real time:

- 2 color correction effects, and
- 1 chroma key or luma key effect, and
- 2 speed changes, and
- at least 1 Matrox hardware-accelerated effect (such as a page curl or a Premiere realtime transition). If XtremePreview is enabled, you may be able to combine more than 1 Matrox hardware-accelerated effect in your segment in real time, depending on the type and complexity of the effects (excluding Matrox effects based on pattern files).



Note Certain complex Matrox effects, such as particles, may not be realtime when applied to a segment containing multiple graphics clips.

Order of effects

The order in which you apply your RT.X effects is important when you combine effects. When applying multiple RT.X effects to a segment, follow this order:

- 1 Color correction effect(s).
- 2 Chroma key, luma key, or Matrox hardware-accelerated effect.

For example, you can apply a page curl to a color correction and not require rendering. If, however, you apply a color correction to a page curl, the clip will require rendering (unless you change the order of the effects).



Note If this order is not followed, you'll still be able to preview your segment when using XtremePreview.

To change the order of effects applied to a particular clip, you can drag and drop effects in Premiere's **Effect Controls** palette. In the following example, **Matrox**

Page Curls appears after **Matrox Color Corrections**. Therefore, the clip will remain realtime:

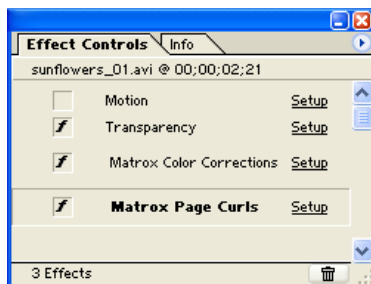

If you want to use Premiere’s virtual clip feature to combine RT.X effects, you must respect the following priority sequence when applying the effects:

- 1 Color correction effect(s).
- 2 Chroma key or luma key.
- 3 Matrox hardware-accelerated effect (such as a page curl, advanced DVE, or Premiere realtime transition).

For example, if your virtual clip includes a chroma key effect, you can apply a Matrox page curl effect to the clip and it won’t require rendering. If, however, you apply a chroma key effect to a virtual clip that includes a page curl effect, you’ll have to render the clip. For information on creating virtual clips, see your *Adobe Premiere User Guide*.

Restrictions

If you follow the rules listed above, your effects will remain realtime. You will, however, need to render your effects when you do any of the following:

- Select **Force render** when you set up an effect in the **Matrox Effect Setup** dialog box (see [page 86](#)).
- Perform a Matrox realtime export to disk or DV tape of a segment that has dropped frames.
- Place effects or clips too close on the Timeline, as explained in the section “[How to place your effects to avoid rendering](#)” on page 81.
- Use a graphics roll, crawl, or animation (only single-frame graphics are supported in real time).
- Apply a Matrox chroma key, luma key, or color correction to a graphics clip.
- Add a non-Matrox effect or transition, such as an Adobe Premiere video effect or non-realtime transition. For details on selecting which Adobe Premiere transitions you want to play back in real time, see “[Selecting your realtime effect settings](#)” on page 52.

- Apply an Adobe Premiere key type other than **None**, **Alpha Channel**, **Black Alpha Matte**, or **White Alpha Matte**.
- Apply any field processing options to a clip, such as **Always deinterlace** or **Flicker Removal**.
- Apply a freeze-frame effect to a clip using the **Frame Hold** command with the **Deinterlace** option selected (rendering won't be required if you clear the **Deinterlace** option).



Note When you play back the Timeline, non-realtime segments display as a “not yet rendered” (X) graphic.

Monitoring your CPU usage

Even on a system that meets the recommended system requirements, you can experience dropped frames when playing back certain complex realtime effects (such as particles and blurs), or combinations of effects. This is because of the high demand these effects place on your system's CPU.

You can monitor your CPU usage by right-clicking on the Windows taskbar, and choosing **Task Manager**. On the **Performance** tab, choose **Options** and make sure that **Always On Top** is selected. While playing back a segment of the Timeline, if your CPU usage reaches and maintains 100% for too long, you will drop frames.

You can use the **Force render** option to render your realtime effects without dropped frames (see [page 86](#)). Because some of the Matrox realtime effects are CPU-based, upgrading to a more powerful CPU might allow you to combine more of these effects.

Your notes

7

Using RT.X100 Xtreme with Video for Windows Programs

This chapter provides information you need to know when using Video for Windows programs to capture and render material on your RT.X100 Xtreme system.

Overview

When using Video for Windows programs to render (compile) material to an *.avi* file, such as in the case of a completed video production or an animation, you can use a Matrox codec to create a Matrox *.avi* file. For example, you may want to render an animation to Matrox DV/DVCAM format so that you can record it onto DV tape. You could also use your Video for Windows program to render video to a Matrox *.avi* file so that you can import the file as a realtime clip into your Adobe Premiere projects on Matrox RT.X100 Xtreme.

Your Matrox RT.X100 Xtreme hardware also allows you to use your Video for Windows program to capture analog video. The Matrox realtime plug-in for Adobe Premiere lets you capture analog and DV clips. You can, however, capture analog clips using capture programs other than Adobe Premiere, such as Sonic Foundry's Vegas Video. You can also use many messenger and video conferencing programs (such as Microsoft NetMeeting) to send streaming video over the internet or your corporate intranet.

The following sections explain the various settings you need to make to render and capture material using a Video for Windows program with your Matrox RT.X100 Xtreme system. For details on exporting video from Adobe Premiere to a Matrox *.avi* file, see [“Performing a Premiere export to disk”](#) on page 64. Using Adobe Premiere to export video on your Matrox RT.X100 Xtreme system lets you overcome the 2-GB *.avi* file limit of Video for Windows programs.

Remarks

- Be aware that *.avi* files do not have an alpha-key channel for storing transparency information. If you want to render an animation containing transparency information so that it can be alpha-keyed using your nonlinear editing program, you should render the animation to a series of *.tga* files, **not** to an *.avi* file. You can import a *.tga* sequence into Adobe Premiere and alpha-key the sequence after placing it onto a superimpose track, but your sequence will **not** play back in real time. If you render a single-frame *.tga* file with an alpha-key channel, however, you can set up a realtime graphics overlay in Adobe Premiere as explained in the section [“Setting up realtime graphics overlays”](#) on page 167.
- Instead of using your Video for Windows program to capture analog clips on your Matrox RT.X100 Xtreme system, you'll get much better results using a Matrox capture format in Adobe Premiere to capture your analog clips.
- Although Matrox has tested many Video for Windows programs, there may be certain operational limitations when using Matrox RT.X100 Xtreme with some of these programs (as well as with untested programs).

Using VFW programs without the RT.X100 Xtreme hardware

If you installed the Matrox Video for Windows (VFW) software codecs (see [“Installing the Matrox VFW software codecs on a system without the RT.X100 Xtreme hardware”](#) on page 37), you can render and play back RT.X100-compatible *.avi* files using your Video for Windows program without having the RT.X100 Xtreme hardware in your computer. To capture material, however, your system must be equipped with the RT.X100 Xtreme hardware.

Before you start rendering

Before you start rendering material to a Matrox *.avi* file, make the following settings in your Video for Windows program:

- Set the frame rate for rendered material to 29.97 frames per second for NTSC video, or 25 frames per second for PAL video.
- Set the frame size of your rendered material to full-screen: 720×480 for NTSC video, or 720×576 for PAL video.
- To render a video production at a quality that’s different from the one at which your clips were created, all your clips must be recompressed at the new quality level during the rendering process. If your program provides an option for controlling compression, set this option to **Always recompress** when rendering.
- For best results, make sure you clear your program’s **Data rate limit** option for rendered material. This ensures that your *.avi* files will be rendered at the particular video quality you select.
- If you’re using Adobe Premiere, set the **Fields** for rendering to **Lower Field First** for NTSC video, or **Upper Field First** for PAL video.



Note Before rendering a lot of material, check that your rendered animations and transitions such as wipes and slides play back smoothly. If they appear jumpy, try adjusting the field dominance or field order for your rendered material. For example, if your transitions appear jumpy with the field dominance set to **Odd field** or **Field 1**, try switching the setting to **Even field** or **Field 2**.

Selecting color space conversion options

When you render material to an *.avi* file using a Matrox VFW codec, you can determine how you want the luminance levels and chroma information to be processed during the color space conversion that's performed during the render.



Note The default settings for color space conversion provide good results for most applications. We recommend that you change these settings only when needed for special purposes.



To select the color space conversion options you want:

- 1 If you're using Windows XP, do the following:
 - a Right-click **My Computer**, then choose **Properties > Hardware > Device Manager**.
 - b Under **Sound, video and game controllers**, double-click **Video Codecs**.
 - c Click **Properties**, then select **Matrox Codecs**.
 - d Click **Properties**, and then **Settings**.
- 2 If you're using Windows 2000, do the following:
 - a Choose **Start > Settings > Control Panel > Sounds and Multimedia**.
 - b Click the **Hardware** tab. Under the list of devices, select **Video Codecs**.
 - c Click **Properties**, then the **Properties** tab, and select **Matrox Codecs**.
 - d Click **Properties**, and then **Settings**.
- 3 In the provided dialog box under **Color Space Conversion**, select the options you want:

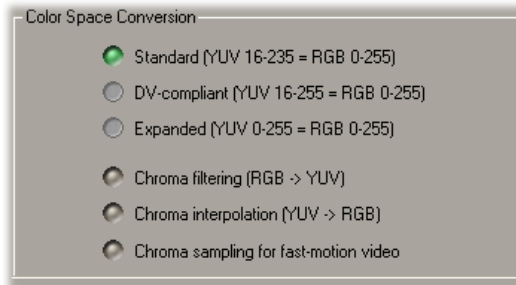

- **Standard** Renders video using standard broadcast luminance levels. Super black and super white luminance levels are clipped.
- **DV-compliant** Renders video using luminance levels appropriate for DV material. This ensures that the super white luminance levels of your video are retained.
- **Expanded** Renders video using the full range of luminance levels. Super black and super white luminance levels are retained. You may want to use

this setting, for example, to render material on which you'll be applying luminance key effects.

 **Important** When rendering RGB graphics, selecting **Expanded** or **DV-compliant** will create super black and/or white in your rendered images. For example, if you select **Expanded**, all black in your RGB graphics will become super black, and white will become super white. To render your RGB graphics with standard black and white levels, set your luminance range to **Standard**.

- **Chroma filtering** and **Chroma interpolation** Select these options to adjust the chroma bandwidth of RGB graphics. This improves images that have abrupt changes between different colors, such as a blue box on a black or white background. You should select these options for most animation and compositing work (computer-generated material). For most video editing programs, however, it's best that you **not** select these options. If you find that your rendered images appear to be blurred, try clearing one or both of these options.
- **Chroma sampling for fast-motion video** Select this option to help eliminate artifacts such as jagged edges and unwanted lines at the edges of fast-motion video (for PAL video only).

 **Important** When rendering graphics and titles, make sure that **Chroma sampling for fast-motion video** is **not** selected, as this option can cause jagged edges to appear in your rendered images.

- 4 Click **OK** to save your settings. Any change you make to your selected luminance range setting (such as switching from **Standard** to **Expanded**) will only take effect the next time you start your VFW program.

Rendering material to a Matrox VFW .avi file

When you render material to an *.avi* file, such as when you render a finished video production or an animation, you must select the compressor (codec) you want to create the file. The compressor determines the quality of your rendered video. Refer to your program's documentation for instructions on how to select a compressor for your *.avi* file.

To create a Matrox Video for Windows *.avi* file, select the **Matrox DV/DVCAM** codec from your program's list of available compressors.



Note If you installed the Matrox VFW codecs on a system without the Matrox RT.X100 Xtreme hardware, additional Matrox codecs will be available, such as the Matrox DVCPRO and Matrox MPEG-2 I-frame codecs. These codecs can be used to create clips for other Matrox systems, such as DigiSuite or RT2500. Matrox RT.X100 Xtreme supports DV/DVCAM clips only.

Before you start capturing

To properly capture and play back audio, make sure you've set appropriate recording and playback volume levels for your sound card, as explained in the section "4. Configure your sound card" on page 13.

If you want to create RT. X100-compatible .avi files (such as to use in your Adobe Premiere projects), make the following settings in your Video for Windows program before you start capturing:

- Set the frame rate for your captured clips up to 29.97 frames per second on an NTSC system, or up to 25 frames per second on a PAL system.
- For the best results, set the audio sampling rate to 44.1 or 48 kHz, and the sample size to 16-bit (mono or stereo). If you'll be capturing digital audio (AES/EBU or S/PDIF), make sure you set the audio sampling rate to the same rate as the digital input. For example, to capture audio from a CD player, set the sampling rate to 44.1 kHz.



Note The Matrox VFW capture driver does not support running more than one Video for Windows program at a time.

Capturing material for your production

The following sections explain how to select the device from which you want to capture material, change the proc amp settings of your incoming video, and select your video capture format and resolution.



Important Depending on which Video for Windows program you use, you may not have access to all of the following settings. Some Video for Windows programs may also override your settings with defaults needed for proper use of the program. For instructions on a program's use, such as how to capture material, refer to your program's documentation.

Selecting your capture source and adjusting proc amp settings

- 1 Start your Video for Windows program.
- 2 Choose the program's **Video Source** command (refer to your program's documentation).

- 3 From the list of available devices, select **Matrox Video Capture Device**. The **Matrox Input Source Settings** dialog box appears:

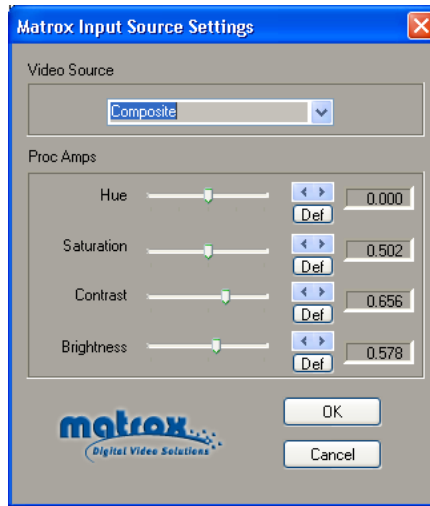

- 4 From the **Video Source** list, select **Composite** or **S-Video (Y/C)**. Make sure this setting matches your input device.
- 5 Use the proc amp controls as needed to adjust the incoming analog video signal before starting the capture. To return a control to its factory default setting, click the **Def** button.
- **Hue** Adjusts the tint of the colors in the image.
 - **Saturation** Adjusts the saturation (vividness) of the image's colors.
 - **Contrast** Adjusts the difference in luminance between the lightest and darkest areas of the image.
 - **Brightness** Adjusts the level of black in the image.

Selecting your capture format and resolution

- 1 Choose your program's **Video Format** command. The **Matrox Capture Format Settings** dialog box appears:

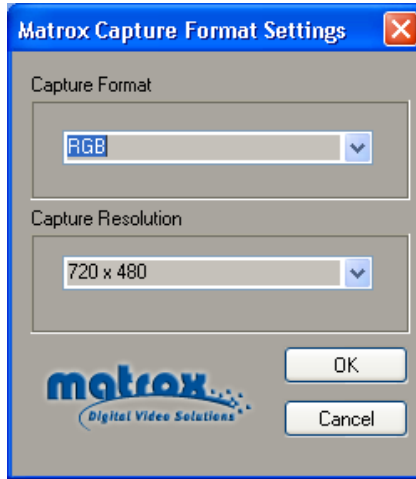

- 2 From the **Capture Format** list, select the format you want for your captured clips. To create an RT.X100-compatible *.avi* file, select DV/DVCAM.



Note In some Video for Windows programs, if you select **RGB** or **YUV** as your capture format, you'll have to choose a compressor from the list supplied by your program. For details, see your program's documentation.

- 3 If you select **RGB** as your capture format, you can select a different resolution from the **Capture Resolution** list.



Note The only **Capture Resolution** available for the **YUV** and **DV/DVCAM** capture formats is full-screen (that is, 720×480 for NTSC and 720×576 for PAL). Some Video for Windows programs, however, may only allow certain resolutions for proper usage, or may set a default resolution that overrides the selected capture resolution.



Tip If you're experiencing dropped frames during your captures, you can disable the program's live video window on your computer monitor (if allowed by the program) to try to solve this problem. If you have an NTSC or PAL video monitor connected to your system, you'll still be able to monitor your captures. Refer to your program's documentation for information on disabling the live video window.

A note about capturing video with audio

Because of the way Video for Windows captures material, when you capture video and audio to the same *.avi* file, the duration of the video and audio portions of the clip may not be exactly the same. For example, the clip's audio may end a few frames before its associated video. To play back the clip, Video for Windows adjusts the frame rate of the video so that it's synchronized to start and stop at the same time as the audio. This means the video may not play back smoothly, and the clip's frame rate won't match the standard frame rate for your system (29.97 fps for NTSC video, or 25 fps for PAL video). The problem is most apparent with very short clips.

If you use Adobe Premiere to capture your material, the duration of the video and audio portions of your clips will match.

Your notes

8

Using Matrox MediaTools

This chapter explains how to use Matrox MediaTools to scan and capture clips from your DV-1394 device, create a batch capture list, grab single-frame images, and export clips to an Adobe Premiere project.

About Matrox MediaTools

Matrox MediaTools is a DV capture application that allows you to perform automatic, unattended DV tape scanning and batch capture. With MediaTools, you can:

- In a single pass, automatically scan and capture clips from a DV tape into *.avi* files on your computer.
- Automatically scan an entire DV tape to create a batch capture list.
- Capture clips from a batch capture list at a later time, and adjust the In and Out points of clips prior to capturing.
- Capture live video from your DV-1394 device.
- Use onscreen transport controls to navigate quickly and easily through clips on tape or clips on disk.
- Grab single-frame images and save them as *.tga* or *.avi* files, such as to create photo montages.
- Edit the In and Out points of clips and recapture them.
- Change the order of clips in your clip list by simply dragging and dropping clips into the sequence you want.
- Export your clip list to an Adobe Premiere project where you can add Matrox realtime effects.



Note Your clips are captured in native DV format (that is, Matrox DV/DVCAM format).

Preparing your tapes for use with MediaTools

The tapes you use with MediaTools must contain continuous and consecutive time code, and all material must be recorded at the same speed. Leaving blank gaps between recorded material results in discontinuous time code. To avoid this problem, stripe your entire tape with time code before recording your source material. You can stripe your entire tape by recording black video for the duration of the tape. To do this, insert a blank tape into your camcorder, put the lens cap on, then record up to the end of the tape.



Note MediaTools requires about six seconds of preroll before capturing material. Therefore, don't record material that you want to capture within the first six seconds of your DV tape.

Starting Matrox MediaTools

Before you start Matrox MediaTools, make sure that your DV-1394 device is:

- Properly connected and turned on.
- Set to VTR mode to capture from tape, or Camera mode to capture live video.
- Loaded with a striped tape. To avoid problems, make sure your tape is **not** at the end.



Tip If you want to capture live video, make sure that the cassette compartment is empty to avoid possible auto-shutdown of the camera. For information on how to capture live video, see [“Capturing live video”](#) on page 197.



To start Matrox MediaTools:

- 1 Close any program you have running that uses your Matrox RT.X100 Xtreme, such as Adobe Premiere.
- 2 Choose **Start > Programs > Matrox X.tools > Matrox MediaTools**.



Note The first time you start MediaTools, the **Options** dialog box will be displayed. You can choose to display this dialog box each time you start MediaTools. For information on the **Options** dialog box, see [“Defining your capture settings”](#) on page 194.

- 3 To close the **Options** dialog box and start working with MediaTools, click **OK**.

Using the Matrox MediaTools interface

When you start MediaTools, a dialog box similar to the following appears:

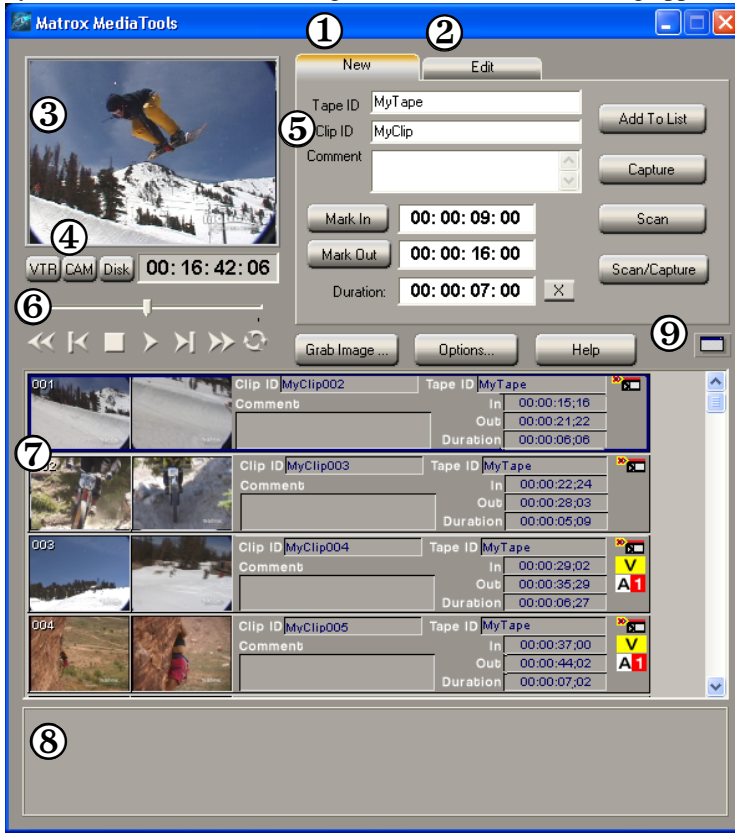

Here's a brief description of the **MediaTools** dialog box:

- ① **New tab** Use this tab to scan and capture new clips to add to your clip list, and create batch capture lists. For more information, see [“Scanning and capturing clips”](#) on page 196.
- ② **Edit tab** Use this tab to capture clips in a batch capture list, edit and recapture clips, and update clip information. For details, see [“Capturing clips from a batch capture list”](#) on page 200 and [“Editing clips”](#) on page 200.
- ③ **Preview Window** Allows you to preview clips on tape or clips on disk. Your clips are also displayed on your NTSC or PAL video monitor.
- ④ **VTR, CAM, and Disk buttons** These buttons let you switch between the following modes:

- **VTR** mode lets you control your DV-1394 device to capture and play back clips on tape.
 - **CAM** mode lets you capture live video from your DV-1394 device.
 - **Disk** mode lets you play back captured clips in your clip list.
- ⑤ **Clip identification area** This section contains several items to help you identify your clips.
- **Tape ID** Displays the name that you've assigned to the DV tape in your DV-1394 device.
 - **Clip ID** Displays the base name for your new clips when using the **New** tab, or the name of the currently selected clip when using the **Edit** tab. For details, see [“How MediaTools assigns clip names”](#) on page 196.
 - **Comment** Lets you enter comments that help you distinguish between clips in your clip list.
- ⑥ **Transport controls** A set of common transport controls that lets you easily navigate through clips on tape and clips on disk. For more information, see [“Navigating through clips with the transport controls”](#) on page 190.
- ⑦ **Clip list** A numbered list of clips and their properties. As you scan or capture clips in MediaTools, your clips are automatically added to the clip list. The clip list can be docked to the **MediaTools** dialog box or float freely as a resizable window. For more information on using the clip list, see [“Working with the clip list”](#) on page 201.
- ⑧ **Status bar** Displays information about the operation you're currently performing in MediaTools, such as clip information during a scan or capture.
- ⑨ **Float/dock clip list button** This button lets you dock the clip list to the **MediaTools** dialog box, or detach the clip list so that you can move and resize it. For more information, see [“Detaching and resizing the clip list”](#) on page 203.

Using the MediaTools pop-up menu

When you right-click anywhere in the clip list, a pop-up menu appears containing commands for working with MediaTools. All commands present in the MediaTools pop-up menu are described in this chapter.

Navigating through clips with the transport controls

MediaTools includes a common set of transport controls for navigating through clips on tape and clips on disk. You indicate the type of material you wish to control by selecting **VTR** or **Disk**. In **VTR** mode, the transport controls are used to navigate through clips on your DV tape. In **Disk** mode, the transport controls are used to control playback of clips from your hard drive (that is, .avi files for clips in your clip list).



Note The transport controls are disabled in **CAM** mode. The transport controls are much like those on your VTR:



Most of these controls perform standard transport functions, but some can be used for special tasks:



- **Shuttle/seek** Drag the slider on the **Positioner** to shuttle through your tape or any clip in your clip list.
- **Cue to In or Out point on disk** Click the **Rewind** or **Fast Forward** button to cue to the beginning or end of a clip on disk. Press **SHIFT+Mark In/Out** to cue to the In or Out point of a clip.
- **View frame-by-frame** Click the **Frame Reverse** or **Frame Advance** button.
- **Play a clip on disk repeatedly** Click the **Loop** button, then click the **Play** button.



Tip You can play back selected clips by right-clicking the clip list and choosing **Play From Tape** or **Play From Disk** from the pop-up menu. If multiple clips are selected in the clip list, the clips play back according to their assigned number (order) in the clip list. You can also play back any captured clip by double-clicking the clip in the clip list.

Keyboard Shortcuts		
CMX-style		Premiere-style
K	Disk mode	D
L	VTR mode	V
B	Play	L or SPACEBAR
Z	Rewind	R
X	Fast Forward	F
' (apostrophe)	Frame Advance	right arrow or 2
; (semicolon)	Frame Reverse	left arrow or 1
V	Stop	S or K
A	Loop	A



Note To select the style of keyboard shortcuts you want to use, click the **Options** button in the **MediaTools** dialog box, then select the option you want under **Transport Control Shortcuts**.

Using the time code fields

The time code fields display the In and Out points and duration of your clips.

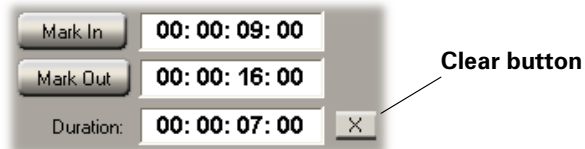

The following sections describe how to:

- Mark In and Out points.
- Edit the time code fields.
- Change the time code fields' format.

Marking In and Out points

To define a clip's In and Out points, you can either mark them as explained in this section, or you can type the In and Out points directly into the time code fields as explained in the next section.

To mark the In and Out points of your clip, do one of the following:

- Play your material and click the **Mark In** or **Mark Out** button when you see the frame where you want your clip to start or end, respectively.

- For increased precision, stop your clip at the appropriate frame and click the **Mark In** or **Mark Out** button.

You can cue to your In or Out point on tape by **SHIFT+clicking** the **Mark In** or **Mark Out** button.

Keyboard shortcuts		
CMX-style		Premiere-style
M	Mark In	I
, (comma)	Mark Out	O
SHIFT+Mark In	Cue In	SHIFT+Mark In
SHIFT+Mark Out	Cue Out	SHIFT+Mark Out

Editing the time code fields

When you type a time code in an empty or highlighted time code field, the numbers fill each section sequentially from right to left (frames, seconds, minutes, and hours), and separators are placed for you between the sections.



If you enter a value that exceeds the two-digit limit for a section, the appropriate time code will be calculated when you press the **TAB** key. For example, if you type 9005 (90 seconds, five frames) and press **TAB**, it will be calculated as 00:01:30:05 (one minute, 30 seconds, five frames) on an NTSC system.

When at least two time code fields are defined, MediaTools automatically calculates the remaining field. For example, once you've defined the In and Out points for a clip, its duration will be calculated for you.



To clear all the time code fields, click the clear button.

Changing the time code display

A value in a time code field can be displayed and entered as a time code or a specific number of frames. The first time you run MediaTools, the fields display time codes. To toggle between the two formats, press **CTRL+SHIFT** while the insertion point (flashing vertical bar) is in any time code field.

For example, on an NTSC system, you could change a value of 24:04 (24 seconds, 4 frames) to 724 frames by pressing **CTRL+SHIFT**. You could then edit the field in frames and switch back to time codes again by pressing **CTRL+SHIFT**.

The time code format of your DV tape is indicated by the separator between the seconds and frames digits in the time code fields as follows:

- A semicolon (;) indicates drop frame.
- A colon (:) indicates non-drop frame.



Note MediaTools automatically detects the time code format on your DV tape. If MediaTools is unable to determine the format, you'll be prompted to select the format that matches the format on your DV tape.

Defining your capture settings

Before capturing clips with MediaTools, you need to specify various capture settings, such as the folder where you want MediaTools to store your captured clips.

⇒ **To define your capture settings for MediaTools:**

- 1 Click the **Options** button.

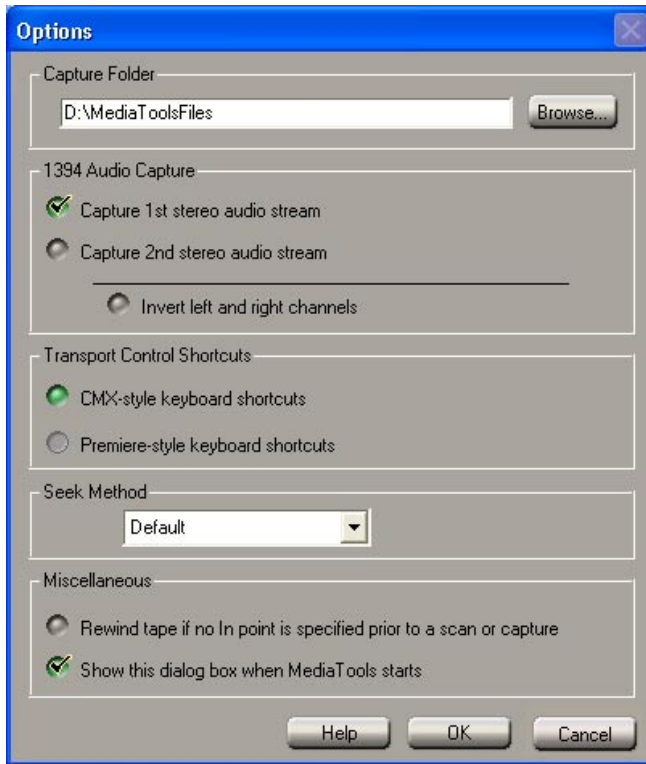

Note By default, the **Options** dialog box is configured to pop up every time MediaTools starts. To turn off this feature, clear **Show this dialog box when MediaTools starts**.

- 2 Under **Capture Folder**, specify the folder where you want to store your captured clips. For more information, see [“Selecting your capture folder”](#) on page 195.
- 3 Under **1394 Audio Capture**, select which DV stereo audio streams you want to capture. If you capture only one DV stereo stream, the audio stream of your stereo clip will be embedded in your *.avi* file, creating a single interleaved audio and video file. If you choose to capture both DV stereo

streams, the second audio stream will be saved to a separate audio file named *clipID_2ndStream.wav*.



Note When capturing audio over the 1394 interface with certain DV devices (such as Sony or Canon), the left and right channels may be inverted in the resulting *.wav* file. If this happens, you can select **Invert left and right channels** to correct the problem.

- 4 Under **Transport Control Shortcuts**, select which style of keyboard shortcuts you would like to use to navigate through clips on tape or clips on disk with the transport controls. For a list of available shortcuts, see [“Keyboard shortcuts”](#) on page 206.
- 5 Under **Seek Method**, if you’re having trouble controlling your DV-1394 device, select an alternate method to improve its performance. For example, if your DV-1394 device stops responding after performing a batch capture or cues incorrectly to an In/Out point on tape, you can experiment with alternate seek methods.



Note Most devices work best with the default seek method. If, however, an alternate seek method improves the performance of an RT.X-compatible DV-1394 device, this will be mentioned in the RT.X Support section of our web site.

- 6 Under **Miscellaneous**, you can select the option to rewind your DV tape if no In point is specified prior to starting a scan and capture. If you don’t select this option, MediaTools will start scanning and/or capturing from the tape’s current position.
- 7 Click **OK** to save your settings and return to the **MediaTools** dialog box.

Selecting your capture folder

You can select the folder where you want MediaTools to store your captured clips by typing the drive and folder name directly into the **Capture Folder** box, or by using the **Browse** button.



To ensure the best capture and playback performance of your clips, save them on one of your A/V drives.

MediaTools will save your video and audio clips in a subfolder with the same name as the **Tape ID**. For example, if you selected *D:\MediaTools* as your capture

folder, all video and audio clips from tape “MyTape” will be saved in *D:\MediaTools\MyTape*.

How MediaTools assigns clip names

When using the **New** tab, **Clip ID** displays the base name for your new clips. For example, if the **Clip ID** is “MyClip,” MediaTools will assign the name *MyClip000.avi* to the first new clip you capture, and continue naming clips sequentially (for example, *MyClip001.avi*, *MyClip002.avi*, etc.). Before scanning or capturing new clips, you can change the **Clip ID** to any base name you like.

When editing clips using the **Edit** tab, **Clip ID** displays the name of the selected clip in the clip list. You can change the name by typing a new name in the **Clip ID** box on the **Edit** tab, then clicking **Update**. You can also change a clip ID directly in the clip list by typing a new name in the clip’s **Clip ID** box, then pressing **ENTER**.



Note Changing the clip ID for a captured clip will **not** change the clip’s file name.

Scanning and capturing clips

With MediaTools, you can automatically scan and capture clips from a DV tape in a single pass. Scanning the tape identifies all the individual clips on your tape based on when the DV-1394 device started recording and when it stopped. You can also choose to capture live video from your DV-1394 device. Capturing saves the clips as *.avi* files on your computer’s hard drive, which you can later export to an Adobe Premiere project (see [“Exporting your clip list to an Adobe Premiere project”](#) on page 205).



To scan and capture clips from your DV tape:

- 1 In the **MediaTools** dialog box, click the **VTR** button.
- 2 In the **Tape ID** box, type a name for the tape presently loaded in your DV-1394 device. In the **Clip ID** box, type the base clip name you’d like to be assigned to your clips. For more information, see the previous section, [“How MediaTools assigns clip names.”](#)
- 3 Mark or type in the In and Out points to identify where you want the scan/capture to start and stop.





Note If you don’t set an In point, MediaTools will start scanning from the current tape position, or rewind your tape before starting the scan/capture if you selected that option in the **Options** dialog box.

- 4 Click **Scan/Capture**.
- 5 Each time the video sequence on the tape changes, the clip is captured and added to the clip list. Each clip also appears with time code information and an icon representing the first and last frames of the clip.

- To stop the scan/capture before the Out point is reached (or if you left the Out point blank), click the **Stop and Mark Out** button.



Note You can identify captured clips by the small video and audio icons ( ) in the clip list. If you captured both DV stereo streams, a second audio icon (A2) will appear in the clip list.

Capturing individual clips from tape



To capture individual clips from your DV tape:

- In the **MediaTools** dialog box, click the **VTR** button.
- In the **Tape ID** box, type a name for the tape presently loaded in your DV-1394 device. In the **Clip ID** box, type the base clip name you'd like to be assigned to your clip. For more information, see [“How MediaTools assigns clip names”](#) on page 196.
- Mark or type in the In and Out points of the clip you want to capture.



Note If you don't set an In point, MediaTools will start capturing from the current tape position, or rewind the tape before starting the capture if you selected that option in the **Options** dialog box.

- Click **Capture**.
- MediaTools will start capturing the clip. To stop the capture before the Out point is reached (or if you left the Out point blank), click the **Stop and Mark Out** button.
- Your captured clip is added to the clip list with time code information and an icon representing the first and last frames of the clip.

Capturing live video



To capture live video from your DV-1394 device:

- In the **MediaTools** dialog box, click the **CAM** button. To capture live video, your DV-1394 device must be set to Camera mode.



Note To avoid problems, turn off your device for a few seconds before switching modes on your DV-1394 device, and make sure that the cassette compartment of your device is empty to avoid possible auto-shutdown of the camera.

- In the **Clip ID** box, type the base clip name you'd like to be assigned to your clip. For more information, see [“How MediaTools assigns clip names”](#) on page 196.
- Type in a duration for the clip you want to capture.
- Click **Capture**.
- MediaTools will start capturing the clip. To stop the capture before the duration is reached, click the **Stop and Mark Out** button.

- 6 Your captured clip is added to the clip list with its duration and an icon representing the first and last frames of the clip.

Creating a batch capture list

A batch capture list is a list of clips with defined In and Out points for clips on tape that you have not yet captured. There are two ways to create a batch capture list with MediaTools. You can automatically scan your DV tape to create a batch capture list of clips on your tape, or you can specify the In and Out points of individual clips on tape, and add them to your clip list.

Scanning clips



To create a batch capture list of scanned clips from your DV tape:

- 1 In the **MediaTools** dialog box, click the **VTR** button.
- 2 In the **Tape ID** box, type a name for the tape presently loaded in your DV-1394 device. In the **Clip ID** box, type the base clip name you'd like to be assigned to your clips. For more information, see [“How MediaTools assigns clip names”](#) on page 196.
- 3 Mark or type in the In and Out points to identify where you want the scan to start and stop.



Note If you don't set an In point, MediaTools will start scanning from the current tape position, or rewind your tape before starting the scan if you selected that option in the **Options** dialog box.

- 4 Click **Scan**.
- 5 Each time the video sequence on the tape changes, the clip is added to the clip list with time code information and an icon representing the first and last frames of the clip.
- 6 To stop the scan before the Out point is reached (or if you left the Out point blank), click the **Stop and Mark Out** button.
- 7 If you want to save your batch capture list so that you can capture the clips at a later time, right-click the clip list and choose **Save As**. For more information on saving and loading clip lists, see [“Saving and loading a clip list”](#) on page 202.
- 8 When you're ready to capture your clips, see [“Capturing clips from a batch capture list”](#) on page 200.



Note “Scanned only” clips have only a small tape icon () in the clip list.

Adding clips to a batch capture list



To define individual clips that you want to add to your batch capture list:

- 1 In the **MediaTools** dialog box, click the **VTR** button.
- 2 In the **Tape ID** box, type a name for the tape presently loaded in your DV-1394 device. In the **Clip ID** box, type the base clip name you'd like to be assigned to your clips. For more information, see [“How MediaTools assigns clip names”](#) on page 196.
- 3 Use the transport controls to navigate through clips on tape in your DV-1394 device.
- 4 Specify the In and Out points for your clip using any of the following methods:
 - Mark or type in the In and Out points of your clip, then click **Add To List** to add the clip to your clip list.
 - Mark or type in the In point of your clip, then click **Add To List**. MediaTools will cue to the In point of the clip and begin playing the tape until you click **Stop and Mark Out**.
 - Mark or type in the Out point of your clip, rewind your tape to where you want your clip to start, then click **Add To List**. MediaTools will use the tape's current position as the In point.
- 5 Continue adding new clips until you've completed your batch capture list.
- 6 If you want to save your batch capture list so that you can capture the clips at a later time, right-click the clip list and choose **Save As**. For more information on saving and loading clip lists, see [“Saving and loading a clip list”](#) on page 202.
- 7 When you're ready to capture your clips, see the next section, [“Capturing clips from a batch capture list.”](#)

Capturing clips from a batch capture list



To capture clips from your batch capture list:

- 1 In the **MediaTools** dialog box, click the **VTR** button.
- 2 Click the **Edit** tab.
- 3 Select the clips you want to capture in the clip list. If you want to capture all your clips, right-click the clip list and choose **Select All**.
- 4 Click **Capture**.
- 5 If needed, you'll be prompted to load the appropriate tape in your DV-1394 device. MediaTools will start capturing the selected clips in the order in which they appear on the tape. All selected clips in the clip list will be captured unless you click **Stop and Mark Out** to stop the capture.

Editing clips

You can edit the In and Out points of a captured clip and recapture it. You can also update the **Clip ID** and **Comment** information for clips in your clip list.



Note You can only edit and recapture clips that you originally captured in MediaTools. You cannot, however, recapture clips captured using **CAM** mode.

Updating and recapturing clips



To edit and recapture a clip:

- 1 In the **MediaTools** dialog box, click the **VTR** button.
- 2 Select a captured clip that you want to edit in the clip list. MediaTools will automatically switch to the **Edit** tab.
- 3 Mark or type in new In and Out points, or a new clip duration.
- 4 To update the information in the time code fields, click **Update**. A warning message is displayed to warn you that changing the In and Out points of the clip requires the clip's files to be deleted from your hard drive. Click **Yes** to change the In and Out points of the clip.
- 5 To recapture the clip, click **Capture**.
- 6 If needed, you'll be prompted to load the appropriate tape in your DV-1394 device. MediaTools will cue to the In point of the clip and capture it.
- 7 To stop the capture before the Out point is reached (or if you left the Out point blank), click the **Stop and Mark Out** button.



Tip The **Update** button can also be used to update the **Clip ID** and the **Comment** by simply typing in the text boxes and clicking **Update**. For more information on the clip ID, see [“How MediaTools assigns clip names”](#) on page 196.

Changing a clip's In and Out icons

In and **Out** icons are the small icons representing the first and last frames of a clip in the clip list. These icons can be changed to better represent your clip.



⇒ **To change the In and Out icons of scanned or captured clips in the clip list:**

- 1 Use the transport controls to play back your clip in the **Preview Window** and on your NTSC or PAL video monitor.
- 2 When you see the frame you want for the **In** icon, click **Grab In Icon**. MediaTools automatically updates the icon.
- 3 When you see the frame you want for the **Out** icon, click **Grab Out Icon**.

Working with the clip list

The following sections explain how to add new clips to the clip list, save and load clip lists, copy, move and delete clips, and how to detach and resize the clip list.

Adding clips

You can add a clip or a series of clips (.avi files) to the clip list using any of the following methods:

- On the **New** tab, enter valid In and Out points in the time code fields, then click **Add To List**. For more information about this feature, see [“Adding clips to a batch capture list”](#) on page 199.
- Drag an .avi file from a file management program, such as Windows Explorer, to the clip list. If you're adding clips to an existing clip list, you can drag them to the bottom of the clip list, or place them in a specific position using the methods described in the section [“Moving clips”](#) on page 202.
- Right-click the clip list, then choose **Import Clip** from the pop-up menu (or double-click an empty area of the clip list). In the **Open** dialog box, select the .avi files you want to import, then click **Open**.

Saving and loading a clip list

To save a clip list, right-click the clip list. Choose **Save As** from the pop-up menu to save your current clip list as a *.dvl* file.

You can load a clip list (*.dvl*) using any of the following methods:

- Right-click the clip list. Choose **Open Clip List** or **Open Recent** to select a recently-opened clip list.
- Drag a *.dvl* file from a file management program, such as Windows Explorer, to the clip list.
- Double-click the *.dvl* file in Windows Explorer to start MediaTools and load the clip list. Make sure that MediaTools is **not** running when you do this.



Note If you load a *.dvl* file to a clip list that already contains clips, it will replace the current clip list.

Copying clips

You can copy a clip or a series of clips in the clip list using either of the following methods:

- Select the clips you want to copy, right-click the clip list, then choose **Copy** from the pop-up menu. Select a clip in the clip list, then choose **Paste** to paste the copied clips above the currently selected clip.
- Select the clips you want to copy, then **CTRL+drag** the clips and drop them into the sequence you want.



Note When copying a clip, the clip's *.avi* file is not copied, only the reference to the clip on tape is copied. MediaTools assigns the *-Copy* extension to the **Clip ID** of the copied clips.

Moving clips

You can change the order of clips in the clip list, such as to arrange clips in the order you want them to play back when using the **Play From Tape** or **Play From Disk** command. To rearrange your clips, do any of the following:

- Select the clips you want to move, then drag and drop them into the sequence you want. If you drag clips up in the clip list, the clips are inserted above the black line. If you drag clips down in the clip list, the clips are inserted below the black line. Releasing the mouse button places the clips in the list and ripples the position of all subsequent clips in the clip list.
- Select the clips you want to move, then right-click the clip list. Choose **Cut** from the pop-up menu to cut the clips. Select a clip in the clip list, then choose **Paste** to paste the clip above the currently selected clip.

Deleting clips

Select the clips you want to delete, right-click the clip list, then choose one of the following from the pop-up menu:

- To delete only the selected clips from the clip list, choose **Delete Clip Only**.
- To delete the selected clips and their corresponding files from your hard drive, choose **Delete Clip + File**.
- To delete only the files for the selected clips from your hard drive (the clips will remain in your clip list), choose **Delete File Only**.



Note When you choose to **Delete File Only**, MediaTools keeps the reference to the clip on tape in case you want to recapture the clip at a later time.

Keyboard shortcuts

Delete Clip Only	DELETE
Delete Clip + File	SHIFT+DELETE
Delete File Only	CTRL+DELETE

Detaching and resizing the clip list

You can change the size of your clip list to suit your needs. First, detach the clip list from the **MediaTools** dialog box by clicking the **Float/dock clip list** button () above the clip list. Now the clip list can be freely moved and resized. To resize the clip list, drag the sides or corner of the clip list as needed. You can also use the standard Windows **Maximize** and **Restore** buttons in the top right corner of the window.

After resizing, MediaTools will automatically rearrange the clips in the clip list. To dock the clip list back to the **MediaTools** dialog box, click the **Float/dock clip list** button, or click the **Close** button in the top right corner of the **Clip List** window. Once the window is docked again, MediaTools will remember the previous size and location of the clip list for the next time you detach the clip list.

Grabbing a single-frame image

You can grab single-frame (still) images and save them as *.tga* or *.avi* files to use in your Adobe Premiere projects. Your source video can be a clip on tape, a clip on disk, or live video.



Note If you save your image as an *.avi* file, it will be saved in DV/DVCAM format.



To grab a single-frame image:

- 1 If your source video is on tape or disk, use the transport controls to play back your DV tape, or double-click a captured clip in the clip list to play it back.
- 2 In the **MediaTools** dialog box, click the **Grab Image** button to open the **Grab Image** dialog box. Drag the **Grab Image** dialog box to the side so that it doesn't obscure the **Preview Window**.

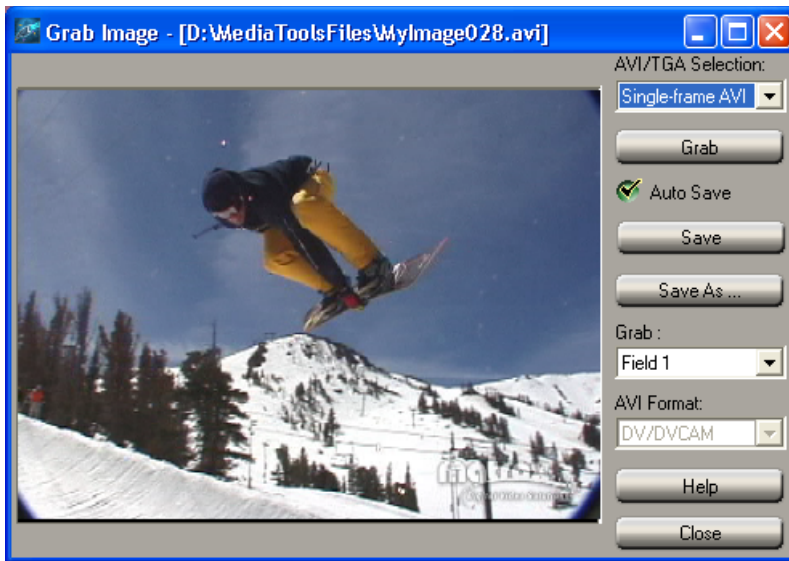

- 3 From the **AVI/TGA Selection** list, select **Single-frame AVI** or **TGA** to save your image as an *.avi* or *.tga* file.
- 4 When the frame you want is displayed in the **Preview Window**, click the **Grab** button.
- 5 If you notice flickering in your image, you can choose to grab only one of the fields. From the **Grab** list, select **Field 1** or **Field 2**. One field contains the odd-numbered scan lines in the frame, and the other field contains the even-numbered lines. Select the field that best displays your image. MediaTools interpolates between the two consecutive scan lines to create the missing field.
- 6 Click **Save** or **Save As** to save the image.



Note If you do not specify a file name in the **Save As** text box, or if you select **Auto Save**, MediaTools will assign a default name to the first grabbed image (such as *MyImage01.tga*, *MyImage01.avi*, or a name based on the last name you used) and continue naming images sequentially.

Keyboard shortcuts

Grab	F5
Auto Save	F6
Save	F7

Exporting your clip list to an Adobe Premiere project

You can export all or selected clips from the clip list directly to a new Adobe Premiere project (.ppj file).

- 1 Select the clips you want to export using **CTRL+click**, or select a range of clips using **SHIFT+click**.
- 2 Right-click the clip list. Choose **Export to Premiere** from the pop-up menu. A message is displayed asking if you want to export all clips in the clip list, or export selected clips. Choose **Export All** to export all clips, or choose **Export Selected** to export only selected clips.
- 3 In the **Save As** dialog box, enter the directory and file name for the project you want to export. Click **Save**.
- 4 Close MediaTools and start Adobe Premiere. You can now open the Adobe Premiere project you created and add Matrox realtime effects.

Keyboard shortcuts

The following tables provide a complete list of keyboard shortcuts available for using MediaTools.

Transport control keyboard shortcuts		
CMX-style		Premiere-style
K	Disk mode	D
L	VTR mode	V
B	Play	L or SPACEBAR
Z	Rewind	R
X	Fast Forward	F
' (apostrophe)	Frame Advance	right arrow or 2
; (semicolon)	Frame Reverse	left arrow or 1
V	Stop	S or K
A	Loop	A
M	Mark In	I
, (comma)	Mark Out	O
SHIFT+Mark In	Cue In	SHIFT+Mark In
SHIFT+Mark Out	Cue Out	SHIFT+Mark Out



Note To select the style of keyboard shortcuts you want to use, click the **Options** button in the **MediaTools** dialog box, then select the option you want under **Transport Control Shortcuts**.

Additional keyboard shortcuts	
CAM mode	C
Delete Clip Only	DELETE
Delete Clip + File	SHIFT+DELETE
Delete File Only	CTRL+DELETE
Grab	F5
Auto Save	F6
Save	F7
Import Clip	CTRL+I
Select All	CTRL+A
Cut	CTRL+X
Copy	CTRL+C
Paste	CTRL+V
New Clip List	CTRL+N
Open Clip List	CTRL+O
Save Clip List	CTRL+S
Export to Premiere	CTRL+E

Your notes

9

Using Matrox MediaExport

This chapter explains how to use Matrox MediaExport to export material from your Adobe Premiere Timeline to Windows Media, RealMedia, and MPEG formats.

About Matrox MediaExport

Matrox MediaExport is a plug-in for Adobe Premiere that brings together Windows Media and RealMedia streaming media, and Ligos MPEG encoding in one customizable export application. By taking advantage of your Matrox realtime editing hardware, MediaExport significantly reduces the rendering time of exporting clips from your Premiere Timeline. The MediaExport plug-in features:

- Accelerated video export from your Adobe Premiere Timeline to Windows Media, RealMedia, and Ligos encoders.
- Encoding of Windows Media, RealMedia, and MPEG video files in a single encoding session.
- Pre-configured streaming media encoding profiles.
- Pre-configured Ligos MPEG encoding profiles optimized for VideoCD and DVD-compliant video.
- Ability to customize any of the encoding profiles.
- Ability to save all settings of an encoding session to a file that can be loaded for a later session.

Starting the Matrox MediaExport plug-in

Matrox MediaExport is available when you use the **Export Timeline** command from within Adobe Premiere.



To start Matrox MediaExport:

- 1 Start Adobe Premiere.
- 2 Open the project from which you want to export material.
- 3 If you don't want to export all the clips in the project, drag the work area bar so that it covers the portion of your project you want to export.
- 4 Choose **File > Export Timeline > Matrox MediaExport**.

Overview of the Matrox MediaExport dialog box

When you start MediaExport, a dialog box similar to the following appears:

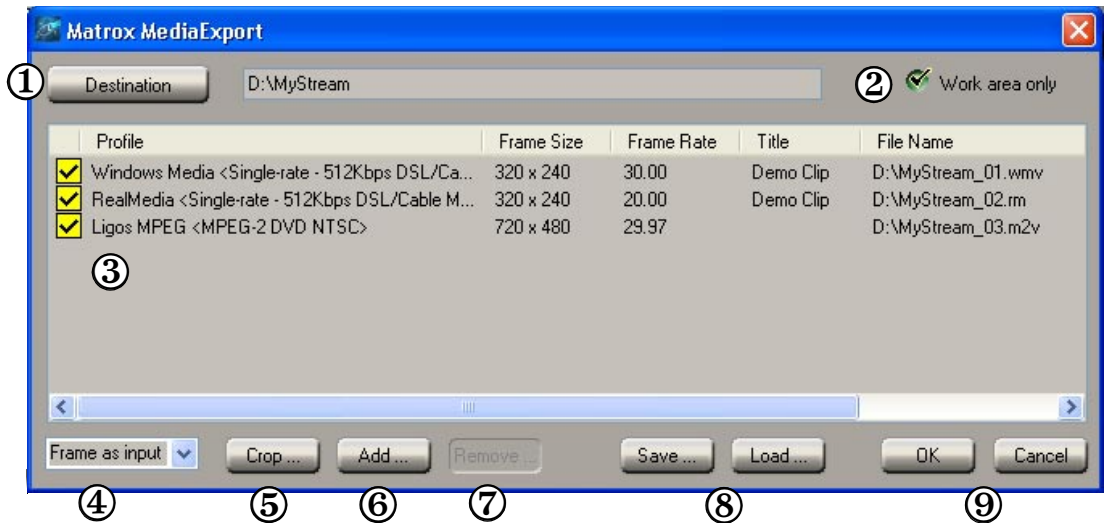

Here's a brief description of the **Matrox MediaExport** dialog box:

- ① **Destination** Lets you specify the destination folder for your encoded files and assign the base file name. For more information, see [“Exporting clips from the Timeline”](#) on page 212.
- ② **Work area only** Select this option if you want to export only the clips under the work area bar of your Adobe Premiere Timeline. For more information, see [“Exporting clips from the Timeline”](#) on page 212.
- ③ **Session window** Lists the encoding profiles that have been selected for use in the current encoding session. The columns show encoding settings for each profile. For more information, see [“Selecting encoding profiles for use in the session window”](#) on page 213.
- ④ **Input source** Lets you use either full frames or the first field of each frame as the input source for your encoded video. To achieve the best video quality, select **Frame as input**. However, if you crop your source video or output your video to non-standard frame sizes (frame sizes with heights that are not multiples of 480 for NTSC or 576 for PAL), the best video quality is achieved by selecting **Field as input**.
- ⑤ **Crop button** Opens the **Crop Source Video** dialog box where you can trim the edges of your source video. For more information, see [“Exporting clips from the Timeline”](#) on page 212.

- ⑥ **Add button** Lets you add an encoding profile to the session window. For more information, see [“Selecting encoding profiles for use in the session window”](#) on page 213.
- ⑦ **Remove button** Click this button to remove the currently selected profile from the session window.
- ⑧ **Save button** and **Load button** Click **Save** to save the current session as a *.mex* file that can be loaded in a later encoding session. Click **Load** to load a saved encoding session into the session window. For more information, see [“Saving and loading your encoding session”](#) on page 229.
- ⑨ **OK** and **Cancel buttons** Click **OK** to start encoding. Click **Cancel** to quit MediaExport and return to Adobe Premiere.

Using the MediaExport pop-up menu

When you right-click the session window, a pop-up menu appears containing commands for working with MediaExport. All commands present in the MediaExport pop-up menu are described in this chapter.

Exporting clips from the Timeline

This section explains how to export clips from your Adobe Premiere Timeline using MediaExport.

- 1 Start MediaExport as explained in [“Starting the Matrox MediaExport plugin”](#) on page 210.
 - 2 Click the **Destination** button, then specify the drive and folder where you want to store your encoded video files.
 - 3 In the file **Destination** box, enter the base name that you want to assign to the encoded files in this session. This base name will be assigned to the output files of all encoding profiles selected in the session window. To create a unique file name for each of your encoded files, MediaExport sequentially adds an underscore and a two-digit number to the specified base name. Regardless of what file types you encode in your session, each encoded file will be named using this convention (for example, *MyStream_01.wmv*, *MyStream_02.rm*, *MyStream_03.m2v*, etc.).
 - 4 To apply crop settings to your source video, click **Crop** and enter the crop values in pixels in the **Crop Source Video** dialog box. Your video will be cropped and then resized to the frame size specified for the encoding profiles you’ll be using.
- ① **Important** When you apply crop settings to your source video, the best quality video is achieved by selecting **Field as input** from the MediaExport dialog box. Your crop settings and input source selection apply to all the encoded files in the session.

- 5 To export only the clips under the work area bar of your Adobe Premiere Timeline, select **Work area only**.
 - 6 Click the **Add** button, then select the encoding format you want, such as **Windows Media**.
 - 7 From the profile library, select the encoding profiles you want to use. You can select many encoding profiles for a single encoding session. For details on selecting a standard profile, see [“Selecting encoding profiles and adding clip information”](#) on page 213. For details on creating a custom profile, see [“Modifying standard profile settings to create a customized profile”](#) on page 215.
-  **Tip** You can clear the check boxes for profiles you don't want to use for the current encoding session.
- 8 To start the encoding process, click **OK**. Once the encoding is complete, MediaExport closes automatically.

Selecting encoding profiles and adding clip information

The Matrox MediaExport plug-in for Adobe Premiere includes a number of standard encoding profiles with settings pre-configured for optimum delivery and playback of your video. For streaming media clips, such as Windows Media clips, you can add information about your video, such as its title and important copyright information.

The standard encoding profiles are listed in MediaExport's profile libraries. Standard encoding profiles cannot be removed from the profile libraries and their pre-configured settings cannot be permanently modified. Using standard profiles is the easiest and fastest way to encode your clips.

If your video clip or target audience requires encoding settings that differ from those of the standard profiles, the encoding settings can be modified for the current encoding session. If you want to permanently save modifications to an encoding profile's settings, you must create a customized encoding profile. For details on how to do this, see [“Modifying standard profile settings to create a customized profile”](#) on page 215.

Selecting encoding profiles for use in the session window

To encode video files, you must select at least one encoding profile from the profile library and add it to the session window. MediaExport allows you to add many encoding profiles to the session window at one time.

⇒ **To select an encoding profile:**

- 1 Click **Add** and choose an encoding format from the list. You can also right-click in the session window, then choose the format you want from the pop-up menu, such as **Add Windows Media**.

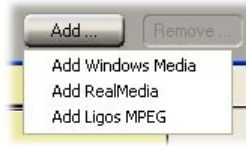

Note If an encoding format is not available from the list, it cannot be added to the current encoding session. This means that you've either added the total maximum number of profiles to the session window, or you've reached the limit for a specific encoding format.

- 2 Depending on the encoding format you chose, a **Profile Library** dialog box appears. From the list, select the encoding profile that you want to use. A brief description of the selected standard profile appears in the status box below the profile list.

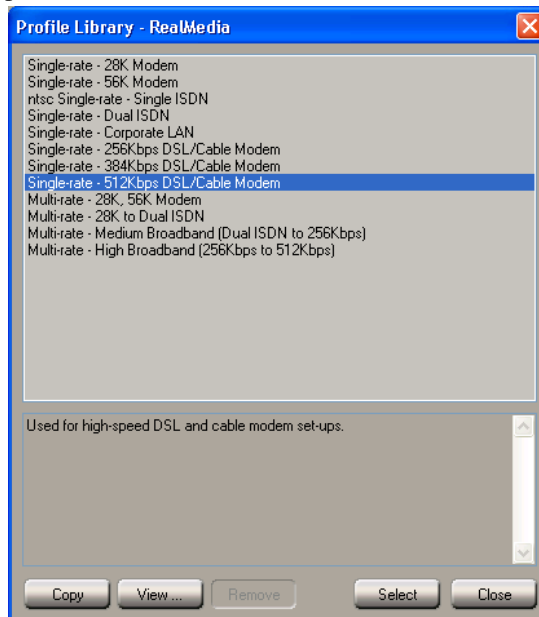

Note Before adding the selected profile to the session window, you can view the profile's default settings. Click the **View** button and browse through the tabs of the **Export Settings** dialog box. To modify any of the profile settings,

see [“Modifying standard profile settings to create a customized profile”](#) on page 215.

- 3 To add the selected encoding profile to the session window, click **Select**.

 **Tip** If you want to remove an encoding profile that you’ve added to the session window, select it, then either click the **Remove** button, or right-click in the session window and choose **Remove** from the pop-up menu.

Adding clip information to your streaming video

You can add information to your RealMedia or Windows Media file, such as its title, important copyright information, and the author’s name. This information will be displayed when your video clip is played in RealPlayer or in Windows Media Player.

To add clip information:

- 1 In the session window, do one of the following:
 - Double-click the profile to which you want to add clip information.
 - To apply the same clip information to more than one profile, **CTRL+click** or **SHIFT+click** to select multiple encoding profiles. Right-click any of the selected profiles, then choose **Settings** from the pop-up menu.
- 2 Click the **Clip Information** tab, then enter the clip information you want.

 **Tip** You can also add or modify the title of your video clip by typing it directly in the session window.

- 3 To return to the session window, click **OK**. To save your encoding session, see [“Saving and loading your encoding session”](#) on page 229.

Modifying standard profile settings to create a customized profile

By modifying the settings of standard encoding profiles, you can create customized encoding profiles that meet the specific needs of your media content, and optimize the delivery of your video to your intended audiences. Your customized profiles can be renamed and permanently added to the profile libraries. They are easily identified in the **Profile Library** dialog boxes by an * prefix.

To modify an encoding profile:

- 1 From one of MediaExport’s profile libraries, select the standard profile that you want to modify.
- 2 Do one of the following:
 - Click **Select** to add the selected profile to the session window. Double-click the profile, or right-click the profile and choose **Settings** from the pop-up menu. The changes you make will be retained only for the current encoding

Modifying standard profile settings to create a customized profile

session, unless you choose to save your customized profile as explained in the section [“Adding your customized profile to the profile library”](#) on page 228.

- Click **Copy** to add a copy of the selected profile to the profile library, then click the **Edit** button. The changes you make will be saved to the copy in the profile library.



Note You can use the **Remove** button to permanently delete profile copies or customized profiles from the profile libraries. You can't remove standard profiles.

- 3 Under **Profile Name**, enter a new profile name.
- 4 Under **Profile Comment**, enter any comments that you want to appear in the status box of the **Profile Library** dialog box.
- 5 Select the media type(s) that you want to include in your encoded file by selecting **Export video** and/or **Export audio**.
- 6 To specify the destination folder and base name for files encoded using the current encoding profile, either click **Output File** and browse to the folder you want, or enter a folder and base name under **Output File**. Changing the destination folder and base name associated with this profile will not affect the destination folder or base name for other profiles in the session window.



Tip You can also change the destination folder and base name associated with the profile by typing it directly in the session window under the **File Name** heading.

- 7 To add information about your RealMedia or Windows Media streaming video clip, click the **Clip Information** tab (see [“Adding clip information to your streaming video”](#) on page 215).
- 8 If you want to make advanced modifications to your customized encoding profile, such as to change the bit rate settings used and the desired frame size, see the next section, [“Fine-tuning your customized encoding profiles.”](#) If you want to add your customized profile to the profile library, see [“Adding your customized profile to the profile library”](#) on page 228.

Fine-tuning your customized encoding profiles

You can make advanced modifications to your customized encoding profiles, such as to change the video and audio options and bit rate settings. For your streaming videos, you can choose from a list of RealMedia or Windows Media video and audio codecs, frame sizes, and other options. For your Ligos MPEG videos, you can choose the MPEG format you want to use, modify the arrangement of the video's GOP (Group of Pictures) structure, and set the speed of the motion estimation algorithm.



Note For more information on RealMedia and Windows Media encoder settings, see the Advanced RealMedia and Advanced Windows Media plug-in online Help or PDF documentation in Adobe Premiere.

Selecting your RealMedia codec options

- 1 Click the **RealMedia** tab. By default, the **Codec Options** are displayed.

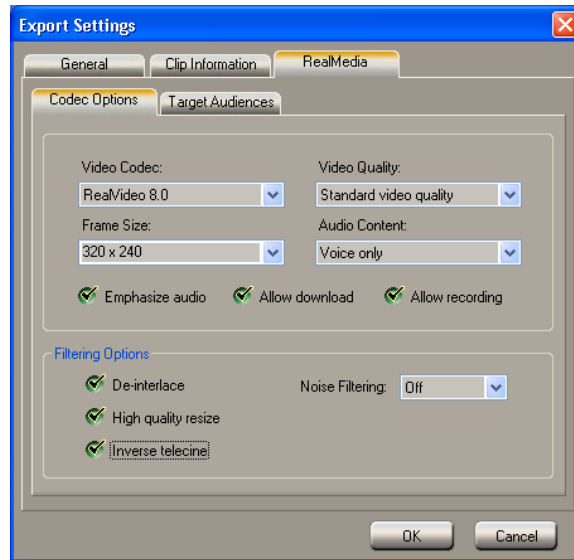

- 2 From the **Video Codec** list, select the video codec that you want to use. If you're encoding a high-action video clip for high-bandwidth Internet connections, you may want to select the latest version of the video codec.



Note When selecting a video codec for a RealMedia multiple bit rate profile, don't select the RealVideo codec because it does not support multiple bit rate encoding. Later versions of the RealVideo codec, such as RealVideo 8.0 and RealVideo G2, do support multiple bit rate encoding.

- 3 From the **Frame Size** list, select a size for your video frames. As frame size increases, greater bandwidth is required to stream the video. If you are encoding for slow connection speeds, such as 28.8 or 56 Kbps, it's best to select a frame size no greater than 176×144.



Tip You can also modify frame size by typing it in the session window under the **Frame Size** heading. When you modify the frame size of an encoding profile from the session window, the new frame size will apply to all the video streams of the encoded file.

- 4 From the **Video Quality** list, select the video quality that you want for your video. As you increase the sharpness of the image, the playback of the video may become less smooth.

- 5 From the **Audio Content** list, select the option that best describes the audio content of your video.
- 6 If you want to prioritize the delivery of your clip's audio during periods of Internet congestion, select **Emphasize audio**. This option, however, may cause the video portion of your clip to degrade during periods of Internet congestion.
- 7 To allow viewers to download your encoded video onto their hard drives, select **Allow download**.
- 8 To allow viewers using RealPlayer Plus to record your encoded video clip, select **Allow recording**.
- 9 Under **Filtering Options**, select the options you want:
 - **De-interlace** Select this to de-interlace the fields of your video, such as to remove flicker from a still-frame image.
 - **High-quality resize** Select this to use the high quality resize filter, which can remove aliasing or blurring when your video is resized.
 - **Inverse telecine** Select this to remove the video frames added by the telecine process.
 - **Noise Filtering** Select a noise filter from this list if you want to remove video noise distortion from the source video before it is encoded.

Selecting your Windows Media codec options

- 1 Click the **Windows Media** tab. By default, the **Codec Options** are displayed.

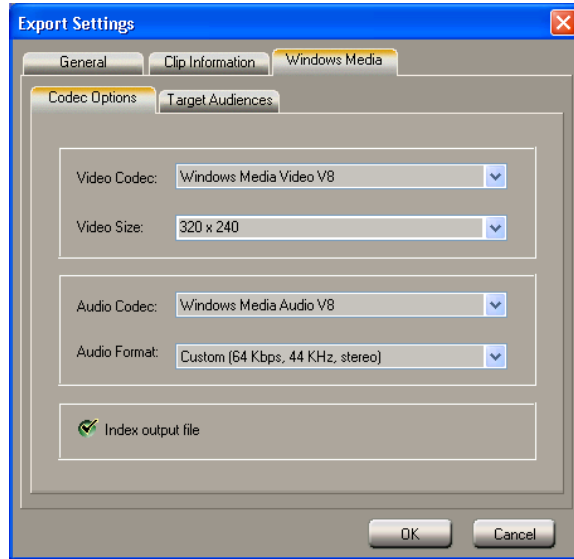

- 2 From the **Video Codec** list, select the video codec that you want to use. If you're encoding a high-action video clip for high-bandwidth Internet connections, you may want to select the latest version of the video codec.
- 3 From the **Video Size** list, select a size for your video frames. As video size increases, greater bandwidth is required to stream the video. If you are encoding for slow connection speeds, such as 28.8 or 56 Kbps, it's best to select a size no greater than 176×144.



Tip You can also modify video size by typing it in the session window under the **Frame Size** heading. When you modify the video size of an encoding profile from the session window, the new size will apply to all the video streams of the encoded file.

- 4 From the **Audio Codec** and **Audio Format** lists, select the audio codec and audio format you want to use.
- 5 Select the **Index output file** option if you want your viewers to be able to use the Windows Media Player fast forward and rewind features when they play your video.

Customizing your target audience settings

Customizing your target audience settings for RealMedia and Windows Media files, such as bit rate, frame rate, and key frame interval, lets you create video streams that are optimized for delivery over specific types of Internet connections. You can create multiple bit rate video files by adding one or more target audiences to a single bit rate encoding profile.

⇒ **To modify your target audience settings:**

- 1 Click the **Target Audiences** tab.

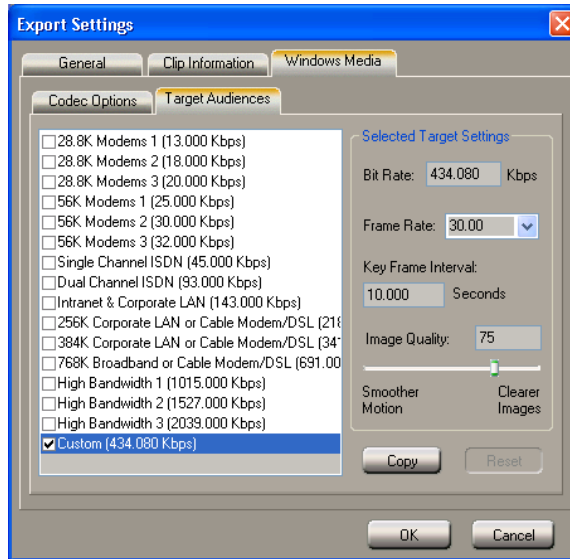

Note If you're modifying a multiple bit rate profile, check boxes for several target audiences will be selected. An individual video stream will be encoded for each selected target audience to create a multiple bit rate video file. You can change the settings for each of these target audiences.

- 2 From the list of target audiences, select (highlight) the target audience whose settings you want to change.
- 3 Change the **Bit Rate**, **Frame Rate**, and **Key Frame Interval** as needed.



Tip You can also change the frame rate by typing the value in the session window under the **Frame Rate** heading. When you modify the frame rate of an encoding profile from the session window, the new frame rate will apply to all of the profile's target audiences.

- 4 If you're modifying a RealMedia encoding profile, you can select the following options:
 - **Variable bit rate encoding** Select this to allow your video to be streamed at varying bit rates that correspond to the complexity of its content.

For example, high action segments will be allocated more bits than lower action segments, increasing the overall quality of the video without increasing the file size.

- **Lossless protection** Select this to help prevent the loss of data from your video file when it is being streamed during periods of heavy internet or network traffic.

- 5 If you're modifying a Windows Media encoding profile, drag the **Image Quality** slider to select the image quality you want. As you increase the image quality, the playback of the video may become less smooth.



Note To restore the default target audience settings, click the **Reset** button.

- 6 Click **OK** to return to the session window.

Adding target audiences to create a multiple bit rate profile

You can add multiple target audiences to a single bit rate encoding profile to create a multiple bit rate video file. For each target audience that is added to the profile, an additional video stream is encoded in the file.



To add target audiences:

- 1 From the target audience list, choose the target audiences you want to add by selecting their check boxes.

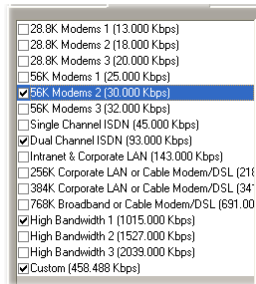

- 2 For Windows Media, you can also add target audiences by selecting (highlighting) a target audience, then clicking **Copy**. A “Custom” target audience with the source’s selected target settings is added to the end of the target audience list. You must change the bit rate value of new “Custom” target audiences before MediaExport adds them to the encoding profile.



Note The check box of a target audience doesn't need to be selected in order for it to be copied.

- 3 You can now modify the settings for each target audience, if needed.

Selecting your Ligos MPEG common settings

You can customize various common settings for the Ligos MPEG encoder, such as the video and audio file formats you want to encode.

- Important** When you customize your Ligos MPEG profile settings, ensure that your new settings are compliant with the type of stream you want to encode. Non-compliant settings may produce undesirable results in your exported video, and in some cases cause your export to be unsuccessful or unsupported by your DVD authoring program. It's recommended that only advanced users customize their Ligos MPEG profile settings in MediaExport. For details about the required settings, see [“Ligos-compliant profile settings”](#) on page 226.



To modify your MPEG common settings:

- 1 Click the **Ligos MPEG** tab. By default, the **Common** settings are displayed.

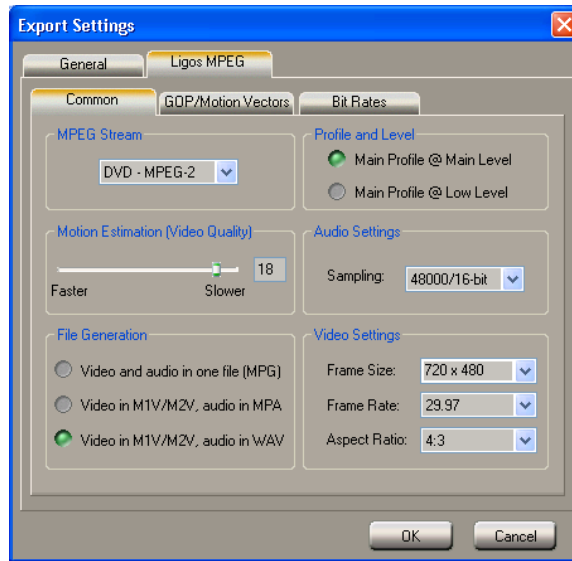

- 2 Under **MPEG Stream**, select the type of MPEG stream you want to encode.
- 3 If you are encoding an MPEG-2 video file, under **Profile and Level**, select either **Main Profile @ Main Level**, or **Main Profile @ Low Level**.
- 4 Use the **Motion Estimation** slider to select the image quality you want for your video file. In general, setting the **Motion Estimation** slider to higher numbers produces the highest quality video, but the video will take more time and processor power to encode.
- 5 From the **Audio Settings** list, select the sampling format for the audio portion of your clip.
- 6 Under **File Generation**, select the type of video and audio file you want the encoder to generate:

- **Video and audio in one file (MPG)** Generates an *.mpg* (MPEG-1 or MPEG-2 Program) file that incorporates the video and audio portions of your clip into one file.
- **Video in M1V/M2V, audio in MPA** Generates an *.m1v* (MPEG-1 Elementary) or *.m2v* (MPEG-2 Elementary) video file and a compressed *.mpa* audio file.
- **Video in M1V/M2V, audio in WAV** Generates an *.m1v* (MPEG-1 Elementary) or *.m2v* (MPEG-2 Elementary) video file and an uncompressed *.wav* audio file.

7 Under **Video Settings**, select the **Frame Size**, **Frame Rate**, and **Aspect Ratio** you want to use from the lists provided.

 **Tip** You can also modify frame size by typing it in the session window under the **Frame Size** heading.

Customizing your Ligos MPEG GOP structure and motion vector settings

You can define the properties of your video's GOP structure, including its subgroup length and placement of the sequence headers. You can also modify the size of the motion vectors for your P and B frames.

⇒ **To modify your GOP and motion vectors settings:**

1 Click the **GOP/Motion Vectors** tab.

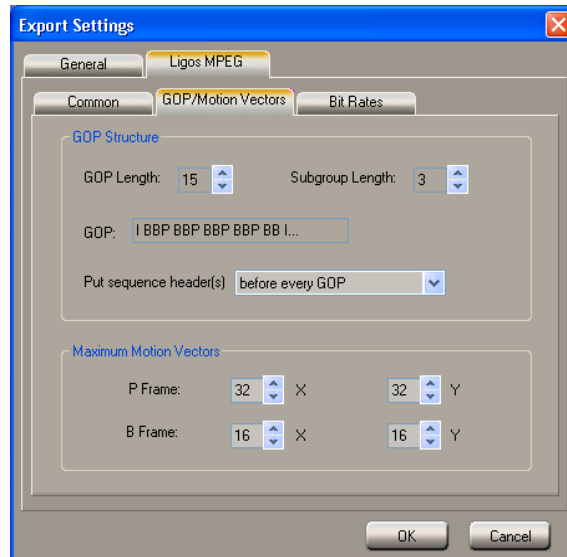

2 Under **GOP Structure**, you can set the following:

- **GOP Length** Determines the number of frames in the GOP.

– **Subgroup Length** Determines the subgroup length of B-frames and/or P-frames in the GOP, after the initial I-frame. A subgroup of 3 appears as “BBP,” a subgroup of 2 appears as “BP,” and a subgroup of 1 gives you only P-frames after the initial I-frame.

- 3 From the **Put sequence header(s)** list, select the placement frequency of the sequence header. The sequence header of an MPEG file provides information about the video stream for the decoder, such as bit rate, frame rate, and aspect ratio. Some MPEG applications require a particular frequency for the placement of the sequence headers in the file. For example, DVD-compliant video requires a sequence header before every GOP in the video file.
- 4 Under **Maximum Motion Vectors**, either select a preset value from the lists, or enter a value for the size of your P frame and B frame motion vectors. The quality of your images can be affected if the motion vector values you choose are either too long, or too short. The best image quality is most often achieved using vector lengths between 16 and 32.



Note Motion vector values must be multiples of 8 between 16 and 64. If needed, the value you enter will be set to the nearest supported value.

Customizing your Ligos MPEG bit rate settings

- 1 Click the **Bit Rates** tab.

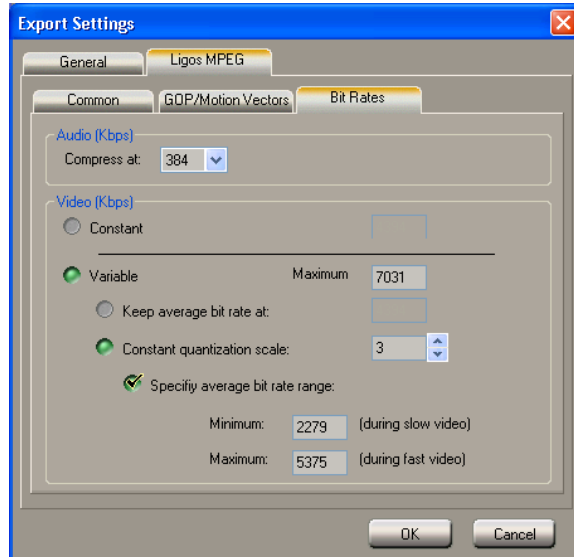

- 2 Under **Audio (Kbps)**, select a bit rate for your compressed audio (for *.mpg* and *.mpa* files only).
- 3 To select a bit rate type for your MPEG video, do one of the following:
 - Select **Constant** if you want your video to be compressed at a constant bit rate. Enter the bit rate you want to use for your video in the box provided. Your video is compressed at exactly the bit rate you enter. However, if your video is very complex (such as scenes with many colors or sharp edges), you'll need to specify a high bit rate to avoid having frames of very blocky video.
 - Select **Variable** if you want your video compressed at varying bit rates based on the complexity of the video. Enter the absolute highest bit rate for your video in the **Maximum** box, and the average target bit rate in the **Keep average bit rate at** box.



Important The maximum recommended DVD-compliant bit rate is 8000 Kbps, which should give you good results with most DVD authoring programs. If you specify a higher bit rate, be aware that it may not be supported by your authoring program. For charts of recommended bit rates, see [“Recommended MPEG data rates for distribution on DVD-R or CD-R”](#) on page 267.

- 4 If you are encoding a variable bit rate video, you can choose to control the bit rate with a quantization scale value instead of an average bit rate. To

specify a quantization scale value, select **Constant quantization scale**, then either select a preset value from the list, or enter a value between 0 and 31. For best results, select a constant quantization value between 2 and 6.

- 5 If you've selected **Constant quantization scale**, you can also select **Specify average bit rate range**, then enter an average minimum bit rate to use while encoding slow video, and an average maximum bit rate to use while encoding fast video.



Note The average maximum value you enter must be less than or equal to 14648 Kbps, and less than or equal to the **Maximum** bit rate value.

- 6 Click **OK** to return to the session window.

Ligos-compliant profile settings

As explained in “[Selecting your Ligos MPEG common settings](#)” on page 222, if you customize your MPEG settings, you must select profile settings that are compliant with the MPEG stream you're using. Non-compliant settings may produce undesirable results in your exported video, and in some cases cause your export to be unsuccessful or unsupported by your DVD authoring program. The required settings are listed in the following tables.

MPEG Stream	DVD - MPEG-2
--------------------	--------------

File Generation	Video in M1V/M2V, audio in WAV
Profile and Level	Main Profile @ Main Level
Audio Sampling	48000/16-bit
Frame Size	720 × 480 (NTSC), 720 × 576 (PAL)
Frame Rate	29.97 frames per second (NTSC), 25 frames per second (PAL)
Aspect Ratio	4:3 or 16:9
GOP Length	15
Subgroup Length	3
Put sequence header(s)	before every GOP
Audio (bit rate) Compress at	no higher than 384 Kbps
Video (bit rate)	no higher than 8000 Kbps

MPEG Stream DVD - MPEG-1

File Generation Video in M1V/M2V, audio in WAV

Audio Sampling 48000/16-bit

Frame Size 352 × 240 (NTSC), 352 × 288 (PAL)

Frame Rate 29.97 frames per second (NTSC), 25 frames per second (PAL)

Aspect Ratio 4:3

GOP Length 15

Subgroup Length 3

Put sequence header(s) before every GOP

Audio (bit rate) Compress at no higher than 224 Kbps

Video (bit rate) no higher than 1856 Kbps

MPEG Stream Super Video CD

Audio Sampling 44100/16-bit

Frame Size 480 × 480 (NTSC), 480 × 576 (PAL)

Aspect Ratio 4:3 or 16:9

GOP Length 15

Subgroup Length 3

Put sequence header(s) before every GOP

Video (bit rate) no higher than 2539 Kbps

MPEG Stream Video CD

Frame Size 352 × 240 (NTSC), 352 × 288 (PAL)

Frame Rate 29.97 frames per second (NTSC), 25 frames per second (PAL)

Aspect Ratio CCIR601 (525 lines NTSC), CCIR601 (625 lines PAL)

GOP Length 15

Subgroup Length 3

Audio (bit rate) **Compress at** no higher than 224 Kbps

Video (bit rate) no higher than 1123 Kbps

MPEG Stream MPEG-2 **Profile and Level** Main Profile @ Main Level

Video (bit rate) no higher than 14248 Kbps

MPEG Stream MPEG-2 **Profile and Level** Main Profile @ Low Level

Frame Size 352 × 240 (NTSC), 352 × 288 (PAL)

Video (bit rate) no higher than 3625 Kbps

MPEG Stream MPEG-1

Video (bit rate) no higher than 1856 Kbps

Adding your customized profile to the profile library

You can permanently save your modified profiles by adding them to the profile library. They are easily identified as customized profiles in the **Profile Library** dialog boxes by an ***** prefix.



Note If you edited a copy of a standard encoding profile, your customized profile has already been added to the profile library.

- 1 In the session window, select the encoding profile you want to add to the profile library.
- 2 Right-click the selected profile, then choose **Add To Profile Library** from the pop-up menu.
- 3 When the message box appears asking if you want to add the selected profile settings to the profile library, click **Yes**.
- 4 The **Profile Library** dialog box appears with your customized profile added to the bottom of the profile library list.
- 5 To return to the session window, click **Close**.

Saving and loading your encoding session

Once you have added all the encoding profiles that you want to use to the session window, you can save the encoding session and the settings of the selected profiles to a *.mex* file. The session and all the profile settings can then be loaded for a later session.

⇒ To save your encoding session:

- 1 Click **Save**.
- 2 In the **Save As** dialog box, name your file and click **Save**.

⇒ To load a previously saved encoding session:

- 1 Click **Load**.
- 2 In the provided dialog box, select the session (*.mex* file) you want to load, then click **Open**.



Tip You can also save and load encoding sessions by right-clicking inside the session window and choosing **Save Session** or **Load Session** from the pop-up menu.

Your notes

10

Using the Adobe After Effects plug-in

This chapter explains how to use the Adobe After Effects plug-in that comes with Matrox RT.X100 Xtreme so that you can display the contents of your Composition window on your NTSC or PAL video monitor.

About the Adobe After Effects plug-in

The Adobe After Effects plug-in, together with your Matrox RT.X100 Xtreme hardware, lets you display the contents of your Composition window in Adobe After Effects (version 4.0 or later) on your NTSC or PAL video monitor. This lets you see the exact color temperature, safe-title area, and any interlaced artifacts in your composition as you work.

Required settings to use the plug-in

- 1 Start Adobe After Effects.
- 2 Open the **Composition Settings** dialog box by choosing **Composition > New Composition**.

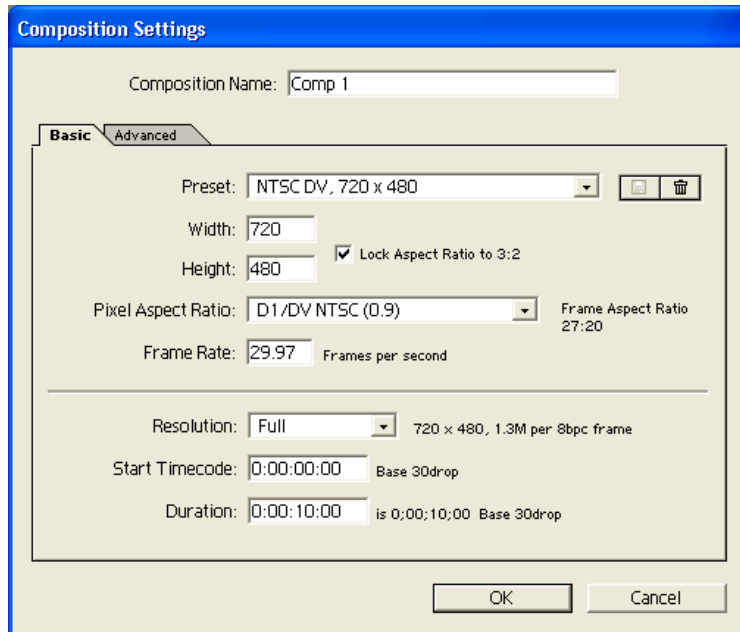

- 3 Set the **Frame Rate** to either **29.97** for an NTSC composition, or **25** for a PAL composition.
- 4 You can specify additional composition settings as explained in your *Adobe After Effects User Guide*.

i Important The following steps are applicable only if you are using After Effects version 5.0 or later. If you are using an earlier version of After Effects, you cannot change your preview settings. Therefore, you will not be able to run Adobe Premiere at the same time as After Effects.

- 5 Choose **Edit > Preferences > Matrox Preview Settings**.



Note The **Enable preview** option is selected by default. If you want to run Adobe Premiere at the same time as After Effects, then you must clear this option before you start Premiere.

- 6 Click the **Setup** button.

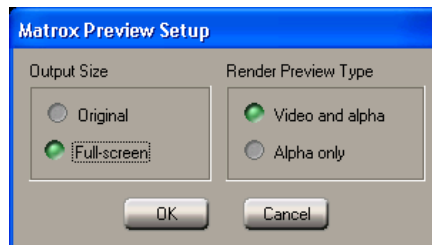

- 7 Under **Output Size**, select the size that you want your composition to be displayed on your NTSC or PAL video monitor. For example, select **Original** to maintain your composition's original size.
- 8 Under **Render Preview Type**, select one of the following options for previewing the rendering of your composition on your video monitor:
- **Video and alpha** Select this to view your composition keyed over a black background.
 - **Alpha only** Select this to view only your composition's grayscale alpha-key (matte) information.

Remarks

- When you separate fields in your imported video footage, only one video field will be displayed when you preview the video on your NTSC or PAL monitor. When you render your final image, however, it will be rendered correctly.
- You can apply the Broadcast Colors effect to your composition to reduce luminance or saturation to a safe (legal) level. To do so, select all the layers in your composition, then choose **Effect > Video > Broadcast Colors**. Choose either **NTSC** or **PAL** according to your system. For more details, see your *Adobe After Effects User Guide*.

- The plug-in supports customizing the **Width** and **Height** of your composition. If the frame size is larger than the actual screen size, the center of the image will be displayed in the Composition window.
- When performing operations such as scrubbing the Timeline, the image on your video monitor may temporarily shrink. To avoid this, choose **Edit > Preferences > Previews** and clear the **Use Dynamic Resolution** option.

11

Using the 3ds max plug-in

This chapter explains how to use the 3ds max plug-in that comes with Matrox RT.X100 Xtreme so that you can display your animation on your NTSC or PAL video monitor.

About the 3ds max plug-in

The 3ds max plug-in, together with your Matrox RT.X100 Xtreme hardware, lets you display your 3ds max animation on your NTSC or PAL video monitor. This lets you see the exact color temperature, safe-title area, and any interlaced artifacts in your animation as you work. The 3ds max plug-in supports 3ds max version 4.0.

Required settings to use the plug-in

- 1 Start 3ds max.
- 2 Open the **Render Scene** dialog box (either by clicking the **Render Scene** button on the toolbar or by choosing **Rendering > Render** from the main menu).
- 3 Under **Render Output**, click **Devices**.
- 4 Select **Matrox Video Monitor** in the **Select Image Output Device** dialog box, then click **OK**. This opens the **Matrox Preview Setup** dialog box.

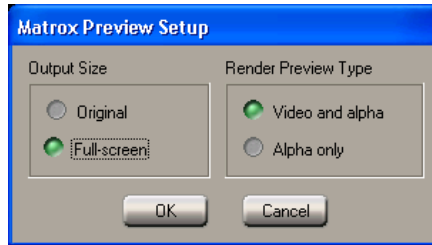

- 5 Under **Output Size**, select the size that you want your animation to be displayed on your NTSC or PAL video monitor. For example, select **Original** to maintain your animation's original size.
- 6 Under **Render Preview Type**, select one of the following options for previewing the rendering of your animation on your video monitor:
 - **Video and alpha** Select this to view your animation keyed over a black background.
 - **Alpha only** Select this to view only your animation's grayscale alpha-key (matte) information.

For details on how to render scenes, refer to your 3ds max documentation.

12

Using the LightWave 3D plug-in

This chapter explains how to use the LightWave 3D plug-in that comes with Matrox RT.X100 Xtreme so that you can display your animation on your NTSC or PAL video monitor.

About the LightWave 3D plug-in

The LightWave 3D plug-in, together with your Matrox RT.X100 Xtreme hardware, lets you display your LightWave 3D animation on your NTSC or PAL video monitor. This lets you see the exact color temperature, safe-title area, and any interlaced artifacts in your animation as you work. The plug-in supports LightWave 3D version 6.0 or later.

Required settings to use the plug-in

- 1 Start LightWave 3D.
- 2 Do one of the following:
 - If you're using LightWave 3D version 7.0 or later, choose **Rendering > Render Options**.
 - If you're using LightWave 3D version 6.0 or 6.5, choose **Extras > Render > Render Options**.
- 3 Select **Matrox_RT** as your **Render Display**. This opens the **Matrox Preview Setup** dialog box.

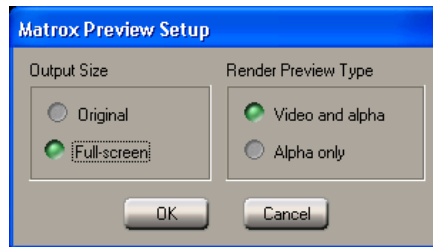

- 4 Under **Output Size**, select the size that you want your animation to be displayed on your NTSC or PAL video monitor. For example, select **Original** to maintain your animation's original size.
- 5 Under **Render Preview Type**, select one of the following options for previewing the rendering of your animation on your video monitor:
 - **Video and alpha** Select this to view your animation keyed over a black background.
 - **Alpha only** Select this to view only your animation's grayscale alpha-key (matte) information.

For details on how to render your animation, refer to your LightWave 3D documentation.

13

Using Sonic DVDit! SE

This chapter explains how to export material from Adobe Premiere for your DVD projects, and how to create a DVD volume with DVDit! SE. It also explains how to play back your DVD volumes using a software DVD player.

Overview

Sonic DVDit! is a DVD authoring program that lets you create interactive content on your PC and publish it on DVD-R or CD-R. DVDit! SE is specifically tailored for use with your Matrox RT.X100 Xtreme.



DVDit! SE allows you to output your DVD project to the following formats:

- **DVD discs** are the DVD files as they are written to recordable DVD-R or CD-R disc.
 - DVD-R discs work with any set-top or software DVD player (PC-based DVD player). The discs can contain up to two hours of high-quality video.
 - CD-R discs work only with some software DVD players, and can contain about 15 to 20 minutes of high-quality video. A special cDVD player is included with DVDit! SE. You can copy this player onto a CD-R with your DVD video, so that your project can be played back on any PC.
- **DVD volumes** are folders containing video and audio files, as well as information used by a software DVD player. You can create a DVD volume on your hard drive, and play the files using any software DVD player (such as Sonic CinePlayer, which is bundled with DVDit! SE). The DVD volume is useful for testing your project before you create a DVD disc.

Exporting material for your DVD project

The first step to creating a DVD is to get some MPEG-2 video material onto your A/V drive. You can use Adobe Premiere to either capture or export the desired video to an MPEG-2 Elementary (.m2v) file that's suitable for use with DVDIt! SE. Once you have some MPEG-2 video material, you can use DVDIt! SE to create your DVD.

⇒ To export material for your DVD project:

- 1 Start Adobe Premiere.
- 2 Open the project from which you want to export material.
- 3 Drag the ends of the work area bar so that it extends over the length of the area you want to export.
- 4 Choose **File > Export Timeline > Matrox Realtime Export to Disk**.



- 5 From the **Range** list, select **Work Area**.

Tip You can select **Entire Project** if you want to export your entire Timeline, rather than the area selected with the work area bar.

- 6 From the **Format** list, select **MPEG-2 IBP (.m2v)**.
- 7 If you want to export video with associated audio, select **Uncompressed (.wav)** from the **Audio** list.
- 8 Specify the drive and the folder where you want to store your .m2v file (and .wav file, if applicable). This drive should be different from the drive you use to store your project's clips. You may want to create a folder on your export A/V drive for your DVDIt! SE exports.

9 Click the **Configure** button. This displays the following dialog box:

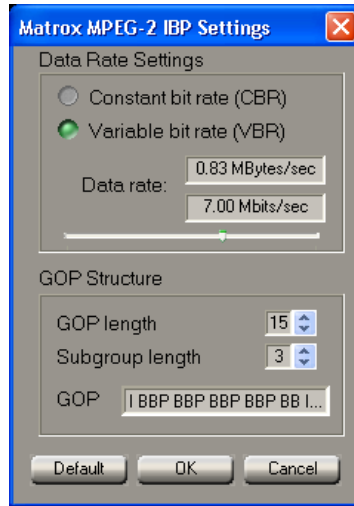

- 10 Click the **Default** button. This sets the **Data Rate Settings** and **GOP Structure** to recommended DVD-compliant settings that are suitable for use with DVDit! SE.
- 11 Click **OK** to return to the **Matrox Realtime Export to Disk** dialog box.
- 12 Click **OK** to begin the export and quit Adobe Premiere once the export is complete.

For more information on performing a realtime export to disk, see [“Performing a Matrox realtime export to disk”](#) on page 65.



Note You can also use Matrox MediaExport to create DVD-compliant MPEG-2 files, but MediaExport can’t export your video in real time. For more information, see [Chapter 9, “Using Matrox MediaExport.”](#)

Creating a DVD volume

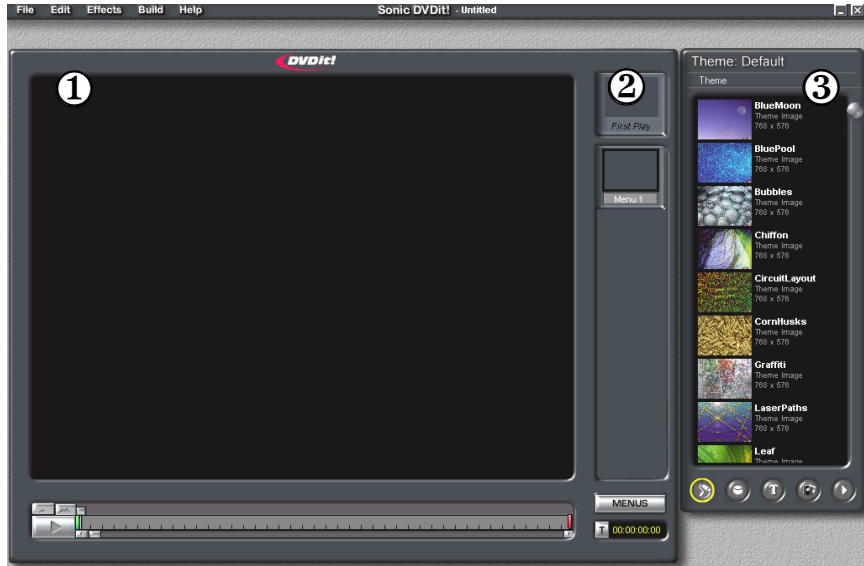

① Video Monitor ② “First play” placeholder ③ Palette Window

You can use DVDit! SE to create a DVD volume, which can be played using a PC-based software DVD player (for example, Sonic CinePlayer). The following steps explain how to create a simple DVD volume. For complete details on how to use DVDit! SE, see your *DVDit! User Manual*.

- 1 Start DVDit! SE.
- 2 In the Project Planner that opens, click **Start a New Project**.
- 3 In the next dialog box, under **Choose a Video Format**, select **MPEG2 (DVD-compliant)**. Click **Finish**.



- 4 Click the **Backgrounds** button on the Palette Window. Notice that the default theme backgrounds are automatically loaded. Select a background by dragging it to the “First play” placeholder.



- 5 Click the **Buttons** button on the Palette Window. Drag any button to the Video Monitor.

- 6 Click the button in the Video Monitor to resize it. A white border with handles now appears. Drag any of the eight handles to resize the button vertically, horizontally, or diagonally.



Tip You can use **CTRL+click** to select multiple buttons and resize them simultaneously.



- 7 Click the **Media** button on the Palette Window. Right-click on the Palette Window, then click **Add File To Theme**. Locate the video file (and associated audio file, if applicable) that you exported from Adobe Premiere. Right-click the video file and click **Play** to watch it play back in the Video Monitor. Right-click the audio file and click **Play** to listen to it.

- 8 Drag the video file from the **Media** section of the Palette Window and drop it on the button you added to the Video Monitor. This creates a link between the button and the video. Drag the corresponding audio file to the same button. To see what media is linked to your button, right-click anywhere in the Video Monitor and choose **Show Button Links**. Notice that the file names are listed. Right-click anywhere in the Video Monitor and choose **Hide Button Links** to return to the normal view.



Tip You can also create buttons by simply dragging any thumbnail from the **Media** section of the Palette Window and dropping it directly on the Video Monitor. A rectangular button with the thumbnail superimposed on the front will be created.



- 9 Click the **Text** button on the Palette Window. The default list of all the font styles on your computer appears. Select a font style and drag it to the Video Monitor. The word “Text” appears in the font style you’ve chosen.

- 10 Double-click the word “Text” to highlight it for editing. Enter your own text. Once you are finished entering your text, click anywhere in the Video Monitor to see the end result.

- 11 Click your text to resize it. Choose **Effects > Text Properties** to apply color and shading effects to your text. Experiment with various settings. Click **OK** when you are finished.



Tip You can link video material or still images to text, just as you can with buttons. Simply drag the media material and drop it on the text.



- 12 Click the **Play** button on the Palette Window to preview your DVD project. Preview mode simulates how the DVD project will respond once it’s completed. You can click the buttons on the Video Monitor to test the video clips or still images. Notice how the buttons and text become highlighted when you place the mouse pointer over them. The Remote Control behaves just like a real DVD player remote control, with buttons for play, stop, skip, menu, and title. Close the Remote Control when you’re finished.

- 13 Choose **File > Save** to save your project.

- 14 Choose **Build > Make DVD Folder** to build your DVD volume. In the **Path** section, click **Browse** to name your folder and specify your video drive. All the other settings can be left as is:

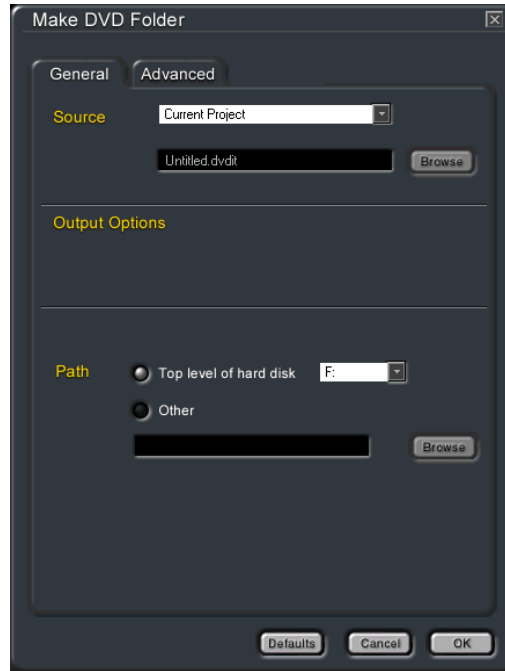

- 15 Click **OK**. Your DVD volume will now start to build. When it is complete, click **OK**.
- 16 Quit DVDIt! SE.

Playing your DVD volume using a software DVD player

You can create a DVD volume on your hard drive, and play the files using any software DVD player (such as Sonic CinePlayer, which is bundled with DVDIt! SE).

Use the browse function of the software DVD player you're using to locate the *video_TS* folder. Open the folder and select the *video_ts.ifo* file. This file contains all the information your software DVD player needs for playing back the DVD volume.



Note Some software DVD players scan your computer drives for the *video_TS* folder and play the *video_ts.ifo* file automatically. With some older software DVD players, your DVD volume must be at the top level of your disk before it can be played. For more information, see your *DVDIt! User Manual*.

Playing your DVD volume using a software DVD player

Your notes

14

Using the WYSIWYG DirectShow Control Panel

This chapter explains how to use the WYSIWYG DirectShow Control Panel to display clips played back using DirectShow programs on your NTSC or PAL video monitor.

Overview

The WYSIWYG DirectShow Control Panel lets you display video played back using Windows Media Player, Sonic DVDIt! SE, and other supported DirectShow applications on your NTSC or PAL video monitor. This gives you a WYSIWYG (What You See Is What You Get) video display for checking how your clips appear on a TV or other interlaced monitor.

The supported file types are: Matrox *.avi* and *.m2v* files, as well as Video CD and Super Video CD files (*.mpg*, *.m1v*, and *.m2v* files).

If you've connected an S-Video or composite video recorder to your RT.X100 Xtreme system, you can record your clips onto tape as they play back on your video monitor.

Remarks

- To disable and re-enable the Matrox WYSIWYG DirectShow output to your video monitor, you must log onto an account on your Windows system that has Administrator privileges. For details, consult the appropriate Microsoft documentation.
- When playing non-interlaced video clips on your video monitor, you may see some flickering in your image that is not present in the image on your computer screen. This is normal.

Configuring the WYSIWYG DirectShow Control Panel

- 1 To open the WYSIWYG DirectShow Control Panel, click the  icon on your Windows taskbar.



Note If you are using Windows XP and do not see the , right-click the taskbar and choose **Properties**. Clear the **Hide inactive icons** option, and click **OK**.

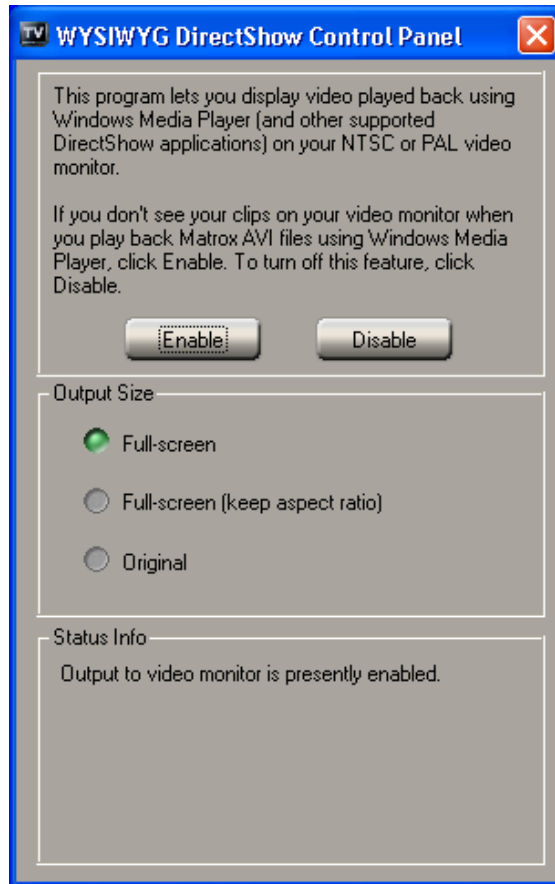

- 2 By default, the Matrox WYSIWYG DirectShow output to your NTSC or PAL monitor is enabled. Some DirectShow applications, however, may not display the video properly. If this happens, you can disable the display on your video monitor by clicking the **Disable** button.



Note After choosing **Enable** or **Disable**, you'll need to restart your DirectShow application for the change to take effect.

- 3 Under **Output Size**, select the size that you want your video to be displayed on your NTSC or PAL video monitor. For example, select **Original** to maintain the original size of your clip.



Note When you select a different output size, you won't see the change on your video monitor until you pause your video clip and start the playback again.

15

RT.X100 Xtreme Troubleshooting

This chapter provides some possible answers if you have trouble installing or operating your RT.X100 Xtreme system.

Problems, possible causes, and solutions

Up-to-date information

The following pages contain information about the most common problems solved by our RT. X Support department. These solutions are also available on our web site at www.matrox.com/videoweb/support in the RT.X Support section. As new information becomes available, we'll add it there first, so it's always a good idea to check the site on a regular basis.

Possible solutions

Many of the troubleshooting items listed here, as well as others not included, could be solved by upgrading all of your hardware and software to the latest available versions. For hardware such as your motherboard, sound card, and storage devices, check the manufacturers' web sites for the latest updates that you can download and install. As for Matrox hardware and software, check the RT.X Support section of our web site for the latest updates and patches.

Multiple solutions

Some of the problems identified here may have more than one possible cause, and there are frequently several possible solutions. Solution instructions may vary depending on your operating system (Windows XP or Windows 2000).



Warning Never open your computer system when its power is on!

Installation/configuration

The card does not fit

Possible cause 1 New or unused slots If you're installing your card in new or previously unused slots, there may be considerable resistance as the card slides into the slots. This is normal.

Solution Install carefully Make sure that the card is perfectly aligned with the slots and push it in firmly but gently until it is correctly seated.

Possible cause 2 Wrong slot You may be installing your RT.X100 Xtreme card in the wrong slot.

Solution Use PCI slot Make sure to install your RT.X100 Xtreme card in a PCI slot.

System freezes, shuts down, or crashes randomly

Possible cause 1 Other programs running You should not run any other programs at the same time as Adobe Premiere. Screen savers and programs that use a large amount of system memory, such as most paint and compositing applications, can cause problems if you run them at the same time as Premiere.

Solution Quit all other programs Make sure you quit all other programs you have running at the same time as Premiere.

Possible cause 2 Overheating It's important to provide adequate ventilation in your computer system because your RT.X100 Xtreme card generates a significant amount of heat.

Solution 1 Provide ventilation Make sure your computer system is well ventilated with no obstructions blocking any openings, especially at the rear of the unit.

Solution 2 Operate in a safe area Avoid operating your RT.X100 Xtreme system in areas with an ambient temperature above 55°C.

Option to switch video standards isn't available

Possible cause Option wasn't selected You did not select the option to be able to switch your video standard when you installed Matrox X.tools.

Solution Re-install software If you'd like to be able to switch video standards without re-installing Matrox X.tools, you must select the option **Install all files to be able to switch the video standard without re-installing X.tools** when prompted during the X.tools install. When you want to switch your video standard, choose **Start > Programs > Matrox X.tools > Switch Your Video Standard**.

Using Adobe Premiere

Video file playback is jerky (dropping frames)

Possible cause 1 Wrong drive or system not powerful enough You may not be using your A/V drive for playback, or your system is not powerful enough for realtime video editing.

Solution 1 Check drive properties Make sure your A/V drives are NTFS, and not compressed to save disk space. In Windows Explorer, right-click the drive letter (such as D:), then choose **Properties**. Under **General**, make sure that **Compress drive to save disk space** is not enabled.

Solution 2 Check settings for scratch disks In Adobe Premiere, you can check your scratch disks by choosing **Edit > Preferences > Scratch Disks and Device Control**. Be sure to specify the appropriate A/V drive letter for **Captured Movies, Video Previews** and **Audio Previews**. For more information, see [“Setting up your scratch disks”](#) on page 42.

Solution 3 Use the Force render option or upgrade CPU Some of the complex realtime Matrox effects, or certain combinations of effects, may cause dropped frames during playback. For those cases, do one of the following:

- Use the **Force render** option to ensure smooth playback without dropped frames. For more information, see [“Using common controls in the plug-in”](#) on page 84.
- Upgrade to a faster CPU. You can monitor your CPU usage by right-clicking on the Windows toolbar, and choosing **Task Manager**. On the **Performance** tab, choose **Options** and make sure that **Always On Top** is selected. Double-click anywhere in the dialog box to resize the **CPU Usage** window. If your CPU usage reaches and maintains 100% for too long while playing back a segment of the Timeline, you will drop frames.

Possible cause 2 Fragmented drive Your A/V drive may be fragmented.

Solution Defragment Try defragmenting your A/V drive. To defragment a hard disk, choose **Start > Programs > Accessories > System Tools > Disk Defragmenter**. For more information on how to defragment your storage devices, see your Windows documentation.

Possible cause 3 Other programs running You should not run any other programs at the same time as Adobe Premiere. Screen savers and programs that use a large amount of system memory, such as most paint and compositing applications, can cause problems if you run them at the same time as Premiere.

Solution Quit all other programs Make sure you quit all other programs you have running at the same time as Premiere.

Possible cause 4 Motherboard drivers not updated Your motherboard or chipset drivers may not be up to date.

Solution Update drivers Update your drivers. For an updated list of recommended motherboard and chipset drivers, see the RT.X Support section of our web site at www.matrox.com/videoweb/support.

Possible cause 5 DMA may not be enabled on your A/V drive If your A/V drive is an EIDE device and DMA bus-mastering is not enabled, your drive won't be able to support realtime video editing on Matrox RT.X100 Xtreme.

Solution Enable DMA Make sure that DMA is enabled for all EIDE devices. For more information, see your Windows documentation.

Adobe Premiere displays error message "The Matrox realtime plug-in could not start"

Possible cause 1 Other programs running You should not run any other programs at the same time as Adobe Premiere. Screen savers and programs that use a large amount of system memory, such as most paint and compositing applications, can cause problems if you run them at the same time as Premiere.

Solution Quit all other programs Make sure you quit all other programs you have running at the same time as Premiere.

Possible cause 2 Incorrect display properties You may not have configured your Windows display properties correctly.

Solution Set your display properties Your Windows display should be configured to a resolution of at least 1024×768 pixels with either 16-bit or 32-bit color. We recommend 16-bit color for better performance. For complete details, see [page 12](#).

Possible cause 3 Incorrect display driver You may not have installed your display driver correctly, or your display driver is not up to date.

Solution Re-install the driver If you use a display driver that is included with your Windows operating system, you should upgrade to the latest version. For an up-to-date list of tested display cards and drivers for your RT.X100 Xtreme system, see the RT.X Support section of our web site at www.matrox.com/videoweb/support.

Possible cause 4 Device drivers not installed correctly Your device drivers may be corrupted or not installed correctly.

Solution Re-install software or drivers Uninstall Matrox X.tools and Adobe Premiere. Re-install Premiere, then re-install Matrox X.tools.

Possible cause 5 Problem with your sound card Your sound card may be defective, or you may not have installed your sound card correctly.

Solution Re-install your sound card Try re-installing your sound card, or replacing your sound card. For an up-to-date list of tested sound cards for your RT.X100 Xtreme system, see the RT.X Support section of our web site at www.matrox.com/videoweb/support.



Note If the Matrox realtime plug-in still won't start after trying the above solutions, contact Matrox RT.X Customer Support. You may be asked to provide the information listed under **Tech Info** in the error message.

Adobe Premiere freezes when using DV-1394 device control

Possible cause 1 Non-compatible device You may be using a non-compatible DV-1394 device.

Solution Use only compatible DV-1394 devices For an updated list of compatible DV-1394 devices, see the RT.X Support section of our web site at www.matrox.com/videoweb/support.



Note Some compatible devices don't support device control. However, you'll be able to manually control your device for capture or recording onto tape.

Possible cause 2 Wrong time code on DV tapes Your DV tape may not have continuous time code.

Solution Use only continuous time code tapes To use DV-1394 device control, your DV tapes **must** contain continuous and consecutive time code.

Possible cause 3 Mixed DV tape format The format of your DV tape must match the format you're recording.

Solution Use only one DV tape format Mixed format tapes are not supported. For example, if you set your DV-1394 device to record in DV/DVCAM format, your tape must be striped entirely in DV/DVCAM format.

Possible cause 4 Wrong video standard When installing Matrox X.tools, you may have selected the wrong video standard for your system.

Solution Switch your video standard If you selected the option **Install all files to be able to switch the video standard without re-installing X.tools** when prompted during the X.tools install, you'll be able to switch your video standard by choosing **Start > Programs > Matrox X.tools > Switch Your Video Standard**. You **must** select the video standard that matches your equipment. For example, you cannot use a PAL camera on an NTSC system.

Unable to save entire project to disk

Possible cause 1 Scratch disks not set to A/V drive You may not have set up your scratch disks properly in Premiere.

Solution Check settings for scratch disks In Adobe Premiere, you can check your scratch disks by choosing **Edit > Preferences > Scratch Disks and Device Control**. Be sure to specify the appropriate A/V drive letter for **Captured Movies, Video Previews** and **Audio Previews**. For more information, see [“Setting up your scratch disks”](#) on page 42.

Possible cause 2 Fragmented drive Your A/V drive may be fragmented.

Solution Defragment Try defragmenting your A/V drive. To defragment a hard disk, click **Start > Programs > Accessories > System Tools > Disk Defragmenter**. For more information on how to defragment your storage devices, see your Windows documentation.

Possible cause 3 Not enough space Your A/V drive may not have enough space to save your project.

Solution Free some space Remove unnecessary files not related to your project to free up some space, or install a larger A/V drive.

A/V synchronization is poor when playing back from the Timeline

Possible cause 1 Non-compatible sound card You may be using a non-compatible sound card.

Solution Use only compatible sound cards For an updated list of compatible sound cards, see the RT.X Support section of our web site at www.matrox.com/videoweb/support.

Possible cause 2 Audio Capture Drift Detection test not run The first time you try to perform an analog capture in Adobe Premiere, you're prompted to run the Audio Capture Drift Detection test to ensure proper audio and video synchronization between your sound card and your Matrox RT.X hardware. This test **must** be run prior to performing an analog capture. If you update or re-install the drivers for your sound card, or move your sound card to another slot, you should run the Audio Capture Drift Detection test again.

Solution Run the Audio Capture Drift Detection test Run the test manually.



To run the Audio Capture Drift Detection test:

1 Choose **Start > Programs > Matrox X.tools > Audio Capture Drift Detection**.

2 From the **Test Duration** list, select a duration for the test. In most cases, five minutes will give you good results.



Note If you often perform long analog captures (longer than one hour), it's recommended that you select one of the longer test durations from the **Test Duration** list (such as 10 minutes).

3 Click **Start** to run the test.

Unable to see underlying clip in Matrox effect

Possible cause 1 Moved clip from Video 1 track If you move a video clip from the Video 1 track to the Video 2 track or higher (that is, a superimpose track) for the purpose of applying a Matrox video effect to the clip, you'll have to apply an Alpha Channel key to the clip in order to see the underlying clip in your effect. You do **not** have to do this for video clips placed directly on a superimpose track.

Solution Place video clip directly on superimpose track You'll be able to see the underlying clip in your Matrox effect when you place it directly on a superimpose track (Video 2 or higher). For more information, see your *Adobe Premiere User Guide*.

Possible cause 2 Applied Matrox video effect to a graphics clip If you apply a Matrox video effect to a graphics clip on a superimpose track (Video 2 or higher), you must apply an Alpha Channel key to the clip in order to see the underlying image.

Solution Apply Alpha Channel key Right-click your graphics clip on the superimpose track and choose **Video Options > Transparency**. In the **Transparency Settings** dialog box, choose **Alpha Channel** as the **Key type**.

Capture issues

Can't capture with DV-1394, Y/C, or composite input

Possible cause 1 Incorrect connections to breakout cable You may not have properly connected your video camera or deck to the breakout cable.

Solution Check connections Make sure you have properly connected your devices to the breakout cable. See [Chapter 3, “Installing Your RT.X100 Xtreme and Connecting Your Devices.”](#)

Possible cause 2 Incorrect video input settings Your video input settings in Adobe Premiere may not be correct.

Solution Make sure video input settings are correct In Premiere, make sure that you have selected the proper video input for your device in **Project > Project Settings > Capture > A/V Inputs**. Under **Video Source**, make sure you've selected the source you want to use (**Composite**, **S-Video**, or **DV-1394**). If using a DV-1394 device for capture, make sure that Matrox DV-1394 Device Control is set in **Edit > Preferences > Scratch Disks and Device Control**.

Possible cause 3 Non-compatible device You may be using a non-compatible DV-1394 device.

Solution Use only compatible DV-1394 devices For an updated list of compatible DV-1394 devices, see the RT.X Support section of our web site at www.matrox.com/videoweb/support.

Possible cause 4 DV-1394 device drivers not installed correctly Your DV-1394 device drivers may be corrupted or not installed correctly.

Solution 1 Re-install device drivers Uninstall and re-install your DV-1394 device drivers. For details, see your Windows documentation.

Solution 2 Re-install software or drivers Uninstall Matrox X.tools and Adobe Premiere. Re-install Premiere, then re-install Matrox X.tools.

Export issues

Unable to export to tape via DV-1394

Possible cause 1 Non-compatible device You may be using a non-compatible DV-1394 device.

Solution Use only compatible DV-1394 devices For an updated list of compatible DV-1394 devices, see the RT.X Support section of our web site at www.matrox.com/videoweb/support.

Possible cause 2 Video preview during export enabled On certain systems, export to tape will not work if video preview during export is enabled.

Solution Disable video preview during export Clear **Enable video preview during export** in the **Matrox Advanced Settings** dialog box on the **DV-1394** page (choose **Project > Project Settings > General > Advanced Settings**). Be aware that the preview will be disabled on your computer monitor. You'll still be able to preview the video you're exporting on your NTSC or PAL video monitor, assuming you've connected the analog video output of your DV-1394 device to your video monitor.



Note If you clear the **Enable video preview during export** option after a failed DV-1394 export to tape, you'll need to restart your computer before starting the export to tape again.

Possible cause 3 Using Print to Video You may be trying to print to video instead of exporting to tape.

Solution Use Export to Tape In Adobe Premiere, choose **File > Export Timeline > Export to Tape**.

Export to Tape dialog box does not provide options as documented in the RT.X100 Xtreme manual

Possible cause Matrox DV-1394 Device Control not selected You may be using the Adobe Premiere DV device control instead of the Matrox DV-1394 device control. To perform a Matrox DV-1394 export to tape, you must set your device control to **Matrox DV-1394 Device Control**.

Solution Select Matrox DV-1394 Device Control Choose **Edit > Preferences > Scratch Disks and Device Control**. Under **Device Control**, select **Matrox DV-1394 Device Control**. When you export your Timeline to DV tape, the **Matrox DV Export to Tape** dialog box will be displayed.

Audio issues

Sound doesn't capture or print to tape, video files play back with no sound, or sound output is distorted or too loud

Possible cause 1 Incorrect adjustments If the sound problem is with a particular device (for example, TV or speaker), the volume control on the device itself may need adjusting.

Solution Adjust volume Adjust the volume control on the device.

Possible cause 2 Bad connections Audio cables may be loose or incorrectly wired.

Solution Check connections Make sure that all audio connections to the breakout cable are correct (see [Chapter 3, "Installing Your RT.X100 Xtreme and Connecting Your Devices"](#)).

Possible cause 3 Incorrect adjustments in Windows Your sound card's software settings may be incorrect. Specifically, input or output may be disabled, or volume levels may be too low or too high.

Solution Check adjustments Make sure your sound card's playback and recording levels are correctly set as explained in "[Set your volume levels](#)" on page 13.

Possible cause 4 RCA cables not properly attached You may not have attached your audio cables to the breakout cable.

Solution Re-attach cables Make sure that your RCA audio cables are securely attached and in the proper jacks on your breakout cable.

No audio output from the PC speakers or breakout cable

Possible cause Bad connections Audio cables may be loose or incorrectly wired.

Solution Check connections Make sure that all audio connections to the breakout cable are correct (see [Chapter 3, "Installing Your RT.X100 Xtreme and Connecting Your Devices"](#)).

Windows cannot play .wav files

Possible cause No sound card installed A Windows message will appear if you try to play any system sounds or any non-RT.X100 Xtreme related sounds, without having a sound card installed.

Solution Install a sound card Make sure you have a sound card, and that it is installed correctly.

DVD/CD authoring

DVD video playback is jerky (skipping frames)

Possible cause Slow player Your DVD drive may be too slow.

Solution Enable DMA If your DVD drive supports DMA, DMA will automatically be enabled in Windows. Not all DVD drives, however, support DMA well. For more information, see the documentation that came with your DVD drive.

Can't play certain DVD videos

Possible cause Wrong region settings A DVD video may not play back because the region setting on your DVD player doesn't match the region code on the DVD-ROM disc. DVD players and videos use region codes to prevent the playback of video that was intended only for a certain region or market.

Solution Get correct version To get a copy of a DVD video that's compatible with the region code of your DVD player, contact the vendor of that video.

A

Data Rates and A/V Disk Space Requirements

This appendix provides the approximate disk space requirements for creating video and audio files on your Matrox RT.X100 Xtreme system. It also includes charts showing the recommended MPEG data rates for distribution on DVD-R or CD-R.

DV/MPEG-2 qualities and required disk space

The following table shows approximately how much disk space you'll need per minute of video when creating DV/DVCAM .avi files and MPEG-2 Elementary (.m2v) files at various data rates.

Video Quality	Data Rate ¹ (Mb/sec)	Data Rate ² (MB/sec)	Compression Ratio	File Size (MB/min)	Min/1 GB ³ of storage
DV/DVCAM	25.0	2.98	5:1	178.0	5.8
MPEG-2	2.0	0.24	61.7:1	14.0	73.0
MPEG-2	7.0	0.83	17.8:1	49.8	20.6
MPEG-2	9.0	1.07	13.8:1	64.0	16.0

¹ In this calculation, a megabit (Mb) is equal to 1,000,000 (1000×1000) bits.

² In this calculation, a megabyte (MB) is equal to 1,048,576 (1024×1024) bytes.

³ In this calculation, a gigabyte (GB) is equal to 1024 megabytes (MB), the conventional value used for calculating storage.

Audio sampling and required disk space

The following table shows how much disk space you'll need per minute of audio sampled on your Matrox RT.X100 Xtreme.

Sampling Rate	Bits per Sample	Type	File Size (MB/min)	Min/1 GB of Storage
48 kHz	16	Stereo	11	93.1

Recommended MPEG data rates for distribution on DVD-R or CD-R

The following charts show the data rate you should select when creating MPEG files to get the best video quality for your DVD projects. These data rates are calculated according to the length of your project and the size of your distribution medium. When disk space is not an issue, such as when your project is short, you'll get the best quality using a high constant bit rate (that is, 7 Mbits/sec). When disk space is at a premium, you should use a variable bit rate.

At data rates of 2 Mbits/sec and higher, you can use Adobe Premiere to either capture or export the desired video to an MPEG-2 Elementary (.m2v) file (see "Defining your Capture settings" on page 55 and "Performing a Matrox realtime export to disk" on page 65). At data rates lower than 2 Mbits/sec, you'll need to create an MPEG-1 file. You can do this using the Ligos MPEG encoder provided with Matrox MediaExport (see Chapter 9, "Using Matrox MediaExport").



Note These charts assume that your DVD project includes 48-kHz, 16-bit stereo audio. Be aware that your DVD authoring program may create additional files that will limit the amount of space available for your DVD project.

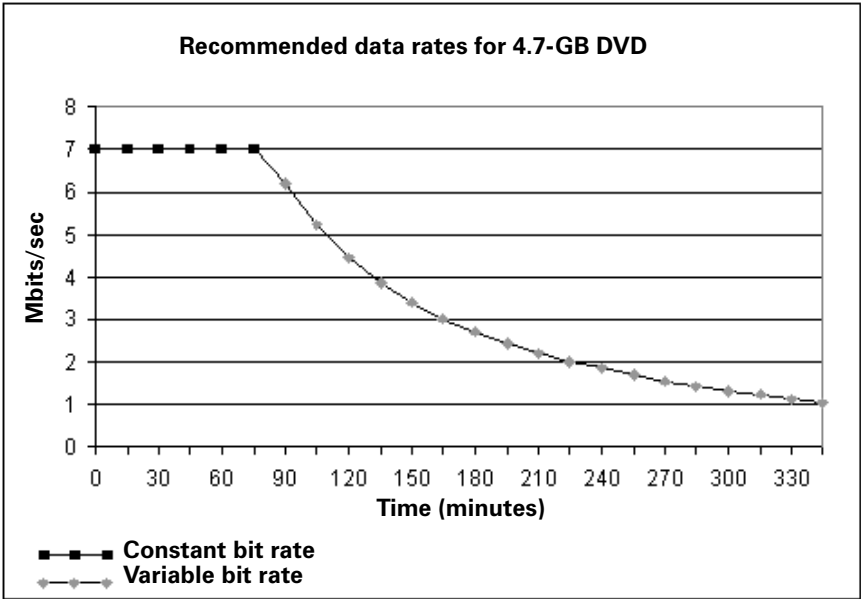

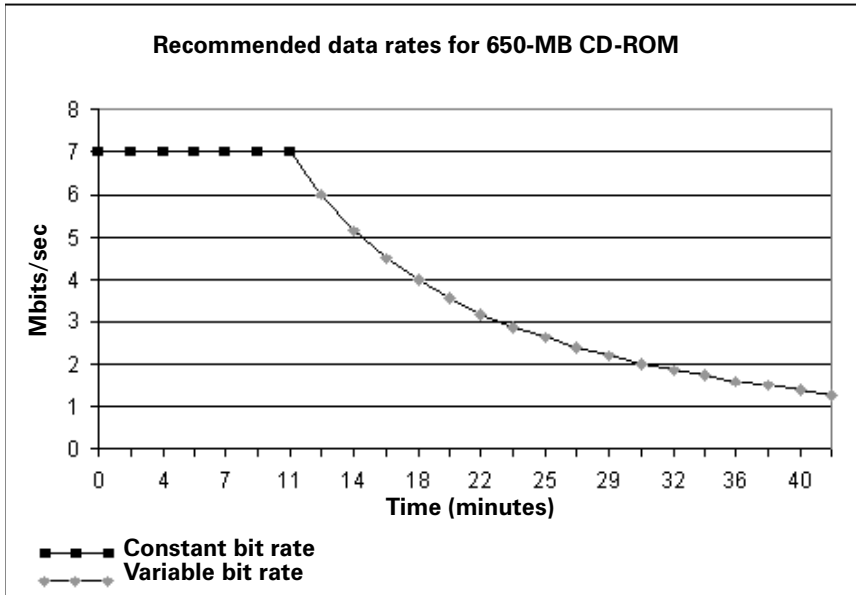

B

RT.X100 Xtreme Specifications

This appendix provides specifications for your RT.X100 Xtreme card.

Matrox RT.X100 Xtreme card specifications

General

PCI interface	3/4-size PCI card
Regulatory compliance	FCC Class B, CE Mark Class B, ACA Class B, BSMI Class B, VCCI Class B
Nominal card dimensions	Card 8.4" × 4.2" Card including bracket 8.9" × 5.0" Overall thickness including components 0.7"

Video

Inputs	1394 6-pin Composite video (CVBS), RCA jack S-Video (Y/C), mini-DIN NTSC, PAL, and SECAM
Outputs	1394 6-pin Composite video (CVBS), RCA jack S-Video (Y/C), mini-DIN NTSC and PAL
Video formats	ITU-R601 NTSC: 720×480 at 29.97 frames/sec PAL/SECAM: 720×576 at 25 frames/sec 4:3 and 16:9 aspect ratios
Video overlay	NTSC and PAL video-in-a-window support on console
Realtime video codec	Capture DV, DVCAM (NTSC 4:1:1, PAL 4:2:0), MPEG-2 MP@ML IBP from 2 to 10 Mbps Playback DV, DVCAM (NTSC 4:1:1, PAL 4:2:0) Export DV, DVCAM (NTSC 4:1:1, PAL 4:2:0), MPEG-2 MP@ML IBP from 2 to 10 Mbps

Audio

Analog audio input/output	Dependent on sound card
Audio sampling method	16-bit, 48 kHz

Environmental specifications

- Minimum/maximum ambient operating temperatures: 0 to 55° C
- Minimum/maximum storage temperature: -40 to 75° C
- Maximum altitude for operation: 3,000 meters
- Maximum altitude for transport: 12,000 meters
- Operating humidity: 20 to 80% relative humidity (non-condensing)
- Storage humidity: 5 to 95% relative humidity (non-condensing)

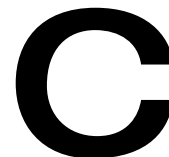

Matrox RT.X100 Xtreme Glossary

This glossary defines many of the terms used in this manual and in related Matrox RT.X100 Xtreme documentation.

Glossary of terms

Use this glossary as a reference for many of the basic terms in your RT.X100 Xtreme manual and related documentation.

Numerics

1394 *See* IEEE-1394.

2D Short for two-dimensional. An image that has height and width only.

3D Short for three-dimensional. An object in three dimensions has height, width, and depth. Various techniques are used to show 3D images on 2D surfaces like your computer screen.

3D tile A Matrox effect that uses rotating tiled patterns with various numbers of rows and columns.

4:2:2P@ML 4:2:2 Profile@Main Level. An international standard video compression profile introduced by MPEG-2. It supports 4:2:2 luminance/chrominance sampling at up to 720 × 608 pixel resolution, and data transfer rates up to 50 Mb/sec (5.96 MB/sec). This profile is used for high-quality distribution and for archiving. *See also* MP@ML.

A

A/B roll Typically, A/B roll is an editing technique where scenes or sounds on two source reels (called roll A and roll B) are played simultaneously to create dissolves, wipes, and other effects. On nonlinear editing systems, A/B roll refers to using two source streams (.avi, .wav, .tga, and so on) to create an effect.

AGP slot Connection slot to a type of expansion bus found in most current computers. The AGP slot is used to house the display card.

alpha key An effect that makes parts of a foreground image fully or partially transparent based on alpha (transparency) values stored within the image's file, so that an underlying image can show through. *See also* chroma key and luma key.

analog component video *See* component video.

analog signal A video or audio signal that varies continuously, as opposed to a digital signal which varies only by fixed steps.

anti-aliasing A technique that smooths jagged edges in computer-generated text or graphics.

aspect ratio A width-to-height ratio. For example, a 12-by-9-inch image has an aspect ratio of 4:3 (four-to-three). Most TV screens have a 4:3 aspect ratio. HDTV screens have a 16:9 aspect ratio.

assemble editing Recording new video and audio material sequentially onto tape. Because all the signals are recorded (video, audio, and control track), the new material completely replaces any previously recorded material on the tape. *See also* insert editing.

AVI Audio Video Interleaved. A video file format designed for the Microsoft Windows environment. *See also* codec.

A/V drive A hard drive capable of storing high-bandwidth audio/video data.

B

B-frame (Bi-directional frame) A frame created during the MPEG or MPEG-2 IBP compression process. A B-frame is generated by forwards and backwards referencing of the P-frames and I-frames respectively, which allows it to have the highest compression ratio of the three frame types. B-frames contain

only predictive data (that is, not enough data to make up an entire picture), and therefore cannot be edited independently.

BIOS Basic Input/Output System settings for system components, peripherals, etc. This information is stored in a special battery-powered memory and is usually accessible for changes at computer start-up.

bitmap A graphics image in which a set of values defines each pixel's relative brightness and color.

Blue Book standard *See* DV.

black level The level of brightness at which no light is emitted from the screen (reference black). The standard black level is 7.5 IRE for NTSC video, or 0 IRE for NTSC-EIAJ (Japan) and PAL video. *Also called* setup (NTSC video only). *See also* white level, super black, and super white.

blur effect A Matrox effect that uses various levels of intensity to blur an image.

bus A shared set of hardware lines that lets different parts of your computer transfer information between one another. A card inserted into an expansion slot of your computer makes an electrical connection to the bus and effectively becomes part of your computer system.

C

capture The process of digitizing video or audio material, usually from a VTR or camera, and storing it in a file on a hard disk.

chroma key An effect that makes portions of a foreground image fully or partially transparent based on the color of that image, so that an underlying image can show through. *See also* alpha key and luma key.

chrominance The color portion of a video signal that carries the hue and saturation information. *See also* luminance.

codec Compressor/decompressor. A processor that compresses video to reduce its file size by eliminating redundancies in information. It also decompresses files to play them back.

color bars A standard test signal that appears as a series of vertical rows of color by which the chrominance and video levels of a camera's output or a recorded signal can be checked.

color correction effect A Matrox effect that allows various color properties of an image to be adjusted. There are controls for adjusting the intensity level for hue, saturation, contrast, and brightness. The color correction effect can correct improper color levels of an image that are due to varying lighting conditions or incorrect camera settings. *See also* white balancing.

compile *See* render.

component video A video signal having separate channels for the video information, as opposed to a combined (composite) signal. Y, R-Y, B-Y video is a component video signal.

composite video A video signal containing luminance and chrominance information that has been combined using a video standard such as NTSC or PAL. Composite video often uses a single RCA or BNC cable connection. *See also* component video.

contrast The difference in brightness between the lightest and darkest areas of an image on the screen.

CPU-based effect An effect that takes advantage of your computer's CPU to play back in real time. The Matrox color correction effect is an example of a CPU-based effect. *Compare with* hardware-accelerated effect.

crawl Sideways movement of text across a screen. *See also* roll (1).

crossfade *See* dissolve.

cube effect A Matrox effect that lets you map video or graphics to the faces of 3D shapes such as cubes and slabs.

cut A direct switch from one video and/or audio source to another.

D

D-9 Originally known as Digital-S. A professional variant of the DV format developed by JVC that uses a data rate of 50 Mb/sec (5.96 MB/sec), which is double the data rate of most other DV formats. Video is sampled at 4:2:2 for both NTSC and PAL sources to give enhanced chroma resolution. It uses a 1/2" metal particle tape.

Digital8 A consumer camcorder video format developed by Sony. Digital8 camcorders use the DV format to record digital video and audio onto 8mm and Hi-8 tapes via any device that has an IEEE-1394 interface.

Digital-S *See* D-9.

digital signal A signal representing video or audio information as binary digits that can be easily regenerated with no noise or distortion. *See also* analog signal.

Digital Video *See* DV.

digitize To convert analog information, such as a video signal from a VTR or camera, into digital information that can be processed and stored by a computer.

Direct memory access (DMA) A technique used to rapidly transfer data between an attached device, such as a disk drive, and the computer's main memory without needing to pass the data through the central processing unit (CPU).

DirectX A Microsoft-developed program that enables interfaces to support advanced hardware features without being written specifically for each hardware model.

DirectShow (formerly called ActiveMovie) is part of DirectX.

display card A card that has its own memory and processor to handle graphics and enhance display capabilities. *Also called* graphics accelerator card *or* graphics card.

dissolve A transition in which one image smoothly fades to another image. It is characterized by the gradual ending of one image occurring simultaneously with the gradual beginning of another. *Also called* crossfade.

driver Software that controls a device, such as a display card, and enables it to work with other software.

drop-frame time code For NTSC video, time code is normally produced by a generator that counts at 30 frames per second. NTSC color signals, however, actually have a display frequency rate close to 29.97 frames per second. Drop-frame time code compensates for this time difference by dropping two frames from the count every minute except for every tenth minute so that the time code matches clock time.

DV Digital Video. A standard digital bit stream and compression format (known as the Blue Book standard) used to record video and audio onto a digital tape. DV is intra-frame based, saving each frame separately, and uses a fixed 5:1 compression ratio to reduce the size of video files. DV's data rate is fixed at 25 Mb/sec (2.98 MB/sec). Video is sampled at 4:1:1 for NTSC sources or 4:2:0 for PAL sources. *See also* DVCAM, DVCPRO, DVCPRO50, and D-9.

DVCAM A professional variant of the DV format developed by Sony that records a 15 micron track on a metal evaporated (ME) tape at a data rate of 25 Mb/sec (2.98 MB/sec). Video is sampled at 4:1:1 for NTSC sources or 4:2:0 for PAL sources.

DVCPRO A professional variant of the DV format developed by Panasonic that records an 18 micron track on metal particle tape at a data rate of 25 Mb/sec (2.98 MB/sec). Video is sampled at 4:1:1 for both NTSC and PAL sources.

DVCPRO50 A professional variant of the DV format developed by Panasonic that uses a data rate of 50 Mb/sec (5.96 MB/sec), which is double the data rate of most other DV formats. Video is sampled at 4:2:2 for both NTSC and PAL sources to give enhanced chroma resolution. It uses the same type of tape as DVCPRO.

DVD Digital Versatile Disc or Digital Video Disc. A type of compact disc that can hold from 4.7 gigabytes (GB) to 17 GB of information. The greatest advantage that DVD has over CD is that it can store video as well as audio and computer data. For video storage, DVD uses MPEG-2 compression, to provide better quality than standard VHS.

DVE Digital Video Effect. Generally, an effect that resizes and repositions a picture on the screen.

E

Edit Decision List (EDL) A file containing a list of edit decision statements used to create a video production.

edit master The first generation (original) of a final edited tape.

expansion slot Electrical connection slot mounted on a computer's motherboard (main circuit board). It allows several peripheral devices to be connected inside a computer. *See also* AGP slot and PCI slot.

F

fade to black A transition commonly used to signify the end of a scene, in which an image or sound smoothly fades to a black screen or silence (*also called* a fade-out transition). Similarly, you could start a new

scene with a fade up from black (or fade-in) transition.

field One-half of the horizontal lines needed to make a complete scan of an interlaced video frame. In the NTSC system, two consecutive fields of 262.5 lines each create a frame of 525 scan lines. In the PAL system, two consecutive fields of 312.5 lines each create a frame of 625 scan lines.

FireWire Apple Computer's original implementation of the technology that would be standardized as IEEE-1394 in 1995.

Flex 3D A fully programmable architecture that applies 3D texture mapping to video using a Matrox 3D graphics accelerator chip and graphics memory. *See also* texture mapping.

frame A single video image. An interlaced video frame is comprised of two consecutive fields (the odd and even fields).

G

graphics overlay Text or a graphics image that's superimposed on video. *Also called* super.

GOP Group of Pictures. The sequence of I, B and/or P-frames produced during MPEG or MPEG-2 compression. This sequence of frames contains all of the information required to reproduce a complete video segment. The longer the GOP, the less editable it is.

H

hardware-accelerated effect An effect that requires the assistance of dedicated hardware, such as Matrox RT.X100 Xtreme, to play back in real time. Matrox advanced DVE effects and page curls are examples of hardware-accelerated effects. *Compare with* CPU-based effect.

hue The tint or tone of a color. For example, the difference between the color green and red is its hue.

I

IBP compression *See* MPEG-2 IBP.

IEEE-1394 An international standard data transfer protocol created by Apple Computer under the FireWire trademark and standardized by the Institute of Electrical and Electronics Engineers (IEEE). It enables simple, low-cost, realtime data transfer between computers and consumer and prosumer electronics products, such as DV camcorders and DV decks. Commonly referred to as 1394.

I-frame compression *See* MPEG-2 I-frame.

I-frame (Intra-frame) A frame created during the MPEG or MPEG-2 compression process that contains all the information required to reproduce a complete image. It allows random access points within a video stream, and acts as a reference point for B-frames and P-frames to be built. I-frames are editable because they contain enough data to construct an entire video frame, unlike B-frames or P-frames.

insert editing Recording new video and/or audio material onto a prerecorded (or striped) tape. Insert edits can be made in any order, unlike assemble edits, which must be made sequentially.

inter-frame compression A video compression method that compares a series of frames in a video sequence and removes the redundant data. Inter-frame compression treats all the frames in the sequence as an interdependent group. As a result, most of the frames can't be edited independently. *Also called* temporal redundancy reduction. *Contrast with* intra-frame compression. *See also* GOP.

interlaced scanning A method of creating a video image by drawing only the odd numbered lines on the screen in one pass, then the even numbered lines in the next pass. Two passes are therefore required to create a complete frame of video. NTSC and PAL displays are interlaced. *See also* progressive scanning.

interleave A technique used to incorporate the video and audio portions of a video clip into one file. *See also* AVI.

interpolate To create a gradual transition between different Matrox effect settings applied to a clip. *See also* keyframe, linear interpolation, and spline interpolation.

intra-frame compression A video compression method that removes redundant information from within a frame. Intra-frame compression treats each frame of a video segment independently. Several video compression formats use the intra-frame method. These include Motion-JPEG, DV, and MPEG-2 I-frame. *Also called* spatial redundancy reduction. *Contrast with* inter-frame compression. *See also* I-frame (Intra-frame).

IRE unit An arbitrary unit designated by the Institute of Radio Engineers to define the amplitude of a video signal. 1 IRE is equal to approximately 7 mV.

J

JPEG (pronounced "jay-peg") Joint Photographic Experts Group. A compression and storage standard used for still, digital images. *See also* Motion-JPEG.

K

key effect *See* alpha key, chroma key, and luma key.

keyframe A particular frame at which one or more effect settings have been defined on a clip using the Matrox realtime plug-in. Settings applied at a keyframe remain active

on the clip until a later keyframe is defined to turn off or change the settings. *See also* interpolate.

L

LTC Longitudinal Time Code. Time code that is generally encoded as an audio signal onto a linear audio track of a tape. This type of time code can be read only while the tape is moving. *See also* VITC.

linear interpolation One of the two types of interpolation that can be set between consecutive keyframes using the Matrox realtime plug-in. Linear interpolation means that the transition between effect settings occurs in even, linear increments. *See also* spline interpolation.

luma key An effect that makes portions of a foreground image fully or partially transparent based on the luminance of that image, so that an underlying image can show through. *See also* alpha key and chroma key.

luminance The brightness portion of a video signal. The luminance of a pixel determines its brightness on a scale from black to white. *See also* chrominance.

luminance key *See* luma key.

M

mark in To select the first frame of a clip.

mark out To select the last frame of a clip.

mask DVE effect A Matrox effect that uses a moving grayscale pattern (matte) to superimpose one clip onto another. *Also called* traveling matte effect.

MIP mapping In 3D graphics, a rendering technique where a texture is stored at multiple resolutions. *See also* texture mapping.

M-JPEG *See* Motion-JPEG.

Motion-JPEG A compression and storage standard used for motion video. The JPEG

compression process is applied to each video field, in succession. *Also called* M-JPEG.

MP@ML Main Profile@Main Level. An MPEG-2 video compression profile that supports 4:2:0 luminance/chrominance sampling at up to 720×576 pixel resolution, and data transfer rates up to 15 Mb/sec (1.79 MB/sec). This profile is used for broadcast transmission and distribution on DVD. *See also* 4:2:2P@ML.

MPEG A video compression standard that specifies a series of compression profiles and image resolution levels, introduced in 1990 by the Motion Picture Experts Group. MPEG takes advantage of the redundancy inherent in video data through a combination of inter-frame and intra-frame redundancy reduction. The MPEG standard supports data transfer rates of up to 1.5 Mb/sec (0.2 MB/sec). *Also called* MPEG-1. *See also* MPEG-2, inter-frame (IBP) compression, and intra-frame (I-frame) compression.

MPEG-1 *See* MPEG.

MPEG-2 A video compression standard that improves upon the MPEG standard by supporting data rates of up to 100 Mb/sec (12 MB/sec), scalable modes, field or frame searching, and much larger screen sizes. *See also* intra-frame (I-frame) compression, inter-frame (IBP) compression, 4:2:2P@ML, and MP@ML.

MPEG-2 IBP An MPEG-2 compression type that uses inter-frame compression to create a group of I, B, and P-frames. Used for broadcast transmissions and distribution on DVD. *See also* GOP.

MPEG-2 I-frame An MPEG-2 compression type that uses only intra-frame compression (that is, only I-frames are created). Used for high-quality distribution and for archiving.

mV Abbreviation for millivolt (one-thousandth of a volt). Unit of measurement sometimes used to define the amplitude of a video signal. *See also* IRE unit.

N

nonlinear editing Random access editing that generally uses video and audio clips stored on disks. Nonlinear editing programs let you rearrange and edit clips without having to redo the entire production, and provide instant cueing to any frame in a clip without waiting for tapes to rewind.

NTSC National Television Systems Committee. The NTSC RS-170A standard defines a method of broadcasting a color signal that can be received by both monochrome and color TVs. It uses a composite interlaced display comprised of 525 scan lines per frame, refreshed at a rate of approximately 30 frames per second. Broadcast systems in North America and Japan use the NTSC standard.

O

organic wipe A wipe effect that uses a grayscale gradient pattern to switch from one image to another by gradually revealing the second image according to the pattern.

P

PAL Phase Alternate Line. A video standard that uses a composite interlaced display comprised of 625 scan lines per frame, refreshed at a rate of 25 frames per second. This is the broadcast video standard for most of Europe.

particle effect A Matrox effect in which a clip breaks apart or explodes in a number of patterns.

PCI slot Connection slot to a type of expansion bus found in most current computers. It is smaller in size than older ISA slots and provides connections to the high-speed PCI host bus.

P-frame (Predicted frame) A frame created during the MPEG or MPEG-2 IBP compression process. A P-frame is created by using motion vectors to predict the differences between it and the closest previous I-frame or P-frame. This forward prediction allows for higher compression than with I-frames, but not as high as with B-frames. P-frames, like B-frames, contain only predictive data and therefore cannot be edited independently.

pixel Picture element. The smallest portion of an image that can be written to a display. Each pixel in an image represents a single dot on the computer screen. A picture's resolution depends on the number of pixels on the screen.

Plug and Play A hardware standard for auto-configuration. It refers to the ability of computer hardware to detect and configure expansion devices such as your Matrox RT.X100 Xtreme card. Windows XP and Windows 2000 support Plug and Play.

plug-in Software that adds functionality and/or features to an application. For example, the Matrox realtime plug-in for Adobe Premiere adds realtime Matrox effects and transitions to Adobe Premiere. Plug-ins can be installed from a CD or downloaded from a web site.

proc amp An electronic device that adjusts the different aspects of a video signal, such as its hue, saturation, and contrast.

progressive scanning A method of creating a video image by drawing all the lines of a screen sequentially so that the complete image is displayed in one pass. VGA displays and some HDTV formats use progressive scanning.

R

realtime effect An effect that is played back instantly, without having to be rendered by an editing program.

render To compute an image or effect using a nonlinear editing, compositing, or animation program. The result is generally saved in a file on the computer. *Also called* compile.

RGB parade A specialized scope that displays the red, green, and blue components of a video signal.

RGB video A component video signal that uses three signals to carry the separate Red, Green, and Blue channels of colored images.

roll 1. Vertical movement of text across the screen. *Also called* scroll. *See also* crawl.
2. Unwanted vertical roll of a video image, indicating unstable sync.

RS-232 A non-differential serial data transmission standard used for computer connections. *See also* serial control.

RS-422 A differential serial data transmission standard that is often used for linking video production equipment (VTRs, mixers, etc.). Because this standard is differential, RS-422 connections are less subject to interference and noise than RS-232 connections. *See also* serial control.

S

saturation A measure of the depth of a color. Fully saturated colors are vivid, while colors that lack saturation look washed out or faded.

scroll *See* roll (1).

SECAM Séquentiel Couleur Avec Mémoire (sequential color with memory). A color television system developed in France and the former USSR. It uses a composite interlaced display comprised of 625 scan lines per frame, refreshed at a rate of 25 frames per

second. The color difference signals are transmitted sequentially on alternate lines. On Matrox RT.X100 Xtreme, SECAM can be used for video input only.

serial control A method of remotely controlling a device via a data line. The control data is transmitted in serial form (that is, one bit after another), such as for RS-232 and RS-422 connections.

setup *See* black level.

soft wipe A split screen or wipe effect with a soft border or edge where the two images join.

spatial redundancy reduction *See* intra-frame compression.

sphere effect A Matrox effect that morphs an image into spheres with shadow and highlight.

spline interpolation One of the two types of interpolation that can be set between consecutive keyframes using the Matrox realtime plug-in. Spline interpolation provides a smooth transition based on the settings of all keyframes. *See also* linear interpolation.

striping a tape Preparing a tape for editing by recording continuous control track, time code, and a video signal (such as black or color bars).

super *See* graphics overlay.

super black Video that is darker than the standard black level. *See also* super white.

super white Video that is brighter than the standard white level. *See also* super black.

SVCD Super Video CD. A standard for storing video and audio on a CD that provides better video quality than VCD and standard VHS. Video is compressed using MPEG-2 at 2500 Kbps, and audio is compressed as MPEG-1, layer II, at 224 Kbps. An SVCD

can hold about 30 minutes of material. Super Video CDs will play back on some DVD set-top players.

S-Video A component video signal in which the luminance (Y) and chrominance (C) information are separate. S-VHS videocassette recorders use the S-Video format. *Also called Y/C video.*

sync A circuit or signal that directs the electron gun in a camera or TV picture tube to hold a picture steady on the screen. It also synchronizes the electronics of other video equipment.

sync generator An electrical device that generates sync (timing) signals used to synchronize video equipment and keep pictures stable on the screen.

T

TBC *See* time base corrector.

temporal redundancy reduction *See* inter-frame compression.

texture mapping A display technique where bitmaps (textures) are placed (mapped) onto 3D surfaces to make objects look more realistic.

tile A transition in which one image is gradually replaced by another image that appears part-by-part in successive squares. The squares follow a given pattern until the entire screen is filled with the new image.

time base corrector (TBC) An electronic device that, when connected to the output of a VTR, corrects the stability and timing of the VTR's playback video. This is achieved by stripping the unstable horizontal and vertical sync pulses from the video signal, and replacing them with new, clean sync pulses.

time code A sequential code number assigned to successive video frames on tape. Each frame has its own time code, which is

electronically encoded on the tape in the form hours:minutes:seconds:frames. *See also* drop-frame time code, LTC, and VITC.

timeline The graphical representation (normally a horizontal line) of a video sequence. It is usually divided into hours:minutes:seconds:frames, and is used to position video, audio, graphics, and video effects that make up the sequence.

tonal range The range of light and dark areas in an image. Tonal range can be divided into three different areas: shadows, midtones, and highlights. Shadows are the darkest areas of an image, highlights are the lightest areas, and midtones are the areas with tones between the lightest and darkest areas.

transform settings Settings that let you change the position, size, and rotation of a clip in the Matrox realtime plug-in. Transform settings can be applied on the x, y, and z axes of a clip. *See also* keyframe.

traveling matte effect *See* mask DVE effect.

V

VCD Video CD. A standard for storing video and audio on a CD that provides slightly better video quality than standard VHS. Video is compressed using MPEG-1 at 1100 Kbps, and audio is compressed as MPEG-1, layer II, at 224 Kbps. A VCD can hold about 60 minutes of material. Video CDs can play back on most DVD set-top players. *See also* SVCD.

vectorscope A device that measures the phase and amplitude of the color components of a video signal.

VITC Vertical Interval Time Code. Time code that is encoded onto the vertical blanking interval of a video signal. VITC can be read by a VTR whenever an image is displayed, but not usually during high-speed operation. *See also* LTC.

voice over Narration added to a video segment and mixed in louder than the original background sounds.

W

WAV An audio data file format developed by Microsoft and IBM. This format is the standard for Windows and can be played by most applications that can support sound.

white balancing A color correction technique that adjusts the color levels of an image using white or gray as a color reference point. White balancing assumes that when a white object can be made to look white, the other color levels will also be accurate. White balancing is used to correct improper color levels of an image that are due to varying lighting conditions or incorrect camera settings. White balancing is available using the Matrox color correction effect, and also as a setting on most cameras.

white level The brightest “legal” level of a video signal (reference white), which is at 100 IRE. *See also* black level, super black, and super white.

wipe A transition in which one image is gradually replaced by another image that is revealed in a given pattern. For example, the second image could be revealed from the top of the screen downwards until it fills the entire screen. *See also* organic wipe.

X

x-y-z coordinate system A 3D positioning system that includes a third (z) axis running perpendicular to the horizontal (x) and vertical (y) axes. The x-y-z coordinate system is used in computer graphics for creating models with height, width, and depth, and for moving models in 3D space.

Y

Y waveform A specialized scope that displays the luminance (Y) values of a video signal.

Y/C video *See* S-Video.

YC waveform A specialized scope that displays the combined luminance (Y) and chrominance (C) of a video signal.

Y, R-Y, B-Y video An analog component video signal comprised of three channels: Y (luminance), R-Y (red minus luminance), and B-Y (blue minus luminance).

Your notes

D

RT.X100 Xtreme Customer Support

This appendix explains how to reach us if you need customer support.

Getting the most support

If you have a problem that you're unable to solve by referring to your RT.X100 Xtreme documentation, please contact your Matrox RT.X100 Xtreme representative. He or she should be able to help you quickly correct any installation or system configuration problem.

If your representative is unable to solve your problem, contact Matrox for further information and assistance.

Register your RT.X100 Xtreme

Only customers who've registered their RT.X100 Xtreme are eligible to receive customer support service by phone. You can register your RT.X100 Xtreme online by choosing **Register your RT.X product** from the Matrox RT.X menu once you've installed Matrox X.tools as explained on [page 35](#). You can also register in the RT.X Support section of our web site at www.matrox.com/videweb/support.

Registering your RT.X100 Xtreme entitles you to free software updates, special promotional offers, and access to the Matrox RT.X100 Xtreme User Forum, our dynamic web forum for users who want to share their experiences and learn more about RT.X100 Xtreme. As a registered Matrox RT.X100 Xtreme user, you'll have full access to fxzone.matrox.com, where you can share realtime effects and download new effects, and www.matrox.tv, where you can post your streaming video clips for free.

Keep up to date with our web site

In addition to registering your RT.X100 Xtreme, our web site offers you up-to-the-minute information about Matrox products, free software updates, access to our support databases, and a complete list of computer equipment compatible with Matrox RT.X100 Xtreme. Be sure to place our site in your favorites or bookmarks: www.matrox.com/videweb/support.

Contacting us

Matrox is proud to offer worldwide customer support. Please use the contact information for your area.



Note The following numbers are subject to change. For up-to-date contact information, always check our web site at www.matrox.com/videoweb/support.

United States & Canada

Telephone 1 514 822-6030
Fax..... 1 514 685-2853
Email RT.X100support@matrox.com

Europe, Middle East, & Africa

Telephone

Calls from the U.K..... 01753 665686
Calls from France..... +33 01 45 60 88 66
Calls from Germany..... +49 (0) 89 621 70 570
Calls from Italy 02 5253098
Calls from the rest of Europe, the Middle East, & Africa +44 1753 665686

Fax

From the U.K..... 01753 665599
From Italy 02 52534045
From the rest of Europe, Middle East, & Africa +44 1753 665599

Email

From Italy supporto.rt@treg.it
From the rest of Europe, the Middle East,
& Africa..... RT.X100.tech.europe@matrox.com

All other countries

Telephone 1 514 822-6030
Fax..... 1 514 685-2853
Email RT.X100support@matrox.com

Your notes



Matrox Around the World

This appendix provides contact information for Matrox sales offices around the world.

Worldwide Headquarters

Matrox Electronic Systems Ltd., Video Products Group

1055 St. Regis Blvd.
Dorval, Quebec
Canada, H9P 2T4
tel: 1 800 361-4903 (North America)
514 685-2630 ext. 2036 (Worldwide)
fax: 514 685-2853
Email: video.info@matrox.com

Europe, Middle East, Africa

Matrox Video and Imaging Technology Europe

Sefton Park
Stoke Poges
Buckinghamshire
SL2 4JS
United Kingdom
tel: +44 (0) 1753 665577
fax: +44 (0) 1753 665599
Email: video.info.emea@matrox.com

France

Matrox France SARL

2, rue de la Couture
Silic 225
94528 Rungis Cedex
France
tel: +33 (0) 1 45 60 62 08
fax: +33 (0) 1 45 60 88 65
Email: infovideo.br@matrox.com

Germany

Matrox Electronic Systems GmbH

Inselkammerstraße 8
D-82008 Unterhaching bei
München, Germany
tel: +49 (0) 89 621 70 570
fax: +49 (0) 89 614 97 43
Email: video.info.emea@matrox.com

Asia Pacific

Matrox Asia Liaison Beijing Representative Office

#1608, 138A Haidian Road
Beijing, China 100086
tel: (86-10) 6256 4853
fax: (86-10) 6253 6251
Email: myang@matrox.com



Note The above information is subject to change. For up-to-date contact information, always check our web site at www.matrox.com/video.

Numerics

- 1394 connector
 - connecting DV camera to 26
- 3D tile
 - applying a pre-created 91
 - creating a custom 92
 - placing to avoid rendering 81
- 3ds max plug-in
 - about 236
 - installing 36
 - required settings 236

A

- A/B mode preview
 - definition 170
- A/V drives
 - defragmenting 11
 - EIDE considerations 9
 - export drive 9
 - formatting as NTFS 10
 - general considerations 8
 - planning EIDE connections 9
 - planning setup of 8
 - space for audio 266
 - space for video 266
- Adaptive degradation
 - definition 169
- Adobe After Effects plug-in
 - about 232
 - installing 36
 - required settings 232
- Adobe Photoshop LE
 - using to create mask DVE patterns 133
 - using to create organic wipe patterns 137
- Adobe Premiere
 - Audio settings 54
 - Capture settings 55
 - Export Frame settings 64
 - Export Movie settings 64
 - exporting clips from MediaTools 205
 - exporting material for DVD 241
 - exporting Timeline to DV tape 71
 - exporting to disk in real time 65
 - General settings 43
 - installing 14
 - loading Matrox project presets 42
 - MediaExport plug-in 210
 - selecting realtime Premiere transitions 52
 - setting up DV-1394 device control 69
 - setting up scratch disks 42
 - troubleshooting 255
 - using DV-1394 devices with 76
 - Video settings 54
 - See also* Realtime plug-in for Adobe Premiere
- Advanced DVE
 - applying a pre-created 94
 - creating a custom 96
 - placing to avoid rendering 81
- Aspect ratio
 - See* Editing aspect ratio
- Audio Capture Drift Detection test
 - running 62
- Audio sampling
 - disk space requirements 266
- Audio settings
 - for Adobe Premiere 54
 - recording and playback volume controls 13
 - troubleshooting 263
- Audio specifications
 - RT.X100 Xtreme card 270
- AVI files
 - capturing using Adobe Premiere 55
 - capturing using VFW programs 176, 180
 - creating using MediaTools 186, 196, 197, 198, 200, 204
 - exporting using Adobe Premiere 64
 - exporting using Matrox Realtime Export to Disk 65
 - rendering using VFW programs 176, 179
 - VFW
 - capturing video with audio 183

B

Basic DVE

- applying a pre-created 98
- creating a custom 99
- placing to avoid rendering 81

Blur effect

- applying a pre-created 100
- creating a custom 101
- placing to avoid rendering 81

Breakout cable

- connecting 20

C

Capture folder

- selecting in MediaTools 194

Capturing using Adobe Premiere

- specifying settings for 55
- troubleshooting 261

Capturing using MediaTools

- batch capturing 198–200
- capturing individual clips from tape 197
- capturing live video 197
- creating a batch capture list 198
- preparing tapes for 186
- scanning and capturing 196
- specifying settings for 194

Capturing using VFW programs 176

- before you start 180
- capture format and resolution, selecting 182
- procamps, adjusting 180
- source, selecting 180

Card installation

- before you begin 8
- inserting card 19

CD-R 240

- recommended data rates 267

Chroma filtering and chroma interpolation

- for rendering in Adobe Premiere 48
- for rendering to VFW files 179

Chroma key effect

- creating 103
- overview 102

- placing to avoid rendering 81

- viewing and selecting key colors 105

Chroma sampling for fast-motion video

- for rendering in Adobe Premiere 49
- for rendering to VFW files 179

Codec

- Matrox DV/DV CAM 179
- RealMedia video 217
- Windows Media audio 219
- Windows Media video 219

Color bars

- calibrating video with Matrox scopes 61, 113

Color correction

- applying a pre-created 107
- creating a custom 108
- placing to avoid rendering 81
- using the Matrox scopes 110

Color space conversion options

- for rendering in Adobe Premiere 48
- for rendering to VFW files 178

Colorization effect

- applying a pre-created 116
- creating a custom 117
- placing to avoid rendering 81

Composite video device

- as source in Adobe Premiere 56
- available connections 27
- connecting recorder 29
- connecting source 28
- typical connections 25

Compressor

- selecting for VFW render 179

Computer

- storage considerations 8, 9
- system requirements 4

Configuring

- WYSIWYG DirectShow Control Panel 249
- your sound card 13
- your Windows 2000 display 12
- your Windows XP display 12

- Connections
 - breakout cable 20
 - composite video 27, 28
 - computer speakers 20
 - DV-1394 26
 - EIDE devices 9
 - S-Video 27, 30
 - typical audio and video 23
- CPU usage
 - monitoring 173
- Crop track
 - crop settings 153
- Cropping
 - default setting for Matrox effects 52
 - source video, MediaExport 212
- Cropping a clip
 - using the crop controls 155
 - using the crop menu 155
 - using the Cropping Window 154
 - using the Preview Window 156
- Cube effect
 - applying a pre-created 119
 - creating a custom 121
 - placing to avoid rendering 81
- Custom tracks
 - common controls 87
 - saving effects 87
- Customer support iii, 284
 - getting updated information 252
- D**
- Data rates and disk space 266
- Default Matrox effect
 - specifying 86
- DirectShow programs
 - displaying clips on video monitor 248
- Disk defragmentation 11, 255, 258
- Disk space requirements
 - for audio 266
 - for video 266
- Display
 - configuring your Windows 2000 display 12
 - configuring your Windows XP display 12
- Distortion effect
 - placing to avoid rendering 81
- Dropped frames in realtime effects
 - adaptive degradation with
 - XtremePreview 169
 - identified on Timeline 44
 - monitoring CPU usage 173
 - reporting 44
 - troubleshooting 255
- DV-1394 device
 - as source in Adobe Premiere 56
 - connecting 26
 - seek method 69, 195
 - settings in Adobe Premiere 50
 - typical connections 23
 - using with Adobe Premiere 76
- DV-1394 device control
 - setting up in Adobe Premiere 69
- DVD drive
 - enabling DMA 264
- DVD formats
 - DVD discs 240
 - DVD volumes 240
- DVD player
 - software DVD player 240, 245
 - troubleshooting 264
- DVD volume
 - creating 243
 - playing 245
- DVDIt! SE
 - creating a DVD volume 243
 - displaying project on video monitor 248
 - exporting material from Adobe
 - Premiere 241
 - installing 38
 - overview 240
 - playing a DVD volume 245
- DVD-R 240
 - recommended data rates 267
- DVL files
 - saving and loading 202

E

- Editing aspect ratio
 - creating production in 16:9 format 77
 - selecting 43, 46
- Effect tracks
 - resetting to default settings 159
 - tooggling state for preview 88
- EIDE devices
 - storage considerations 9
- Encoding
 - for the web using MediaExport 210
 - MPEG video using Matrox Realtime Export to Disk 66, 241
 - MPEG video using MediaExport 210
 - profiles in MediaExport 213
- Environmental specifications
 - RT.X100 Xtreme card 270
- Error reporting
 - for dropped frames during video playback 44
- Exporting
 - clips from MediaTools to Adobe Premiere 205
 - Matrox clips in Adobe Premiere 64, 65
 - to DV tape using Adobe Premiere 71
 - troubleshooting 262
 - using Matrox Realtime Export to Disk 65, 241
 - using MediaExport 212

F

- Force render option 86

G

- General specifications
 - RT.X100 Xtreme card 270
- Glossary 272
- Graphics clips
 - placing to avoid rendering 82
 - supported formats 170
- Graphics overlays
 - setting up in Adobe Premiere 167

H

- Hard drive performance 9
- Hardware
 - supplied with Matrox RT.X100 Xtreme 3

I

- Installation
 - Adobe Premiere 14
 - Matrox RT.X100 Xtreme card 18
 - Matrox X.tools 35
 - overview 6
 - preparing your system for 8
 - software from RT.X menu 36
 - Sonic DVDIt! SE 38
 - Sonic ReelDVD Studio 38
 - third-party software 14
 - troubleshooting 253
- Internet
 - Matrox WWW site 284

K

- Keyboard shortcuts
 - for Adobe Premiere realtime plug-in 166
 - for MediaTools 206
- Keyframes
 - copying and moving 160
 - creating new 159
 - creating outside clip region 164
 - deleting 162
 - interpolating between 163, 165
 - keyboard shortcuts for working with 166
 - linear interpolation 164
 - modifying 159
 - pasting attributes of 161
 - saving and loading 162
 - selecting 160
 - spline interpolation 164
 - using keyframe controls 157
 - working with 157
- KFT files
 - saving and loading 162

L

- Legal colors
 - ensuring with Matrox scopes 114
- License agreement [iv](#)
- LightWave 3D plug-in
 - about 238
 - installing 36
 - required settings 238
- Ligos
 - compliant settings 226
 - encoding MPEG files 210
- Luma key effect
 - creating 125
 - overview 124
 - placing to avoid rendering 81
 - viewing and selecting luminance values 127
- Luminance range settings
 - for rendering to VFW files 178

M

- M2V files
 - capturing using Adobe Premiere 55
 - exporting using Matrox Realtime Export to Disk 65, 241
 - exporting using MediaExport 222
- Mask DVE effect
 - adding your own patterns 132
 - applying a pre-created 129
 - creating a custom 131
 - placing to avoid rendering 81
- Matrox
 - contacting us 285, 287
 - sales offices 287
 - WWW site 284
- Matrox DV/DVCAM codec
 - selecting for VFW render 179
- Matrox DV-1394 Device Control
 - setting 69
- Matrox Effect add-ons
 - installing 36
- Matrox MediaExport
 - about 210
- adding
 - clip information 215
 - customized profiles to profile library 228
 - encoding profiles to session window 213, 214
 - target audiences to an encoding profile 221
- audio
 - bit rate, Ligos MPEG 225
 - codec, Windows Media 219
- bit rate
 - settings, Ligos MPEG 225
- clip information 215
- codec options
 - RealMedia 217
 - Windows Media 219
- cropping source video 212
- customizing profiles 215
- Destination box 212
- Destination button 212
- dialog box 211
- encoding profiles
 - copying 216
 - customizing 215, 216
 - export settings 214, 215
 - selecting 213
 - standard 213
- encoding session
 - saving and loading 229
- exporting clips from the Timeline 212
- output files 216
- pop-up menu 212
- profile library
 - adding customized profiles 228
 - customizing profiles 215
 - selecting standard profiles 213
- removing profiles from session window 215
- saving/loading encoding sessions 229
- selecting encoding profiles 213
- session window 211
- settings
 - export 215
 - Ligos MPEG bit rate 225

- Ligos MPEG common 222
- Ligos MPEG GOP structure and motion vector 223
- Ligos-compliant settings 226
- RealMedia codec options 217
- target audience 220
- Windows Media codec options 219
- starting MediaExport 210
- target audience
 - settings 220
- video
 - codec, RealMedia 217
 - codec, Windows Media 219
 - Ligos MPEG 222
- work area only 211
- Matrox MediaTools
 - about 186
 - batch capturing clips 198–200
 - CAM button 188
 - capturing individual clips from tape 197
 - capturing live video 197
 - changing In/Out icons 201
 - clip ID and clip names 196
 - clip list 201
 - adding clips 201
 - copying clips 202
 - deleting clips 203
 - detaching and resizing 203
 - moving clips 202
 - saving and loading 202
 - creating a batch capture list 198
 - defining capture settings 194
 - Disk button 188, 190
 - editing clips 200
 - grabbing a single-frame image 204
 - keyboard shortcuts 206
 - marking In/Out points 191
 - pop-up menu 190
 - preparing your tapes 186
 - recapturing clips 200
 - scanning and capturing clips 196
 - scanning clips 198
 - seek method 195
 - starting 187
 - time code fields
 - editing 192
 - marking In/Out points 191
 - time code display 192
 - transport controls 190
 - using the MediaTools interface 188
 - VTR button 188, 190
- Matrox Realtime Export to Disk
 - performing 65
- Matrox RT.X100 Xtreme
 - card installation 18
 - connecting to breakout cable 20
 - features 2
 - glossary 272
 - hardware supplied 3
 - installation overview 6
 - software supplied 3
 - storage considerations 8, 9
 - system requirements 4
- Matrox scopes 59, 110
 - calibrating video using color bars 61, 113
 - ensuring legal colors 114
 - matching colors 115
 - RGB parade
 - definition 61, 113
 - selecting and viewing 59, 111
 - vectorscope
 - definition 60, 112
 - Y waveform
 - definition 61, 112
 - YC waveform
 - definition 61, 112
- Matrox VFW software codecs
 - installing 37
- Matrox X.tools
 - installing 35
 - registering your product 36
 - removing 38
- MediaExport
 - See* Matrox MediaExport

MediaTools
See Matrox MediaTools

MEX files
 saving and loading 229

MPA files
 exporting using MediaExport 222

MPEG data rates
 recommended for DVD-R or CD-R 267

MPEG, Ligos
 encoding 210

MPEG-1 Elementary files
 exporting using MediaExport 222

MPEG-1 Program files
 exporting using MediaExport 222

MPEG-2 Elementary files
 capturing using Adobe Premiere 55
 exporting using Matrox Realtime Export to Disk 65, 241
 exporting using MediaExport 222

MPEG-2 IBP settings
 selecting in Adobe Premiere 67

MPEG-2 Program files
 exporting using MediaExport 222

MPG files
 exporting using MediaExport 222

N

NTFS
 formatting drives as 10

NTSC setup level
 selecting for analog video 43, 44

O

Organic wipe
 adding your own patterns 136
 applying a pre-created 134
 creating a custom 135
 placing to avoid rendering 81

P

Page curl
 applying a pre-created 138
 creating a custom 139

placing to avoid rendering 81

Particle effect
 applying a pre-created 141
 creating a custom 143
 placing to avoid rendering 81

PC-based DVD player
See DVD player

Proc amps
 adjusting before capturing analog video 58
 adjusting using Matrox color correction 108
 checking adjustments in vectorscope 61, 113

Project presets
 loading for Matrox RT.X100 Xtreme 42

R

RealMedia
 encoding 210

Realtime export to disk 65

Realtime plug-in for Adobe Premiere
 3D tile
 applying a pre-created 91
 creating a custom 92

advanced DVE
 applying a pre-created 94
 creating a custom 96

applying a Matrox transition 83

applying a Matrox video effect 83

available effects 80

basic DVE
 applying a pre-created 98
 creating a custom 99

blur effect
 applying a pre-created 100
 creating a custom 101

chroma key effect
 creating 103
 overview 102

color correction
 applying a pre-created 107
 creating a custom 108
 using the Matrox scopes 110

color selection 90

- colorization effect
 - applying a pre-created 116
 - creating a custom 117
- common controls 84
- common controls on the Custom pages 87
- copying and moving keyframes 160
- creating keyframes 159
- cube effect
 - applying a pre-created 119
 - creating a custom 121
- default crop settings 52
- default Matrox effect 86
- deleting keyframes 162
- dropped frames in realtime effects 173, 255
- forcing Matrox effects to render 86
- graphics overlays 167
- interpolating between keyframes 163, 165
- keyboard shortcuts 166
- linear interpolation 164
- luma key effect
 - creating 125
 - overview 124
- mask DVE effect
 - adding your own patterns 132
 - applying a pre-created 129
 - creating a custom 131
- modifying keyframes 159
- monitoring CPU usage 173
- organic wipe
 - adding your own patterns 136
 - applying a pre-created 134
 - creating a custom 135
- page curl
 - applying a pre-created 138
 - creating a custom 139
- particle effect
 - applying a pre-created 141
 - creating a custom 143
- pasting keyframe attributes 161
- performing a realtime export to disk 65
- placing effects to avoid rendering 81
- previewing effects 88
- realtime rules 170
- resetting a track to default settings 159
- saving custom effects 87
- saving/loading keyframes 162
- selecting keyframes 160
- selecting realtime Premiere transitions 52
- sliders and text boxes 89
- sphere effect
 - applying a pre-created 146
 - creating a custom 147
- spline interpolation 164
- undoing and redoing changes 89
- using keyframe controls 157
- using the Crop track 153
- using the Transform track 149
- working with keyframes 157
- ReelDVD Studio
 - installing 38
- Registering your product 36
- Rendering using Adobe Premiere
 - forcing Matrox effects to render 86
 - selecting color space conversion options 48
 - selecting MPEG-2 IBP settings 67
 - when you'll need to render 172
- Rendering using VFW programs
 - before you start 177
 - selecting color space conversion options 178
 - selecting compressor 179
- Reporting dropped frames
 - during video playback 44
- RGB parade
 - definition 61, 113
 - matching colors 115
- RT.X User Forum 284
- RT.X100 Xtreme breakout cable
 - See* Breakout cable
- RT.X100 Xtreme card
 - audio specifications 270
 - connecting to breakout cable 20
 - environmental specifications 270
 - general specifications 270
 - installation 18
 - video specifications 270

S

- Sales offices 287
- Scrubbing types
 - switching between 46
- Seek method
 - selecting in Adobe Premiere 69
 - selecting in MediaTools 195
- Service
 - returns iii
- Setup level
 - selecting for NTSC analog video 43, 44
- Software
 - license agreement iv
 - supplied with Matrox RT.X100 Xtreme 3
- Software installation
 - 3ds max plug-in 36
 - Adobe After Effects plug-in 36
 - LightWave 3D plug-in 36, 37
 - Matrox Effect add-ons 36
 - Matrox VFW software codecs 37
 - Matrox X.tools 35
 - overview 34
 - Sonic DVDit! SE 38
 - Sonic ReelDVD Studio 38
- Solo mode preview 88
 - automatic solo mode 169
- Sonic DVDit! SE
 - See DVDit! SE
- Sonic ReelDVD Studio
 - installing 38
- Sound card
 - audio connections 20
 - configuring 13
 - recording and playback volume controls 13
- Speakers
 - connecting 20
- Speed control method
 - selecting 47
- Sphere effect
 - applying a pre-created 146
 - creating a custom 147
 - placing to avoid rendering 81

- Storage considerations
 - A/V drives 9
 - disk defragmentation 11
 - EIDE 9
 - general 8
 - Style conventions 5
 - S-Video device
 - as source in Adobe Premiere 56
 - available connections 27
 - connecting recorder 31
 - connecting source 30
 - typical connections 24
 - System requirements 4
- T**
- Tapes
 - preparing for export to DV tape with Adobe Premiere 71
 - preparing for use with MediaTools 186
 - Technical support
 - See Customer support 284
 - TGA files
 - creating using MediaTools 204
 - Titles
 - placing to avoid rendering 81
 - setting up in Adobe Premiere 167
 - supported formats 170
 - Transform track
 - transform settings 149
 - Transforming a clip
 - using the Preview Window 152
 - using the transform controls 150
 - using the Transform menu 151
 - Transitions
 - applying realtime 83
 - selecting realtime Adobe Premiere 52
 - specifying default 86
 - Troubleshooting 251
 - Adobe Premiere 255
 - audio issues 263
 - capture issues 261
 - DVD/CD authoring 264

- export issues 262
- getting updated information 252
- installation/configuration 253

V

- Vectorscope
 - calibrating video using color bars 61, 113
 - definition 60, 112
- Video effects
 - applying realtime 83
 - applying to graphics 83
 - specifying default 86
- Video for Windows programs 176
 - capturing clips 176, 180
 - rendering Matrox AVI file 179
 - Video Format command 182
 - Video Source command 180
- Video for Windows software codecs
 - installing 37
- Video preview during 1394 export to tape
 - enabling/disabling on computer monitor 50
- Video quality
 - disk space requirements 266
 - dropping frames 255
 - selecting in Adobe Premiere 68
- Video specifications
 - RT.X100 Xtreme card 270
- Volume controls
 - recording and playback settings 13

W

- Warranty ii
- WAV files
 - captured audio in Adobe Premiere 51
 - captured audio in MediaTools 194
 - exporting using Adobe Premiere 66
 - exporting using MediaExport 222
- Widescreen format
 - editing material on Matrox RT.X100 Xtreme 77
- Windows 2000
 - installing 11

- Windows Media
 - encoding 210
- Windows Media Player
 - displaying clips on video monitor 248
- Windows XP
 - installing 11
- WWW site 284
- WYSIWYG DirectShow Control Panel
 - configuring 249
 - overview 248

X

- X.tools
 - See* Matrox X.tools
- XtremePreview
 - definition 169
 - enabling 50

Y

- Y waveform
 - calibrating video using color bars 61, 113
 - definition 61, 112
- YC waveform
 - definition 61, 112
 - ensuring legal colors 114