

VIASYN™
The CompuPro People

DISK 3™

TECHNICAL MANUAL

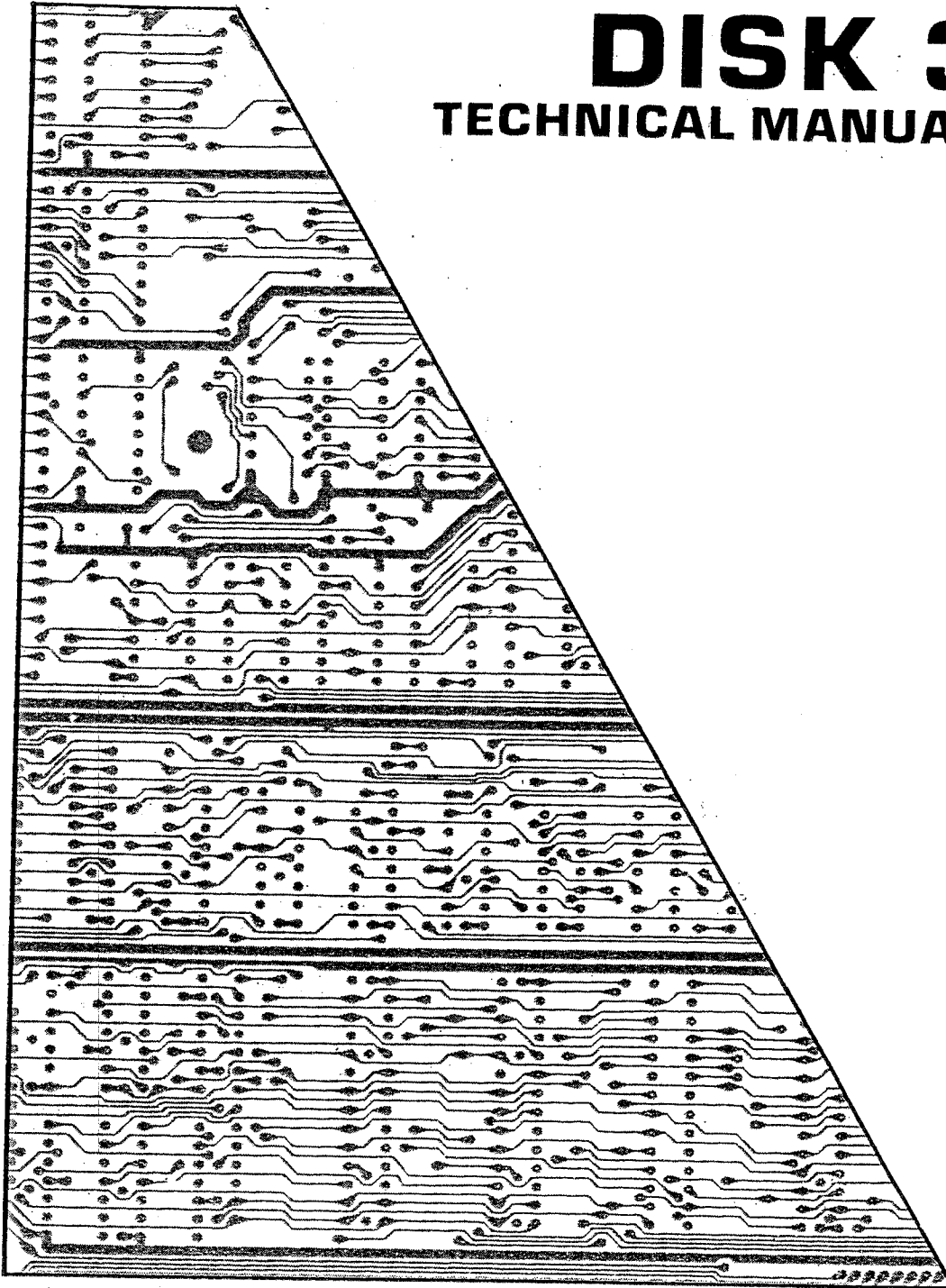

\$20.00

DISK 3 TECHNICAL MANUAL

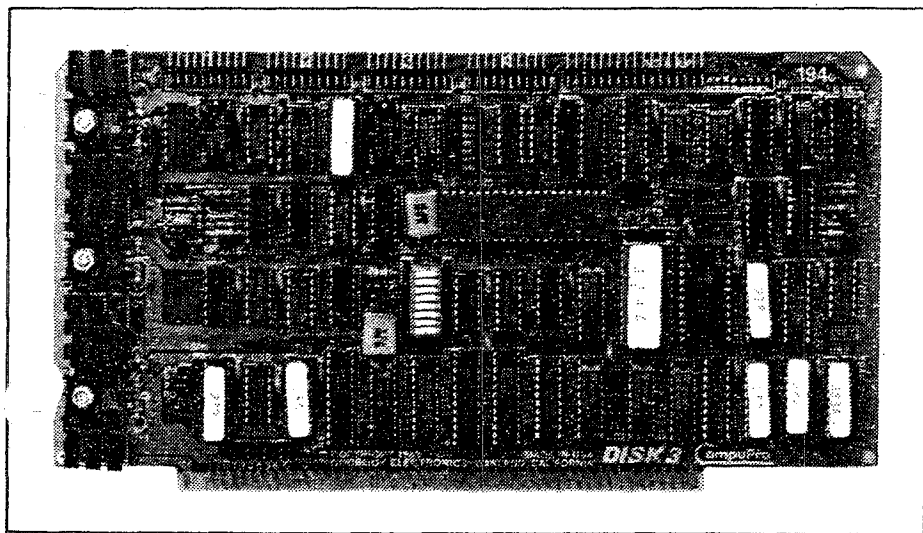

HARD DISK CONTROLLER
FOR ST-506 COMPATIBLE DRIVES

DISK 3 TECHNICAL MANUAL
Copyright 1983, 1984, 1985 Viasyn Corporation
Hayward, CA 94545

File name: DISK3.MAN
Part No. 8261-0090
Board No. 194, Revision G

First edition: October 1983
Latest edition: May 1985

DISCLAIMER - Viasyn Corporation makes no representations or warranties with respect to the contents hereof and specifically disclaims any implied warranties of merchantability or fitness for any particular purpose. Further, VIASYN reserves the right to revise this publication and to make any changes from time to time in the content hereof without obligation of VIASYN to notify any person of such revision or changes.

Registered Trademarks: CompuPro, Viasyn Corporation. CP/M, CP/M-86, Digital Research, Inc.

Compound Trademarks: CP/M 8-16, MP/M 8-16, Concurrent DOS 8-16, Digital Research, Inc. and Viasyn Corporation.

Trademarks: DISK 3, Viasyn Corporation. CP/M 68K, Digital Research, Inc.

All rights reserved. No part of this publication may be reproduced or transmitted in any form, or by any means, without the written permission of VIASYN. Printed and assembled in U.S.A.

CONTENTS

How to get your DISK 3 up and running	
Installation procedures1-6
Testing6-8
Troubleshooting9
DISK 3 Technical Information	
Introduction10
Hardware interface10
Software overview11
Software interface11
Specify format18-19
Appendix19-20
Hardware Section	
Logic diagram22-25
Parts list26
Component layout27

NOTICE

The DISK 3's D revision firmware (U32) has several performance enhancements that require the following:

1) Operating systems, or higher versions, as listed below:

CP/M® 2.2Q
CP/M 8-16™ 1.1R
CP/M-86® 1.1R
MP/M™ 8-16™ 2.11
Concurrent DOS™ 8-16™ 3.1D
CP/M 68K™ 1.2M

If your operating system is older than those listed, it should be upgraded.

2) Hard disks must be formatted with the interleave factors (skew) shown below:

Sector size:	Interleave
2048	2
1024	2 - CompuPro standard
512	3
256	3

3) DISK 1A (if present) should have EPROM #291B or greater.

DISK 3 SPECIFICATIONS

Timing Meets all IEEE 696/S-100 timing specifications.
DMA Fully arbitrated 24-bit extended addressing temporary master per IEEE 696/S-100 specifications. No restrictions at 64K boundaries.
Priority Level Switch selectable.
Memory Requirements None.
Port Requirements Two ports, switch selectable address.
Interrupts Completion interrupt enabled by software. Priority level jumperable to VI0-VI7 or INT.

ST506 compatible version characterized by:

Disk Data Rate 5.0 MBPS
Control Cable 34 Conductor
Data Drivers RS422

Drive Characteristics and Format:

The DISK 3 maintains a separate table of characteristics for each of the connected drives. Tables are loaded through channel commands making each of the drives independently software configurable. The software configurable parameters include:

Step Rate Drive Dependent.
Head Settle Time Drive Dependent.
Number of Heads Drive Dependent (Up to 16)
Number of Tracks Drive Dependent (Up to 64K)
Precomp Drive Dependent (Any track)
Low Current Drive Dependent (Any track)
Sector Size Drive Dependent (128, 256, 512, 1024 or 2048 bytes)
Sectors Per Track Drive Dependent (Up to 56)

HOW TO GET YOUR DISK 3 UP AND RUNNING

Eager to get your new DISK 3 running? Careful installation is needed to assure proper function of this board.

DISK 3 INSTALLATION PROCEDURES (For use with CompuPro® Hard Disk Subsystems.)

STEP 1. UNPACK DISK 3 BOARD.

Along with the board, you will find an extra jumper shunt and two card ears in the plastic bag.

STEP 2. INSTALL CARD EARS.

- a) Hold the board so the component side is toward you. (See diagram below.)
- b) Insert the peg on the card ear into the hole in the right corner of the board. Fold the ear over the board's edge until the ear's hole snaps over the peg (make sure the long edge of the ear is along the top edge of the board.)
- c) Repeat for left ear.

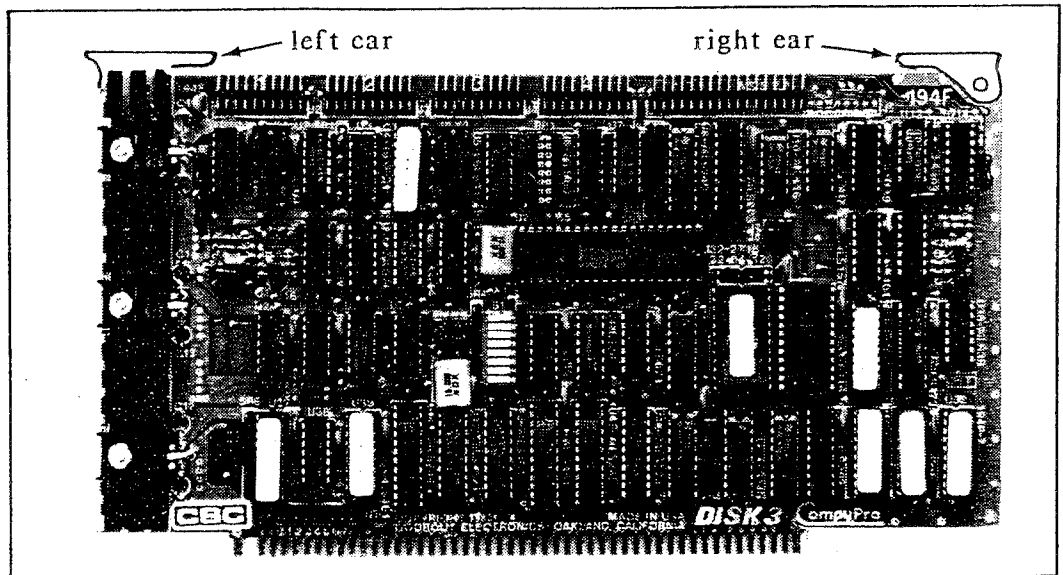
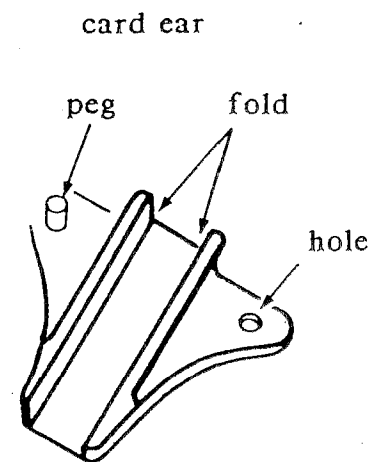
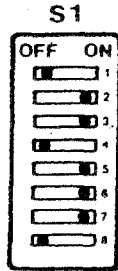

Figure 1. DISK 3 (Component Side)

STEP 3. SET SWITCHES. Check the DISK 3 switch settings (see figure below for the location of S1. We recommend that switch positions which are NOT USED be set to OFF.

The black dot (●) shows which side of the switch should be down.

SWITCH 1:



	<u>POSITION</u>	<u>SET IT</u>
1	OFF
2	ON
3	ON
4	OFF
5	ON
6	ON
7	ON
8	(NOT USED)

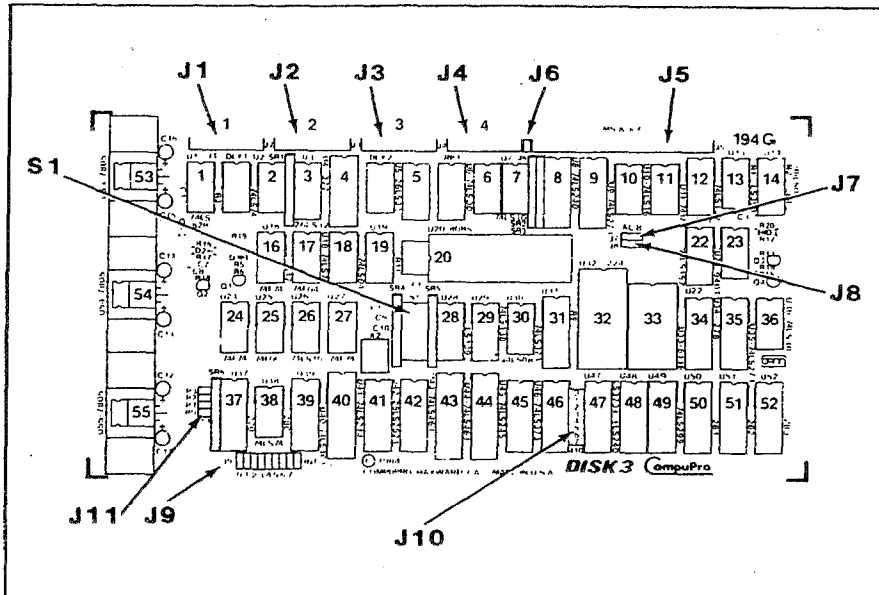
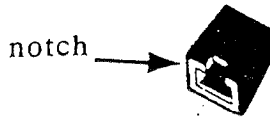

Figure 2. DISK 3 (jumper and switch location)

STEP 4. CHECK JUMPER SHUNT CONNECTORS

Make sure the jumper shunts are installed as listed below. (See figure 2 on previous page for location of jumper connectors labeled J7, J8, J9 and J10). J6 is unused.

JUMPER SHUNTS



A jumper shunt is a small plastic part used to notch connect two pins on the jumper connector. Jumper shunts should be installed notch side down.

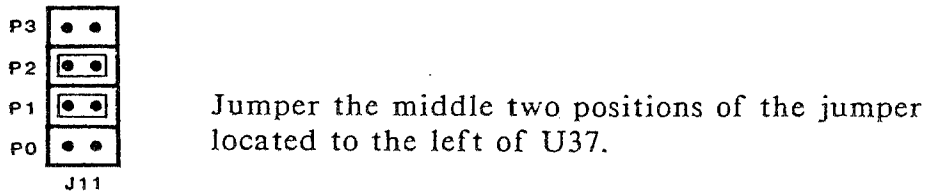
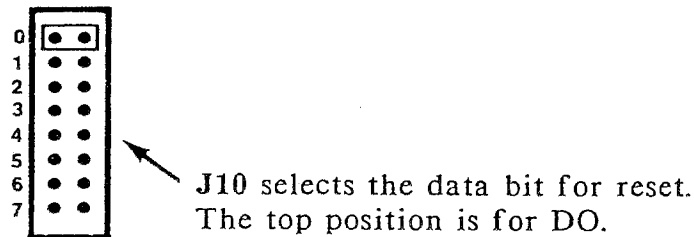
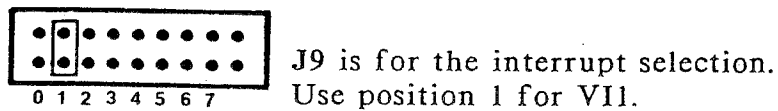
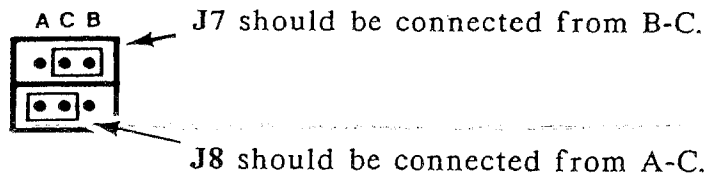

IF: The board is not correctly jumpered.

THEN: Use a pair of needle nose pliers to gently remove, and carefully replace the jumper into its proper location.

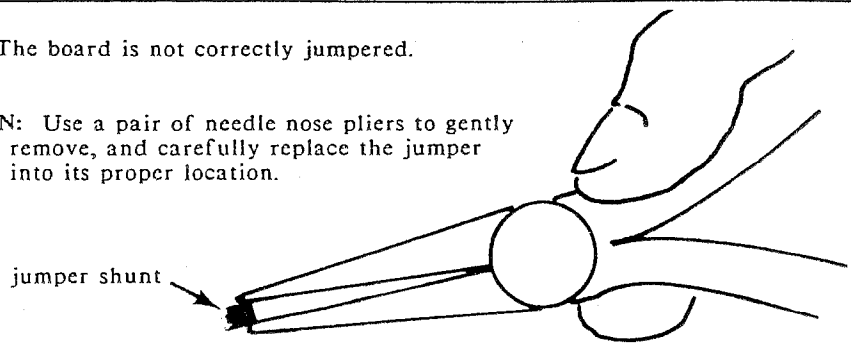

CONNECT THE CABLES FROM DISK 3 TO THE HARD DISK SUBSYSTEM

Place your hard disk subsystem near your computer enclosure. Make sure it is on a stable surface to reduce vibration when the computer is working. Make sure it is not located near telephones and magnetic fields (like those created by a generator). If you need to remove the cover from the computer, do not use a magnetic screwdriver.

CABLE INSTALLATION. Cables must be connected correctly. Be sure that when you assemble the cables the red stripe is always on the same side, and the connector plugs are inserted properly. You could connect these cables in any order. We recommend the following procedure.

WARNING: BEFORE YOU OPEN YOUR COMPUTER ENCLOSURE ALWAYS MAKE SURE THE POWER IS OFF AND IT'S UNPLUGGED. REMOVE RINGS, WATCH, ETC., WHICH CAN CONDUCT ELECTRIC CURRENT. DO NOT TOUCH THE POWER SUPPLY.

STEP 1. IDENTIFY CABLES.

- CBL14 - short 20-pin cable.
- CBL17 - long 20-pin cable.
- CBL13 - short 34-pin cable.
- CBL16 - long 34-pin cable.

STEP 2. ATTACH THE CABLES TO THE BACK PANEL OF COMPUTER ENCLOSURE.

- a) Select CBL14. Insert male connector into the "Drive 1" slot of the computer enclosure. The pins face outward and the red stripe on the cable is on the side shown on the back panel illustration below.

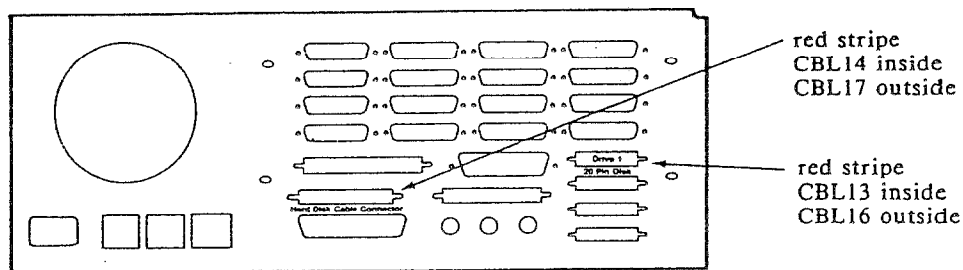
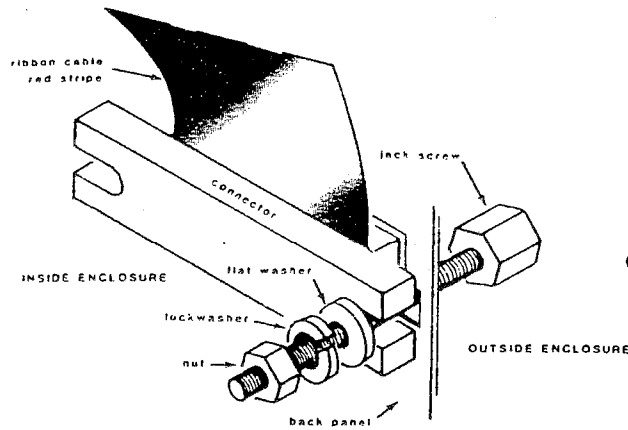

Figure 3. COMPUTER ENCLOSURE - (back panel outside)



b) Attach connector to back panel with the hardware that came with the system. (Nut/lockwasher inside and jack screw/flat washer outside the enclosure.)

c) Select CBL13. Insert the male connector into the slot inside the back panel labeled for the 34-pin hard disk cable. (See diagram on the previous page.)

d) Attach the CBL13 connector to the back panel as in step b) above.

STEP 3. INSERT THE DISK 3 INTO THE MOTHERBOARD: Place the board into the slot closest to the back of the enclosure. The edge connector is offset, so that the DISK 3 will fit only with the component side facing the front panel of the enclosure. **PUSH DOWN GENTLY UNTIL THE BOARD IS FIRMLY INSTALLED.**

STEP 4. ATTACH THE CABLES TO THE DISK 3. (Face the component side of the board.)

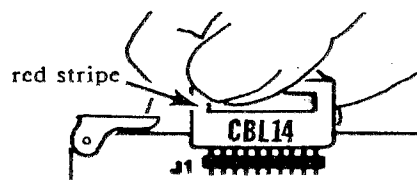

a) Pick up the female connector of CBL14. Keep the red stripe on the cable to the left.

b) Gently slide the connector onto J1. (See component legend on the board or diagram on page 2 for location of J1.)

c) Next gently slide the connector of CBL13 onto J5. (See component legend on the board or diagram on page 2 for location of J5.) Keep the red stripe on the left side on the connector.

STEP 5. ATTACH THE CABLES TO THE HARD DISK SUBSYSTEM.

- a) Take CBL17 and insert one end into the 20-pin connector you attached to the enclosure. Match the red stripes.
- b) Insert the other end of CBL17 into the back of the hard disk enclosure in the 20-pin connector (red stripe on the side away from the fan).
- c) Now take CBL16 and insert one end into the 34-pin connector you attached to the enclosure. Match the red stripes.
- d) Insert the other end of CBL16 in the 34-pin connector on the back of the hard disk, with the red stripe away from the fan.

TESTING

IMPORTANT NOTE: Make sure the 50-pin floppy disk drive cable is attached from the disk enclosure to the DISK 1 board before the CONFIDENCE TEST is run.

IT IS NECESSARY TO RUN A CONFIDENCE TEST BEFORE YOU BEGIN TO USE YOUR NEW HARD DISK SUBSYSTEM.

Follow the steps below (using the floppy-based operating diskette) to format the hard disk and run the drive confidence test. (The operating system diskette sent by CompuPro is set up to run the floppies only.)

TO BEGIN THE CONFIDENCE TEST

(This test performs a rigorous examination of the hard drive and prepares an error map which is stored on the hard disk. The bad sector relocation is done at the end of the test. It takes approximately 16 hours to complete.)

STEP 1. Turn on your system.

STEP 2. Insert a single-user (CP/M -type) operating system diskette.

STEP 3. Type: DISK3 ALL then press the return key.

STEP 4. The screen asks you if the drive to be formatted is a Quantum 540 (Q540). If it is, and you want the testing to begin, type "Y" and press the return key. The DISK 3 program will begin formatting and the cylinder number on the screen will be quickly incrementing. (Go to STEP 6.)

STEP 5. If the hard disk you want to format is not a Quantum 540, reset the system and type "DISK3 HELP". A list of possible command line arguments will be displayed. Next to the heading "drive", several commercially available disk drives are listed in an abbreviated form. If your drive is listed, you may test it by typing "DISK3 <your drive's abbreviation> ALL" and pressing the return key. The screen will ask if the drive to be formatted is the one you just typed. Type "Y" and press the return key. The test will now proceed to format your drive and the cylinder number on the screen will be quickly incremented.

If your drive is not listed, you must obtain the drive relative parameters from your drive's manufacturer. These parameters should be in the drive's manual. Type "DISK3 ALL". Then type "N" and press the return key. A drive parameter will be displayed on the screen. Type in the value of this parameter for your drive and then press the return key. The value within the parentheses will be defaulted to if you press the return key without entering a value. Continue to enter parameters until "physical interleave factor" is displayed. The value that will optimize your disk's throughput depends on the "sector size" which you previously specified as one of the parameters.

<u>Sector Size</u>	<u>Interleave</u>
2048	2
1024	2
512	3
256	3

Enter a skew according to the above table. "Retry count" is normally set to 1. "Number of reserved tracks" is dependent on the size and error-rate of your drive and must also include tracks for dynamic relocations. After you have entered all parameters, type "Y" and press the return key. The program will begin formatting the drive and the cylinder number displayed will be incremented.

STEP 6. The test formats the drive, verifies its contents, and performs the data and seek tests. You may hear a lot of noise during the seek test, but this is normal. DO NOT STOP THE TEST! Completing this test is your best guarantee that the DISK 3 and the hard disk subsystem will work properly. After the test is complete, **DO NOT REFORMAT** the disk as this will destroy the bad sector map.

I M P O R T A N T

If you have been using any hard disk with any other controller and are now going to use our DISK 3, you will have to make some kind of backup, copying your files from your hard disk onto either floppies or a tape, then reformat the hard disk as described above and copy the files back onto your hard disk.

TROUBLE?

It is acceptable to have some hard errors, but you should have no more than a total of 40. Cylinder 0 should have no errors; no head should have more than 10 errors; no head should have more than 4 tracks with multiple defect errors; and there should be no more than 1 error per megabyte of unformatted storage (40 errors).

TROUBLESHOOTING

IF: You are getting errors on every cylinder during the verify, the 20 pin cable is probably reversed.

THEN: Stop the test by pushing the RESET button. Check your cable to make sure it is correctly attached. If it is not, attach it properly and start the test again (as indicated above).

IF: The test does not work at all, the 34-pin cable is probably reversed.

THEN: Check your cable and start the test again.

CONCLUSION:

Now that the hard disk drive has been formatted and error mapped, you need to refer to your operating system manual to prepare a system diskette that will recognize the hard disk. Each operating system prepares its diskettes differently, so use your instructions for each operating system you have.

DISK 3 TECHNICAL INFORMATION

INTRODUCTION

The CompuPro DISK 3 is an intelligent, high performance Winchester disk controller. It will accept up to four soft-sectored hard disks (Seagate 506 interface or equivalent), providing controller and DMA interface functions to the IEEE 696/S-100 bus. All real time disk interactions are handled by the on board processor, eliminating the need for real time code in the host system. The only real time requirement of the host is the ability to handle the DMA transfer rate.

HARDWARE INTERFACE

The DISK 3 host interface consists of a single write-only port called an "attention" port. You can choose the address of the port by changing positions 1-7 on Switch 1. The port appears as a pair of I/O addresses. CompuPro's software expects to see the Disk 3 set at I/O port 90 hex. Set Switch 1 for the standard I/O port locations of 90 and 91 hex: Turn all Switch 1 positions ON, except for positions 1 and 4, which should be OFF. (If you followed the instructions for How To Get Your DISK 3 Up and Running Without Reading the Manual, you've already done this.)

To hold the local 8085 processor in a reset state: write a FFh to the attention port. An attention signal may be sent to the DISK 3 by writing 00h to the attention port.

The DISK 3 may be directed to generate an interrupt on completion of a command. The interrupt line to be used is selected by the installation of jumper J9 positions 0-7, and INT. These correspond to Vectored Interrupt lines VI0-VI7 and the bus INT signal line. Use the VII jumper (position 1 of J9) for operation in a CompuPro multi-user system.

All other communications between the DISK 3 and host system are handled via DMA. The priority with which the board will arbitrate for the bus to perform its DMA cycles is selected by J11, positions P0 through P3. The DISK 3 is set to a priority of 9 which is selected by jumpering positions P1 and P2 only.

On the present units, the firmware is contained in a 2764 or equivalent EPROM. The board is socketed for accepting either a 2716, 2732, or 27128. Jumpers J7 and J8 must be set according to the size of EPROM used.

	<u>2716</u>	<u>2732</u>	<u>2764</u>	<u>27128</u>
J7	B-C	B-C	B-C	A-C
J8	B-C	A-C	A-C	A-C

SOFTWARE OVERVIEW

Since the DISK 3 is an intelligent controller there is a sequence which is performed upon receiving an attention pulse from the bus master. Only the first attention pulse after an initial reset causes the unique sequence below to be executed once.

- 1) The DISK 3 fetches 16 bytes from 50h.
- 2) The 3 bytes at 5D, 5E and 5F are stored by the DISK 3 as the LINK address. All other bytes are ignored.
- 3) The DISK 3 halts and waits for the next attention. No status is returned to the host because a command was not interpreted nor executed. (NOTE: This is a departure from the EPROM versions prior to D.)

All subsequent attention pulses cause the following sequence to be executed.

- 1) The DISK 3 will fetch sixteen bytes from the LINK address specified by the last three bytes of the previous IOPB.
- 2) The DISK 3 will interpret the command and perform the task or terminate in an error state if there is some problem.
- 3) The DISK 3 will write the STATUS byte in the IOPB to let the bus master know the status of the last operation.
- 4) An interrupt will be generated if it was requested. If the continue bit is set, interrupt requests are ignored.
- 5) The DISK 3 will fetch another IOPB if the continue bit in the command byte is set. Otherwise, the DISK 3 will halt and wait for the next attention pulse. When operating in a non-interrupt mode, the bus master should verify that the DISK 3 is not busy performing the previous task when a new operation is desired.

SOFTWARE INTERFACE

The DISK 3 and host system communicate with one another through a main memory resident structure called Input Output Parameter Blocks (IOPBs). When the host system wishes to have a disk operation performed by the DISK 3, it assembles the command and any required arguments into an IOPB and signals the DISK 3 by writing the attention port. The DISK 3 will copy the IOPB to its internal RAM and interpret the command. Any required data transfers will be made automatically to the address indicated in the IOPB. When it has finished the command, the DISK 3 inserts the resulting status in the IOPB and optionally generates an interrupt.

The IOPB is a sixteen byte data structure which may begin anywhere in the sixteen megabyte address space of the IEEE 696/S-100 bus. It consists of the following byte fields:

BYTE	NAME	FUNCTION
0	COMMAND	The command to be executed.
1	STATUS	Initialized by the host to zero to indicate busy. The DISK 3 will insert the resulting status when the command has been completed.
2	DRIVE	Command is executed on this logical drive.
3	ARG1	The contents of the arguments field are command dependent.
4	ARG2	
5	ARG3	
6	ARG4	
7	ARG5	
8	ARG6	
9	ARG7	
10-12	DATA	This field contains the DMA address for any required data transfers.
13-15	LINK	This field contain the starting address of the next IOPB to be interpreted.

COMMAND - This byte contains a valid command in the range of 0 to 3F hex, along with an interrupt flag in the most significant bit position and a continue flag in bit position 6. A range check will be performed on the operation code, and if an invalid operation code is detected, the command is terminated with an argument range error. The most significant bit of the command byte is a flag which is used to indicate if an interrupt is to be generated on completion of the command. If bit 6 is set, the DISK 3 will fetch another IOPB from main memory without an attention. This will continue until there is a command with bit 6 cleared. The interrupt request bit is ignored if the continue bit of the command byte is set. Each of the operation codes are described below in the OPERATION CODE section along with their required arguments.

STATUS. - The status byte provides a handshake between the host system and the DISK 3 as well as returning the resulting status of an operation. This byte is set to zero by the host before an attention signal is issued. In non-interrupt driven systems, the status byte may be polled by the host system, the zero indicating "busy" until the actual completion status is provided. A status of FF hex indicates successful completion of the command. Other possible results are operation code dependent and are listed here.

STATUS CODE*	DESCRIPTION
0	Busy - DISK 3 has not completed current command.
1	Argument range error - something is wrong in the IOPB.
2	Drive not ready.
3	Time out (header not found).
4	Data CRC error.
5	Write fault.
6	Overrun on bus.
7	Header CRC error.
8	Map full.
FF	Completed with no errors.

*These status codes may also appear as error message numbers.

DRIVE - This is the physical drive number of the drives as connected to the DISK 3 board. The first drive is drive 0 and the last drive on the DISK 3 board will be drive 3. A range check will be performed on the contents of the DRIVE byte, and if the selected drive is not within the range specified for the DISK 3 board, an argument range error is indicated and the command is terminated. Otherwise, the indicated drive is selected for the current command and the command is executed.

ARG1-ARG7 - These bytes contain command-specific information described in the OPERATION CODE section of the manual. Commands which interact with the drives (seek, read, or write) will first test DRIVE READY and may terminate with a NOT READY status.

DATA - This three byte field contains the starting address for the DISK 3 data transfer. It is used for both reading information from the disk and writing information to the disk. This address is also where header images must reside when formatting.

LINK - When the DISK 3 receives an attention, it clears any interrupt that it may be asserting and then fetches the 16 bytes from the new IOPB as pointed to by the LINK field of the previous IOPB. For many applications, the interface to the DISK 3 will use a single IOPB after leaving the original LINK address at 50 hex. If using a single IOPB, the LINK field is simply pointed to the start of the IOPB and not altered from one command to the next.

OPERATION CODES - The following operation codes are available in the EPROM. Note that the code numbers are specified in Hex.

CODE	FUNCTION	DESCRIPTION
00	NOOP	May be used to LINK to a new IOPB or to clear an interrupt.
01	VERSION	This command will return the current version of the internal firmware in the EPROM on the DISK 3 board in ARG1 as a hex number.
02	GLOBAL	ARG1-ARG7 contain global information which is true for all drives connected to the DISK 3. This information is: ARG1 - Mode of operation. If Mode is OFFH then a 32 bit field specifying an absolute sector number to be read or written will be used for the read/write command. If Mode is Zero then two 16 bit fields containing logical sector and logical track are used for the read/write command. ARG2 - Number of retries which should be performed before returning an error status to the system. ARG3 - Number of drives connected to all the DISK 3 boards in the system.
03	SPECIFY	A table of parameters for the selected drive will be loaded from the main memory address indicated by DATA. See "SPECIFY" FORMAT on the following pages for the format of this table.
04	SET-MAP	Used to read a bad sector map into the internal RAM of the DISK 3 board. Data field contains the address of the relocation map which is 256 bytes long. See the Appendix for the structure of the relocation map. The DRIVE byte must contain the number of the logical drive being mapped.

- 05 HOME Drive byte contains the drive number to be "homed" to track zero at a low step rate. When not on track zero, this command waits for SEEK COMPLETE before issuing another step pulse.
- 06 SEEK Drive byte contains the drive number which will be selected. Then the selected drive will move the R/W head to the cylinder specified by arguments 1 & 2.
- 07 READ-HEADER The hardware will attempt to read any header from the presently selected track. If an error is detected in the mark or CRC, the operation will be repeated. If a valid header is found, the four physical address bytes will be transferred to DATA. If a valid header cannot be found, the command will timeout.
- 08 R/W Used for all sector reading and writing. It is a block transfer command capable of transferring from 1 to 64K sectors. The Drive byte contains the drive number. Argument 1 contains a read/write flag where 1 indicates a disk read, 0 indicates a disk write. Arguments 2-5 contain either a 32-bit absolute sector number or two 16-bit fields, the first of which is a sector number whose value ranges from zero to the number of sectors per track minus one. The second 16-bit field is the logical track number, which is the cylinder number times the number of heads per cylinder plus the head number. Arguments 2-5 are dependent on the Mode byte as explained above in the GLOBAL command. Both cylinders and heads are numbered from zero. Arguments 6 & 7 contain the number of sectors to be transferred, which must be at least 1. If the command completes without error, the track and sector arguments will be left pointing to the last sector transferred, the count will be zero and the DATA address will point to the first byte of the last sector transferred. If a hard error occurs, the arguments in the IOPB will be left so that the command may be retried by simply clearing the status and sending an attention. The track and sector will point to the sector in which the error occurred. The count will indicate the number of sectors yet to be transferred and the DATA address will indicate the next byte to be used.

09	RELOCATE	Used for relocating bad sectors found during use of the drive. This command is normally used during block R/W commands. If a hard error occurs during R/W, the STATUS byte is cleared, the command byte is replaced with RELOCATE, and attention is generated. The track entry is placed into the internal relocation map and the drive copy of the map is updated. Any data buffers that should have been written to the bad track are written to the new track, and any data already on the bad track is moved to the new track. Then the original contents of the data buffer are restored. After RELOCATE, the status byte and command bytes can be replaced with the R/W command and execution continued by issuing an attention if further transfers are to be performed.
0A	FORMAT	This command will format one track. Before it can be issued, the heads must be placed on the appropriate cylinder using the SEEK command. Argument 1 must contain the length of the intersector gap (GAP 3) divided by 4 and argument 2 must contain the fill character (normally E5) to be used in the data field. ARG3 must contain the head number to format. <ul style="list-style-type: none"> a) Specify command must precede a format b) Data field must contain address of header image in main memory which must contain four bytes per sector (cylinder, cylinder, head, sector) and account for skew.
0B	FORMAT-BAD	This command will mark the track given in Arguments 2-5 as BAD. Usually used in a format program. If Mode is 0, then Arguments 4 and 5 represent the track. If Mode is 1, the Arguments 2-5 are converted to track and sector values. The appropriate track is overwritten completely with 4Es. The drive's map should be updated with the logical track number.
0C	STATUS	The physical drive status port on the DISK 3 is read and is written in ARG1 of the IOPB.
0D	SELECT	The contents of ARG1 are transferred to the DISK 3 physical drive control ports.

- OE EXAMINE The local memory of the DISK 3 addressed by Arguments 2 & 3 will be dumped to external RAM as addressed by DATA for a count as indicated in Arguments 4 & 5.
- OF MODIFY A block of data will be transferred from main memory starting at the address indicated by DATA to the memory address within the DISK 3 indicated by arguments 2 & 3 for a count as indicated by arguments 4 & 5.

All two byte arguments are stored low byte first.

INITIALIZATION - To initialize the DISK 3, perform a software reset by pulsing the appropriate reset bit in the attention port. An initial IOPB must be constructed at 50h where all but the LINK field bytes are in a "don't care" (XX) state. The first attention signal after a reset causes the initial IOPB to be fetched from 50h but not executed. The initial IOPB's LINK field must point to the first actual IOPB to be executed. A second attention signal causes the first actual IOPB to be fetched and executed. This double attention procedure is only necessary for the first command after a reset. All subsequent attention signals will fetch the IOPB pointed to by the previous LINK field and execute immediately. Following a reset, a NOOP is usually executed to ascertain the presence of the controller board. Next, the HOME command must position the head assembly over cylinder 0 before the drive can be accessed.

If the drive has not been previously formatted, set up a block of the current drive relative parameters with zero reserved tracks in memory and issue a SPECIFY command to continue the initialization. At this point, the DISK 3 contains a null bad track map (no bad tracks). After a GLOBAL command is completed, perform a media integrity test. This operation should determine media defects and map them in memory on the basis of the logical track where the error occurred. Only one entry should be present in the map for a track with multiple errors. Do a FORMAT-BAD to mapped tracks. Addend the bad track map with two bytes of zero per entry until the desired number of reserved tracks is represented. Place a -1 (FFFFh) after the last zeroes to signify the end of the map. Write the bad map to absolute sector 1. Write the "CompuPro" and date string (16 bytes total) and a new specify block that includes the number of reserved tracks to absolute sector 0.

If the drive has been previously formatted, then cylinder 0, head 0 sectors 0 and 1 are always read into memory at the same time. It is important that the bad track relocation map be read into memory BEFORE the SPECIFY command is issued since the SPECIFY will most likely reserve some of the beginning tracks, thus making the relocation map in absolute sector 1 inaccessible. Sector 0 begins with the string "CompuPro" which can be used to insure that the drive has been formatted with a CompuPro DISK 3 format program. The specify block for this drive begins 16 bytes into sector 0 and should be sent to the controller with the SPECIFY command. The first 256 bytes of Sector 1 contain the bad track relocation map for this drive. Send the relocation map to the controller with the SET-MAP command. Sectors 0 and 1 are readable after a HOME command because the DISK 3 firmware defaults to ST506 parameters and absolute sector mode after a reset. Issue the GLOBAL command to complete the initialization.

"SPECIFY" FORMAT

The SPECIFY command is used to load drive relative parameters when the DISK 3 is initialized. The format for the table loaded by this command is described below. Each entry corresponds to two bytes stored low byte first. The table is twenty-two bytes long. Note that some of the values are scaled.

BYTE	FUNCTION	DESCRIPTION
0	STEP-RATE	The step time to be used for seek. This is the time in 100 micro-second increments. Use zero for drives with 3 us buffered seek.
2	SETTLE-TIME	The head settle time to wait following seek complete before a read or write is attempted. This is the time in 100 micro-second increments. Use zero if head settle time is included in seek complete.
4	SECTOR-SIZE	The number of bytes per sector.
6	SEC/TRK	The number of sectors per track.
8	TRK/CYL	The number of tracks per cylinder, or the number of heads.
10	MAXTRK	The number of cylinders.
12	PRECOMP	Begin using the precompensated write data at this cylinder number.

14	REDUCE	Begin using the reduced write current at this cylinder number.
16	RESERVED	Very early versions of the firmware did software skewing. Skewing is now done at the time of format. Current (D revision) firmware ignores these values.
18	RES-TRACKS	The number of tracks reserved for bad sector remapping plus one track for the CompuPro string, specify block and bad sector map.
20	POSITION	This should always be set to zero. (D - revision firmware ignores these two bytes.)

APPENDIX

DISK STRUCTURE CREATED BY THE FORMATTER (This structure will vary for each drive.)

Example: QUANTUM Q540 40 MB hard disk

Cylinder	Head	Sector	Length	Description
0	0	0	8	"CompuPro."
0	0	0	8	Disk 3 revision date.
0	0	0	22	Specify block for this drive.
0	0	1	256	Sector relocation map, organized as words with the low byte first. Possible values for each word are:
				0 Marks this entry as available for dynamic sector relocation.
				-1 Marks the end of the map.
				Other value Contains the logical track of the relocated bad sector. The offset within the map entry indicates the track number of the reserved track to use.

0	1	0	First reserved track for
.	.	.	relocated sectors.
0	7	8	
1	0	0	
.	.	.	
1	7	8	
2	0	0	
.	.	.	
2	5	8	Last possible reserved track.
2	6	0	First data track. Normally the
			previous tracks are invisible
			and this one is treated as
			cylinder 0, head 0 by the
			software.

HARDWARE SECTION

LOGIC DIAGRAM

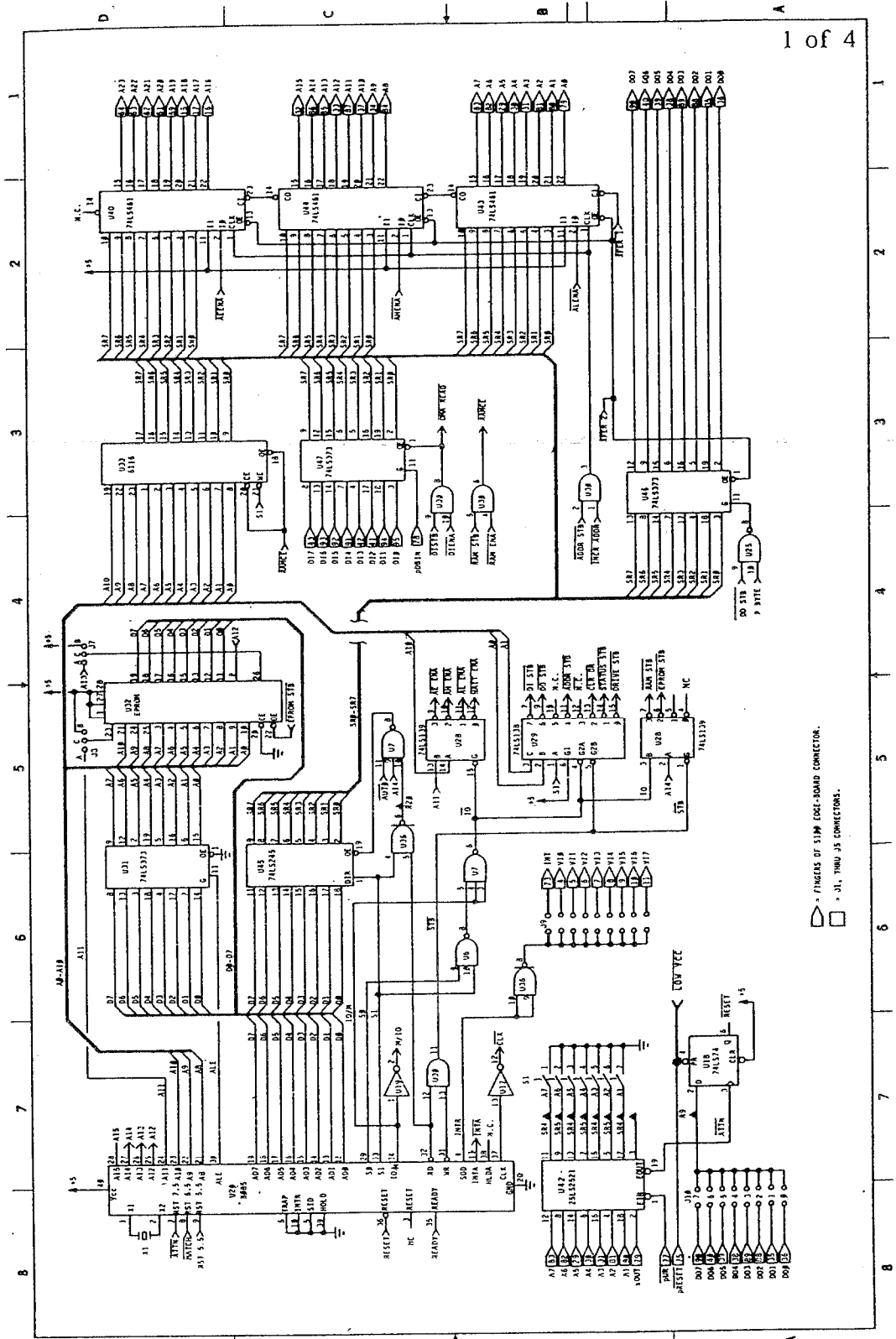

DISK 3
194G
Viasyn Corporation © 1985

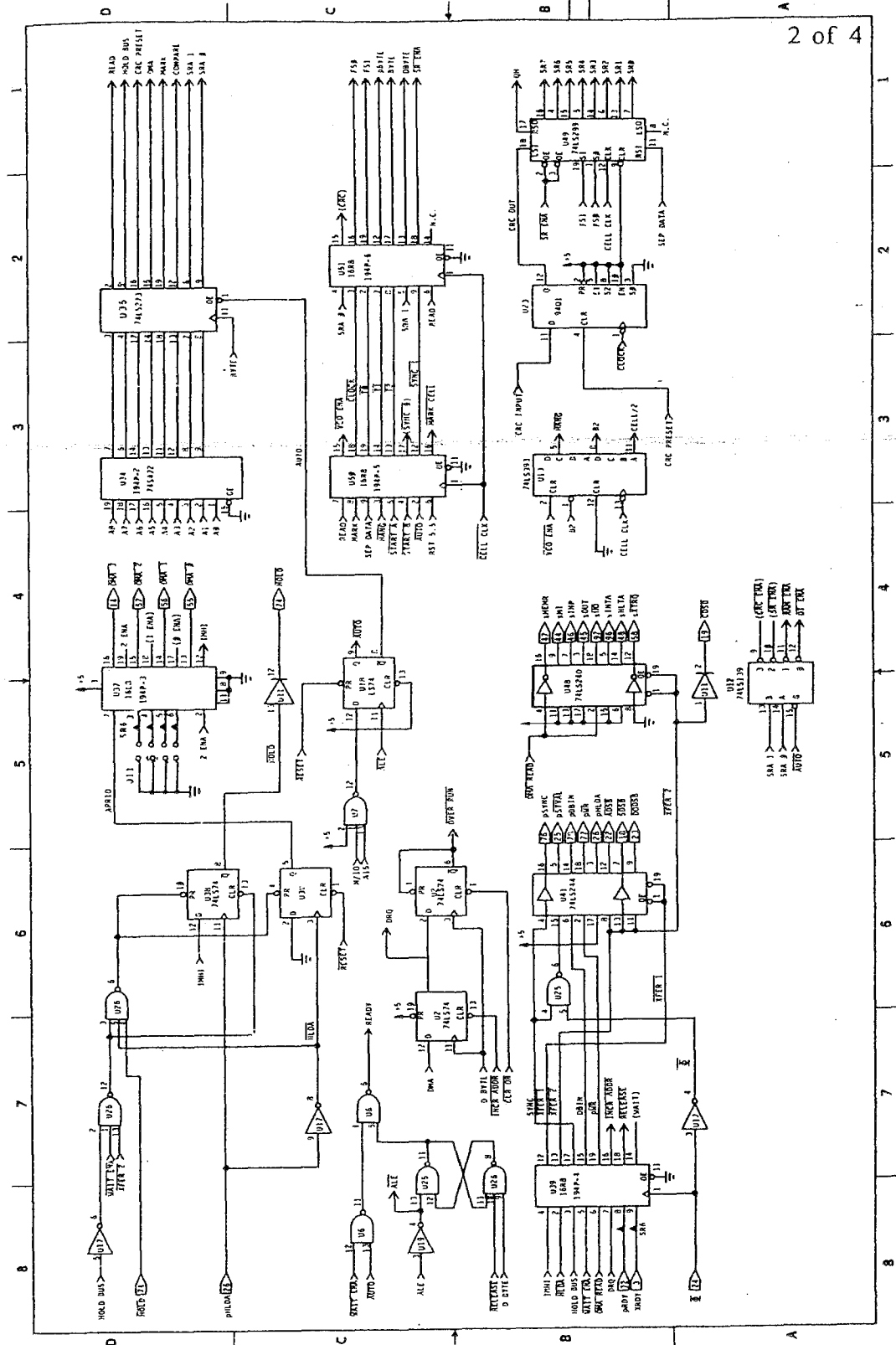

DISK 3
194G
Viasyn Corporation © 1985

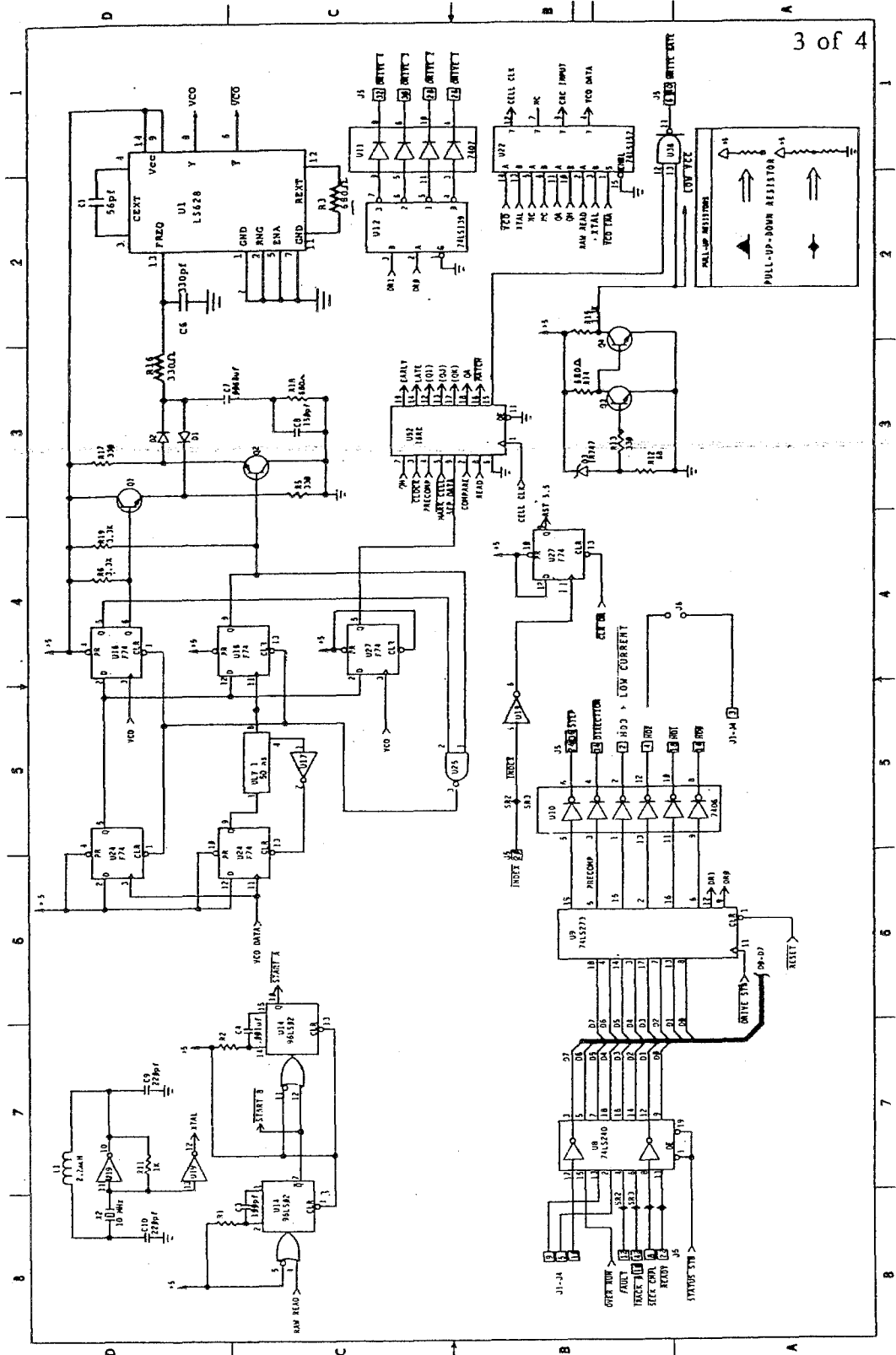

DISK 3
194G
Viasyn Corporation © 1985

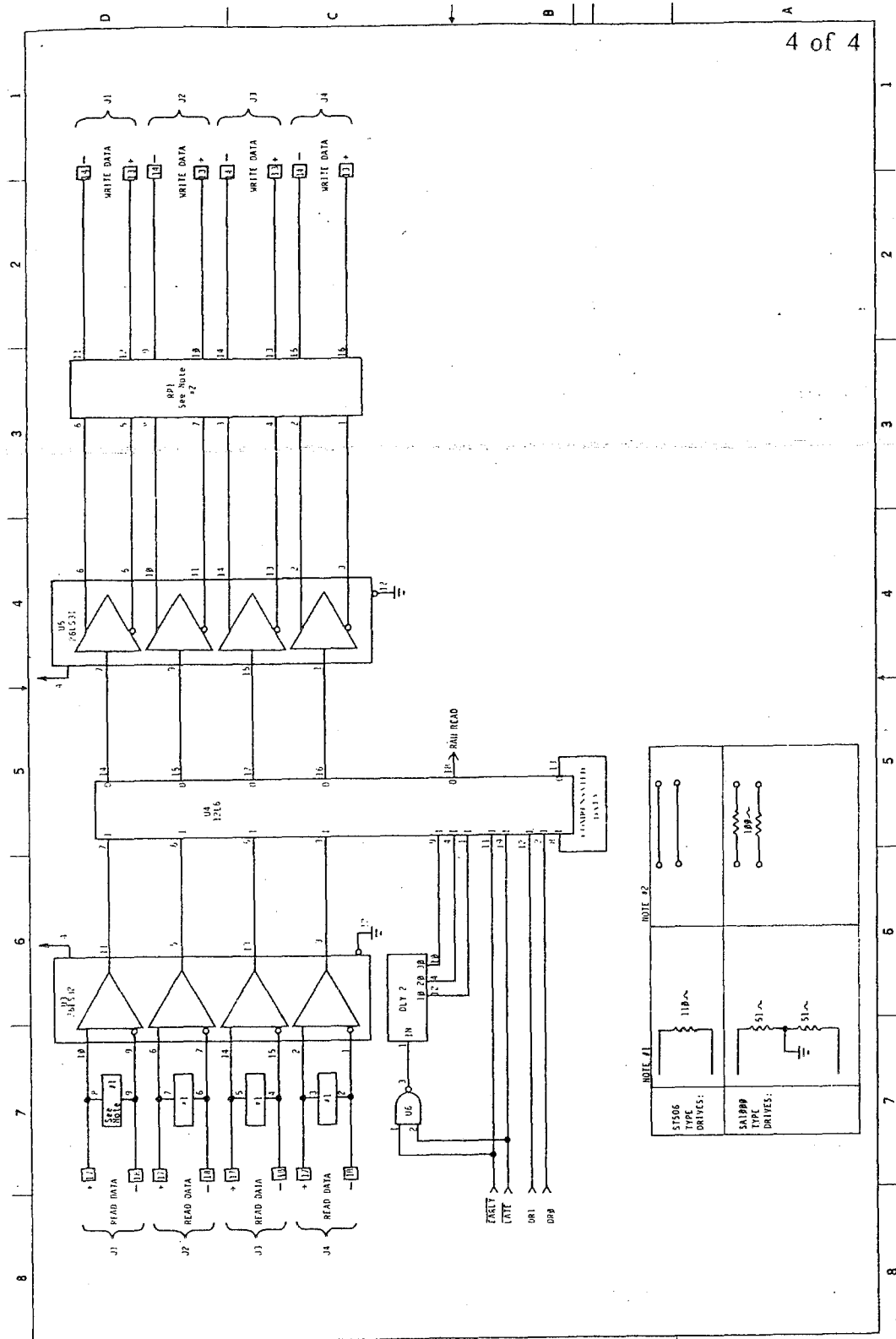

DISK 3
194G
Viasyn Corporation © 1985

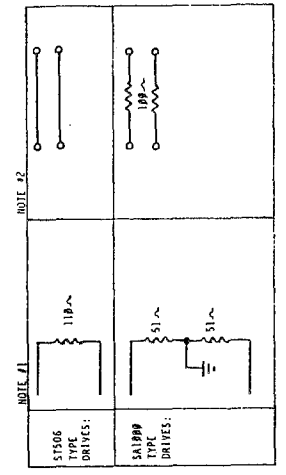

PARTS LIST

SEMICONDUCTORS

D1-D2	IN914
D3	IN747
Q1, Q3, Q4	2N3904
Q2	2N3906
U1	74LS628
U2, U18, U38	74LS74
U3	26LS32
U4	194P-1
U5	26LS31
U6	74LS00
U7, U26	74LS10
U8, U48	74LS240
U9, U35	74LS273
U10	7406 or 7416
U11	7407 or 7417
U12	74LS139
U13	74LS393
U14	96LS02
U16, U24, U27	74F74
U17	74F04
U19	74LS04
U20	8085AH-1
U22	74LS157
U23	9401
U25	74F00
U28	74LS139
U29	74LS138
U30	74LS08
U31, U46, U47	74LS373
U32	D3-PROM
U33	6116-2
U34	194P-2
U36	74LS38
U37	194P-3
U39	194P-4
U40, U43, U44	74LS461
U41	74LS244
U42	25LS2521
U45	74LS245
U49	74LS299
U50	194P-5
U51	194P-6
U52	194P-7A
U53-U55	7805 regulators
DLY1, DLY2	21198 (Potter Number)

CAPACITORS

C1	56pF (2%)
C3	100pF
C4	.001uF
C6	330pF
C7	.0068uF
C8	150pF
C9, C10	220pF
C11-C16	1.5uF
UNMARKED	.01uF

RESISTORS

R1, R20	4.7 K
R2	10 K
R3, R6, R14, R18	680 Ohms
R15, R19	3.3 K
R5, R13	
R16, R17	330 Ohms
R9	1.5 K
R11	1 K
R12	68 Ohms

SIP RESISTORS

SR1	110 Ohms
SR2	220
SR3	330
SR4, SR5	5.1 K
SR6	1.5 K

RP1 16 Pin Socket only
with Dip Shunt

MISCELLANEOUS

X1, X2	10 MHz Crystal
L1	2.2 uH Inductor
S1	8 position dip switch

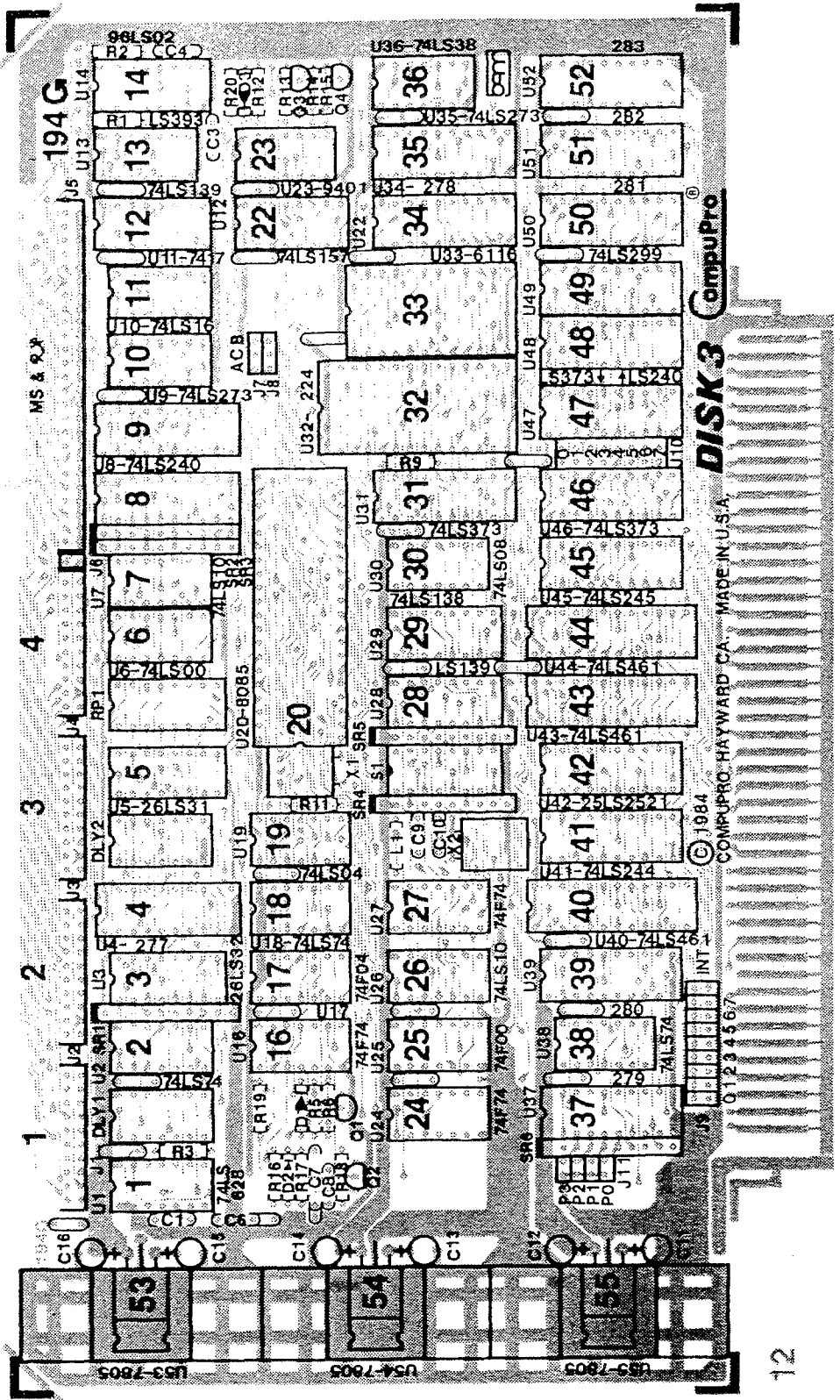

COMPONENT LAYOUT

LIMITED WARRANTY

Viasyn Corporation warrants this computer product to be in good working order for a period of one (1) year, (two (2) years for CSC boards and six (6) months for drives) from the date of purchase by the original end user. Should this product fail to be in good working order at any time during this warranty period, VIASYN will, at its option, repair or replace the product at no additional charge except as set forth below. Repair parts and replacement products will be furnished on an exchange basis and will be either reconditioned or new. All replaced parts and products become the property of VIASYN. This limited warranty does not include service to repair damage to the product resulting from accident, disaster, misuse, abuse, or unauthorized modification of the product.

If you need assistance, or suspect an equipment failure, always contact your System Center or dealer first. System Center technicians are factory trained to provide prompt diagnosis and repair of equipment failures. If you are not satisfied by the actions taken by your System Center/dealer, please call VIASYN at (415) 786-0909 to obtain a Return Material Authorization (RMA) number, or, write to VIASYN at 3481 Arden Road, Hayward, California 94545, Att.: RMA. Be sure to include a copy of the original bill of sale to establish purchase date. If the product is delivered by mail or common carrier, you agree to insure the product or assume the risk of loss or damage in transit, to prepay shipping charges to the warranty service location and to use the original shipping container or equivalent. Contact your System Center/dealer or write to VIASYN at the above address for further information.

ALL EXPRESSED AND IMPLIED WARRANTIES FOR THIS PRODUCT, INCLUDING THE WARRANTIES OF MERCHANTABILITY AND FITNESS FOR A PARTICULAR PURPOSE, ARE LIMITED IN DURATION TO THE ABOVE LISTED PERIODS FROM THE DATE OF PURCHASE, AND NO WARRANTIES, WHETHER EXPRESSED OR IMPLIED, WILL APPLY AFTER THIS PERIOD.

IF THIS PRODUCT IS NOT IN GOOD WORKING ORDER AS WARRANTED ABOVE, YOUR SOLE REMEDY SHALL BE REPAIR OR REPLACEMENT AS PROVIDED ABOVE. IN NO EVENT WILL VIASYN BE LIABLE TO YOU FOR ANY DAMAGES, INCLUDING ANY LOST PROFITS, LOST SAVINGS OR OTHER INCIDENTAL OR CONSEQUENTIAL DAMAGES ARISING OUT OF THE USE OF OR INABILITY TO USE SUCH PRODUCT, EVEN IF VIASYN OR A SYSTEM CENTER/DEALER HAS BEEN ADVISED OF THE POSSIBILITY OF SUCH DAMAGES, OR FOR ANY CLAIM BY ANY OTHER PARTY.

IF THIS PRODUCT IS OUT OF WARRANTY, PLEASE CALL THE VIASYN RMA DEPARTMENT TO OBTAIN THE FLAT RATE LABOR QUOTATION FOR FACTORY SERVICE.

**Viasyn Corporation
3481 Arden Road
Hayward, CA 94545
(415) 786-0909**

Note: This warranty supersedes all previous warranties, and all other warranties are now obsolete.



3506 Breakwater Court, Hayward, CA 94545 (415) 786-0909