

# The Slow-Stepping Debugger

Anyone doing machine level programming or hardware development can appreciate the convenience of a single-step switch. Single-stepping through a program while watching the address and data lights is a significant aid in locating where the program or hardware dies. However, nothing can be more monotonous than repeatedly pushing the single-step switch while executing an endless loop program.

Ever since the announcement that the new Altair 8800B had, in addition to the single-step function, a slow-step function, I have been envious of that and regretted that my Imsai 8080 did not have such a feature.

Slow-stepping will allow you to rapidly single-step (or slowly run if you prefer) through a program by simply holding a button depressed, thus saving much wear and tear on single-step switches, fingers and patience.

## The Original Schematic

Upon examination of the front panel schematic for the Imsai, I discovered that all of the components for this function were present and that with minor modification I could implement both single and slow step.

Fig. 1 shows a portion of the front panel schematic as it appears in the Imsai user manual. Lifting or depressing the single-step switch while in

the not run mode causes U17 (74123), a one-shot, to fire for approximately 1.5 ms. The high-to-low transition of the  $\bar{Q}$  signal from Pin 4 sets flip-flop U19 and in essence, allows the processor to run. However, during the next machine cycle, the PSYNC signal will reset U19, causing the processor to suspend operation — thus completing one step. The primary purpose of the one-shot (U17) is to clean up the switch contact closure and provide a clean clock signal to U19.

## The Modification

By rewiring the circuit and changing the value of C2 from .1uF to 10 uF (as shown in Fig. 2) U17's pulse width is now approximately 150 ms. When the single-step switch is depressed, a normal single-step cycle is generated. However, by lifting the switch, the Q output (Pin 13) is now returned to the input (Pin 1), causing the circuit to operate as a bistable multivibrator with a repetition rate of approximately 6 Hz.

Generally, it is not a good engineering practice to cause a race condition by tying the one-shot output directly to the input. However, the 74123 has sufficient propagation delay to allow this to work reliably. One word of

caution — the output pulse width for retriggering is extremely narrow and may be hard to see on all but a laboratory quality oscilloscope. I have modified several front panels and have tried many different 74123s and have yet to find any unreliable.

The modification is most easily made if you have not already assembled your front panel. If you have, the single-step switch must be desoldered and removed to facilitate the cutting of traces on the component side of the board. Cut all three traces going to the switch solder pads on the component side of the front panel board as shown in Fig. 3.

On the trace side of the CPA cut all traces going to the solder pads of S2, the single-step switch, and add the wiring shown in Fig. 4. Capacitor C2 is located near the top right hand corner of the CPA board and must be changed from a .1uF disk capacitor to a 10uF tantalum capacitor. Observe that the positive lead of the capacitor must go up to the junction of R3 and U17 (Pin 15).

The total modification should take no more than 30 minutes to perform and cost no more than the price of a good 10uF capacitor. ■

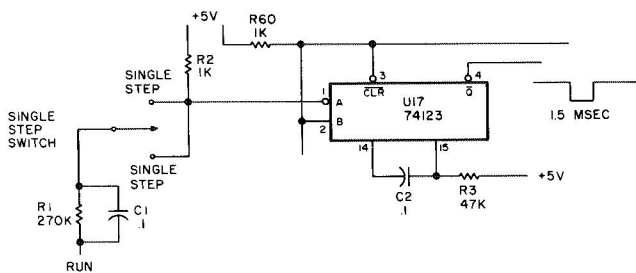

Fig. 1. Original single-step circuit.

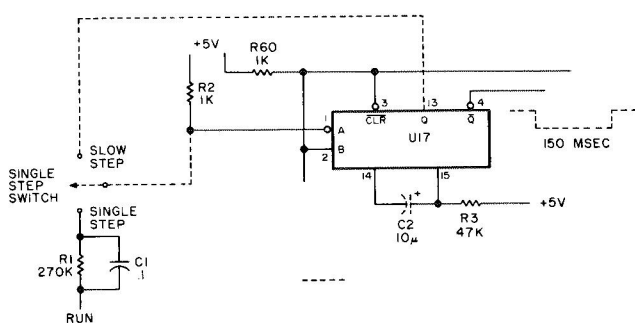

Fig. 2. Modified single-slow-step circuit.

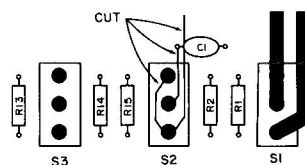

Fig. 3. CPA front side.

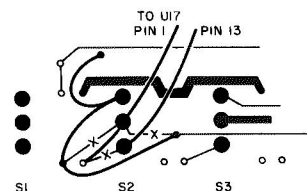

Fig. 4. CPA trace side.

# The Slow-Stepping Debugger

Anyone doing machine level programming or hardware development can appreciate the convenience of a single-step switch. Single-stepping through a program while watching the address and data lights is a significant aid in locating where the program or hardware dies. However, nothing can be more monotonous than repeatedly pushing the single-step switch while executing an endless loop program.

Ever since the announcement that the new Altair 8800B had, in addition to the single-step function, a slow-step function, I have been envious of that and regretted that my Imsai 8080 did not have such a feature.

Slow-stepping will allow you to rapidly single-step (or slowly run if you prefer) through a program by simply holding a button depressed, thus saving much wear and tear on single-step switches, fingers and patience.

## The Original Schematic

Upon examination of the front panel schematic for the Imsai, I discovered that all of the components for this function were present and that with minor modification I could implement both single and slow step.

Fig. 1 shows a portion of the front panel schematic as it appears in the Imsai user manual. Lifting or depressing the single-step switch while in

the not run mode causes U17 (74123), a one-shot, to fire for approximately 1.5 ms. The high-to-low transition of the Q signal from Pin 4 sets flip-flop U19 and in essence, allows the processor to run. However, during the next machine cycle, the PSYNC signal will reset U19, causing the processor to suspend operation — thus completing one step. The primary purpose of the one-shot (U17) is to clean up the switch contact closure and provide a clean clock signal to U19.

## The Modification

By rewiring the circuit and changing the value of C2 from .1uF to 10 uF (as shown in Fig. 2) U17's pulse width is now approximately 150 ms. When the single-step switch is depressed, a normal single-step cycle is generated. However, by lifting the switch, the Q output (Pin 13) is now returned to the input (Pin 1), causing the circuit to operate as a bistable multivibrator with a repetition rate of approximately 6 Hz.

Generally, it is not a good engineering practice to cause a race condition by tying the one-shot output directly to the input. However, the 74123 has sufficient propagation delay to allow this to work reliably. One word of

caution — the output pulse width for retriggering is extremely narrow and may be hard to see on all but a laboratory quality oscilloscope. I have modified several front panels and have tried many different 74123s and have yet to find any unreliable.

The modification is most easily made if you have not already assembled your front panel. If you have, the single-step switch must be desoldered and removed to facilitate the cutting of traces on the component side of the board. Cut all three traces going to the switch solder pads on the component side of the front panel board as shown in Fig. 3.

On the trace side of the CPA cut all traces going to the solder pads of S2, the single-step switch, and add the wiring shown in Fig. 4. Capacitor C2 is located near the top right hand corner of the CPA board and must be changed from a .1uF disk capacitor to a 10uF tantalum capacitor. Observe that the positive lead of the capacitor must go up to the junction of R3 and U17 (Pin 15).

The total modification should take no more than 30 minutes to perform and cost no more than the price of a good 10uF capacitor. ■

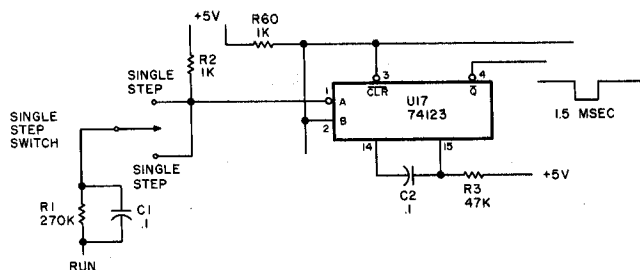

Fig. 1. Original single-step circuit.

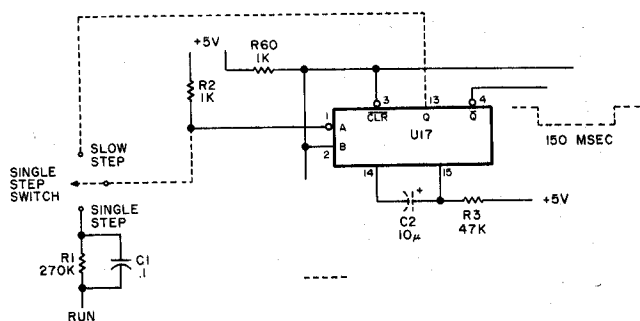

Fig. 2. Modified single-slow-step circuit.

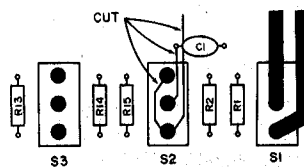

Fig. 3. CPA front side.

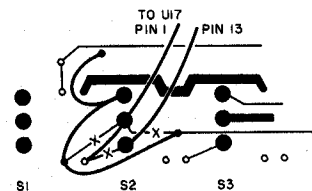

Fig. 4. CPA trace side.