

25167-1

25168-01

Ser. No. RV 344167  
MADE IN HONG KONG

5M1 T  
HD74LS244P

5M3 T  
HD74LS273P

5M1 T  
HD74LS244P

2K4 B  
HD74LS08P

2K4 B  
HD74LS08P

5M1  
HD74LS244P

4F2 B  
HD74LS54P

5M1 T  
HD74LS244P

7ALS04PC

2K4 B  
HD74LS08P

5L4 1  
HD74LS00P

5M1  
HD74LS244P

5M1  
HD74LS244P

5M1  
HD74LS244P

5L4 1  
HD74LS157P

7ALS04PC

5K1 1  
HD74LS32P

4A1 B  
HD74LS30P

5K3 1  
HD74LS138P

5M1 T  
HD74LS244P

5M1  
HD74LS244P

5M1  
HD74LS244P

5M1  
HD74LS244P

4G3 B  
HD74LS74AP

7ALS04PC

PAL 16L2ACK  
8561

5M1 T  
HD74LS244P

5M1 T  
HD74LS244P

5K3 T  
HD74LS245WP

U2

U8

U13

U19

U20

U21

U22

U23

U24

U25

U26

C2

U4

U15

U21

U22

U23

U24

U25

U26

U27

U28

U6

U10

U16

U22

U25

U26

U27

U28

U29

U30

U31

U2

U8

U13

U19

U20

U21

U22

U23

U24

U25

U26

U2

U8

U13

U19

U20

U21

U22

U23

U24

U25

U26

VIDEO IN

SANTIS  
REV-2

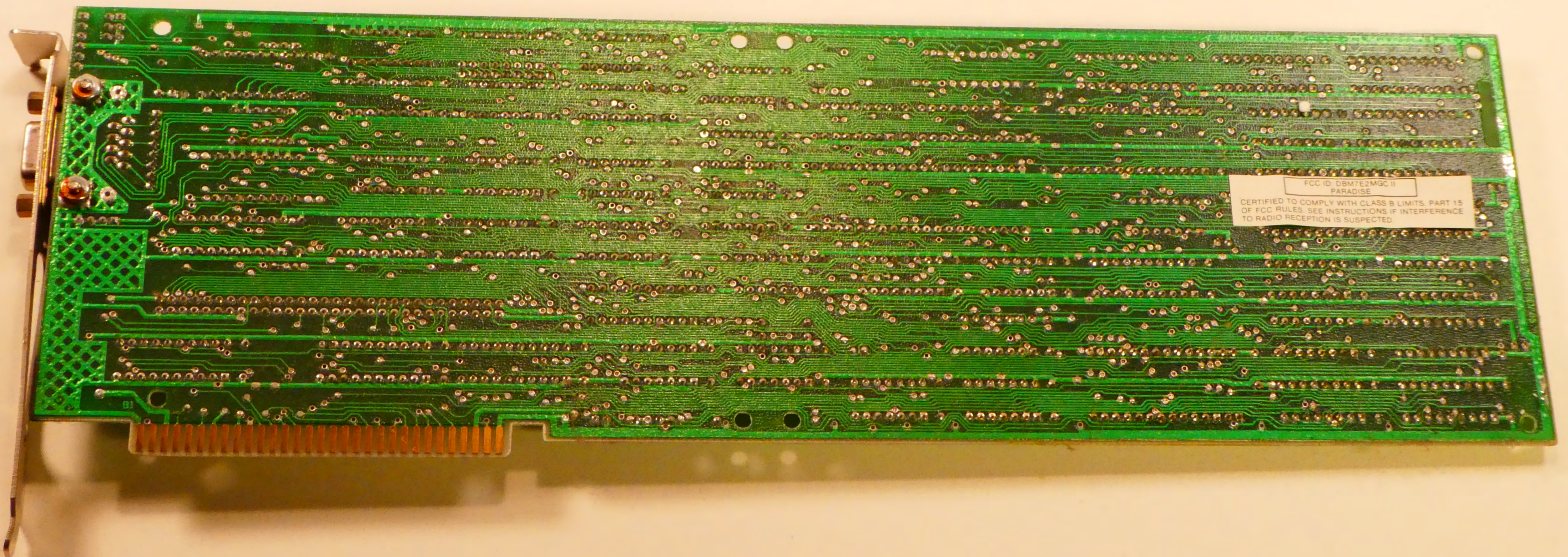

FCC ID: DBMT2MGC II  
PARADISE  
CERTIFIED TO COMPLY WITH CLASS B LIMITS, PART 15  
OF FCC RULES. SEE INSTRUCTIONS IF INTERFERENCE  
TO RADIO RECEPTION IS SUSPECTED.

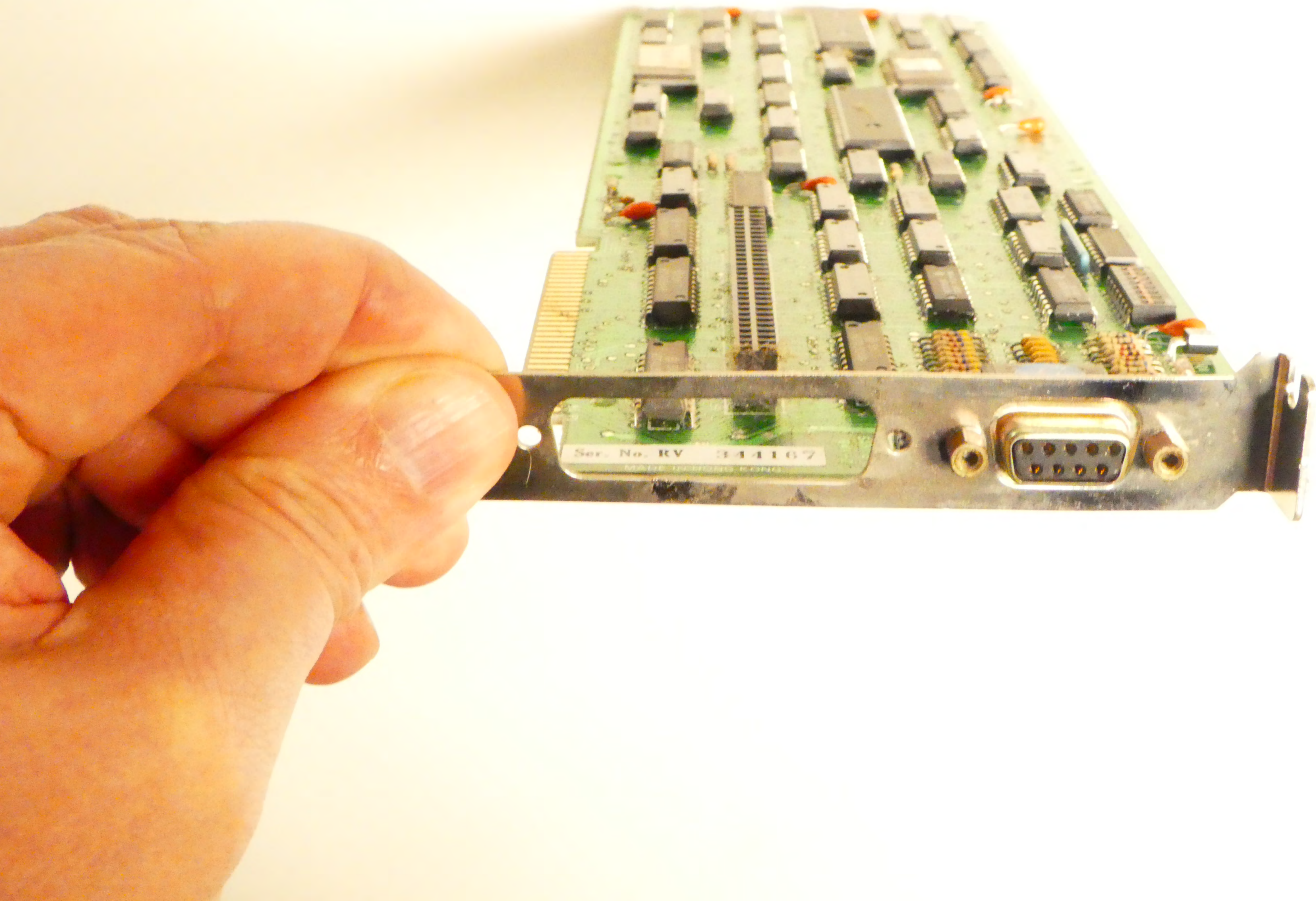

Ser. No. RV 344107

# QUICK START

## Paradise Systems Modular Graphics Card Quick Setup Sheet (For use with software releases 4.0 and later)

This document is designed to aid the experienced user in the installation and set up of the Modular Graphics Card.

These abbreviated instructions make several assumptions:

You are not attempting to install the Modular Graphics Card with any other video card present in the system and no Paradise "A" or "B" modules are present. If this describes your installation, please proceed. If not or if you have any trouble with these instructions, please refer to the main manual for step by step instructions.

If you are installing this product in an IBM "compatible", the switch settings outlined below may not be correct for your system. If you are installing the Modular Graphics Card in an IBM AT, remember that the AT has no set up switches instead, you will be using the setup program provided on your Diagnostic diskette.

**WARNING:** Do not use this quick setup guide if an IBM monochrome or equivalent display adapter also resides in your system. Make sure that you understand each step. Improper setting of the monitor select jumper can damage your monitor.

1. Open your system and locate Switch 1 on your system's main board.
2. Do you have an 8087 co-processor installed? Set levers as shown.

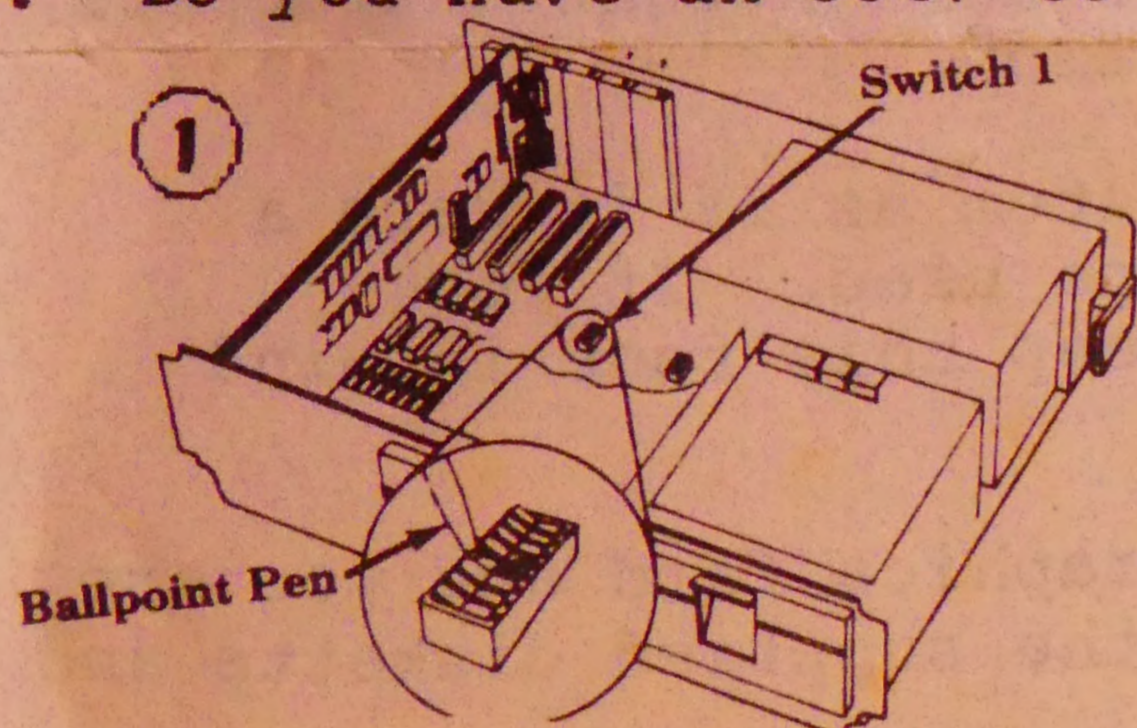

2

Do you have an 8087 CO-PROCESSOR?	SET LEVERS 2, 5 & 6 AS SHOWN
<b>8087 CO-PROCESSOR NOT INSTALLED</b>	SW 1  ON 1 2 3 4 5 6 7 8
<b>8087 CO-PROCESSOR INSTALLED</b>	SW 1  ON 1 2 3 4 5 6 7 8

3. Set the Monitor Select Jumper (P2) as appropriate for your installation

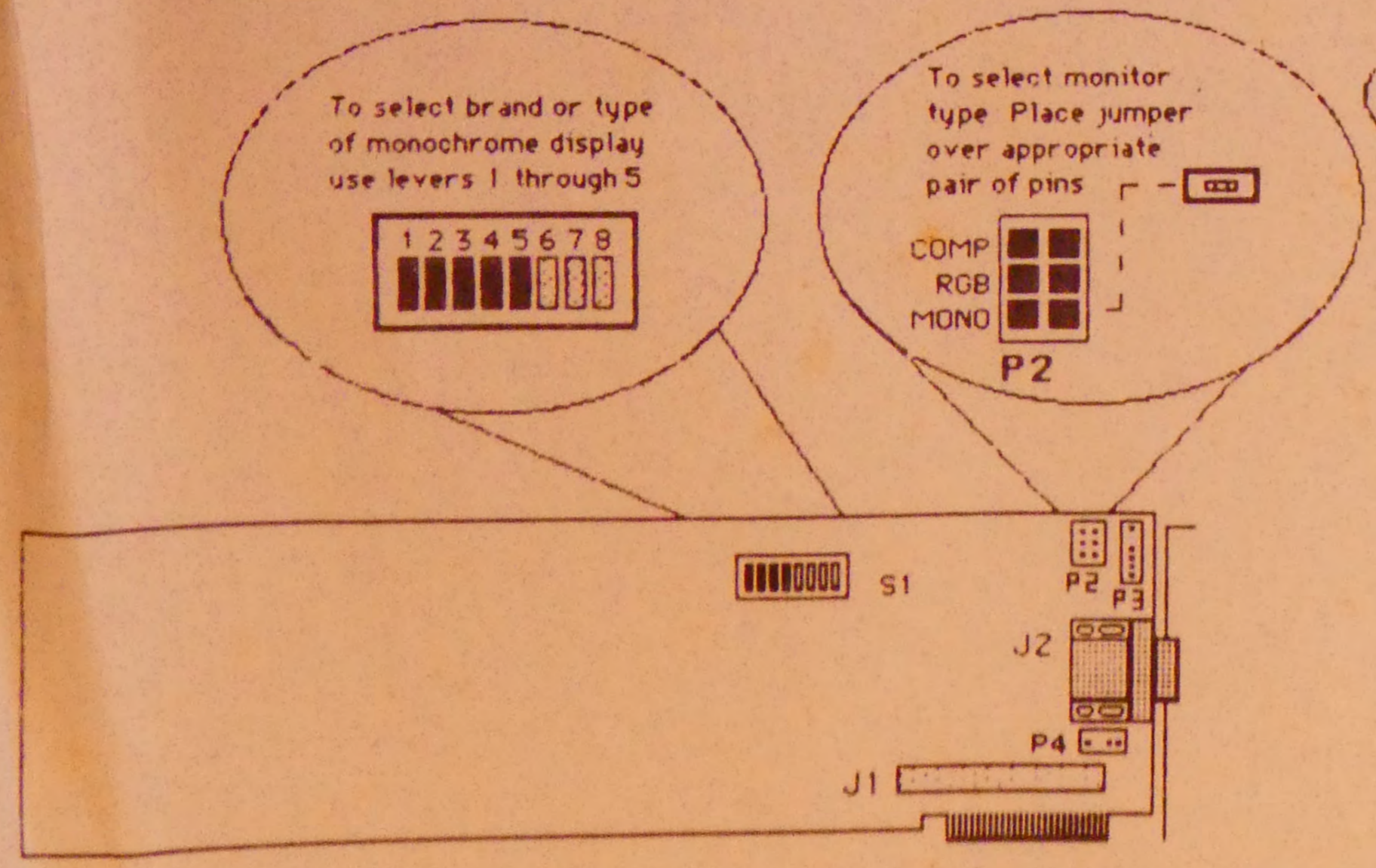

3

MONITOR TYPE	POSITION OF MONITOR SELECT JUMPER
MONOCHROME (LIKE IBM)	"MONO" (FACTORY SETTING)
RGB COLOR	"RGB"
COMPOSITE*	"COMP"

\* REQUIRES COMPOSITE ADAPTER. AVAILABLE FROM PARADISE

(over)

4. MONOCHROME DISPLAY USERS: Find the correct settings for levers 1 through 5 of S1 on the Modular Graphics Card for your monitor. Levers 6, 7 and 8 are not used at this time. If your monitor is not listed here refer to Appendix G of the main manual.

Brand of Monochrome Display	Lever 1	Lever 2	Lever 3	Lever 4	Lever 5
IBM	OFF	OFF	OFF	OFF	OFF
Princeton MAX-12	ON	OFF	ON	OFF	OFF
Roland MB-122 Series	OFF	ON	OFF	ON	OFF
Roland MB-142	OFF	OFF	ON	ON	OFF
Leading Edge	ON	OFF	OFF	ON	ON
Grandwood Monochrome	OFF	OFF	OFF	OFF	OFF
AMDEK 310A	OFF	OFF	ON	ON	OFF
ITT Monochrome	OFF	ON	ON	ON	ON

5. Insert the modular Graphics Card into any unused expansion slot. Attach monitor cables. Plug monitor and system into power source.

#### DOUBLE CHECK YOUR WORK

Your installation of the Modular Graphics Card is complete. If you are using a monochrome display and you see a rolling screen or half height characters, please refer to the main manual for further information.

The Modular Graphics Card always appears to your system as if it were a color/graphics adapter regardless of the monitor type used. If your application software has an installation program, keep this fact in mind during installation.

If you want to run IBM Diagnostics on the Modular Graphics Card and you are using a monochrome display, start your system with the supplied diskette and follow the screen prompting.

When in doubt see the main manual.

# PARADISE

---

S Y S T E M S , I N C

## Modular Graphics Card Users Manual & Installation Guide

For use with Paradise MGC Software  
Version 4.0 or Later

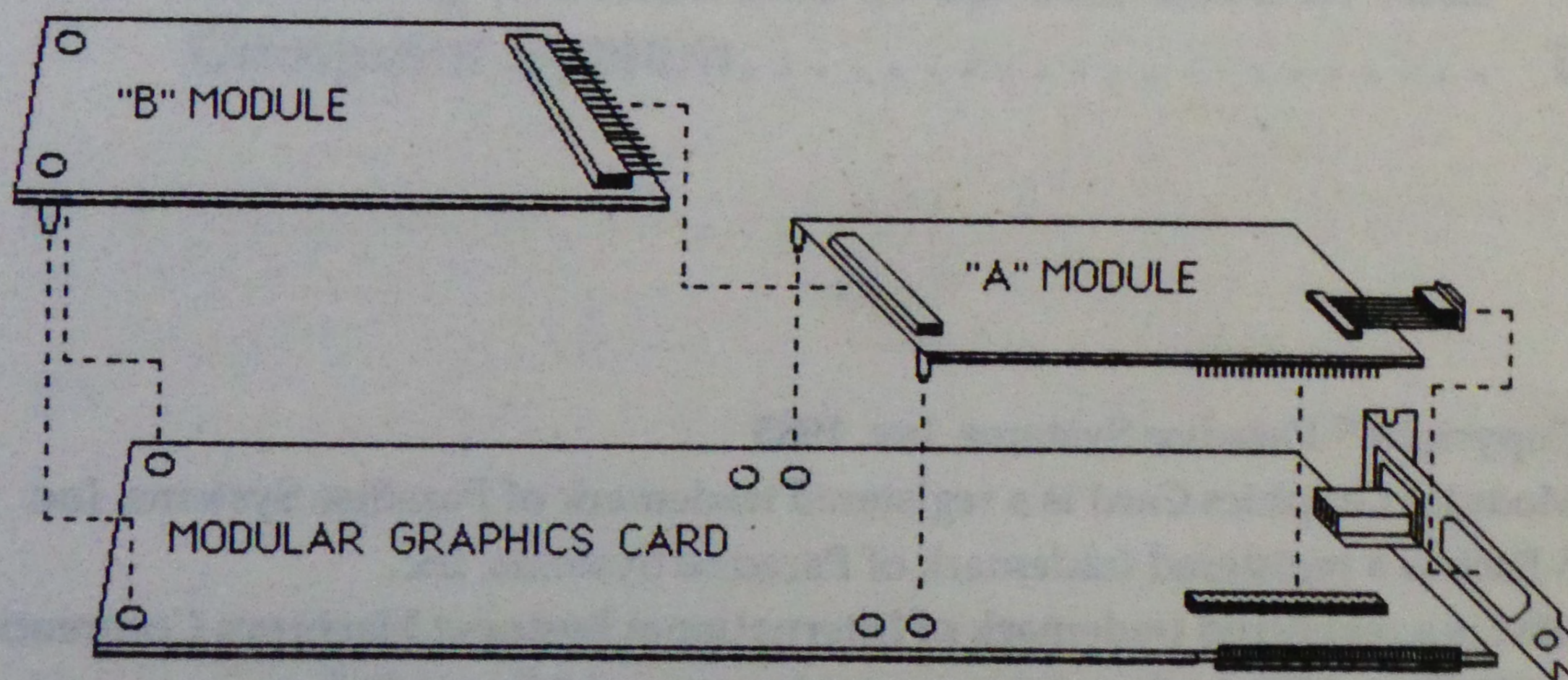

COPYRIGHT © 1985  
PARADISE SYSTEMS, INC.

**PARADISE SYSTEMS, INC.**

**Modular Graphics Card  
User's Guide and Installation Manual**  
(For use with Paradise software versions 4.0 and above)

Copyright © Paradise Systems, Inc. 1985

Modular Graphics Card is a registered trademark of Paradise Systems, Inc.

5-Pack is a registered trademark of Paradise Systems, Inc.

IBM is a registered trademark of International Business Machines Corporation

MSDOS and Flight Simulator are trademarks of Microsoft, Inc.

LOTUS and 1-2-3 are trademarks of Lotus Development Corporation

SideKick is a trademark of Borland International, Inc.

Spotlight is a trademark of Software Arts, Inc.

Modular Graphics Card Manual, Revision 1, July 1985

Paradise Systems, Inc. Part Number 25158

**Table of Contents**

**Paradise Systems Modular Graphics Card . . . . . v**

**Modular Graphics Card Manual . . . . . vi**

**1.0 Overview of the Paradise Systems Modular Graphics Card. . . . . 1**

1.1 Layout of the Modular Graphics Card . . . . . 1

1.2 Compatibility of the Modular Graphics Card . . . . . 2

1.3 Tools You Will Need to Install the Modular Graphics Card . . . . . 2

1.4 How to Set Dip Switches . . . . . 3

**2.0 Setting the Modular Graphics Card Controls . 5**

**3.0 Making Your Computer Ready for the Modular Graphics Card. . . . . 7**

3.1 Open Up Your Computer System. . . . . 7

3.2 Setting Your Computer's System Board Switches . . . . . 8

**4.0 Installing Modules on the Modular Graphics Card. . . . . 11**

4.1 Adding an "A" Module . . . . . 12

4.2 Adding a "B" Module . . . . . 13

**5.0 Installing the Modular Graphics Card in Your Computer System. . . . . 15**

**6.0 Modular Graphics Card Monochrome Video Support Software . . . . . 19**

- 6.1 An Introduction to Monochrome Operation . . . . . 19
- 6.2 Non-IBM Computers and/or Non-IBM Monitors . . . . . 20
- 6.3 Some Conventions . . . . . 20
- 6.4 Installing the Monochrome Software . . . . . 21
  - 6.4.1 Floppy Disk System Users . . . . . 21
  - 6.4.2 Hard Disk System Users . . . . . 22
- 6.5 Configuring Your Application Software . . . . . 23
- 6.6 Special Notes for Those Who Use Monochrome Software . . . . . 23
- 6.7 Troubleshooting . . . . . 24
- 6.8 Screen Rolling and How to Deal With It . . . . . 25
- 6.9 Rolling Screens With a Particular Software Package . . . . . 26
- 6.10 Some Options for RGB and Composite Users . . . . . 26

**7.0 Ramdisk Software . . . . . 29**

- 7.1 What is a Ramdisk and What Can It Do for Me . . . . . 29
- 7.2 Compatibility of Ramdisk Software . . . . . 30
- 7.3 Copying the Ramdisk Software to Your Working Diskette . . . . . 30
- 7.4 Making Your System Ready to Use Ramdisk Software . . . . . 31
- 7.5 Starting the Ramdisk Software . . . . . 34
- 7.6 Using Ramdisks . . . . . 35

**8.0 Print Spooler Software . . . . . 37**

- 8.1 What is a Print Spooler and What Can It Do for Me . . . . . 37
- 8.2 Compatibility of Print Spooler Software . . . . . 37
- 8.3 Copying the Print Spooler Software to Your Working Diskette . . . . . 38
- 8.4 Starting the Print Spooler . . . . . 39
- 8.5 Using the Print Spooler . . . . . 41

**9.0 Clock-Calendar Software . . . . . 43**

- 9.1 All About Clock-Calendar Software . . . . . 43
- 9.2 Copying the Clock Software to Your Working Diskette . . . . . 43
- 9.3 Setting the Clock-Calendar . . . . . 44
- 9.4 Setting Your Computer's System Clock From the Clock-Calendar . . . . . 45
- 9.5 Making Time and Date Setting Automatic . . . . . 45

**Appendices**

- A. Using IBM Diagnostics With the Modular Graphics Card . . . . . 47
- B. Technical Specifications of the Modular Graphics Card . . . . . 49
- C. Warranty and Service Information . . . . . 53
- D. Installation Considerations for Amdek & Quadram Mono Displays . . . . . 55
- E. Modular Graphics Card Connector Pin-Outs . . . . . 57
- F. Using the Modular Graphics Card in a Two Monitor System . . . . . 59
- G. Finding the Right S1 Settings for Your Display . . . . . 61

**List of Figures**

- Figure 1.1 Features and Controls of the Modular Graphics Card . . . . . 1
- Figure 1.2 Types of Dip Switches . . . . . 3
- Figure 2.1 Features and Controls of the Modular Graphics Card . . . . . 5
- Figure 3.1 Location of Cover Mounting Screws, Back of System . . . . . 7
- Figure 3.2 Removing the System Unit Cover . . . . . 8
- Figure 3.3 Location of Dip Switches 1 & 2 on the IBM PC . . . . . 9
- Figure 4.1 Installing A & B Modules on the Modular Graphics Card . . . . . 11
- Figure 5.1 Details of Expansion Slots . . . . . 15
- Figure 5.2 Inserting the Modular Graphics Card in Your System . . . . . 16
- Figure 5.3 Details of Video Connectors & Composite Adapter . . . . . 17
- Figure 7.1 Location of Dip Switches 1 & 2 on the IBM PC . . . . . 32

**List of Tables**

- Table 2.1 Monitor Select Jumper Settings By Monitor Type . . . . . 6
- Table 2.2 Switch S1, Levers 1 Through 4 Select Monochrome Display . . . . . 6
- Table 3.1 Setting Levers 2, 5 & 6 of Switch 1 . . . . . 9
- Table 7.1 Setting Levers 7 & 8 of Switch 1, Disk Drives Switches . . . . . 26
- Table G1 Switch S1, Levers 1 Through 5 Select Monochrome Display . . . . . 43



FCC Notice:

FCC ID: DBM7E2MGC II

**Warning:** This equipment generates and uses radio frequency and if not installed and used properly, that is, in strict accordance with manufacturers instructions, may cause interference with radio and television reception. It has been type tested and found to comply with the limits for a Class B computing device in accordance with the specifications in Subpart J of Part 15 of FCC Rules, which are designed to provide reasonable protection against such interference in a residential installation. However, there is no guarantee that interference will not occur in a particular installation. If this equipment does cause interference to radio or television reception, which can be determined by turning the equipment off and on, the user is encouraged to try to correct the interference by one or more of the following measures:

Reorient the receiving antenna.

Relocate the computer with respect to the receiver.

Move the computer away from the receiver.

Plug the computer into a different outlet so that the two devices are on different branch circuits.

If necessary, the user should consult the dealer or an experienced radio/television technician for additional suggestions. The user may find the following booklet prepared by the Federal Communications Commission helpful:

"How to Identify and Resolve Radio-TV interference problems".

This booklet is available from the U.S. Government Printing Office, Washington, DC 20402, Stock No. 004-000-00345-4

## Paradise Systems Modular Graphics Card

The Paradise Systems Modular Graphics Card is an advanced video display adapter for the IBM PC, XT, AT and compatible computers. The Modular Graphics Card provides the ability to support the IBM monochrome display, in both text and IBM color/graphics adapter compatible modes, without the use of special "pre-boot" drivers when installed in IBM and most compatible computers. The Modular Graphics Card can also function as a standard color/graphics adapter driving RGB and composite monitors.

The Modular Graphics Card provides the facilities to add other functions to the card through the use of add-on modules. See your Paradise dealer or contact us directly for details of these add-on modules.

The Modular Graphics Card can support the following monitor types:

- RGB color displays that may be driven by the IBM color/graphics adapter.
- Composite video displays that may be driven by the IBM color/graphics adapter.
- The IBM monochrome display and most third party replacements for the monochrome display.

The Modular Graphics Card comes with the following software:

- RAMDISK software.
- PRINT SPOOLER software.
- CLOCK SET AND READ software (supports the Paradise memory/clock module).
- MONOCHROME DISPLAY support software (This software is provided for use with some non-IBM computer systems.)

## The Modular Graphics Card Manual.

Welcome to the growing family of Paradise Systems users. This manual is designed to guide you smoothly and easily through the installation of your Paradise Modular Graphics Card.

The sections that follow describe in detail the set up and installation of the Modular Graphics Card. Each section includes detailed step-by-step instructions. Technical information of interest to programmers and other experienced users will be found in the Appendices of this manual.

Information that is specific to a group of users such as IBM AT USERS: is identified with bold lettering at the beginning of the applicable paragraph(s). Some of the illustrations in this manual are repeated several times. This is done intentionally to minimize page flipping as you install your Modular Graphics Card.

**BEFORE YOU START:** Take a look at the table of contents of this manual. It will give you an idea of the steps necessary to install the Modular Graphics Card. Special topics are covered in the Appendices of this manual. Read through the list and see if any of these topics apply to your installation.

You may contact us at:

Paradise Systems, Inc.  
217 East Grand Avenue  
South San Francisco, CA 94080  
(415) 588-6000

## Section 1 — Overview of the Paradise Systems Modular Graphics Card

### 1.1 Layout of the Modular Graphics Card

Figure 1.1 (below) shows the features and controls of the Modular Graphics Card. Study it and make sure that you can identify the following items. They will be referenced throughout this manual.

- S1, The Monochrome Display Selector Switches.
- P2, The Monitor Select Jumper.
- P3, The Light Pen Connector.
- P4, The RF Modulator Connector.
- J1, The Module Connector.
- J2, The Video Connector.

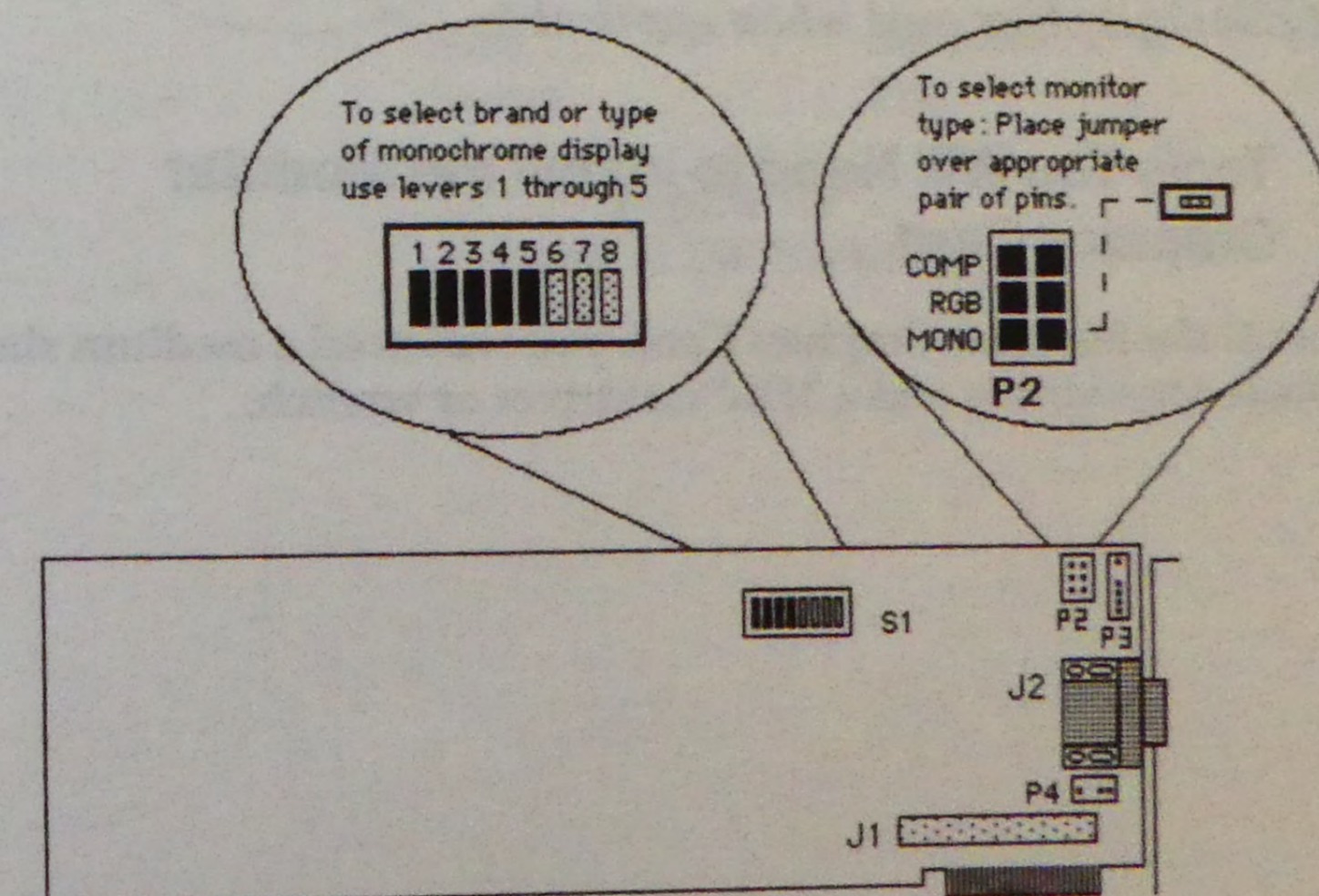

Figure 1.1  
Features and Controls of the Modular Graphics Card

## 1.2 Compatibility of the Modular Graphics Card

The Modular Graphics Card may be used with any of the following monitors: IBM (or equivalent monochrome displays), RGB displays or composite displays. Regardless of the monitor type that you use, the Modular Graphics Card always appears to your computer system as if it were an IBM color/graphics card. This means that applications requiring graphics capability will work with the Modular Graphics Card and any monitor.

**RGB & COMPOSITE MONITOR USERS:** In general, when using the Modular Graphics Card, no special software is needed for normal operation. Two special features, however, are available to you when using RGB or composite monitors. These features and their use are described in section 6.10 of this manual.

**MONOCHROME DISPLAY USERS:** When using the Modular Graphics Card with a monochrome display, in an IBM personal computer and most compatible computers, no special software is needed to use the card. *When using the Modular Graphics Card, you must configure your application packages for use with an IBM color/graphics card when applicable.*

## 1.3 Tools You Will Need to Install the Modular Graphics Card

To install the Modular Graphics Card, you will need a medium size flat blade screwdriver and a 3/16" nutdriver or wrench.

## 1.4 How to Set DIP Switches

This manual will make constant reference to switches with rows of levers called DIP Switches. These switches are found on the Modular Graphics Card as well as the system boards of the various computer systems in which the Modular Graphics Card may be installed. These switches come in two styles: slide switches and rocker switches. Refer to Figure 1.2 for a detailed view of how to set these switches. The ballpoint pen in each illustration is turning a lever to the ON position. Remember that OPEN means OFF.

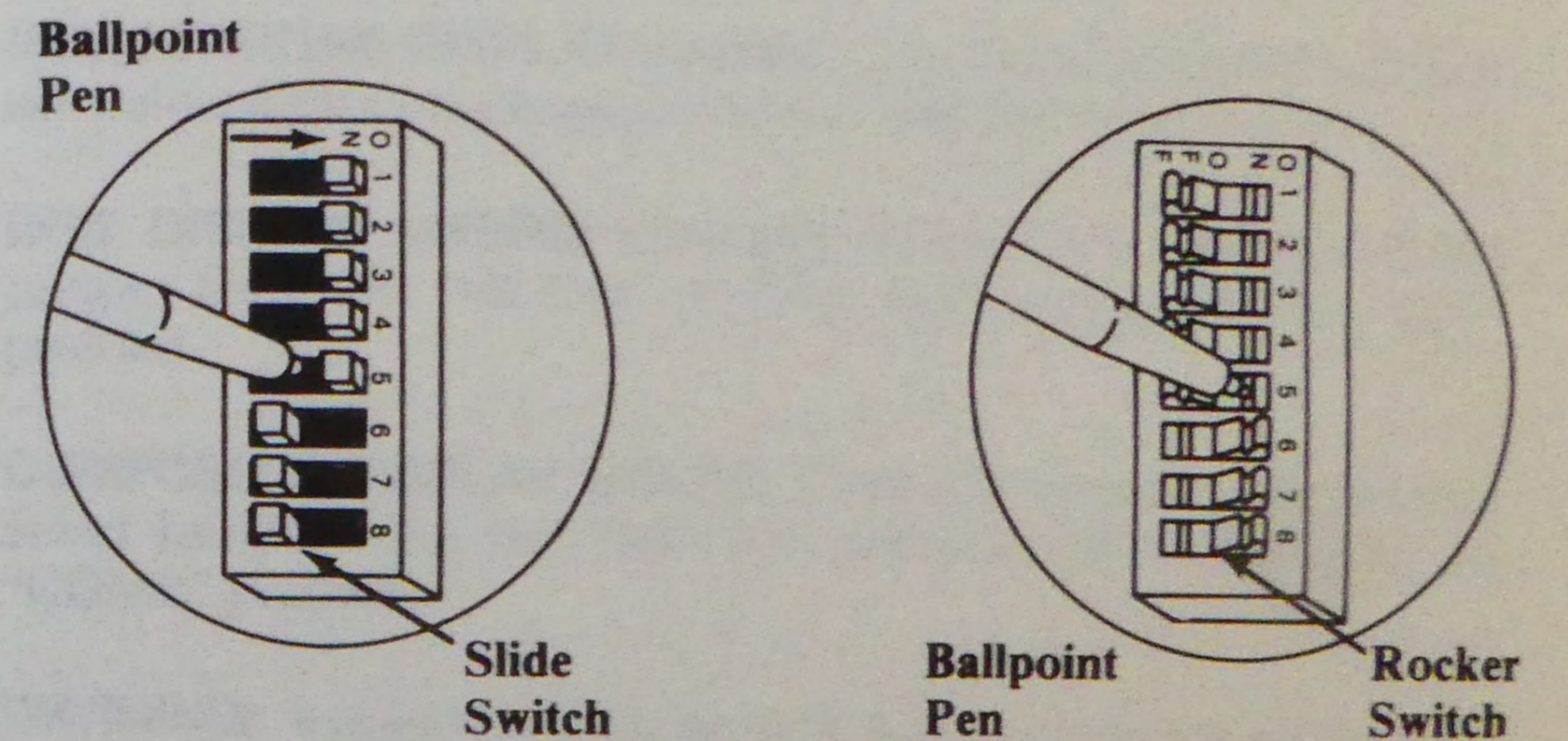

Figure 1.2  
Types of DIP Switches

## Section 2 — Setting the Modular Graphics Card Controls

Refer to Figure 2.1 (below), find P2, (the Monitor Select Jumper) on the Modular Graphics Card. The position of the Monitor Select Jumper determines what kind of monitor will be supported by the Modular Graphics Card. Table 2.1 (below) illustrates the proper settings of this control. The Monitor Select Jumper comes from the factory plugged into the "MONO" position.

**MONOCHROME DISPLAY USERS:** Check to be sure that the Monitor Select Jumper is plugged into the "MONO" position.

**RGB DISPLAY USERS:** Carefully remove the Monitor Select Jumper from the "MONO" position and change it to the "RGB" position.

**COMPOSITE DISPLAY USERS:** Carefully remove the Monitor Select Jumper from the "MONO" position and change it to the "COMP" position.

**WARNING:** It is extremely important that you properly set this control for the type of monitor that you will be using with the Modular Graphics Card. Improper settings can result in damage to your monitor.

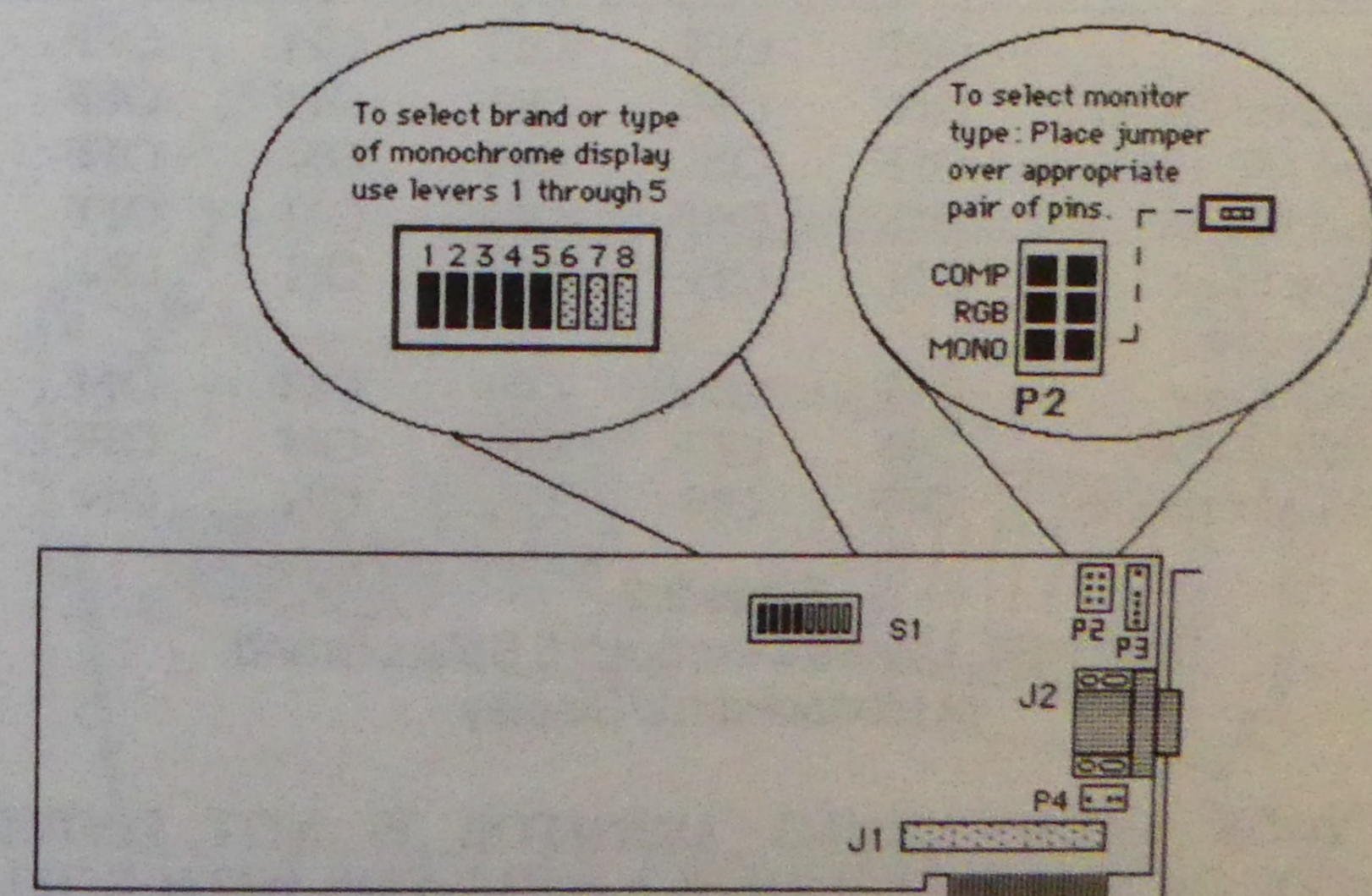

**Figure 2.1**  
Features and Controls of the Modular Graphics Card

Monitor	Position of Monitor Select Jumper
Monochrome	"Mono" (Factory Setting)
RGB Color	"RGB"
Composite*	"COMP"

\* Requires Composite Adapter, Available from Paradise

**Table 2.1**  
Monitor Select Jumper Settings by Monitor Type

Refer again to Figure 2.1. Find the eight lever switch, S1. Levers one through five are used to tell the Modular Graphics Card what brand of monochrome display to support if P2 (the Monitor Select Jumper) is in the "MONO" position. Levers six, seven and eight are reserved for future use and may be left in any position.

If an RGB or composite monitor is to be used with the Modular Graphics Card (P2 in the "COMP" or "RGB" position) the settings of the levers of S1 will be ignored by the card.

Monochrome display users: Refer to Table 2.2 below. It lists by brand name the appropriate setting of S1 levers one through five for your particular monochrome display. Set them accordingly.

Brand of Monochrome Display	Lever 1	Lever 2	Lever 3	Lever 4	Lever 5
IBM	OFF	OFF	OFF	OFF	OFF
Princeton MAX-12	ON	OFF	ON	OFF	OFF
Roland MB-122 Series	OFF	ON	OFF	ON	OFF
Roland MB-142	OFF	OFF	ON	ON	OFF
Leading Edge	ON	OFF	OFF	ON	ON
Grandwood					
Monochrome	OFF	OFF	OFF	OFF	OFF
AMDEK 310A	OFF	OFF	ON	ON	OFF
ITT Monochrome	OFF	ON	ON	ON	ON

**Table 2.2**  
Switch S1, Levers 1 Through 5 Select Brand of Monochrome Display

**IF YOUR MONOCHROME MONITOR IS NOT LISTED ABOVE, OR IF YOU EXPERIENCE PROBLEMS WITH ROLLING SCREENS, PLEASE REFER TO APPENDIX G FOR DETAILS OF HOW TO DETERMINE THE CORRECT S1 SWITCH SETTING FOR YOUR MONITOR**

## Section 3 — Making Your Computer Ready for the Modular Graphics Card

Several steps must be performed before you install your Modular Graphics Card in your computer system. This section outlines the switch setting procedures required prior to actual physical installation of the Modular Graphics Card in your computer system.

The illustrations that follow are specific to the IBM PC, XT and AT computers, but most PC compatible computers are similar. If you are installing the Modular Graphics Card in a non-IBM system please consult your system user's guide for specifics.

### 3.1 Open Up Your Computer System

Before you open your system, be sure that you have turned off your system unit and all devices connected to it. It is also a good idea to disconnect all cables from the back of the system. This will give you more room to work.

**Step 1:** Figure 3.1 illustrates the location of the cover mounting screws on an IBM PC computer. Older units have only 2 cover mounting screws, newer PC's, XT's and AT units have 5. All cover mounting screws are located on the back of the computer. Remove these screws.

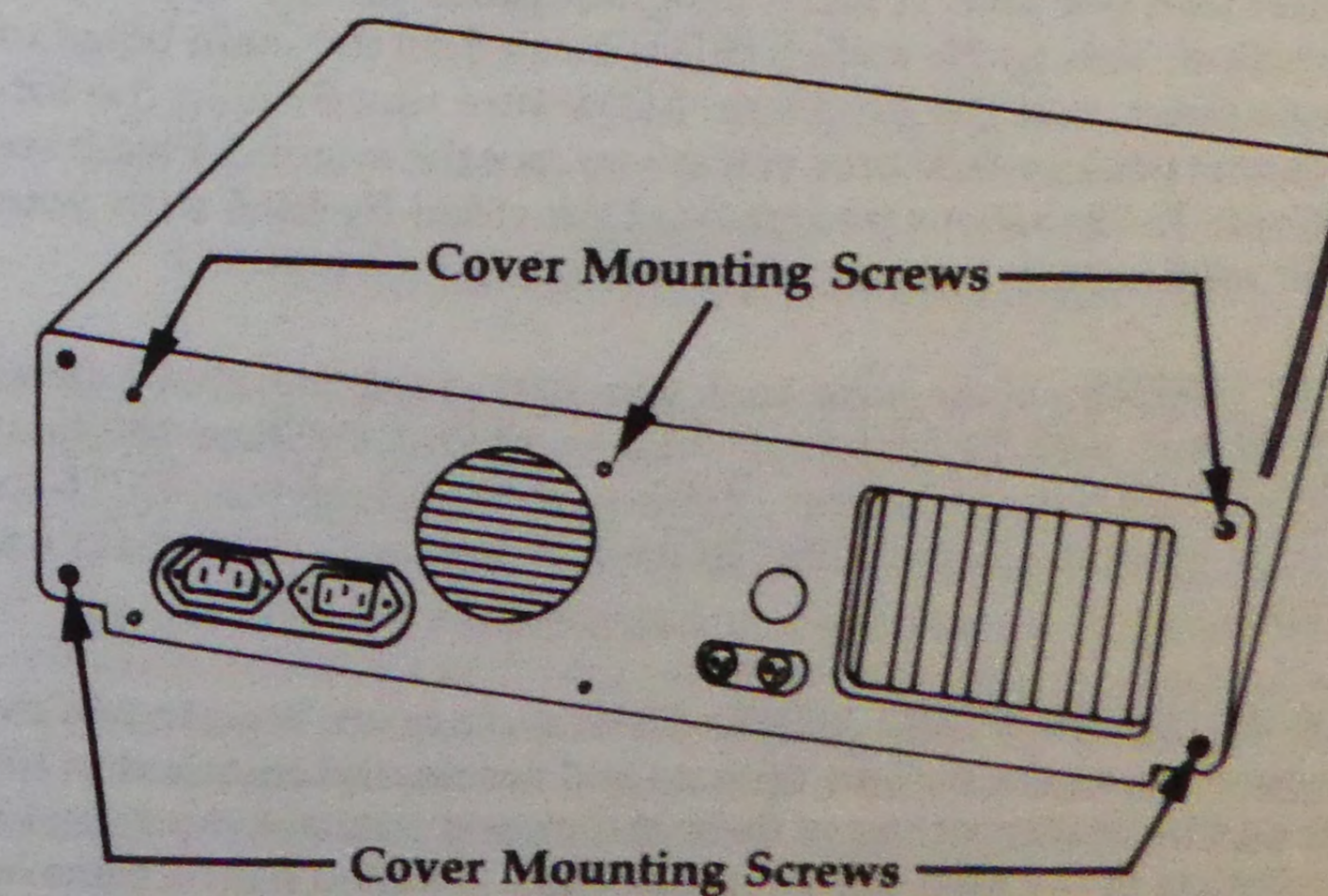

**Figure 3.1**  
Location of Cover Mounting Screws, Back of System

**Step 2:** Carefully slide the system unit cover forward. When the cover will not go any further, tilt it up as shown in figure 3.2 and lift it away.

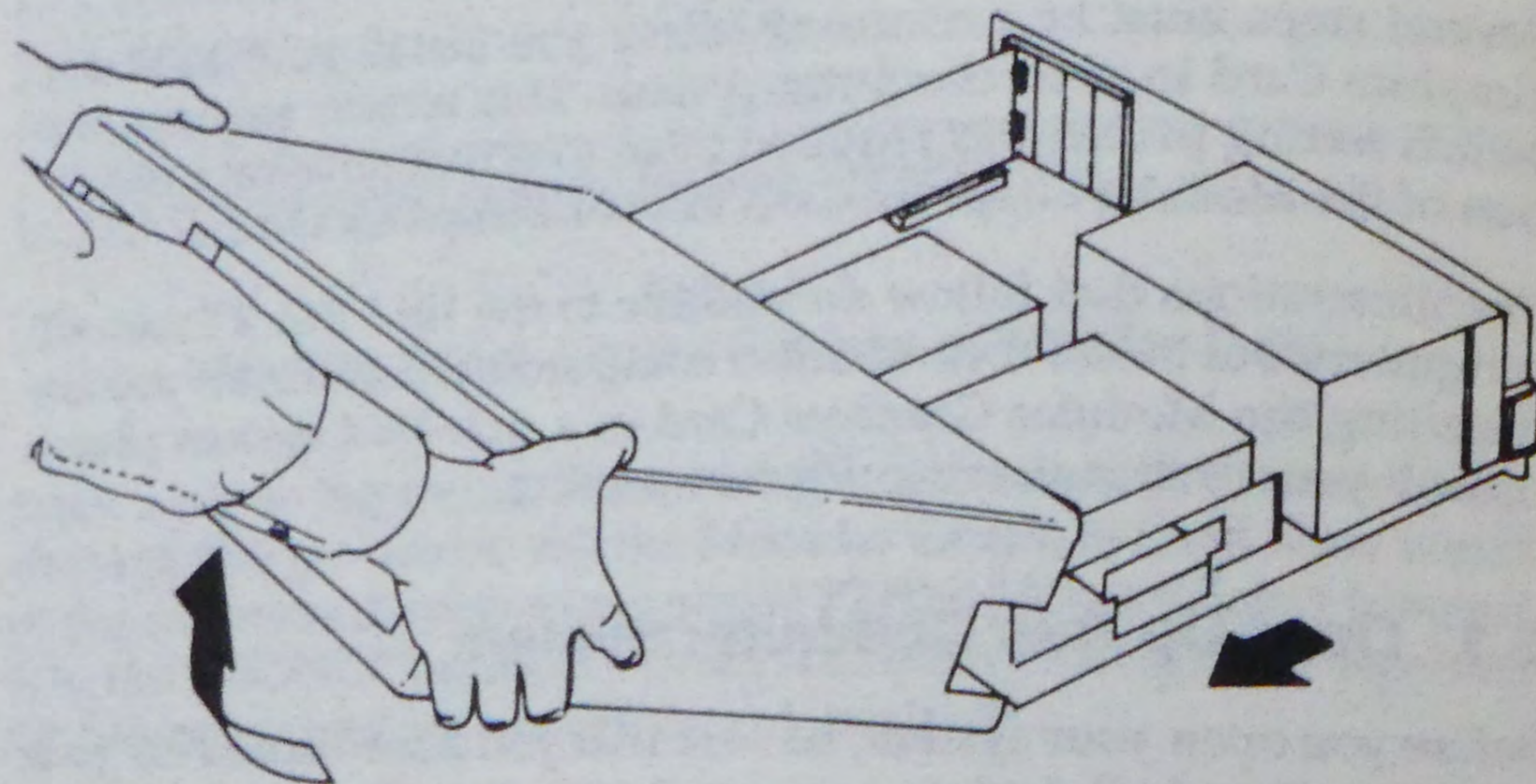

**Figure 3.2**  
Removing the System Unit Cover

### 3.2 Setting Your Computer's System Board Switches

**IBM AT USERS:** Rather than using banks of DIP switches to tell the computer what equipment is installed in your system, the IBM AT computer uses one switch and a program called SETUP to perform this function. This single switch (S1) is located on the main board of your computer near the processor. Make sure that S1 is in the forward (color) position (towards you as you face the system). Please see your *Guide To Operations* (red manual provided by IBM with your system) for the exact location of this switch.

**IBM AT USERS:** Make sure that you have read the above paragraph. If you will be installing add-on modules to the Modular Graphics Card skip the balance of this section and refer to SECTION 4 of this manual. Skip to SECTION 5 if you will not be adding modules.

**PC & XT USERS START HERE:** DIP switches are used to tell the computer about the various options and accessories installed in the system. The proper setting of these switches is critical to a successful installation of the Modular Graphics Card. Detailed instructions on setting DIP switches is available in SECTION 1.4 of this manual.

In the IBM PC, XT and most compatible computers, levers 2, 5 and 6 of switch 1 control the functions that affect the operation of the Modular Graphics Card. Refer to Figure 3.3 (below) for the location of switches 1 and 2. Switch 2 does not appear on the XT system board.

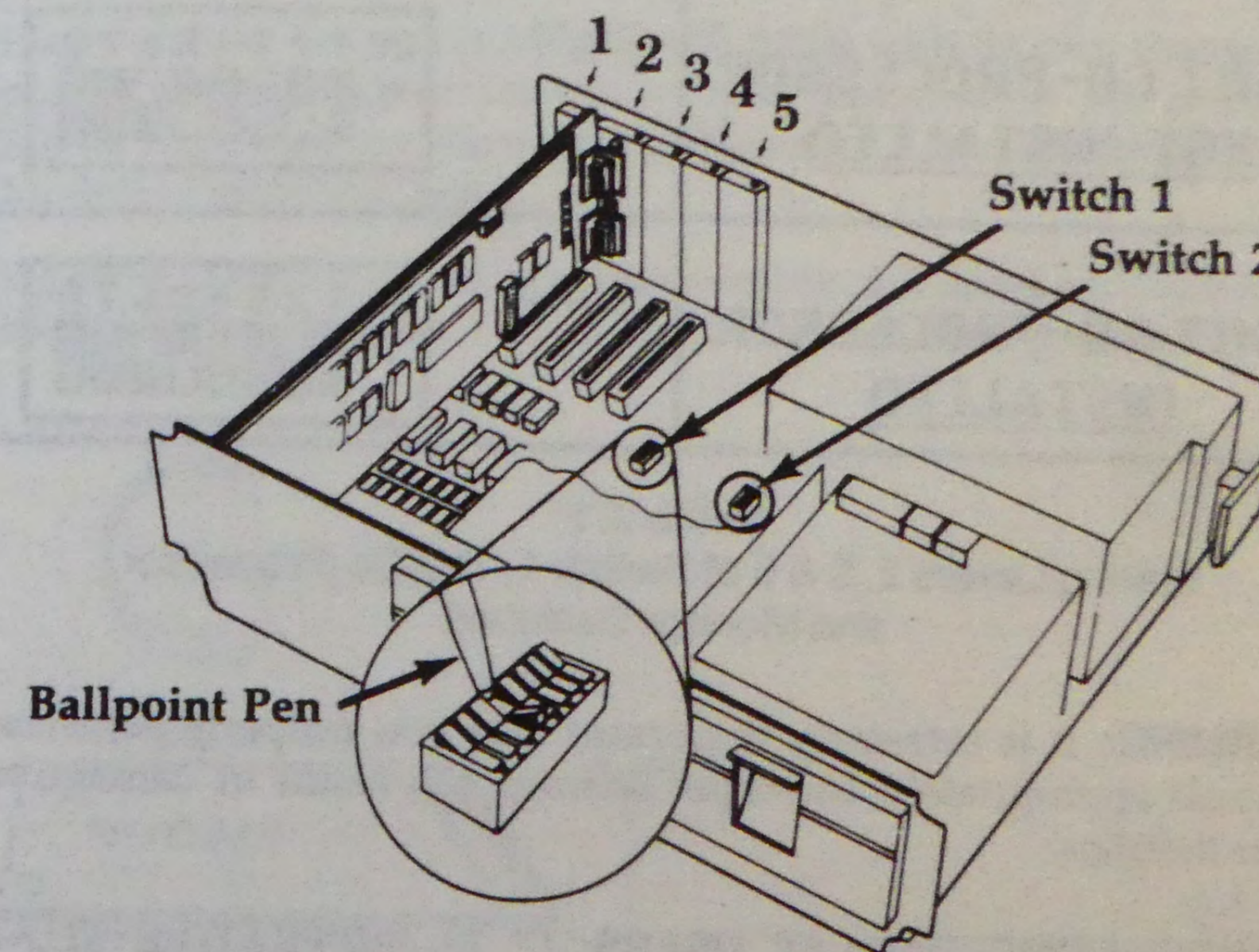

**ALL USERS:** Before you change any switch settings in your computer, please jot down the current settings. If you run into any difficulties, you will then be able to restore your system to its previous operational status.



**Figure 3.3**  
Location of DIP Switches 1 and 2 on the IBM PC

The IBM PC, XT and many compatible computers support the installation of an 8087 co-processor. This device works with the main processor in your computer and shares the computing tasks to be performed by the system. It is important to properly set the switch that tells your system whether such a co-processor is installed. Refer to the documentation that came with your system to determine if you have a co-processor installed in your system. In the IBM PC, XT and most compatibles lever 2 of switch 1 on the computer's main system board tells the system whether or not to expect an 8087 co-processor.

Levers 5 and 6 of Switch 1 tell the system what video adapter card to expect (monochrome or color/graphics). *The Modular Graphics Card should be treated as a color/graphics adapter card regardless of what monitor you intend to use with it.* Refer to Table 3.1 (below). Find the system description that describes your installation and set levers 2, 5 & 6 of Switch 1 as is appropriate.

Do you have an 8087 CO-PROCESSOR?	SET LEVERS 2, 5 & 6 AS SHOWN
<b>8087 CO-PROCESSOR NOT INSTALLED</b>	SW1 
<b>8087 CO-PROCESSOR INSTALLED</b>	SW1 

**Table 3.1**  
Setting Levers 2, 5 & 6 of Switch 1, The Co-Processor and Monitor Switches

**WARNING:** It is extremely important that you properly set these controls appropriately. Improper settings can result in damage to your monitor.

**MONOCHROME DISPLAY USERS:** IT IS IMPERATIVE THAT YOU CONNECT YOUR MONOCHROME DISPLAY ONLY TO THE MODULAR GRAPHICS CARD. YOU MAY, IF YOU WISH, LEAVE AN IBM MONOCHROME DISPLAY ADAPTER IN THE SYSTEM TO BE USED AS A PRINTER PORT ONLY. DO NOT CONNECT A MONOCHROME DISPLAY TO THE IBM CARD UNDER THESE CIRCUMSTANCES. DAMAGE TO THE DISPLAY MAY RESULT.

Your system is now ready to receive the Modular Graphics Card. Be sure that no other color/graphics card resides in the system.

If you wish to install the Modular Graphics Card in a two monitor system, please refer to APPENDIX F of this manual for details of how to accomplish this.

If you wish to install additional function modules to the Modular Graphics Card proceed to SECTION 4 of this manual.

If you will not be installing additional function modules proceed to SECTION 5 of this manual.

## Section 4 — Installing Modules on the Modular Graphics Card

The Modular Graphics Card may be fitted with add-on modules that permit you to add extra functions to the card. These add-on modules come in two varieties: "A" modules and "B" modules. The Modular Graphics Card will accommodate up to one "A" and one "B" module at any given time. A fully configured Modular Graphics Card (A and B modules attached) will use only one expansion slot in your computer system.

Each module that you purchase will come with its own manual explaining the configuration and setup of that module. The steps that follow will detail the physical installation of A and B modules on the Modular Graphics Card.

Figure 4.1 (below) illustrates the assembly of A and B modules to the Modular Graphics Card. Refer to it as needed during assembly.

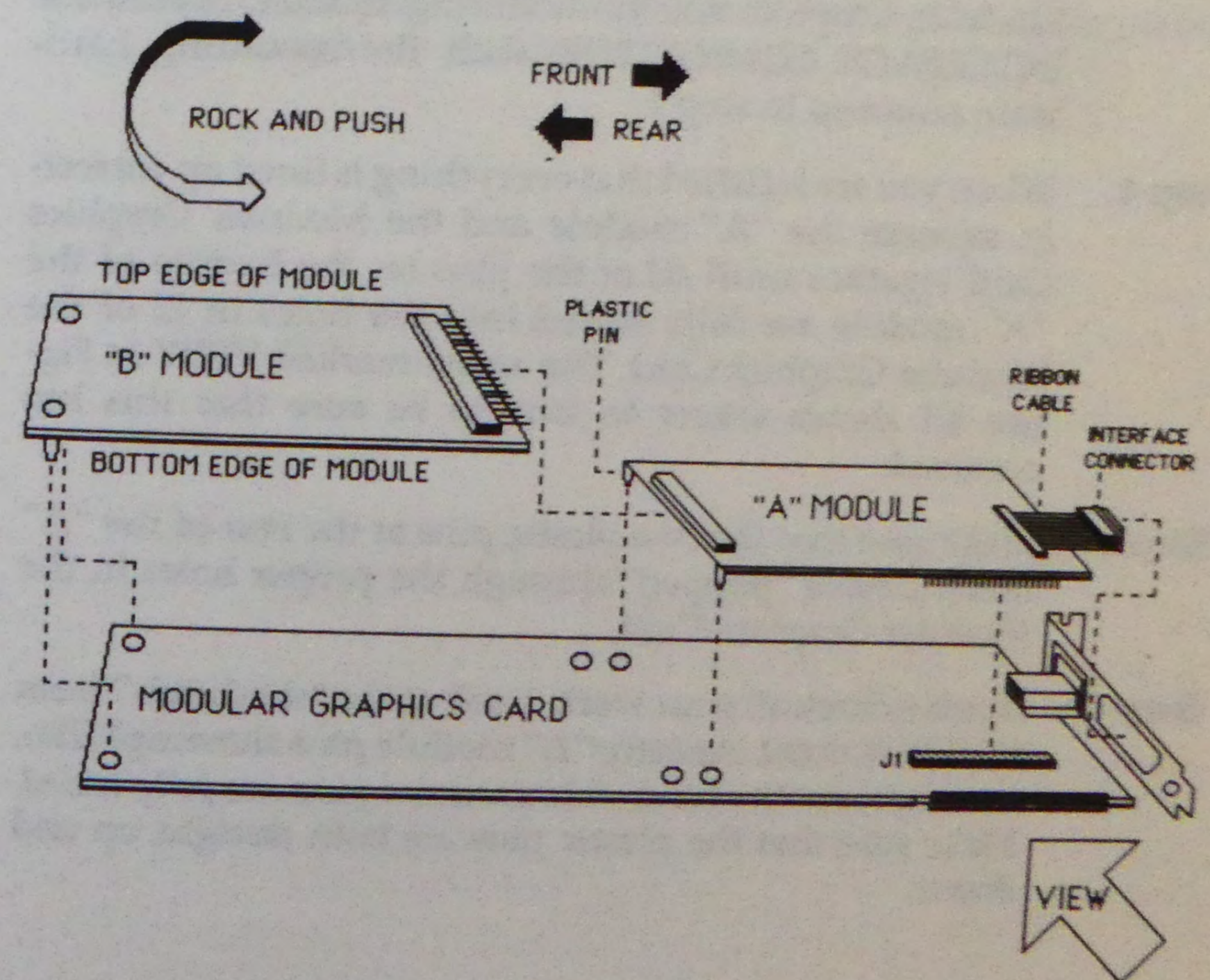

**Figure 4.1**  
Installing A and B Modules on the Modular Graphics Card

## 4.1 Adding an "A" Module

- Step 1.** If your "A" module was shipped with an L shaped mounting bracket (like the one on the Modular Graphics Card) remove it. Save the mounting screws and nuts. If your "A" module was shipped with no mounting bracket remove the mounting screws from the INTERFACE CONNECTOR.
- Step 2.** Place the Modular Graphics Card down on a flat surface. Carefully place the "A" module down on top of the Modular Graphics Card making sure that all of the pins on the lower side of the "A" module fit into the holes in the module connector (J2) on the Modular Graphics Card. Be sure that the two plastic pins on the "A" module line up with the holes on the Modular Graphics Card.
- Step 3.** If your "A" module has an INTERFACE CONNECTOR carefully bend the RIBBON CABLE as necessary and tuck the INTERFACE CONNECTOR through the hole in the Modular Graphics Card's mounting bracket. Secure the INTERFACE CONNECTOR with the mounting hardware removed in step 1.
- Step 4.** When you are satisfied that everything is lined up correctly, squeeze the "A" module and the Modular Graphics Card together until all of the pins on the bottom of the "A" module are fully seated into the holes in J2 of the Modular Graphics Card. The arrow marked VIEW in Figure 4.1 shows where to look to be sure that this has occurred.
- Step 5.** Make sure that the two plastic pins at the rear of the "A" module have "popped" through the proper holes in the Modular Graphics Card.
- Step 6.** Double check all your work. Look at the "sandwich" from the VIEW point. Are any "A" module pins showing? If so, then squeeze the sandwich until the pins are *fully seated*. Make sure that the plastic pins are both straight up and down.

## 4.2 Adding a "B" Module

In order to add a "B" module to the Modular Graphics Card you must first install either an "A" module or a blank "A" module called a bus module.

- Step 1.** Place the Modular Graphics Card (with "A" module installed) down on a flat surface. Line up the the pins in the front of the "B" module with the socket at the rear of the "A" module.
- Step 2.** Ease the "B" module pins into the socket at the rear of the "A" module by applying a "top to bottom edge" rocking action and pushing the "B" module forward into the "A" module. Continue this "rock & push" action until the plastic pins at the rear of the "B" module are lined up with the holes at the rear of the Modular Graphics Card.
- Step 3.** "Pop" the plastic pins on the "B" module through the appropriate holes in the Modular Graphics Card.
- Step 4.** Check your work. Make sure that the plastic pins are both straight up and down and not at an angle.



## Section 5 — Installing the Modular Graphics Card in Your Computer System

### Is the Power Off?

- Step 1.** Refer to Figure 5.1. If necessary, remove a system expansion slot cover by removing its retaining screw and lifting it out. Save the screw.

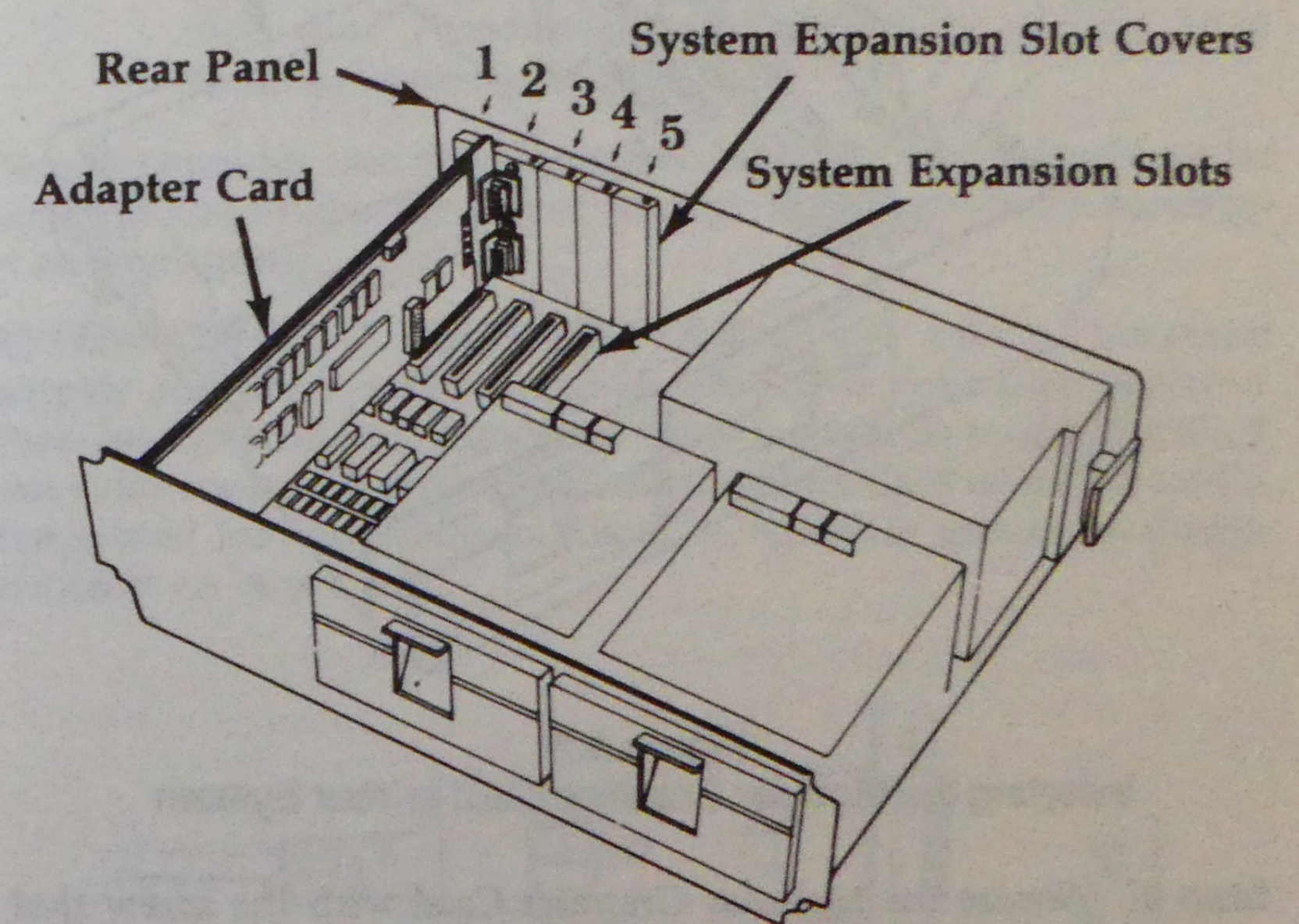

**Figure 5.1**  
Details of Expansion Slots

- Step 2.** Locate the small holes on the inside of your system's front panel in front of the expansion slot you have selected. Snap the plastic adapter guide provided with your Modular Graphics Card into these holes if one is not already installed.

**Step 3.** Hold the Modular Graphics Card by its top corners and slide it into the system unit as shown in Figure 5.2. The front edge of the card fits into the groove in the plastic adapter guide. Make sure that the Modular Graphics Card is *fully* seated in the expansion slot.

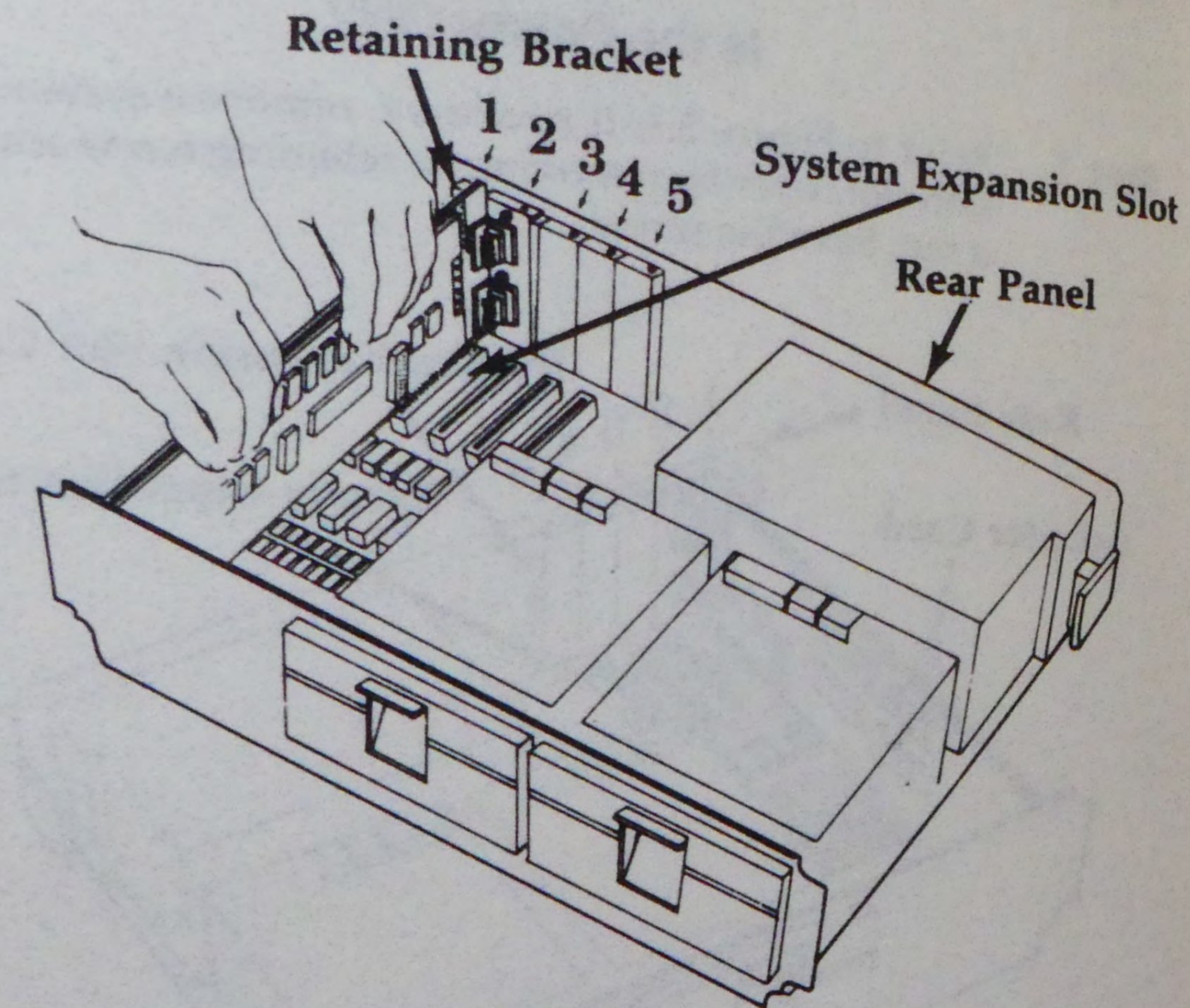

**Figure 5.2**  
Inserting the Modular Graphics Card in Your System

**Step 4.** Secure the Modular Graphics Card with the screw that you removed in step 3.

**Before You Close Up Your System, Check Your Work:**

- Did you properly set the Monitor Select Jumper on the Modular Graphics Card? (See section 2.)
- If using a monochrome display, did you set levers one through four of S1 on the Modular Graphics Card to properly reflect your brand of monochrome display?
- Did you properly set your computer's system switches to accurately reflect the conditions present in your installation? (See section 3.)
- If you installed any additional function modules, are all stand-offs in place and properly aligned? (See section 4.)

- Do you plan to use the supplied RAMDISK software? If so, refer to section 7 of this manual for additional information on system switch settings.

**Step 5.** Replace and secure the system cover with the screws removed in step 1.

**Step 6.** Figure 5.3 (below) illustrates the types of data cables commonly found on monitors compatible with the Modular Graphics Card. IBM monochrome (or equivalent) displays as well as most RGB color displays come equipped with a standard 9 pin connector that will plug directly into the Modular Graphics Card. Composite video monitors will require an adapter available at no charge from either your Paradise Systems Dealer or directly from Paradise Systems, Inc.

Plug the monitor into the nine pin socket at the rear of the Modular Graphics Card either directly or through the composite video adapter as appropriate.

**ATTENTION DO-IT YOUR SELFERS:** If you need a composite adapter and don't wish to wait to obtain one from your dealer or Paradise Systems, Inc., composite video is available on pin 7 of the 9 pin video connector on the Modular Graphics Card when the card is configured for composite monitors. A reference ground is always available on pins 1 or 2.

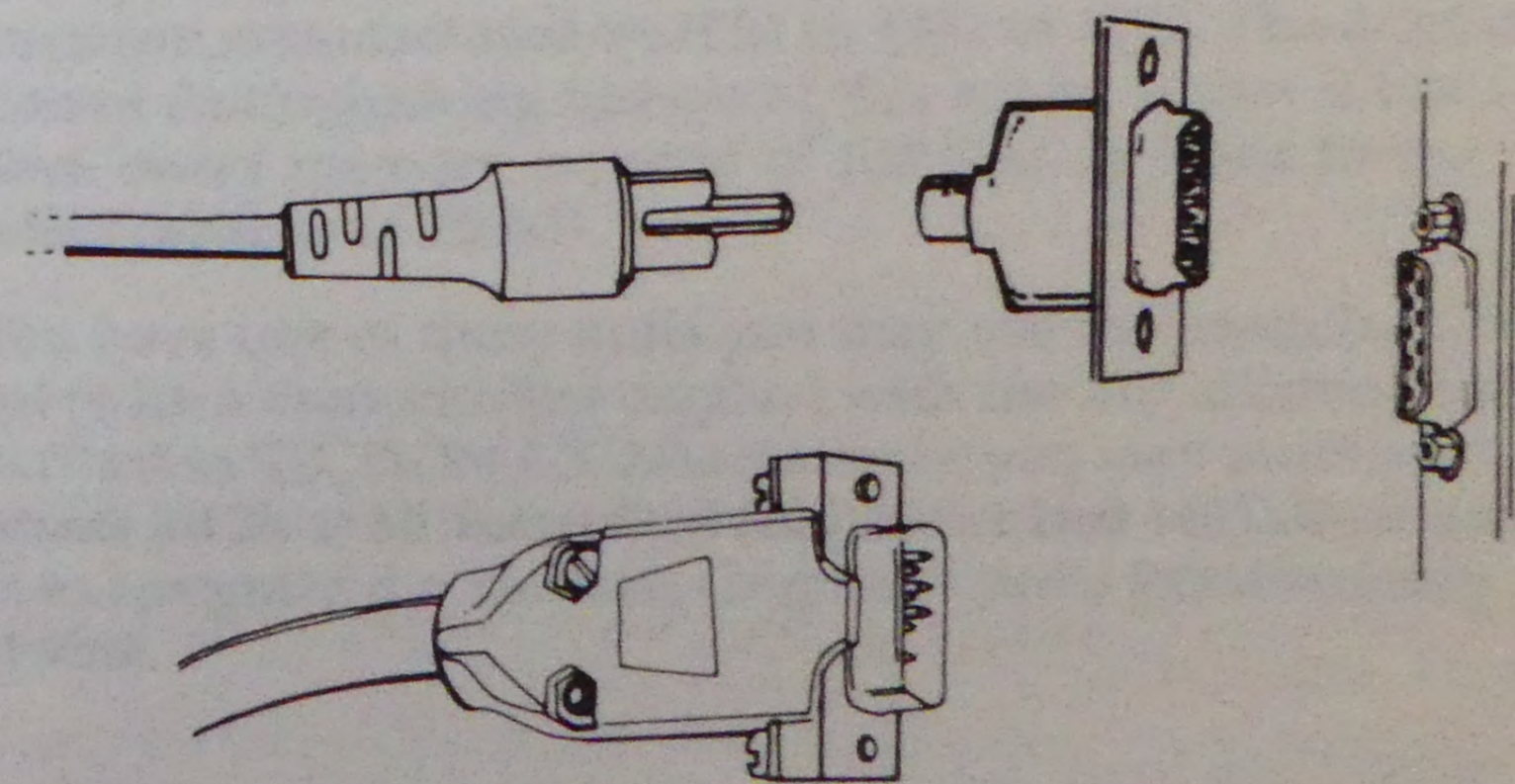

**Figure 5.3**  
Details of Video Connectors and Composite Adapter

**MONOCHROME DISPLAY USERS:** This completes the installation of the Modular Graphics Card. If, when you turn on your system your screen does not clear by the time that the disk drive starts, your system may not recognize the BIOS ROM on the Modular Graphics Card. If this is the case, you will have to install the initialization software described in SECTION 6 of this manual.

Don't forget, the Modular Graphics Card *always* appears to your system as if it were an IBM color/graphics card. Make sure that you configure your application software as necessary.

If you wish, you may turn to sections 7 through 9 of this manual for information on RAMDISK, PRINT SPOOLER and CLOCK software. Otherwise, no special software is needed to use the Modular Graphics Card in the mode you have chosen. If you experience any problems refer to the TROUBLESHOOTING GUIDE at the end of section 6 of this manual.

**COMPOSITE OR RGB DISPLAY USERS:** This completes the actual installation of the Modular Graphics Card. SECTION 6.10 of this manual describes the use of two optional features that may be of interest to you. If you wish, you may turn to sections 7 through 9 of this manual for information on RAMDISK, PRINT SPOOLER and CLOCK software. Otherwise, no special software is needed to use the Modular Graphics Card in the mode you have chosen. If you experience any problems refer to the TROUBLESHOOTING GUIDE at the end of section 6 of this manual.

## Section 6 — Modular Graphics Card Monochrome Initialization Software

**MONOCHROME DISPLAY USERS:** If you are using the Modular Graphics Card with a monochrome display read this section. It contains information you may need to know.

**RGB AND COMPOSITE DISPLAY USERS:** Sub-section 6.10 contains information about two optional features available to you. However, you may skip this section entirely.

### 6.1 An Introduction to Monochrome Operation

When you use the Modular Graphics Card and a monochrome display, the Modular Graphics Card acts in conjunction with monochrome support software resident in a ROM (read only memory) chip on the Modular Graphics Card.

In an IBM PC, XT or AT and most compatible computers this resident software is automatically invoked by the computer's Power-On Self Test software. This means that, if you have an IBM PC, XT or AT computer and you are using a monochrome display, you should be able to use all of the video functions of the Modular Graphics Card without any additional software.

The only exception to this case is one of the very early IBM Personal Computers manufactured by IBM in 1981 or 1982. The most readily apparent distinguishing feature of this model is that it has a main system board memory capacity of 64KB as opposed to the newer model's capacity of 256KB.

If you have one of these units you may use the Modular Graphics Card (with a monochrome display) with the initialization software described in SECTION 6.3. Alternatively, you may purchase a ROM upgrade kit from an authorized IBM dealer that will allow your system to recognize the Modular Graphics Card's ROM resident video software.

## 6.2 Non-IBM Computers and/or Non-IBM Monochrome Displays

**NON-IBM COMPUTERS:** Some brands of "IBM compatible" computers have the ability to recognize and, like the IBM, automatically invoke the ROM resident software on the Modular Graphics Card. The ability to perform this recognition will be evidenced by a clear, readable screen sometime before the disk drive starts during system initialization.

If your system recognizes the Modular Graphics Card's ROM resident software you should not have to perform any software installation. Your installation is complete.

If your system does not recognize the Modular Graphics Card's ROM resident software as evidenced by an inability to get a clear or non-rolling screen image proceed to SECTION 6.3 for details of software installation.

## 6.3 Some Conventions

This section describes the installation of monochrome support software on the disk(s) that you normally use to start your computer system. This procedure is only necessary if your system does not recognize the presence of the ROM resident monochrome support software present on the Modular Graphics Card as evidenced by a failure to achieve a clear screen sometime before the disk drive starts up when you turn on your system.

We have taken several steps to make it easy for you to put the necessary software on the disks that you normally use to start your system.

The sections that follow will give you specific instructions relating to the set up of disks you will use to start your computer. The information that you must type into your computer will appear in a special typeface that looks like this:

### THIS IS WHAT YOU TYPE

Specific keys such as the `RETURN` key will be enclosed in a box.

Example: Type the word "INSTALL" then the letter name of the disk drive containing the diskette or hard disk upon which you wish to install the monochrome initialization software. Then hit the "RETURN" key on your computer's keyboard:

```
INSTALL B: RETURN
```

## 6.4 Installing the Monochrome Initialization Software

### 6.4.1 Floppy Disk System Users:

- Step 1.** Insert the Paradise diskette in drive A and turn on your computer system. At this point your monochrome screen may be rolling and/or showing half height characters. This is normal and will be corrected as soon as the disk starts. After a few moments the disk drive will start, the screen will clear, and you will be presented with two choices: to start DOS by typing a 1 or to start Diagnostics by typing a 2.
- Step 2.** Remove the Paradise diskette from drive A and replace it with a working copy of your DOS disk or any non-write protected, DOS formatted disk that you normally use to start your system. If you don't have such a disk available insert the original of your DOS disk. However, if you start with an original (write-protected) copy of DOS, you will have to create a new formatted system diskette before you continue. Please see your DOS manual for details.
- Step 3.** Type: 1 This will start DOS. Depress the `RETURN` key twice to get by any date and time prompts. You should now be presented with the DOS prompt, (A>).
- Step 4.** Replace your DOS disk with the Paradise disk, place your destination disk (the one upon which you wish to install the software) in drive B and type the following:

```
INSTALL B: RETURN
```

**Help is available:** Type the word: `INSTALL` `RETURN` and you will be presented with some on-screen help messages.

**Single drive system users:** If you have a single drive system you will be prompted to alternately insert the Paradise disk (for drive A) and your destination disk (for drive B).

When the `INSTALL` program has finished you may make the same installation on another disk by pressing the `F3` key, inserting a new destination diskette and pressing `RETURN`. When you are finished preparing diskettes, "powerdown" (turn off) your system and restart with the disk on which you just installed the Modular Graphics Card software.

The diskette that you just prepared now contains initialization software appropriate for your computer system. This software will execute automatically each time you start your system with this diskette, requiring no intervention from you.

### 6.4.2 Hard Disk System Users:

**PLEASE NOTE:** The following procedures assume that your hard disk has been formatted and installed so that it is possible to start your system in DOS from the hard disk. If this is not the case, refer to section 6.4.1 for information on creating a floppy diskette to be used until you have set up your hard disk.

- Step 1.** Insert the Paradise disk in drive A and turn on your computer system. At this point, your monochrome screen may be rolling and/or showing half height characters. This is normal and will be corrected as soon as the disk starts. After a few moments the disk drive will start, the screen will clear and you will be presented with two choices: to start DOS by typing a 1 or to start diagnostics by typing a 2.
- Step 2.** Open the disk drive door and type 1. This will allow your system to start DOS.
- Step 3.** Depress the `RETURN` key twice to get beyond any date and time prompts. You should now be presented with the DOS prompt. Type `A: RETURN`. This will make the A drive the default drive, the DOS prompt should now be `A>`.
- Step 4.** If you have not already done so, place the Paradise supplied diskette in the "A" drive and close the drive door. Type the following phrase:

```
INSTALL <hard disk drive letter> RETURN
```

In place of <hard disk drive letter> type its letter designation followed by a colon. Most hard disks are called C:.

Here is an example: Installing for a hard disk called C, type:

```
INSTALL C: RETURN
```

Help is available: Just type the word: `INSTALL RETURN` and you will be presented with some on-screen help messages.

Your hard disk now contains initialization software appropriate for your computer system. This software will execute automatically each time you start your system with no intervention from you.

### 6.5 Configuring Your Application Software

Many application software packages contain installation programs or menus that allow or require you to tell it what kind of video adapter and/or what kind of monitor you are using.

**THE MODULAR GRAPHICS CARD ALWAYS LOOKS TO YOUR SYSTEM AS IF IT WERE AN IBM COLOR/GRAPHICS ADAPTER.** You must keep this in mind when you install software for use with the Modular Graphics Card.

If you have replaced your IBM Monochrome Display Adapter with the Modular Graphics Card chances are that much of your application software is configured for the monochrome card and won't work with the Modular Graphics Card until it is re-installed for "color." Refer to the manuals that are provided with your application software for details.

### 6.6 Special Notes for Those Who Use Monochrome Initialization Software

It is not always possible to install our initialization software on every application diskette. There are several reasons for this:

1. There is no room left on the diskette for our files. Although our software requires only 2KB (maximum) of diskette space, some software producers have had to use all of the available space on their diskette. The solution is to start your system with another diskette that has our software on it, then replace your startup diskette with your application diskette and type the application name.
2. Copy protection schemes. Many entertainment applications such as Microsoft's Flight Simulator, are provided on diskettes that have special formatting that will not allow you put any new files on the disk. Some of these applications may only be started by "booting", or starting from a power-off condition, or from a system reset.

We have made provisions for this in our software. Simply start your system from your floppy or hard disk. Once our software has run, you may then:

- A. Insert your application disk in drive A.

**B.** Perform a system reset. (Press the DEL key while holding down the CTRL & ALT keys.) You will be prompted for a hard reset (H) or a soft reset (S). Press the S key. This will restart the disk while leaving our software resident and active in your system. Pressing H will reset your system as if you had performed a normal system reset.

**3.** A few applications are equipped with copy protection schemes that are destructive in nature to resident software like ours. A further step must be taken in order to run these applications.

**A.** Start your computer system from the diskette supplied with the Modular Graphics Card.

**B.** When prompted to insert a DOS disk or a Diagnostics disk insert your application disk into the A drive, close the door, and press 1.

## 6.7 Troubleshooting

Here are some typical symptoms and solutions to installation problems:

Symptom	Solution
One long "beep" and two short "beeps" shortly after powerup.	Lever 5 & 6 of Switch 1 of system board are probably set for monochrome rather than for color. Set 5 ON, 6 OFF. SEE SECTION 3 OF THIS MANUAL FOR MORE DETAILS.
Screen may or may not clear and/or message is displayed "Paradise requires a Modular Graphics Card in order to work."	Lever 2 of Switch 1 of system board is probably set inappropriately for the presence or absence of 8087 co-processor. SEE SECTION 3 OF THIS MANUAL FOR MORE DETAILS.
SAME AS ABOVE	Check to see if gold "fingers" on the connector that plug into computer are dirty. Shine with pencil eraser and wipe clean with cloth.
SAME AS ABOVE	Incompatible computer. Computer must have parity-checked memory, see your DEALER.

Screen does not clear after disk starts.

SAME AS ABOVE

Check to see if you are indeed using a monochrome display.

Software not installed. SEE SECTION 6 OF THIS MANUAL FOR DETAILS.

SAME AS ABOVE

The monitor select jumper is in the wrong position. SEE SECTION 2 OF THIS MANUAL FOR DETAILS.

Screen completely dead

Is monitor connected to OUR card? Several types of cards have the same connector. Are the BRIGHTNESS and CONTRAST controls adjusted properly?

SAME AS ABOVE

Do you own an AMDEK 310A or Quadram Amberchrome monitor? SEE APPENDIX D FOR DETAILS OF POTENTIAL PROBLEMS WITH THESE MONITORS.

Screen rolls in one or more modes. (May also appear as a split screen.)

PLEASE REFER TO SECTION 6.8 (BELOW) FOR SPECIFIC INSTRUCTIONS.

Erratic operation in 40 column text or graphics modes, 80 column text mode OK.

Lever 2 of SW1 (co-processor switch) not properly set. SEE SECTION 3.2 FOR DETAILS.

## 6.8 Screen Rolling

If you have followed the manual so far you probably set the monitor select switches on the Modular Graphics Card according to the table in section 2. Due to slight differences in the quality control levels of some monochrome displays, there will be an occasional monitor that will exhibit a rolling screen in graphics mode. If you experience such a rolling problem in graphics mode, please refer to Appendix G of this manual for details of how to set your Modular Graphics Card for your specific monitor installation.

## 6.9 Rolling Screen with a Particular Software Program

The first thing you must do when you have problems with a particular software package is to make sure that you have installed that package for a color/graphics card rather than a monochrome display adapter. A survey of technical support calls received by Paradise Systems indicates checking this will solve over 50% these problems.

When you use the Modular Graphics Card with a monochrome display, operation depends on the continued integrity of the resident software that is loaded whenever you start your computer. The standard installation of our video support software (the software that is put on your disk by the INSTALL program) will support most applications that you may wish to run on your computer.

Sometimes an application is written in such a way that it will not tolerate the presence of a resident program like our video support software. This conflict may manifest itself as a rolling screen or just by an inability to run a particular program.

The supplied file PARADISE.COM may be used in special cases to modify the way in which the monochrome initialization software resides in your computer. Help screens describing the use of PARADISE.COM are available on-line while using the program. At the DOS prompt (A>), insert the Paradise diskette in drive A: and type:  
PARADISE HELP

## 6.10 Some Options for RGB and Composite Users

The supplied diskette file SCREEN.COM may be used to control two features of the Modular Graphics Card that are available when you are using composite or RGB monitors.

When you use either a composite or RGB monitor with the Modular Graphics Card, the operation of the Modular Graphics Card is identical to that of the IBM color/graphics card. However, like the IBM product, the Modular Graphics Card exhibits a "flicker" during scrolling. Unlike the IBM product, the Modular Graphics Card has the facility to turn this flicker OFF or ON at will.

This flicker is considered by most to be very annoying and you will probably want to turn it off. There are, however, several software packages that take advantage of this "facility" and that is why we have elected to leave it as THE DEFAULT CONDITION of the Modular Graphics Card.

The public domain program, SCRNSAVE.COM, is a program that turns off the screen after no keystrokes have been received by the computer for a specified period of time. It takes advantage of the "flicker facility" in both the IBM color/graphics card and our card. Several other commercially available programs take advantage of this facility of our card.

To turn the flicker on or off put a disk containing SCREEN.COM in the default (current) disk drive and type:

SCREEN FLICKER   
OR  
SCREEN NOFLICKER

If you are using a black and white composite monitor, you may also wish to suppress color information going to your monitor. This will produce a better image on the screen. SCREEN.COM also provides this facility. Type:

SCREEN BW   
OR  
SCREEN COLOR

The Modular Graphics Card provides these options only with RGB and composite monitors. When you start your system the Modular Graphics Card will come up with both FLICKER and COLOR ON.

## Section 7 — Ramdisk Software

### 7.1 What is a Ramdisk and What Can it do for Me?

The diskette provided with the Modular Graphics Card contains an advanced disk emulation program called RAMDISK.COM. It allows you to treat a portion of your system's memory as though it were one or more disk drives in addition to those actually installed in your system.

A ramdisk can provide temporary storage for your programs and/or data that is fast and reliable. A ramdisk can make a one disk drive system "look" as if it were a two drive system by providing a second drive in memory. By copying your programs and data to a ramdisk, you can significantly speed up disk operations.

There are advantages and disadvantages to using ramdisks that you should be aware of before using them.

#### **Advantages:**

Ramdisks are fast. A ramdisk is really your computer's system memory and not a mechanical device like an actual disk drive.

Ramdisks are reliable. They are reliable for the same reasons that they are fast. There are no moving parts and no media to wear out.

#### **Disadvantages:**

Ramdisks are "volatile." This means that they are only temporary devices. Their existence depends on the continued normal operation of your computer system. If the power goes off, your ramdisk (and its contents) will disappear. If you put some information on a ramdisk and then run a program that takes over the whole computer (like Microsoft's Flight Simulator), don't expect your ramdisk to be around when you are through flying.

Ramdisks use system memory. This means that any memory you allocate to the ramdisk will be subtracted from the amount of memory available for the operating system and/or your application programs.



## 7.2 Compatibility of Ramdisk Software

The supplied ramdisk software is designed to operate with IBM PC DOS version 2.0 or later on IBM PC and XT computers. It may also work on earlier versions of PC DOS or with the operating systems supplied with many PC compatibles. Operation on non-IBM equipment and/or non-IBM DOS is not supported by Paradise Systems.

The supplied ramdisk software is designed to run with most normal DOS applications such as spreadsheets, word processors, databases, editors and compilers. However, you should test the specific program you wish to use on a ramdisk with sample data.

## 7.3 Copying the Ramdisk Software to Your Working Diskette

All of the features and functions of the Modular Graphics Card ramdisk software are contained in the file called RAMDISK.COM. This file is not copy protected in any manner and may be copied to a working copy of your DOS diskette (not your original) or any other working or archive diskette you choose.

You may copy RAMDISK.COM and any of the other supplied files with the COPY command in DOS. The following steps outline how to copy RAMDISK.COM to another disk. If you are new to PC DOS please take some time to read the sections in your DOS manual dealing with the COPY command.

### Floppy Disk System Users:

- Step 1.** Start your computer system with a working copy of your DOS diskette. This disk should have at least 5KB of unused space and should not have a tab over its write-protect notch.
- Step 2.** Press the `RETURN` key twice to get past the DATE and TIME prompts if necessary. When you have the DOS prompt (`A>`), insert the Paradise diskette in drive B. (If you have a one drive system you will be prompted when to insert the Paradise diskette in the A drive.)

- Step 3.** Type the following: `COPY B:RAMDISK.COM RETURN`. This will copy the ramdisk software to the diskette in drive A. Users of single drive systems will be prompted to "Insert the disk for drive B:" during the copy process. This is the time to insert the Paradise diskette in the drive. By the same token, when you see the prompt "Insert the disk for drive A:", re-insert your DOS or working disk.

### Hard Disk System Users:

- Step 1.** Start your system in DOS as you normally do. You may start either from a floppy diskette or the hard disk.
- Step 2.** Make your hard disk the active (default) drive by typing its drive letter and a colon (usually C:) followed by `RETURN`.
- Step 3.** Insert the Paradise diskette in drive A: and type: `COPY A:RAMDISK.COM RETURN`.

You now have a working copy of RAMDISK.COM on your working diskette or hard disk. Place the Paradise diskette in a safe place. You should not use the supplied diskette for day to day operations.

## 7.4 Making Your System Ready to Use Ramdisk Software

If you have not made a working copy of your ramdisk software yet, go back to section 7.3 and do so now.

In order to use one or more ramdisks in your computer, the system must be prepared to recognize the extra disk drive(s) that will be created by the ramdisk software. This procedure will only be performed once.

Because a ramdisk appears to the computer system as though it were a real floppy disk drive, the system switches that control how many disk drives are active, need to be set to anticipate your ramdisk usage.

Levers 7 and 8 of SW1 on the main system board of all IBM PC and XT computers control this function. Refer to Figure 7.1 for the location of SW1 on the IBM PC and XT computers. (This figure also shows the location of SW2 which exists only on the PC and not on the XT.)

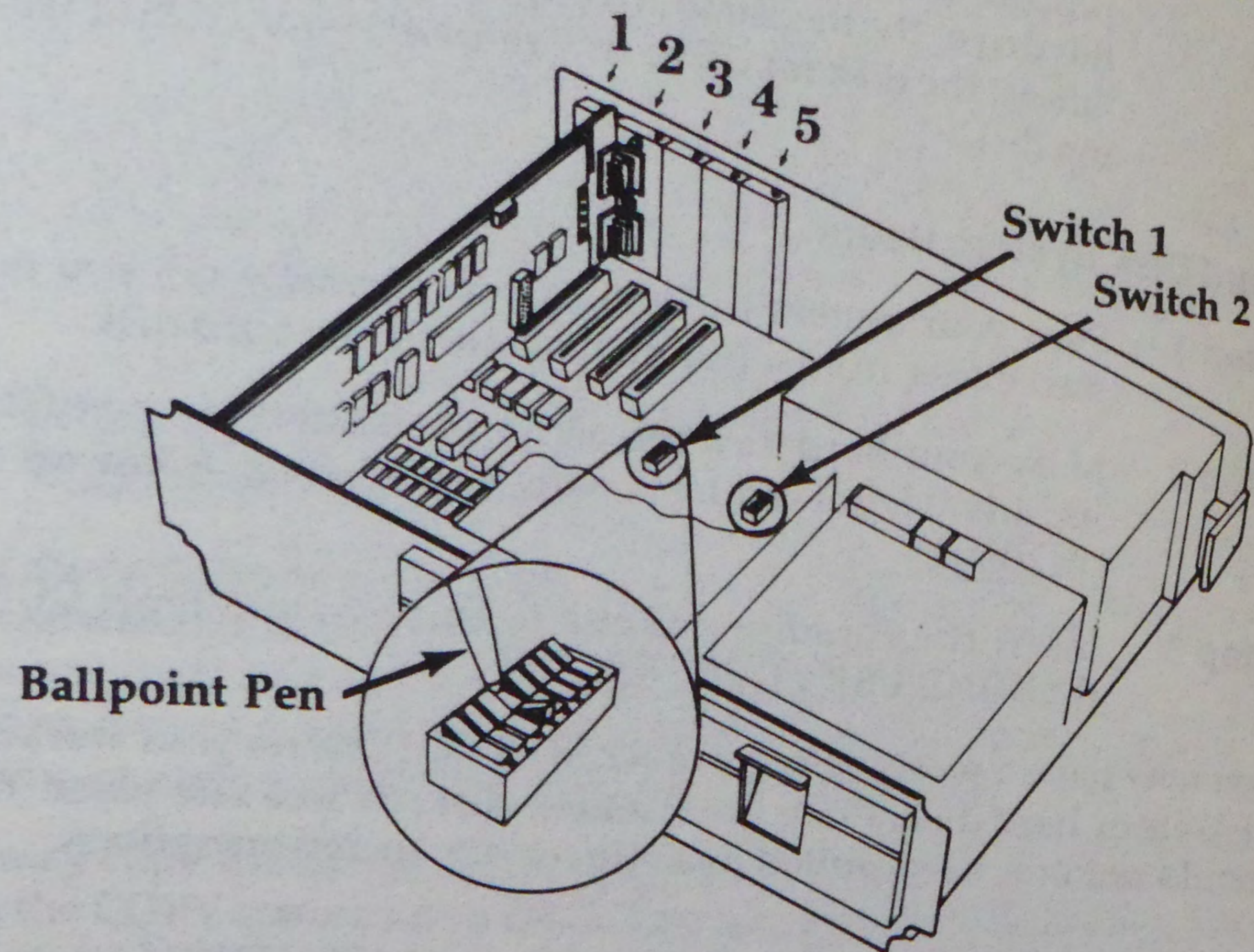

**Figure 7.1**  
Location of DIP SWITCHES 1 & 2 on the IBM PC

These switches may be set to reflect up to 4 drives. If you have a system with one disk drive you may have up to 3 ramdisks in your system. If you have two disk drives in your system you may have up to 2 ramdisks in your system.

Table 7.1 illustrates the settings of levers 7 & 8 on SW1 and what they mean.

SW1 Levers		Total Drives in System(*)	Possible Diskette and/or Ramdisk Names
7	8		
ON	ON	1	A (1 DISK DRIVE, NO RAMDISKS)
OFF	ON	2	A B (DISK & 1 RAMDISK OR 2 DISK DRIVES)
ON	OFF	3	A B C (ANY 3 WITH AT LEAST 1 DISK DRIVE)
OFF	OFF	4	A B C D (ANY 4 WITH AT LEAST 1 DISK DRIVE)

**Table 7.1**  
Setting Levers 7 & 8 of Switch 1, Disk Drive Switches

(\*) The total number of drives in your system excludes fixed disks such as those found in the IBM XT. However, if you set these switches to indicate that you have more than two drives in an IBM XT, DOS will change the fixed disk drive name to the next available name. For example, an XT with switches set for 1 or 2 diskette drives will call its fixed disk C:. If you set the switches for 3 drives it will call its fixed disk D:, and so on.

You may leave the system switches set for more drives than you actually use. For example, you can set your switches to indicate 4 drives and you may actually have 1, 2, 3 or 4 drives. If you try to access a drive name that is not either a disk drive or a ramdisk, you will receive an error message from DOS and be given the option to abort the procedure.

If you wish to run the diagnostics supplied with your computer, re-set the system board switches to reflect the actual number of drives in your computer.

**Single Disk Drive Users:** If you set your system switches to reflect more than the actual number of installed drives DOS can no longer treat the one actual drive in your system as two logical drives. You may use DISKCOPY with one logical drive (A:) as both the source and target disks by invoking it with the following syntax: DISKCOPY A: A: rather than the usual DISKCOPY A: B:. You may use a ramdisk as an intermediate holding media when you wish to transfer files between diskettes.

## 7.5 Starting the Ramdisk Software

Before you attempt to start using your ramdisk software please be sure you have read the previous portions of this section of the manual. The following instructions assume that you have set your system switches according to the instructions in this section, that you have started your system with DOS and that the current (default) drive contains a copy of RAMDISK.COM.

Like any other program that you run on your system, the ramdisk software must be invoked each time you turn on your system (provided that you wish to use a ramdisk). Once invoked, ramdisks remain resident until you turn off the system or do a system reset.

To invoke the ramdisk program you must type the program name RAMDISK followed by one or more parameters. These parameters tell the program how you want to set up your ramdisk(s). The following format should be used:

```
RAMDISK <DISK NAME> <DISK SIZE> 
```

Where <DISK NAME> is the phrase A:, B: etc. and <DISK SIZE> is a number from 10 to 360 indicating how much system memory in KB to allocate to the ramdisk. Here is an example of how to create a ramdisk called C: that can hold 100KB of information. At the DOS prompt, type:

```
RAMDISK C: 100 
```

You may have up to 3 ramdisks in your system at one time. If you wish to invoke more than one you must do so all at once. Here is an example of how to create 3 100KB ramdisks called B: C: and D:.

```
RAMDISK B: 100 C: 100 D: 100 
```

If you omit the <DISK SIZE> parameter the program will pick a size for you.

Please Note: Care should be exercised in choosing ramdisk sizes as every KB of memory you allocate to a ramdisk is subtracted from the amount of memory available for your application programs and DOS. Memory resident programs, such as SIDEKICK and Spotlight also need their share of memory space, so plan carefully.

**Help is Available:** If you invoke RAMDISK without any parameters a help screen will be displayed.

## 7.6 Using Ramdisks

Once you have successfully installed your ramdisks they may be treated as if they were actual disk drives with the following exceptions:

- A. Do not use the DOS FORMAT command on a ramdisk. Ramdisks are automatically formatted when you create them.
- B. If you invoke a ramdisk that is not a standard DOS size (160KB, 180KB, 320KB or 360KB) the difference between the size that you choose and the next largest standard DOS size disk will be reported as "Bad Sectors" by the DOS CHKDSK command. This is normal.

## Section 8 — Print Spooler Software

### 8.1 What is a Print Spooler and What Can it Do for Me?

Generally, a computer system is only as fast as its slowest component. The speed of your computer's processor may be measured in thousands of instructions per second; but if your printer can only print at 80 characters per second then that is as fast as your system will go while you are printing a document.

When a device external to the processor in a computer system is the limiting factor in system throughput (how much you can get done), your system is what is known as "I/O Bound."

It's a fact that most of the time your computer system is doing very little. It spends most of its time waiting for someone to press a key at the keyboard.

A print spooler takes advantage of this situation by "stealing" a little of this "idle" time from the processor and using it to manage the flow of information to the printer.

The print spooler intercepts all information going to the printer and stores it in a portion of system memory that has been set aside for this purpose. Meanwhile, it is telling the computer to keep sending information at full speed while it parcels out this information to the printer at a speed that the printer can cope with.

In terms of what the computer is capable of, this is not a particularly demanding task and the computer can generally manage a print spooler and a normal application program without any apparent loss of performance in the application program.

### 8.2 Compatibility of Print Spooler Software

The supplied print spooler software is designed to operate with IBM PC DOS version 2.0 or later on IBM PC and XT computers. It may also work on earlier versions of PC DOS or with the operating systems supplied with many PC compatibles. Operation on non-IBM equipment and/or non-IBM DOS is not supported by Paradise Systems.

The supplied print spooler software should run with most normal DOS applications such as spreadsheets, word processors, databases, editors and compilers. However, some application programs send information to be printed directly to the hardware that connects to your printer without using the facilities of DOS. A program like that can not take advantage of the print spooler.

### 8.3 Copying the Print Spooler Software to Your Working Diskette

All of the features and functions of the Paradise print spooler software are contained in the file called SPOOL.COM. This file is not copy protected and may be copied to a working copy of your DOS diskette (not your original) or any other working or archive diskette you choose.

You may copy SPOOL.COM and any of the other supplied files with the DOS COPY command. The following steps will outline how to copy SPOOL.COM to another disk. If you are new to PC DOS please take some time to read the sections of your DOS manual pertaining to the COPY command.

#### Floppy Disk System Users:

- Step 1.** Start your computer system using a working copy of your DOS diskette. This disk should have at least 5KB of unused space and should not have a tab over the write-protect notch.
- Step 2.** Press the **RETURN** key twice to get beyond the DATE and TIME prompts if necessary. When you have the DOS prompt (A>), insert the Paradise diskette in drive B. (If you have a one drive system, you will be prompted when to insert the supplied diskette in the A drive.)
- Step 3.** Type the following: **COPY B:SPOOL.COM RETURN**. This will copy the print spooler software to the diskette in drive A. Users of single disk drive systems will be prompted to "Insert the disk for drive B:" during the copy process. This is the time to insert the Paradise diskette in the drive. By the same token, when you see the prompt "Insert the disk for drive A:" re-insert your DOS or working disk.

#### Hard Disk System Users:

- Step 1.** Start your system in DOS as you normally do. You may start either from a floppy diskette or the hard disk.
- Step 2.** Make your hard disk the active (default) drive by typing its drive letter and a colon (usually C:) followed by **RETURN**.
- Step 3.** Insert the Paradise diskette in drive A: and type:

**COPY A:SPOOL.COM RETURN**

You now have a working copy of SPOOL.COM on your working diskette or hard disk. Place the Paradise diskette in a safe place. You should not use the Paradise diskette for day to day operations.

### 8.4 Starting the Print Spooler

Before you attempt to start using your print spooler software, please be sure you have read the previous portions of this section of the manual. The following instructions assume that you have started your system with DOS and that the current (default) drive contains a copy of SPOOL.COM.

Like other programs that run on your system, the print spooler software must be invoked each time you turn on your system (provided that you wish to use a print spooler). Once invoked, the print spooler remains resident until you turn off the system or do a warm boot.

To invoke the print spooler program you must type the program name SPOOL followed by one or more parameters. These parameters tell the program just how you want to set up your SPOOLER. This is the format you should use:

**SPOOL <DEVICE> <BUFFER SIZE> RETURN**

<DEVICE> should be one of the following phrases: LPT1, LPT2, LPT3, COM1 or COM2. These are the names that DOS assigns to devices connected to the parallel printer ports and to the serial ports in your system. Normally, use LPT1 as the device name. This will work in 99% of all systems. If you have a serial printer see the subsection below titled **SERIAL PRINTER USERS**.

<BUFFER SIZE> is a number from 1 to XXX indicating how much system memory in KB to allocate to the print spooler.

Here are some examples of ways to invoke the print spooler:

```
SPOOL LPT1 100K RETURN
```

```
SPOOL LPT1 RETURN
```

```
SPOOL 70 RETURN
```

```
SPOOL RETURN
```

(parallel, 100KB buffer size)  
(parallel, 64KB buffer size if size unspecified)  
(70KB buffer, selects LPT1 if it exists, COM1 if it doesn't)  
(displays current spooler status)

If you are printing letters and memos 32KB should be enough buffer space. A full page of printing requires about 6KB of buffer space so an allocation of 64KB should easily handle most 10 page documents.

At any time after you have invoked the print spooler, you may type `SPOOL RETURN` from the DOS prompt. The spooler will respond with a status report and a list of additional commands that are active while the print spooler is invoked. This is an example of that report:

```
Paradise Systems Spooler - Version 1.00  
(C) by Paradise Systems, Inc. 1985
```

```
** Installed **
```

```
Using parallel port LPT1  
64K character spooling buffer, no characters in its backlog  
418K byte program work area  
Print spooling is currently on
```

The following commands are valid when the spooler is active:

```
SPOOL OFF          — Stops printing, but continues to save  
                   print data  
  
SPOOL ON           — Restarts printing  
SPOOL PAGE        — Stops printing after next form feed to  
                   allow paper reload  
                   Use "SPOOL ON" to restart after paper is  
                   changed  
SPOOL CLR         — Get rid of all data that hasn't been sent  
                   to printer yet
```

**Help is Available:** If you invoke `SPOOL` without any parameters, a help screen will be displayed.

**Serial Printer Users:** Although the print spooler may be invoked and associated with a COM (serial) port, it will still be necessary for you to use the DOS `MODE` command to initialize the serial port and redirect printer output as you would if you were not using a print spooler.

For more details on the use of the `MODE` command with serial printers please refer to the appropriate section of your DOS manual.

## 8.5 Using the Print Spooler

Once you have successfully installed the print spooler its operation is automatic. No user intervention is necessary with the exception of the optional active mode commands noted above.

## Section 9 — Clock-Calendar Software

### 9.1 All About Clock-Calendar Software (For use with Paradise products containing clock-calendars.)

If you have a clock-calendar, like the one found on the Modular Graphics Card Clock & Memory Module, your system can remember the date and time regardless of whether your computer is on or off, eliminating the need to type in the date and time each time you turn on your computer.

The balance of this section is devoted to the details of installation and operation of the clock-calendar support software supplied with the Clock & Memory module of the Modular Graphics Card. If you do not own this product you may disregard this section of the manual.

### 9.2 Copying the Clock-Calendar Support Software to Your Working Diskette

All of the features and functions of the Modular Graphics Card clock-calendar software are contained in the file called CLSET.COM. This file is not copy protected and may be copied to a working copy of your DOS diskette (not your original) or any other working or archive diskette you choose.

You may copy CLSET.COM and any of the other supplied files with the COPY command in DOS. The following steps outline how to copy CLSET.COM to another disk. If you are new to PC DOS, please take some time to read the sections in your DOS manual pertaining to the COPY command.

European users: If you wish to use the European date format (DD/MM/YY) you may copy the supplied file CLSET.EUR to your working diskette, then rename it CLSET.COM.

#### Floppy Disk System Users:

- Step 1.** Start your computer system with a working copy of your DOS diskette. This disk should have at least 5KB of unused space and should not have a tab over its write-protect notch.

**Step 2.** Press the **RETURN** key twice to get past the DATE and TIME prompts if necessary. When you have the DOS prompt (A>), insert the Paradise diskette in drive B. (If you have a one drive system, you will be prompted when to insert the supplied diskette in the A drive.)

**Step 3.** Type the following: **COPY B:CLSET.COM RETURN**. This will copy the clock-calendar software to the diskette in drive A. Users of single drive systems will be prompted to "Insert the disk for drive B:" during the copy process. This is the time to insert the Paradise diskette in the drive. By the same token, when you see the prompt "Insert the disk for drive A:" re-insert your DOS or working disk.

### Hard Disk System Users:

**Step 1.** Start your system in DOS as you normally do. You may start either from a floppy diskette or the hard disk.

**Step 2.** Make your hard disk the active (default) drive by typing its name (usually C:) followed by the return or enter key.

**Step 3.** Insert the Paradise diskette in drive A: and type: **COPY A:CLSET.COM RETURN**.

You now have a working copy of CLSET.COM on your working diskette or hard disk. Place the Paradise diskette in a safe place. You should not use the Paradise diskette for day to day operations.

## 9.3 Setting the Clock-Calendar

When you first install the Clock-Calendar module in your system, you must set the time and date of the Clock-Calendar to reflect the current time and date.

The procedure is as follows:

1. Bring up your system into PC or MS DOS.
2. At the DOS prompt (A> or B> or C>), Type **A: RETURN** (This will insure that the A: drive is active.)
3. Insert the diskette supplied with the Modular Graphics Card or any disk with our CLSET.COM program on it in drive A.
4. Set the system time and date if you have not already done so. (You may invoke a prompt for time and date by typing TIME and DATE at the DOS prompt respectively.)

5. Type: **CLSET CLOCK RETURN**. This will take the time and date information from the system clock and use it to set the Clock-Calendar in the Modular Graphics Card Clock-Calendar Module.

## 9.4 Setting Your Computer's System Clock From the Clock-Calendar

Once you have set the Clock-Calendar in the Modular Graphics Card (see section 9.3 above) you may then use the CLSET.COM program to set your system clock whenever you start your system.

The procedure is as follows:

1. Bring up your system into PC or MS DOS.
2. At the DOS prompt (A> or B> or C>), Type **A: RETURN** (This will insure that the A: drive is active.)
3. Insert the diskette supplied with the Modular Graphics Card or any disk with the supplied program CLSET.COM in drive A:.
4. Type: **CLSET SYSTEM RETURN** This will provide the automated equivalent of manually typing the DATE and TIME each time you start your system.

## 9.5 Making Time and Date Setting Automatic

After installing the Modular Graphics Card in your system you may wish to automate the setting of the date and time whenever you start your system. You may accomplish this by incorporating the phrase: **CLSET SYSTEM** in a batch file called **AUTOEXEC.BAT** on the diskette or on the root directory of the hard disk that you use to start your system.

The scope of this manual does not permit a detailed discussion of batch files and their creation, but let us refer you to your DOS manual for this information. Look in the index of your DOS manual for references to **BATCH** files and the **AUTOEXEC.BAT** file.



## Appendix A — IBM Diagnostics, the Modular Graphics Card & Monochrome Displays

The Modular Graphics Card configured for a monochrome display may be tested with IBM diagnostics provided that you start your system using the diskette supplied from Paradise Systems, Inc.

The procedure is as follows:

- Step 1.** Insert the supplied Paradise Systems diskette in drive A and turn your system on.
- Step 2.** When you are presented with a welcome screen giving you a choice of Diagnostics startup or DOS startup, insert your Diagnostics diskette in drive A and type a 2. In a moment, you will be presented with the opening diagnostic menu.
- Step 3.** At the conclusion of your diagnostic session, powerdown the computer and restart as you normally do.

If you execute Diagnostics without starting your system with the Paradise diskette Diagnostics can return a 501 error when using a monochrome display.

If you are using a composite or RGB monitor no special preparation is necessary in order to run Diagnostics.

## Appendix B — Technical Specifications for the Modular Graphics Card

<b>Bus:</b>	<b>IBM Standard</b>
<b>Slot Usage:</b>	1 regardless of installed options
<b>Addressing:</b>	Card appears as an IBM color/graphics board, 16K of video memory redundantly mapped through a 32K block of address space starting at B8000.
<b>Outputs:</b>	Video board only: 9 pin connector serving IBM monochrome or equivalent displays, composite displays or RGB displays. 4 pin berg strip serves RF modulator. 60 pin MGC BUS connector provides bus access for Paradise-A, B and C Modules.
<b>Inputs:</b>	6 pin berg strip serves light pen input.
<b>Power requirements:</b>	Approximately 4 watts exclusive of option modules.
<b>Bus Loading:</b>	Less than 1 TTL load per bus line.

Resolution, color and monitor support:

Monitor:	IBM Monochrome	RGB	B&W Composite	Color Composite
40x25 Text (B&W)	YES	YES	YES	YES
80x25 Text (B&W)	YES	YES	YES	YES
40x25 Text (16 colors)	YES(1)	YES	YES(1)	YES
80x25 Text (16 colors)	YES(1)	YES	YES(1)	YES
Medium Res. Graphics 320x200 by 2 palettes of 4 colors.	YES(1)	YES	YES(1)	YES
High Res. Graphics 640x200 B&W	YES	YES	YES	YES

1. On black and white composite and IBM monochrome (or equivalent monitors) all color information is automatically converted to true gray scale for utmost clarity.

Options: Three types of option modules are available, A modules, B modules and C modules. Each card can support one A module or one A & one B module, or one C module.

Current choices include:

- A Modules: Serial port (RS-232). Parallel printer port.
- B Module: 256K memory & clock.
- C Module: 384K memory, clock, serial, parallel on one full length module.

Check With Your Dealer for Complete Module Availability

Screen resolution by monitor & mode:

Mode	Monochrome Monitor	RGB or Composite
Text Graphics	640x350 (8x14) (1)	640x200 (8x8) (2)
	320x400 (3)	320x200
	640x400 (3)	640x200

1 and 2. Figures in parenthesis refer to size of text mode character matrix. Contrast with IBM products: The IBM monochrome display adapter provides a 9x14 matrix for monochrome displays and the IBM color/graphics display adapter provides an 8x8 character matrix for composite & RGB monitors.

3. On monochrome displays, 400 lines of raster are generated and each of 200 lines of information are doubled to achieve a full screen. Yield is 200 dots addressable from top to bottom of screen. (Same as IBM color/graphics adapter.)

## Appendix C — Warranty and Service Information

### Paradise Systems Limited Warranty

Paradise Systems, Inc. warrants this Paradise Systems product to be in good working order and free from defects in materials and workmanship for a period of one year from the date of delivery to the customer. Paradise Systems liability shall be limited to replacing or repairing, at its option, any defective product which is returned freight prepaid to Paradise's plant at 217 East Grand Avenue, South San Francisco, California 94080, but in no case is any product to be returned to Paradise Systems, Inc. without first obtaining written permission of Paradise Systems, Inc. Paradise Systems, Inc. shall not be responsible for shipping charges, nor for any loss or damage to the product occurring during the return. Products which have been subject to abuse, misuse, alteration, neglect or unauthorized repair or installation are not covered by this warranty. Paradise Systems, Inc. shall make the final determination as to the existence and cause of any alleged defect. No warranty is made with respect to custom products produced to the customer's specifications except as specifically stated in writing by Paradise Systems, Inc.

THIS WARRANTY IS IN LIEU OF ANY OTHER WARRANTY EXPRESS OR IMPLIED. PARADISE SYSTEMS, INC. MAKES NO OTHER WARRANTIES, EXPRESS OR IMPLIED, INCLUDING ANY WARRANTY OF FITNESS FOR A PARTICULAR PURPOSE OR OF MERCHANTABILITY. IN NO EVENT SHALL PARADISE SYSTEMS, INC. BE LIABLE FOR INDIRECT, SPECIAL OR CONSEQUENTIAL DAMAGES SUCH AS LOSS OF PROFITS OR BUSINESS OPPORTUNITIES.

If this Paradise Systems product ever needs service, check with your dealer first. If he can't help you please call us at (415) 588-6000.

Warranty and non-warranty service is available from Paradise Systems, Inc. However, no product may be returned to us without first obtaining a RETURN AUTHORIZATION NUMBER. This number may be secured by calling Paradise Systems at: (415) 588-6000. No unauthorized shipments will be accepted.

## Appendix D — Installation Considerations for Amdek 310A and Quadram Quadchrome Monitors

Both the AMDEK 310 series and the Quadram Amberchrome monitors contain circuitry that will, under some circumstances, shut off the picture when the Modular Graphics Card monochrome support software starts.

If this happens, you can get the picture back by turning off the monitor for a few moments then turning it back on. AMDEK supports a modification to their monitor that will eliminate this problem completely without voiding the monitors warranty.

Locate resister R-203 on the motherboard inside the monitor. Disconnect or cut one leg of the resistor from the motherboard. When viewed from the rear of the monitor, R-203 is at the front, right hand corner of the motherboard.

This modification will also work on the Quadram Amberchrome monitor. Quadram supports this modification as long as it is performed by a qualified technician.

**WARNING: THIS MODIFICATION INVOLVES OPENING YOUR MONITOR. MONITORS CONTAIN HIGH VACUUM PICTURE TUBES WHICH ARE VERY FRAGILE. HIGH VOLTAGES ALSO MAY BE PRESENT EVEN AFTER THE UNIT IS TURNED OFF. DO NOT ATTEMPT THIS MODIFICATION YOURSELF. IT SHOULD BE PERFORMED BY A QUALIFIED TECHNICIAN.**

## Appendix E — Modular Graphics Card Connector Pin-Outs

### Modular Graphics Card Video Connector Pinout with Monitor Select Jumper in "Mono" Position

Pin #	Function
1	Ground
2	Ground
3	Red
4	Green
5	Blue
6	Intensity (+)
7	Video (+)
8	Horizontal Sync (+)
9	Vertical Sync (-)

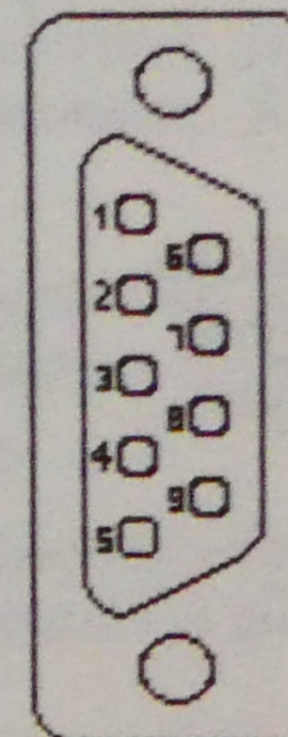

### Modular Graphics Card Video Connector Pinout with Monitor Select Jumper in "RGB" Position

Pin #	Function
1	Ground
2	Ground
3	Red
4	Green
5	Blue
6	Intensity
7	Not Used
8	Horizontal Sync
9	Vertical Sync

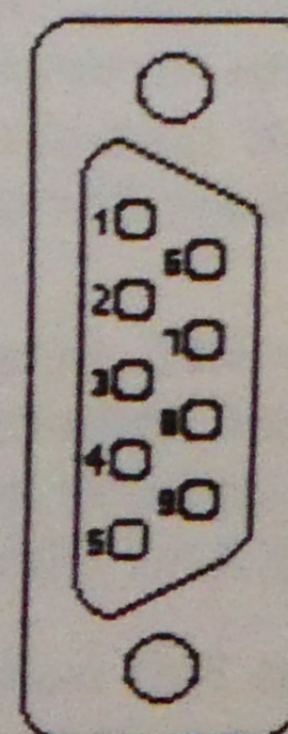

### Modular Graphics Card P3 (Light Pen) and P4 (RF Modulator) Pinouts

■	1 Light Pen Input
□	2 (Key) Unused
■	3 Light Pen Switch
■	4 Chasis Ground
■	5 +5 Volts
■	6 +12 Volts

P3

■	1 +12 Volts
□	2 (Key) Not Used
■	3 Composite Video
■	4 Logic Ground

P4

## Modular Graphics Card Video Connector Pinout with Monitor Select Jumper in "Comp" Position

Pin #	Function
1	Ground
2	Ground
3	Red
4	Green
5	Blue
6	Intensity
7	Composite Video
8	Composite Sync
9	Video w/o Sync

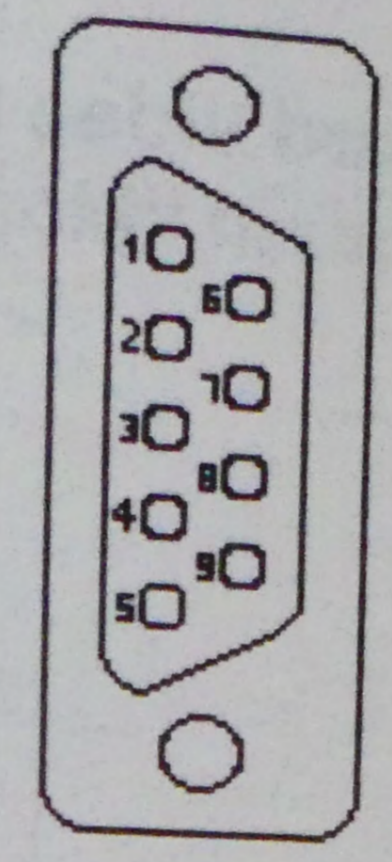

## Appendix F — Using the Modular Graphics Card in a Two Monitor System

The Modular Graphics Card may be used as a replacement for a standard color/graphics card in a two monitor system by following these steps:

1. Set the Monitor Select Jumper to either the "RGB" or "COMP" position as appropriate for your monitor. (Refer to SECTION 2 of this manual for details.)
2. Set the computer system's configuration switches for operation with a monochrome display adapter. (See your computer system's documentation for details.)
3. Install a standard monochrome display adapter and the Modular Graphics Card into available expansion slots in your computer system.
4. Connect an RGB color or a composite monitor to the Modular Graphics Card and a monochrome display to the monochrome display adapter.
5. Double check your work. Both the monochrome display adapter and the Modular Graphics Card have the same kind of connector. Be sure you have connected the correct monitor to the correct card. Otherwise, monitor damage will result.

Now you may turn on your computer. The monochrome display will be the default display. You may switch between monitors using the DOS MODE command for most versions of PC and MS DOS. (See your DOS manual for details of the MODE command.)

If you are using a software application that can take advantage of two monitors this is the appropriate configuration.

IBM PC and compatible computers do not automatically take advantage of two monitor installations. It is up to the application software package to perform this function.

## Appendix G — Finding the Right S1 Switch Settings for Your Monochrome Display

Levers 1 through 5 of S1 on the Modular Graphics Card are used to adjust the card for variations between brands of monochrome monitors. The table below gives generally accurate settings for the monochrome displays we have tested.

Brand of Monochrome Display	Lever 1	Lever 2	Lever 3	Lever 4	Lever 5
IBM	OFF	OFF	OFF	OFF	OFF
Princeton MAX-12	ON	OFF	ON	OFF	OFF
Roland MB-122 Series	OFF	ON	OFF	ON	OFF
Roland MB-142	OFF	OFF	ON	ON	OFF
Leading Edge	ON	OFF	OFF	ON	ON
Grandwood					
Monochrome	OFF	OFF	OFF	OFF	OFF
AMDEK 310A	OFF	OFF	ON	ON	OFF
ITT Monochrome	OFF	ON	ON	ON	ON

**Table G1**

Switch S1, Levers 1 Through 5 Select Monochrome Display Parameters

If your brand of monochrome display is not listed above, or if you are experiencing trouble with rolling screens in graphics mode or diagonal lines at the top of your screen (in one or more modes), this section will help you find the proper setting for your installation.

A program called MONITOR.COM is provided with your Modular Graphics Card. This program will provide you with a series of test screens. By following the instructions at each screen you will be able to find a switch setting suitable for your installation.

Execute MONITOR.COM by inserting the supplied disk in drive A and at the DOS prompt, type: `A:MONITOR`

The first screen is a page of instructions. Read these carefully. The program will wait for you to hit the  key and then present up to 3 more screens depending on your responses.



The second screen presents some text surrounded by 3 rectangles. At this screen you are directed to check the horizontal centering of the picture. If the picture is readable and none of the rectangles are off the screen, either to the right or the left, hit the **RETURN** key.

If the picture is off the screen, either to the right or the left, adjust the horizontal centering and/or the horizontal hold control(s) on your monitor. If your monitor does not possess either of these controls press the **H** key and then the **RETURN** key.

The third screen presents the same pattern this time prompting you to check vertical stability. If the picture is rolling adjust the vertical hold control (if present on your monitor). If your monitor rolls at this point and does not possess a vertical hold control press the **A** key. You will be presented with a set of S1 switch lever settings appropriate for your installation.

If you see no rolling problem at this screen simply hit the **RETURN** key.

The fourth and last screen prompts you to check vertical centering. If any of the rectangles is off the screen (top or bottom) try adjusting the vertical hold control on your monitor (if available). If you don't have a vertical hold control use the up and down arrow keys on the keyboard to adjust vertical centering. When the picture is centered press the **RETURN** key. You will be presented with switch settings for levers 1 through 5 of S1 on the Modular Graphics Card.

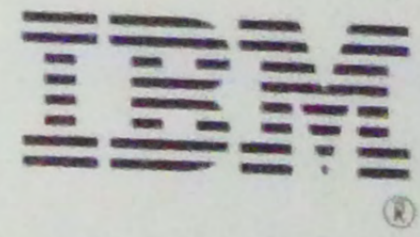

© 1985

**PARADISE**  
SYSTEMS, INC

Modular Graphics Utilities Version:

4.0

1. Insert this disk in Drive A
2. Turn on computer
3. Follow prompts

Copyright © 1985, Paradise Systems, Inc.

**PARADISE**  
SYSTEMS, INC

IBM

70-000001

Dear Paradise Systems Customer:

Thank you for purchasing this Paradise Systems product. We are proud of the care that went into its design and manufacture. We are sure that it will afford you many years of use.

So that we can better serve you in the future, and to assist us in quickly processing your warranty claim (should one be necessary), please take the time to fill out and return the attached, postage paid reply card.

Your comments and suggestions are welcome. Please address them to:

**Paradise Systems, Inc.**  
217 East Grand Avenue  
South San Francisco, CA 94080  
Attn: Product Marketing Manager

## LIMITED WARRANTY

Paradise Systems, Inc. warrants this Paradise Systems product to be in good working order and free from defects in materials and workmanship for a period of 1 year from the date of delivery to the customer. Paradise System's Liability shall be limited to replacing or repairing, at its option, any defective product which is returned F.O.B. to an authorized Paradise Systems Computer Products Dealer or to Paradise Systems' plant at 217 East Grand Avenue, South San Francisco 94080, but in no case is any product to be returned to Paradise Systems, Inc. without first obtaining the written permission of Paradise Systems, Inc. Paradise Systems, Inc. shall not be responsible for shipping charges for such a return nor for any loss of damage to the product occurring during the return. Products which have been subject to abuse, misuse, alteration, neglect, unauthorized repair or installation are not covered by the warranty. Paradise Systems, Inc. shall make the final determination as to the existence and cause of any alleged defect. No warranty is made with respect to custom products produced to the customer's specifications except as specifically stated in writing by Paradise Systems, Inc.

THIS WARRANTY IS IN LIEU OF ANY OTHER WARRANTY EXPRESS OR IMPLIED. PARADISE SYSTEMS, INC. MAKES NO OTHER WARRANTIES, EXPRESS OR IMPLIED, INCLUDING ANY WARRANTY OF FITNESS FOR A PARTICULAR PURPOSE OR OF MERCHANTABILITY. IN NO EVENT SHALL PARADISE SYSTEMS, INC. BE LIABLE FOR INDIRECT, SPECIAL OR CONSEQUENTIAL DAMAGES SUCH AS LOSS OF PROFITS OR BUSINESS OPPORTUNITIES.

*—Retain this portion for your records—*