

## Digital Scan Converter/デジタルスキャンコンバーター

**DSC-1024HD**

日本語

English

Deutsch

Français

Español

Italiano

**取扱説明書**

お買い上げいただき、ありがとうございます。



電気製品は安全のための注意事項を守らないと、火災や人身事故になることがあります。

この取扱説明書には、事故を防ぐための重要な注意事項と製品の取り扱い方を示しています。この取扱説明書と別冊の「安全のために」をよくお読みのうえ、製品を安全にお使いください。お読みになったあとは、いつでも見られるところに必ず保管してください。

**Operating Instructions**

Before operating the unit, please read this manual thoroughly and retain it for future reference.

**Bedienungsanleitung**

Lesen Sie diese Anleitung vor Inbetriebnahme des Geräts bitte genau durch, und bewahren Sie sie zum späteren Nachschlagen sorgfältig auf.

**Mode d'emploi**

Avant la mise en service de cet appareil, prière de lire attentivement ce mode d'emploi et de le conserver pour toute référence ultérieure.

**Manual de instrucciones**

Antes de utilizar la unidad, lea este manual detenidamente y consérvelo para futuras referencias.

**Istruzioni per l'uso**

Prima di utilizzare l'apparecchio, leggere attentamente questo manuale e conservarlo per un riferimento futuro.

**Owner's Record**

The model and serial numbers are located on the rear. Record the serial number in the space provided below. Refer to these numbers whenever you call upon your Sony dealer regarding this product.

# WARNING

To prevent fire or shock hazard, do not expose the unit to rain or moisture.

Dangerously high voltages are present inside the unit. Do not open the cabinet. Refer servicing to qualified personnel only.

This equipment has been tested and found to comply with the limits for a Class B digital device, pursuant to Part 15 of the FCC Rules. These limits are designed to provide reasonable protection against harmful interference in a residential installation. This equipment generates, uses, and can radiate radio frequency energy and, if not installed and used in accordance with the instructions, may cause harmful interference to radio communications.

However, there is no guarantee that interference will not occur in a particular installation. If this equipment does cause harmful interference to radio or television reception, which can be determined by turning the equipment off and on, the user is encouraged to try to correct the interference by one or more of the following measures:

- Reorient or relocate the receiving antenna.
- Increase the separation between the equipment and receiver.
- Connect the equipment into an outlet on a circuit different from that to which the receiver is connected.
- Consult the dealer or an experienced radio/TV technician for help.

You are cautioned that any changes or modifications not expressly approved in this manual could void your authority to operate this equipment.

This Class B digital apparatus complies with Canadian ICES-003.

Cet appareil numérique de la class B est conforme à la norme NMB-003 du Canada.

## NOTICE

This notice is applicable for USA/Canada only. If shipped to USA/Canada, install only a UL LISTED/CSA LABELLED power supply cord meeting the following specifications.

### SPECIFICATIONS

Plug Type Nema-Plug 5-15p  
 Cord Type SVT or SJT, minimum 3 x 18 AWG  
 Length Maximum 15 feet  
 Rating Minimum 7A, 125V

Cette notice s'applique aux Etats-Unis et au Canada uniquement.

Si cet appareil est exporté aux Etats-Unis ou au Canada, utiliser le cordon d'alimentation portant la mention UL LISTED/CSA LABELLED et remplissant les conditions suivantes:

### SPECIFICATIONS

Type de fiche Fiche Nema 5-15 broches  
 Cordon Type SVT ou SJT, minimum 3 x 18-AWG  
 Longueur Maximum 15 pieds  
 Tension Minimum 7A, 125V



## Warning on Power Connection

- Use a proper power cord for your local power supply.



115 Volts



230 Volts  
(not provided on standard cord set)

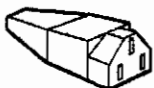

CEE-22 cord set, female end (all power cord sets)

	United States, Canada, Japan	Continental Europe	United Kingdom, Ireland	Australia, New Zealand
Plug type	NEMA 5-15P	CEE 7/VII (Schuko)	BS 1363	SAA AS 3112
Cord type	SJT	HAR (HO5VV-F3G1.0)	HAR (HO5VV-F3G1.0)	CDB03PLP
Minimum cord set rating	7 A/125 V 3 x 18AWG	7 A/250 V	7 A/250 V	7 A/250 V
Cord length	2 m ± 0.1m	2.5 m ± 0.1 m	2.5 m ± 0.1 m	2.5 m ± 0.1 m
Safety approval	UL/CSA	HAR	BSI, ASTA	Dept. of Energy of New South Wales

Autoranging universal power supply works anywhere; the unit self-adjusts if the appropriate power cord and plug for the local voltage are used.

The socket-outlet should be installed near the equipment and be easily accessible.

# Precautions

## On safety

- The nameplate indicating operating voltage, power consumption, etc. is located on the rear.
- Should any solid object or liquid fall into the cabinet, unplug the unit and have it checked by qualified personnel before operating it further.
- Unplug the unit from the wall outlet if it is not to be used for several days or more.
- To disconnect the AC power cord, pull it out by the plug. Never pull the cord itself.

## On installation

- Allow adequate air circulation to prevent internal heat build-up. Do not place the unit on surface (rugs, blankets, etc.) or near materials (curtains, draperies) that may block the ventilation holes.
- Do not install the unit near heat sources such as radiators or air ducts, or in a place subject to direct sunlight, excessive dust or humidity, mechanical vibration or shock.
- If the internal temperature becomes high, the built-in thermal protector automatically functions to turn off the unit.

## On application

This unit converts the scanning frequency and the scanning lines of the video signal. The unit does not recognize or communicate the information superimposed on the blanking signal, such as a copy guard signal or closed caption information.

A part of the information of the input signal may be lost in the conversion process.

## On cleaning

To keep the unit looking brand-new, periodically clean it with a mild detergent solution. Never use strong solvents, such as thinner or benzine, or abrasive cleansers since these will damage the cabinet. As a safety precaution, unplug the unit before cleaning it.

## On repacking

Do not throw away the carton and packing materials. They make an ideal container in which to transport the unit. When shipping the unit to another location, repack it as illustrated on the carton.

If you have any questions about this unit, contact your authorized Sony dealer.

# Table of contents

Features .....	28
Location and function of parts and controls .....	30
Front panel .....	30
Rear panel .....	32
Hookups .....	34
Hookup for getting the up-converted signal .....	34
Hookup for getting the down-converted signal .....	35
Watching the converted picture .....	36
Converting the picture .....	36
Using the line doubler .....	36
Watching a still picture .....	37
Getting rid of on-screen information .....	37
Adjusting the picture .....	38
Zooming and resizing the picture .....	39
Using the memory .....	40
Using the test pattern .....	41
Using the remote commander .....	42
Operating a specific unit with the remote commander .....	43
Using the generator lock (gen-lock) .....	44
Constructing a projection wall .....	45
Selecting the setup level .....	46
Selecting the on-screen language .....	46
Adjusting the SC/H (Subcarrier to Horizontal) .....	46
Using the HDTV output .....	46
Troubleshooting .....	47
Specifications .....	48

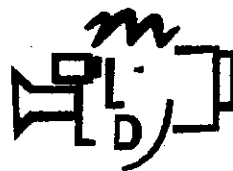

# Features

Thank you for purchasing the Sony Digital Scan Converter. Here are some of the features you'll enjoy with your converter:

## Example of up conversion

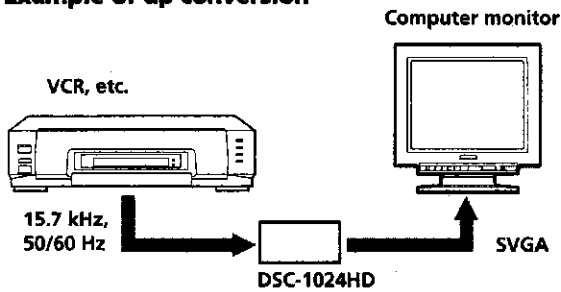

## Example of down conversion

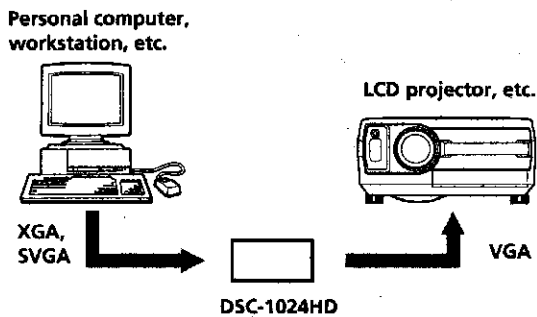

## Example of gen-lock

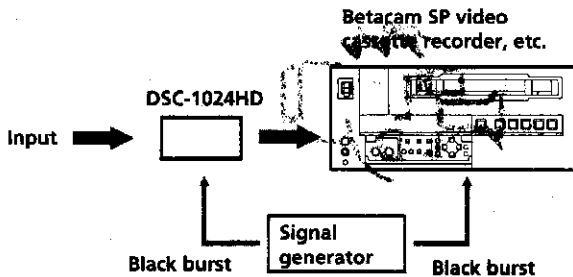

## Combination of Transcoder with Format Converter

The unit is capable of converting the video signal format among composite video, Y/C, component and RGB, and either up or down converting the scanning frequencies in the range of fH: 15 kHz - 70 kHz and fV: 50 - 120 Hz into seven resolution formats, including the HDTV (1920 x 1080) format. With this new combination of the transcoder and format converter functions, the unit accepts variable video input sources to display images with high-resolution monitors or projectors, or to record and play back with ordinary video equipment.

## Line Doubling

The scanning frequencies of the input NTSC or PAL signals can be doubled for each field to 31.5 kHz horizontal frequency by interpolating information on line signals vertically. This enables smooth reproduction of fast moving pictures.

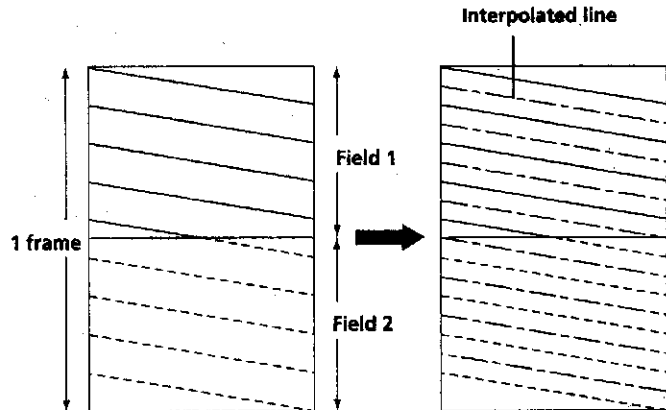

## Generator lock (Gen-lock)

When you use this unit with your video editing system, the output NTSC or PAL signal can be locked to a reference signal (black burst video).

## Aspect ratio display

The aspect ratio of the converted picture is displayed on the screen as you zoom the picture or change the picture size.

## Other features

- Three dimensional comb filter for NTSC Y/C separation
- Line correlation comb filter for PAL Y/C separation
- Up to  $\times 4$  zooming
- Accepts infrared or wired Sony remote commanders using SIRCS code
- On-screen display in five languages for user-friendly access
- Built-in test patterns for display alignment
- Three sets of video inputs with audio inputs: one composite video or Y/C input, one composite video or RGB/component input, and one RGB/component input
- Memory function for storage of up to five operation settings
- Automatic input signal detection with indication
- Self-adjusting for uniform output signal
- EIA rack mounting
- Selectable setup level (black reference level) for the output NTSC signal

## Rack mounting

You can mount the unit on a 19-inch EIA standard rack using the optional MB-510 mounting bracket kit.

- 1 Attach the handle brackets with the four screws included with this unit.**

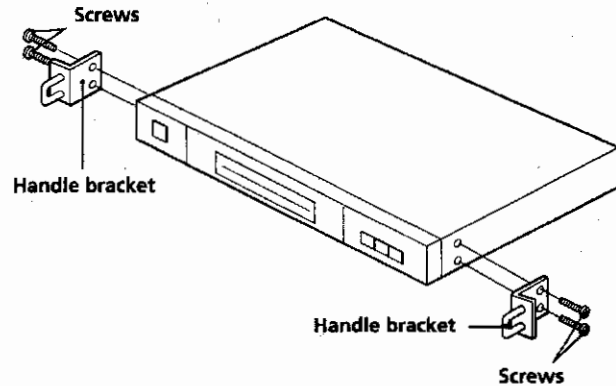

- 2 Remove the four legs from the bottom of the unit.**

- 3 Mount the unit into a 19-inch standard rack.**

### Caution

Do not hold the handle brackets to carry the unit. If you do, the unit may separate from the handle brackets.

# Location and function of parts and controls

## Front panel

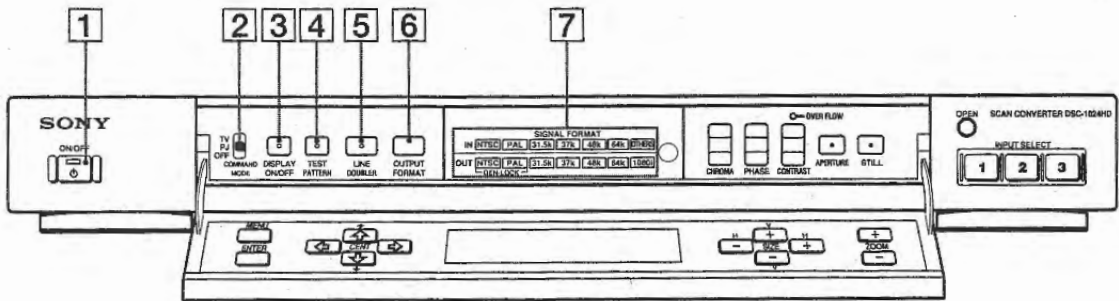

### 1 ON/OFF (power) switch and indicator

Press to turn the unit on and off.  
The indicator on the switch lights when the unit is turned on.

### 2 COMMAND MODE selector

When using the remote commander supplied with the Sony monitor or TV, set it to TV.  
When using the remote commander supplied with the Sony projector, set it to PJ.  
When not using the remote commander, set to OFF.

### 3 DISPLAY ON/OFF button and indicator

Press this button to turn on the indicator (DISPLAY ON) to display the current operating mode on the screen.  
Press it again to turn off the indicator to eliminate the display (DISPLAY OFF).

#### Note

The main menu appears by pressing the MENU button, even if the DISPLAY OFF mode is selected.

### 4 TEST PATTERN button and indicator

Press this button to turn on the indicator to display the test pattern on the screen.  
To turn off the test pattern, press the TEST PATTERN button repeatedly until no test pattern is displayed, or press the ON/OFF, INPUT SELECT or OUTPUT FORMAT button.

### 5 LINE DOUBLER button and indicator

When the input signal format is NTSC or PAL, press this button to turn on the indicator and activate the line doubler function. Press it again to turn off the indicator and cancel the line doubler function.

### 6 OUTPUT FORMAT button

Press this button to select the desired output signal format. The selected output signal indicator lights.

### 7 SIGNAL FORMAT indicators

		SIGNAL FORMAT					
IN	NTSC	PAL	31.5k	37k	48k	64k	OTHERS
OUT	NTSC	PAL	31.5k	37k	48k	64k	1080i
		GEN-LOCK					

#### IN indicators (upper)

Shows the input signal format that the unit automatically detected.  
31.5k, 37k, 48k and 64k indicate the horizontal scanning frequencies. If the horizontal scanning frequency of the input signal detected is one of these values  $\pm 1$  kHz, the corresponding indicator lights. If another value is detected, the OTHERS indicator lights.

#### OUT indicators (lower)

Shows the output signal format selected by the OUTPUT FORMAT button. The output signal format shown by each indicator is as follows:

OUT indicator	Format name
NTSC	NTSC
PAL	PAL
31.5k	VGA 640 × 480
37k	VESA 800 × 600
48k	VESA 1024 × 768
64k	VESA 1280 × 1024
1080i	HDTV 1920 × 1080

For specifications of each format, see "Preset signals" on page 49.

#### GEN-LOCK indicator

When the output signal format is PAL or NTSC and GEN LOCK is set to ON on the menu screen, the GEN-LOCK indicator lights or flashes.

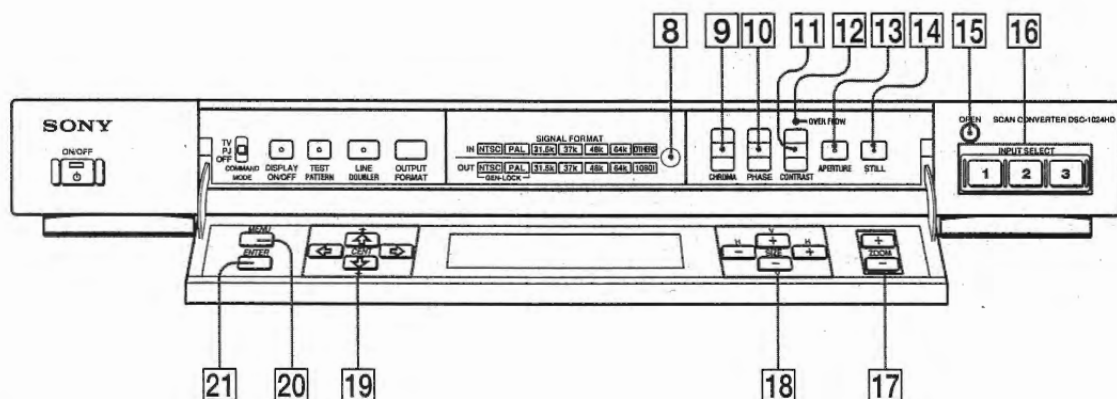

**8 Remote sensor**

Receives the beam from the remote commander.

**9 CHROMA +/- button**

Press to adjust the picture chroma level.

**10 PHASE +/- button**

Press to adjust the picture phase level.

**11 CONTRAST +/- button**

Press to adjust the picture contrast.

**12 OVERFLOW indicator**

This indicator lights when input signal level is excessive.

**13 APERTURE button and indicator**

Press this button to turn on the indicator to make the picture sharper. Press it again to turn off the indicator for a softer picture.

**14 STILL button and indicator**

Press this button to turn on the indicator to get a still picture. Press it again to turn off the indicator to resume the normal screen.

**15 OPEN button**

Press to open the front cover.

**16 INPUT SELECT buttons**

Press to select the input signal.

- 1: to select the input source connected to the VIDEO 1 IN (Y/C or COMP) connector and the AUDIO 1 IN connector.
- 2: to select the input source connected to the VIDEO 2 IN (RGB, YBR\* or COMP) connector and the AUDIO 2 IN connector.
- 3: to select the input source connected to the VIDEO 3 IN (RGB or YBR\*) connector and the AUDIO 3 IN connector.

**17 ZOOM +/- buttons**

Press the + button to zoom up, and the - button to zoom down.

**18 SIZE V/H +/- buttons**

Press to adjust the size of the picture.

- V+: to expand the vertical size
- V-: to reduce the vertical size
- H+: to expand the horizontal size
- H-: to reduce the horizontal size

**19 CENTER/ARROW buttons/cursor buttons**

Press to shift the picture in the direction of the arrow. The  $\uparrow$  and  $\downarrow$  buttons are also used for moving the cursor on the menu screen.

**20 MENU button**

Press to make the menu appear, or quit the menu.

**21 ENTER button**

Press to select the desired item in a menu.

\* YBR is an abbreviation of Y/B-Y/R-Y component signal.

## Rear panel

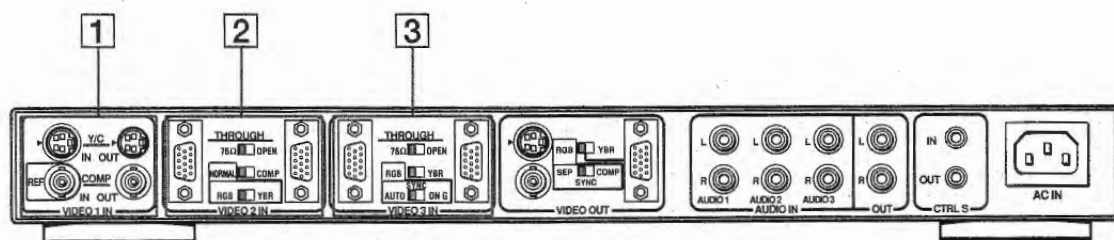

### 1 VIDEO 1 IN connector section

Two sets of video inputs and loop-through outputs.

#### Y/C IN (4-pin):

Connect to the Y/C output of video equipment. This connector has a priority over the COMP IN connector, if both connectors are used.

#### COMP IN/REF (BNC type):

Connect to the composite video output of video equipment.

Also, input the reference signal for the gen-lock (black burst signal) to the VIDEO 1 IN REF connector.

#### Y/C OUT (4-pin):

Loop-through output of the Y/C IN connector.

#### COMP OUT (BNC type):

Loop-through output of the COMP IN connector.

### 2 VIDEO 2 IN connector section

A set of composite video or RGB/component (Y/B-Y/R-Y) signal inputs and loop-through outputs.

#### Composite video/RGB/component input (D-sub 15-pin, 3-row):

Connect one of the D-sub connectors to the composite video, RGB or component (Y/B-Y/R-Y) outputs of video equipment. The other D-sub connector is a loop-through output.

#### Termination switch:

When nothing is connected to the loop-through output connector, set to 75Ω. When the loop-through output connector is used, set to OPEN.

#### NORMAL/COMP (composite) input selector:

Usually set to NORMAL when RGB or component signal is input to the D-sub connector. Set to COMP when composite video signal is input.

#### RGB/YBR\* (RGB/component) input selector:

Set to RGB or YBR according to the format of the signal input to the D-sub connector.

### 3 VIDEO 3 IN connector section

A set of RGB or component (Y/B-Y/R-Y) signal inputs and loop-through outputs.

#### RGB/component input (D-sub 15-pin, 3-row):

Connect one of the D-sub connectors to the RGB or the component (Y/B-Y/R-Y) outputs of video equipment. The other D-sub connector is a loop-through output.

#### Termination switch:

When nothing is connected to the loop-through output connector, set to 75Ω. When the loop-through output connector is used, set to OPEN.

#### RGB/YBR\* selector:

Set to RGB or YBR according to the format of the signal input to the D-sub connector.

#### SYNC selector:

Normally set to AUTO. Set to ON G to use the sync signal on green channel when both external sync signal and sync on green signal are input.

\* YBR is an abbreviation of Y/B-Y/R-Y component signal.



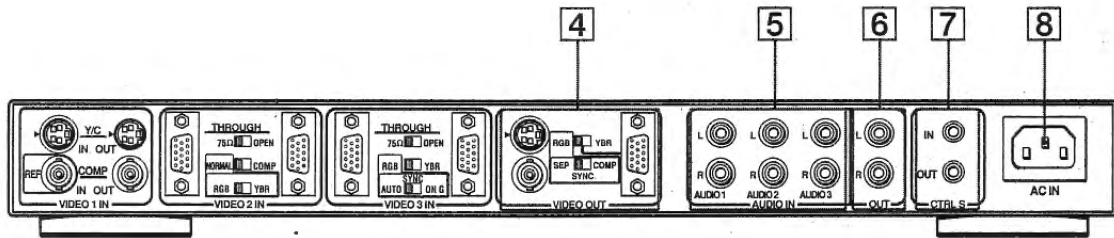

#### 4 VIDEO OUT connector section

Three sets of video outputs. The converted signal is output from this section.

##### Y/C output (4-pin):

Connect to the Y/C input of video equipment. Only the NTSC or PAL signal is output from this connector.

##### Composite video output (BNC type):

Connect to the composite video input of video equipment. Only the NTSC or PAL signal is output from this connector.

##### RGB/component output (D-sub 15-pin, 3-row):

Connect to the RGB or component (Y/B-Y/R-Y) inputs of video equipment.

##### RGB/YBR output selector:

Set this selector depending on the format of the signal output from the D-sub connector. YBR is effective when the NTSC or PAL signal is output.

##### SYNC output selector:

Select the sync signal for the RGB output.  
Set to SEP to use separate horizontal/vertical sync signal.  
Set to COMP to use the composite sync signal.

#### 5 AUDIO IN L/R jacks (RCA pin)

Three sets of audio inputs.  
Connect to the audio output jacks of equipment. If the input source is monaural, connect it to the L jack only. You can select the audio input with the INPUT SELECT buttons on the front panel.

#### 6 AUDIO OUT L/R jacks (RCA pin)

A set of audio outputs.  
Connect to the audio input jacks of equipment.

#### 7 CTRL S IN/OUT jacks (minijack)

Connect to the CONTROL S jacks of other Sony equipment. It is then possible to control the whole system with a single remote commander.  
When a plug is connected to the CTRL S IN jack, the remote sensor on the front panel becomes inactive.

#### 8 AC IN connector

Connect the supplied power cord.

# Hookups

## Before you get started

- First make sure that the power to each piece of equipment is turned off.
- Use connecting cables suitable for the equipment to be connected.
- The cable connectors should be fully inserted into the jacks. A loose connection may cause hum and other noise.
- To disconnect the cable, pull out by grasping the plug. Never pull the cable itself.
- Read the instruction manual of the equipment to be connected.

## Hookup for getting the up-converted signal

The following diagram shows a connection example to convert a low-rate input signal into a high-rate output signal.

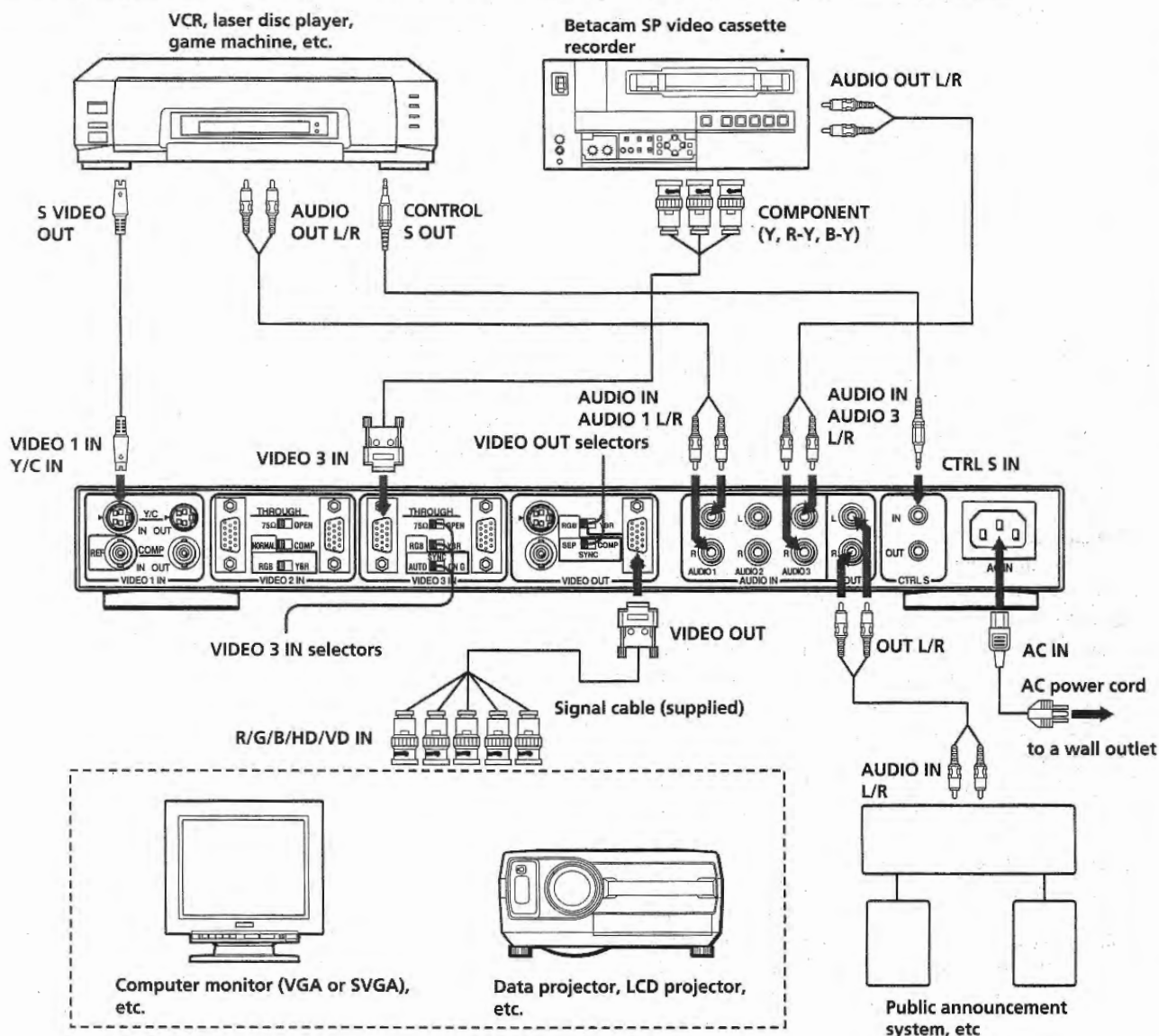

### Setting the VIDEO OUT selectors

- Set the RGB/YBR selector to RGB (when a computer monitor, data projector or LCD projector is connected).
- Set the SYNC selector to SEP (HD or VD separate sync) or COMP (composite sync) depending on the connected equipment.

### When the Betacam SP video cassette recorder is connected to VIDEO 3 IN

Set the VIDEO 3 IN selectors as follows:

- 75 Ω / OPEN selector → 75 Ω
- RGB/YBR selector → YBR
- SYNC selector → AUTO

Connect only the three plugs of the signal cable to the Betacam SP video cassette recorder: green plug to Y connector, red to R-Y, and blue to B-Y. Leave the other plugs, if provided, disconnected.

## Hookup for getting the down-converted signal

The following diagram shows a connection example to convert a high-rate input signal into a low-rate output signal.

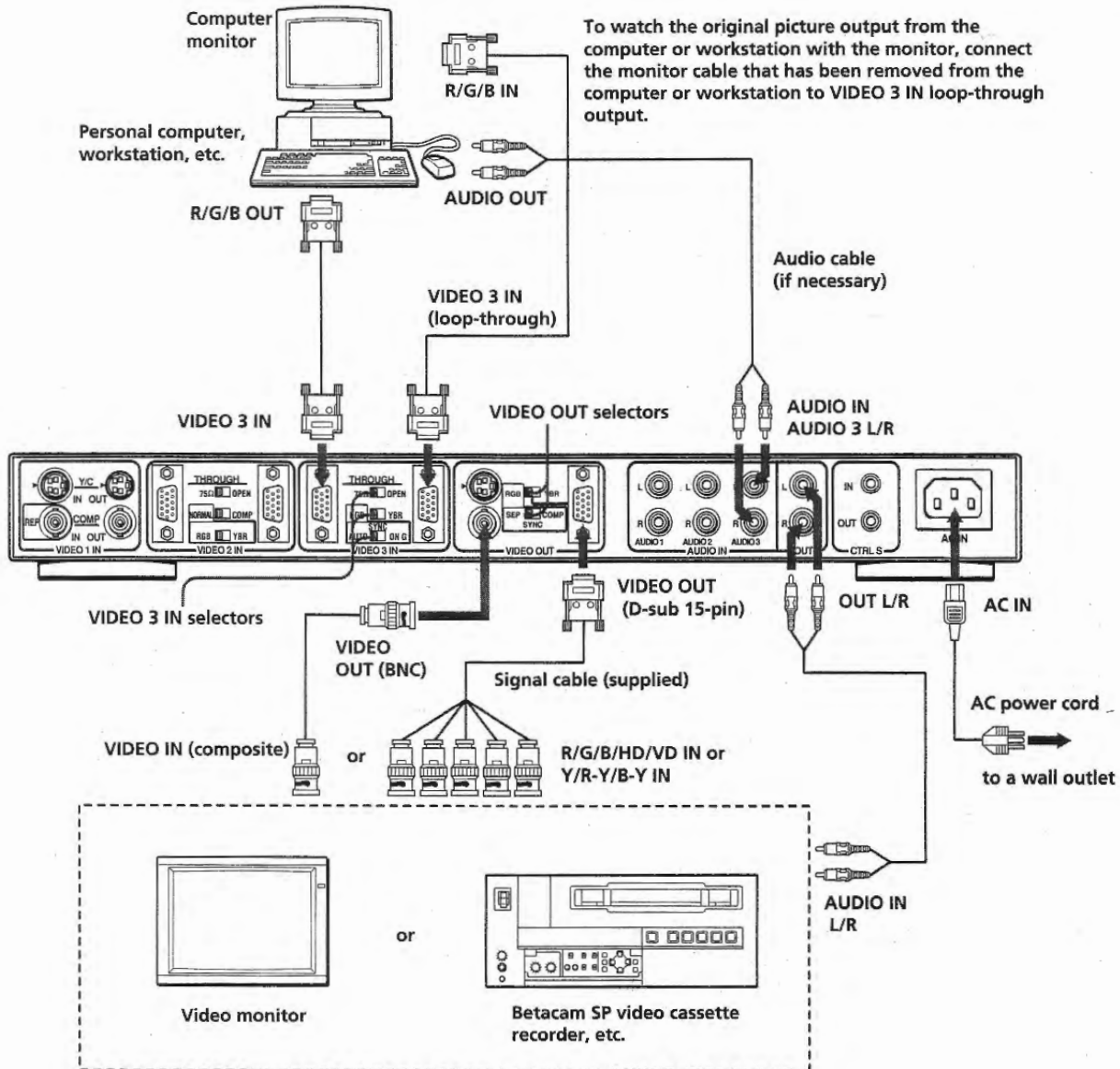

### Setting the VIDEO OUT selectors

- Set the RGB/YBR selector to RGB when a video monitor or video projector is connected. Set it to YBR when a Betacam SP video cassette recorder is connected.
- Set the SYNC selector to SEP (HD or VD separate sync) or COMP (composite sync) depending on the connected equipment.

### When the computer monitor is connected to the VIDEO 3 IN loop-through output

Set the VIDEO 3 IN selectors as follows:

- 75  $\Omega$ /OPEN selector  $\rightarrow$  OPEN
- RGB/YBR selector  $\rightarrow$  RGB
- SYNC selector  $\rightarrow$  AUTO or ON G depending on the connecting equipment

For Macintosh and Silicon Graphics Inc. computers, set to ON G.

# Watching the converted picture

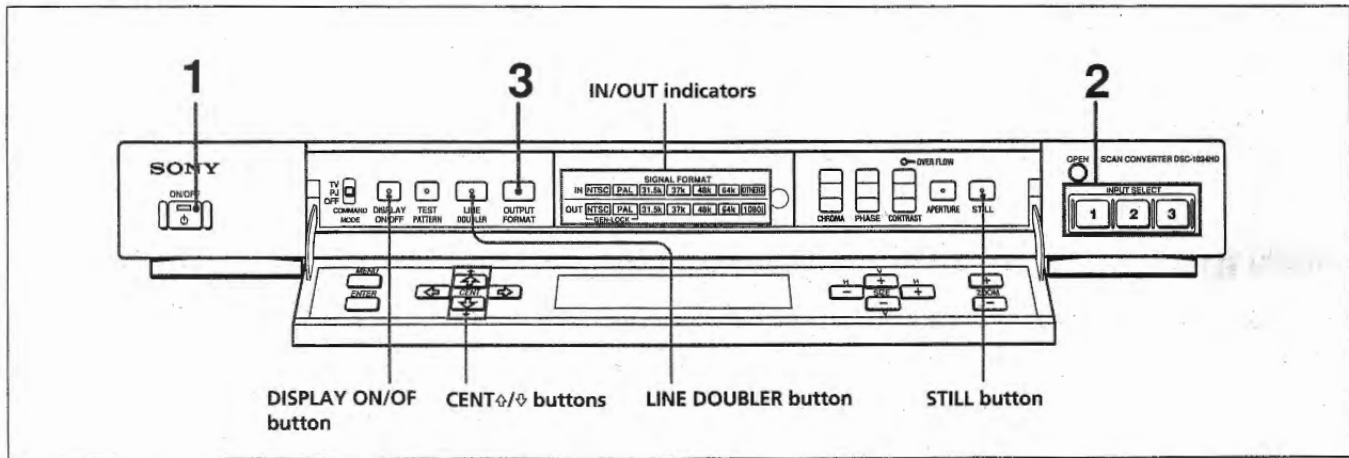

## Before you start

- Turn on the connected equipment and play a video source.
- To display the information on the current operation on the screen, make sure the indicator of the DISPLAY ON/OFF button is lit. If not, press the DISPLAY ON/OFF button.
- To set the on-screen language to yours, see page 46.

## Converting the picture

- 1 Press the ON/OFF switch.**  
The indicator of the ON/OFF switch and all the three INPUT SELECT buttons light.



- 2 Select the input source to be converted by pressing the INPUT SELECT button.**  
The pressed button lights brighter than the others, and the input signal indicator lights to show the input signal format (see page 49).

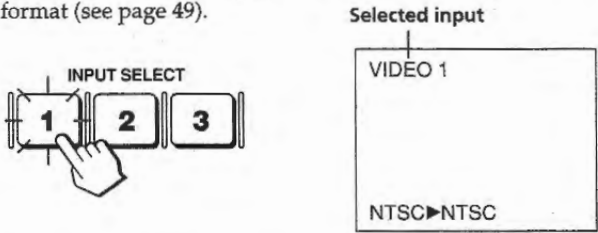

- 3 Select the desired output signal format by pressing the OUTPUT FORMAT button repeatedly.**  
The selected output signal indicator lights. The output signal is switched a few seconds after you release the button.  
For the specification of each output format, see page 49.

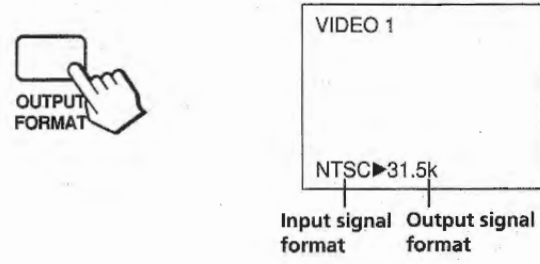

## Using the line doubler

The line doubler function of this unit converts the input NTSC or PAL signal into a digitally interpolated, high scan-rate output signal. The output signal format becomes a non-interlaced signal whose horizontal frequency is 31.5 kHz and vertical frequency is synchronized to the input signal. The line doubler up-converts the signal field by field by interpolating information on two line signals vertically. Therefore, a fast moving picture is reproduced as a natural high-resolution picture.

- The converted signal is output from the RGB/component output connector in the RGB format.
- The line doubler can be activated for the three inputs separately.

## Activating the line doubler

- 1 Press the OUTPUT FORMAT button to select 31.5k.**
- 2 Connect a NTSC or PAL signal source and select the input with the INPUT SELECT buttons.**
- 3 Press the LINE DOUBLER button.**  
The indicator of the button lights, and the NTSC and 31.5k or the PAL and 31.5k OUT indicators light.

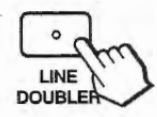

When the input source is NTSC

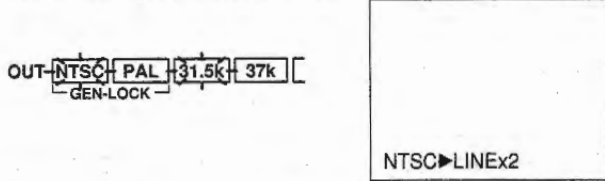

When the input source is PAL

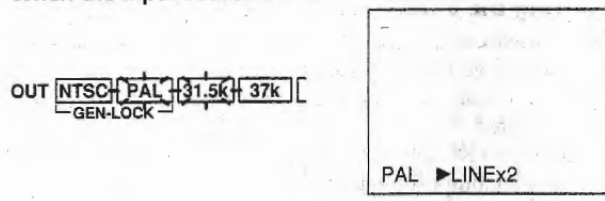

4 A  
To d  
Press  
indica  
**Not**  
• If y  
sou  
"N  
DO  
• Wh  
API  
• Wh  
sam  
• Wh  
inp  
base  
with  
mul  
dist



- 4 Adjust the position of the picture by pressing the CENT  $\uparrow/\downarrow/\leftarrow/\rightarrow$  buttons.

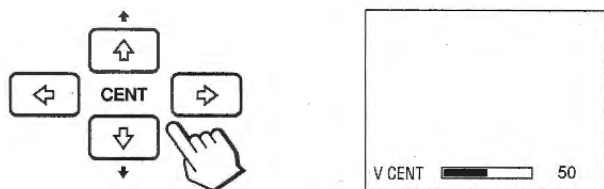

#### To deactivate the line doubler

Press the LINE DOUBLER button again to turn off the indicator of the button. The 31.5k output format is restored.

#### Notes

- If you press the LINE DOUBLER button when the input source is not NTSC or PAL or the output format is not 31.5k, "NOT APPLICABLE" appears on the screen and the LINE DOUBLER button does not function.
- When the line doubler is activated, the ZOOM, SIZE, APERTURE and TEST PATTERN buttons do not function.
- When the line doubler is activated, the picture size is the same as the original one.
- When you use the line doubler function, we recommend the input source video equipment equipped with the TBC (time base corrector). If you activate the line doubler for the signal without the TBC and display the converted signal with a multi-scan monitor, the picture may disappear due to disturbance of the sync signal.

#### Watching a still picture

When a moving picture is displayed, press the STILL button to set STILL on the screen to ON. The output signal is displayed as a still picture. The indicator of the STILL button lights.

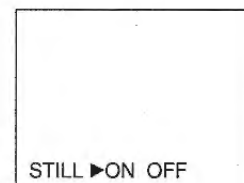

To resume the normal screen, press the STILL button again.

#### Note

In the still picture mode, only the ON/OFF switch, and the INPUT SELECT, OUTPUT FORMAT, MENU, ENTER and CENT  $\uparrow/\downarrow/\leftarrow/\rightarrow$  buttons will function. If you press any other button, "NOT APPLICABLE" appears on the screen.

#### Getting rid of on-screen information

When the indicator of the DISPLAY ON/OFF button is lit, the information on the operation you performed is displayed on the screen for a few seconds.

To get rid of the on-screen display, press the DISPLAY ON/OFF button to set DISPLAY on the screen to OFF.

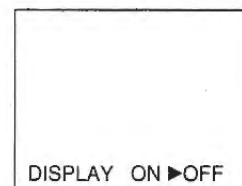

#### Note

Even if DISPLAY is set to OFF, only the main menu appears when you press the MENU button.

# Adjusting the picture

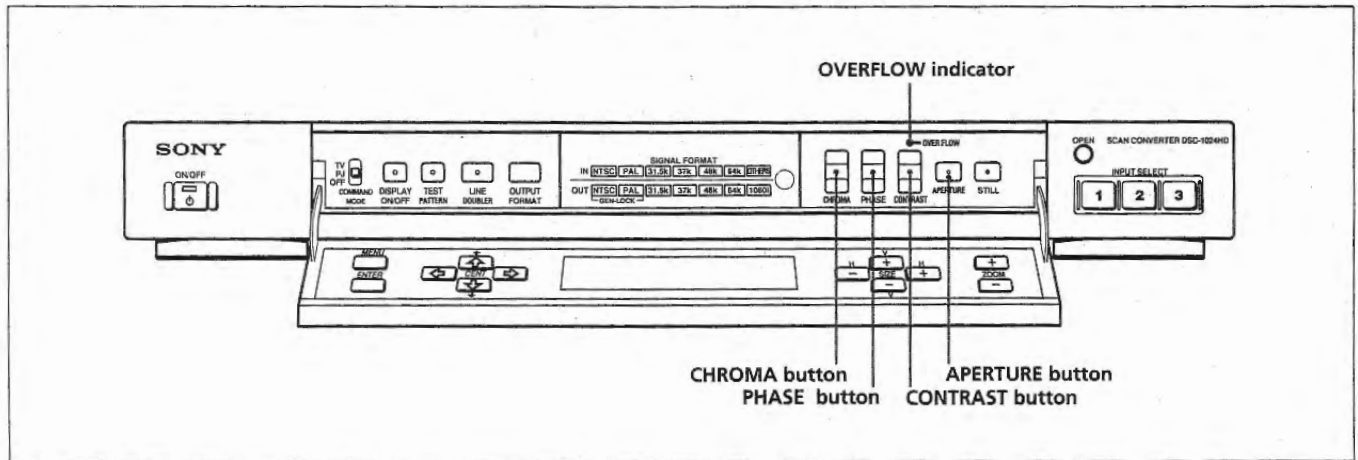

While watching the picture, you can adjust contrast, phase, chroma and aperture to suit your taste. The adjustments can be carried out for the three inputs separately. The adjusted levels are stored in memory.

## Adjusting the contrast, phase, and chroma

Press the desired adjustment button: **CONTRAST**, **PHASE**, or **CHROMA**.

The adjustment levels are displayed on the screen.

### CONTRAST

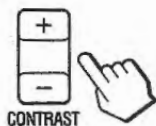

+: to increase picture contrast  
-: to decrease picture contrast

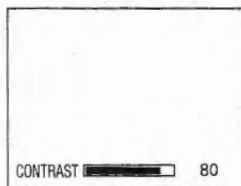

### PHASE

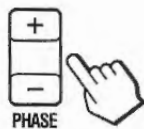

+: to make overall picture greenish  
-: to make overall picture purplish

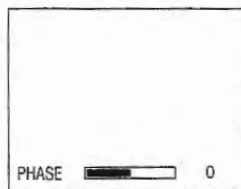

### CHROMA

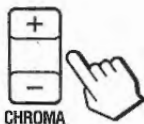

+: to increase color intensity  
-: to decrease color intensity

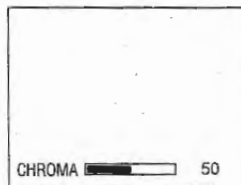

## Adjusting the aperture

To make the picture sharper, press the **APERTURE** button to set **APERTURE** on the screen to **ON**. The indicator of the **APERTURE** button lights.

To make the picture softer, press the **APERTURE** button again to set **APERTURE** to **OFF**.

The factory setting is **APERTURE OFF** for the **NTSC** or **PAL** video input, or **APERTURE ON** for the other inputs.

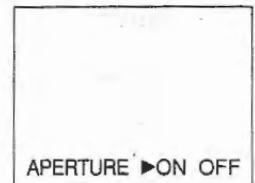

### Note

When the output signal format is an interlaced signal such as **NTSC** and **PAL**, setting **APERTURE OFF** reduces line flickers although the image contour becomes slightly blurred.

### If the input signal level is excessive

The **OVERFLOW** indicator lights. In this case, check that the  $75\ \Omega$  / **OPEN** selector and the **RGB** / **YBR** selector in the **VIDEO 3** connector section are set correctly. If they are correct, press the **CONTRAST -** button.

### Restoring the factory preset contrast, phase and chroma levels

Use **COLOR RESET** on the **MENU 1** screen. (See page 41.)

### Notes

- **CHROMA** and **PHASE** controls do not function for the **RGB** input signal.
  - **PHASE** control does not function for the component (**Y/B-Y/R-Y**) input signal.
  - **PHASE** control does not function with **PAL** color source.
- If you press these buttons, "NOT APPLICABLE" appears on the screen.

# Zooming and resizing the picture

English

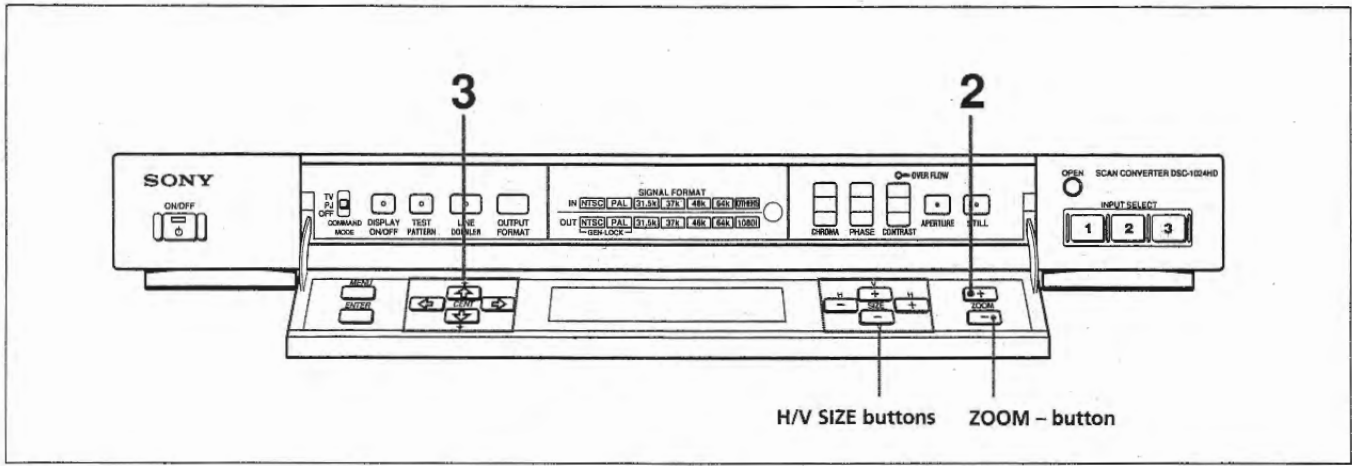

H/V SIZE buttons      ZOOM - button

You can zoom up the picture making it 2, 3 or 4 times larger than the original size.  
 You can also shift the position of the picture so that it fits in the screen, or adjust the vertical and horizontal size of the picture separately.  
 The adjustments can be carried out for the three inputs separately.

### Zooming up the picture

- 1 Display the picture on the screen.
- 2 Press the ZOOM + button.

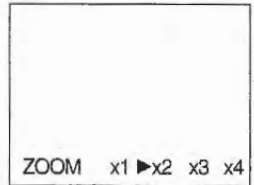

Each time you press the ZOOM + button, the picture is magnified by 2, 3 and 4 times respectively.  
 To zoom down, press the ZOOM - button.

- 3 Adjust the position of the close-up picture by pressing the CENT  $\updownarrow$ / $\leftarrow\rightarrow$  buttons.

- $\updownarrow$ : to shift the picture upward/downward (V CENT)
- $\leftarrow\rightarrow$ : to shift the picture to the right/left (H CENT)

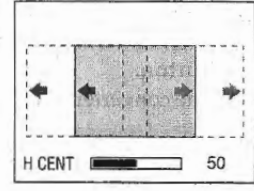
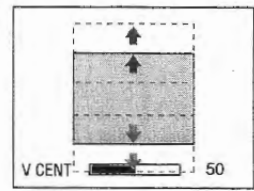
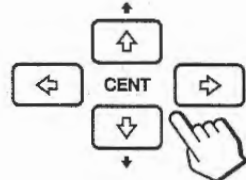

The position of the picture is indicated on the screen by the adjustment bar and value 0 to 100. The factory preset value is 50.

### Resizing the picture

Press the H/V SIZE +/- buttons to resize the picture.

- V SIZE +: to expand vertical size
- V SIZE -: to reduce vertical size
- H SIZE +: to expand horizontal size
- H SIZE -: to reduce horizontal size

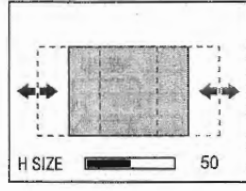
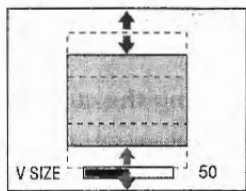
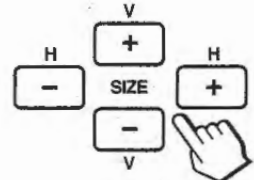

The size of the picture is indicated on the screen by the adjustment bar and value 0 to 100. The factory preset value is 50 (except the HDTV or 64 k input).

### Aspect ratio display

As the picture size changes by the H/V SIZE button, the unit calculates the aspect ratio of the converted picture and displays it in decimal values on the screen together with the adjustment bar and value.

- Example: 4 : 3 is displayed 1.33 : 1
- 16 : 9 is displayed 1.78 : 1

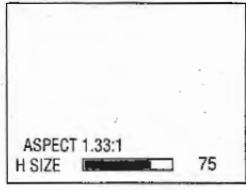

### Note

The aspect ratio is displayed only when a preset signal is input. If an HDTV signal is input, the aspect ratio is displayed based on the Japanese HDTV standard (1920x1035). For the preset signals, see page 49.

### Restoring the original picture size and position

Use GEOM RESET on the MENU 1 screen. (See page 41.)

# Using the remote commander

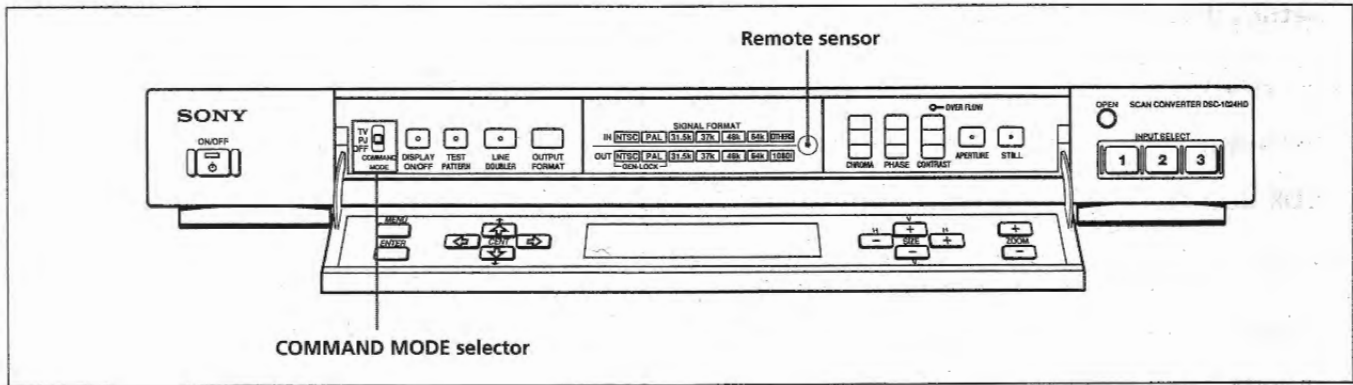

This unit accepts wireless or wired remote commanders for Sony monitors, TVs and projectors.

## Setting the type of the remote commander

Set the **COMMAND MODE** selector according to the type of the remote commander.

TV: Sony monitors' or TVs' commander

PJ: Sony projectors' commander

OFF: When not using the remote commander, set to this position to avoid malfunction.



## Available remote commander operations

The following operations can be controlled by the remote commander.

- Power on/off
- Input selection
- Picture adjustments: contrast, phase and chroma
- On-screen display on/off (only for video monitors and TVs)
- Menu operations (See the right column.)
- Direct memory loading (See the right column.)

The available operations and the buttons to be used for each operation are limited depending on each remote commander. See the table below.

## Direct memory loading

The remote commander can quickly call up the adjustment data stored in the memory.

- 1 Press buttons 7, 7, 7 and ENTER on the remote commander in sequence at intervals of one second. The "MEMORY LOAD READY" appears on the screen.
- 2 Select the memory number (1 to 5) you want to call up using the number button. The converter is adjusted to the selected memory data.

## To cancel the operation

Press buttons 0, 0, 0 and ENTER on the remote commander in sequence at intervals of one second. The "MEMORY LOAD EXIT" appears on the screen.

The direct memory load operation is also cancelled by turning off the unit.

## Note

Be sure to press buttons 7, 7, 7 and ENTER, or 0, 0, 0 and ENTER at intervals of about one second.

If more than 3 seconds elapse between two presses, the operation will be cancelled. In this case, start again.

## Menu operation using the remote commander

The menu screens for the remote commander are different from those for the main unit.

When you press the menu button (MENU, PAGE or ←) on the remote commander once or twice, the GEOM MENU or COLOR MENU appears respectively.

Select the item with the ↑/↓ button and press the enter button (ENTER, → or M SEL) on the remote commander. Then adjust the selected item using the ↑/↓ button.

Remote commander model		RM-854	RM-1271	RM-PJ1292	RM-PJ350	RM-PJC520
<b>COMMAND MODE setting</b>		TV	PJ	PJ	PJ	PJ
Input selection	INPUT SELECT 1	LINE1	VIDEO	VIDEO	VIDEO1	1
	INPUT SELECT 2	LINE2	A	A	VIDEO2	2
	INPUT SELECT 3	LINE3	B	B	RGB	3
Menu operation	MENU	MENU	PAGE or ←	PAGE or ←	PAGE or ←	PAGE
	ENTER	ENTER	→	→	→	M SEL
	CENT ↕	↑	↑	↑	↑	↑
	CENT ↕	↓	↓	↓	↓	↓
Picture adjustment	CONTRAST	CONTRAST	CONTR	CONTR	CONTR	CONTR
	CHROMA	CHROMA	COLOR	COLOR	COLOR	-
	PHASE	PHASE	HUE	HUE	HUE	-



# Operating a specific unit with the remote commander

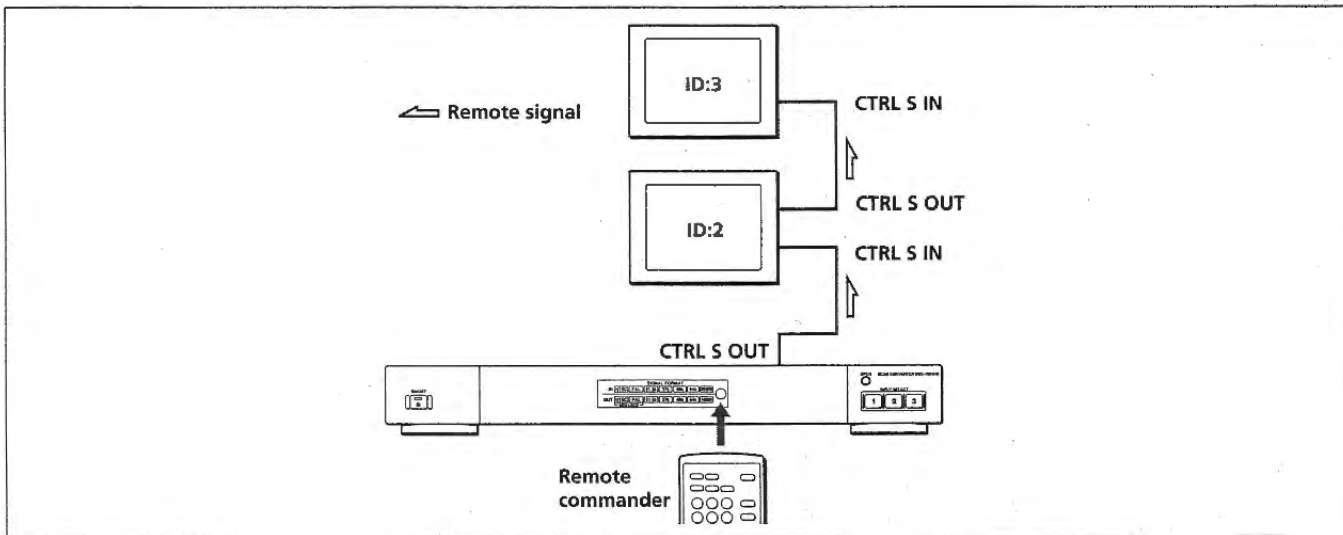

When multiple pieces of Sony equipment are connected via the CTRL S jack, you can operate a specific piece of equipment by assigning the index number preset for each piece of equipment on the converter, and then on the remote commander. For presetting the index number on each piece of equipment, refer to the Instruction Manual of the equipment. The following explanation is an example of use of the RM-854 remote commander.

## Assigning the index number on the converter

- 1 Press the MENU button once.  
The MENU 1 screen appears.

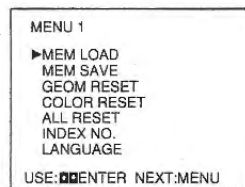
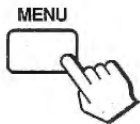

- 2 Press the CENT  $\updownarrow$  button to move the cursor (▶) to INDEX NO. and press the ENTER button.  
The INDEX NO. screen appears.

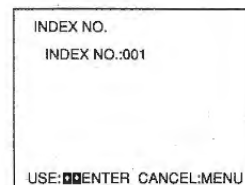
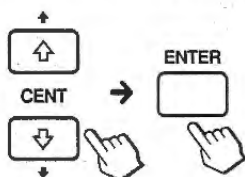

- 3 Press the CENT  $\updownarrow$  button repeatedly to select the index number (1 to 255) of the equipment you want to control, and press the ENTER button.
- 4 To quit the menu, press the MENU button three times.

## Operating the equipment with the RM-854 remote commander

- 1 Press the ID MODE ON button on the remote commander.  
The index numbers appear on all the pieces of equipment including the converter.

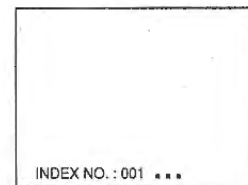
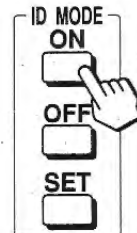

- 2 Input the index number of the equipment you want to operate using 0-9 buttons of the remote commander.  
The input number appears right next to each equipment own index number.

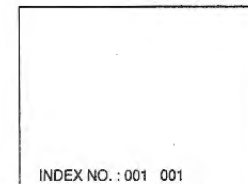

- 3 Press the ID MODE SET button.  
The character on the selected equipment changes to cyan while others change to red.

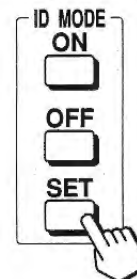

Now you can operate only a specified equipment (All operations available in ID mode except POWER ON/OFF).

# Using the generator lock (gen-lock)

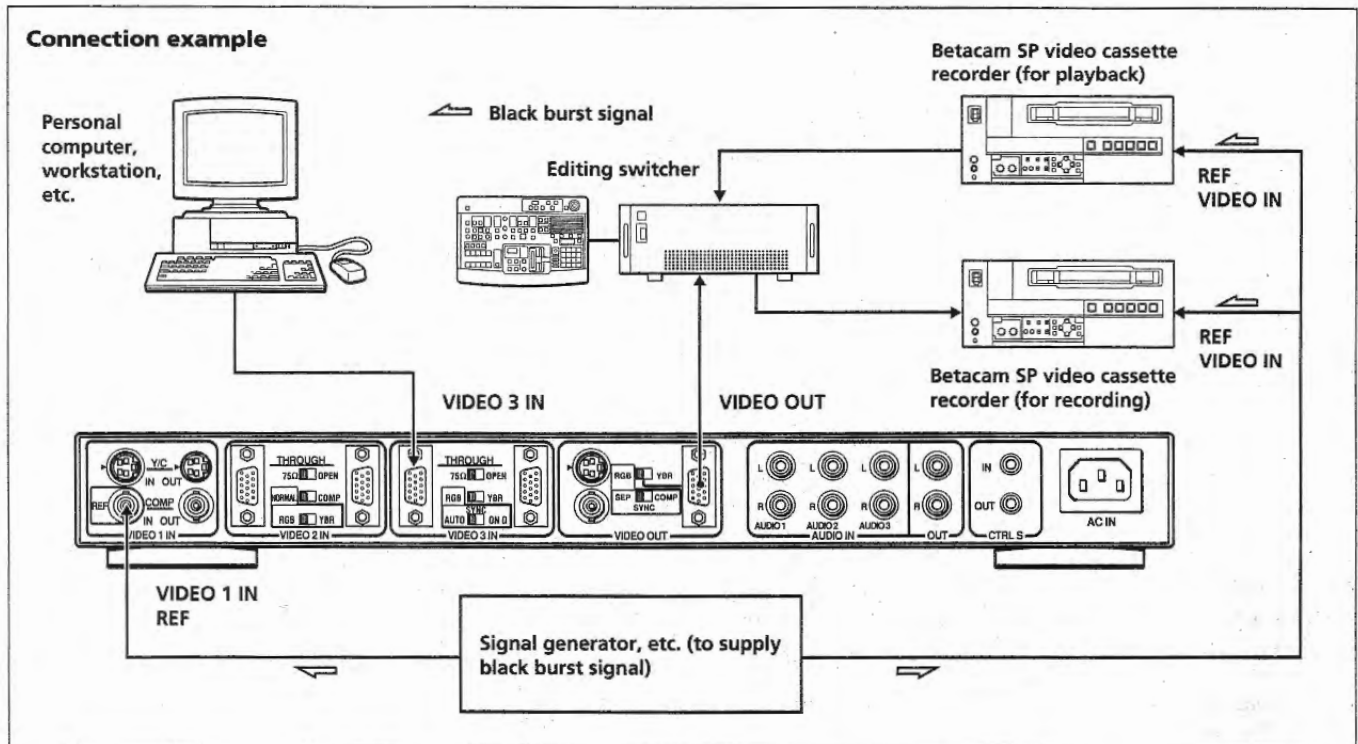

The output NTSC or PAL signal can be synchronized using the black burst signal input from a signal generator, etc. as a reference signal (gen-lock). This enables smooth editing without transition noise when multiple video sources are used.

## Activating the generator lock

- 1 Input the reference signal which corresponds with the output signal format (NTSC or PAL) from the editor or signal generator to the VIDEO 1 IN REF connector.
- 2 Press the MENU button twice. The MENU 2 screen appears.

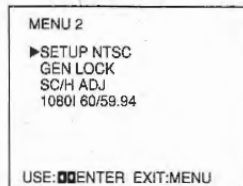
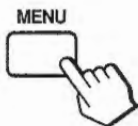

- 3 Press the CENT  $\uparrow/\downarrow$  button to move the cursor (▶) to GEN LOCK, and press the ENTER button. The GEN LOCK screen appears.

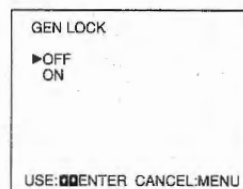
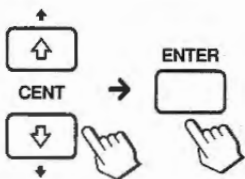

- 4 Press the CENT  $\leftarrow/\rightarrow$  button to move the cursor (▶) to ON, and press the ENTER button.

The gen-lock is activated for the signal output from this unit and the GEN-LOCK indicator on the front panel lights.

When the converter is turned on or the input mode is changed, "GEN LOCK MODE" appears on the screen.

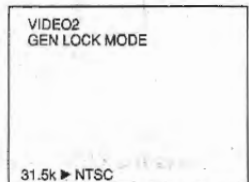

## To deactivate the generator lock

Repeat steps 1 to 3 above, then set GEN LOCK to OFF in step 4. The GEN-LOCK indicator on the front panel turns off.

## Notes

- If you select GEN LOCK on the MENU 2 screen with no reference signal input, "NO REFERENCE" appears on the screen.
- "WRONG REFERENCE" will appear when the reference signal format does not correspond with the input signal format.
- The RGB/component output is recommended for editing. If you use the composite video output, a frame synchronizer may be needed to adjust the phase to the reference signal. For the SC/H (Subcarrier to Horizontal) adjustment, see page 46.

# Constructing a projection wall

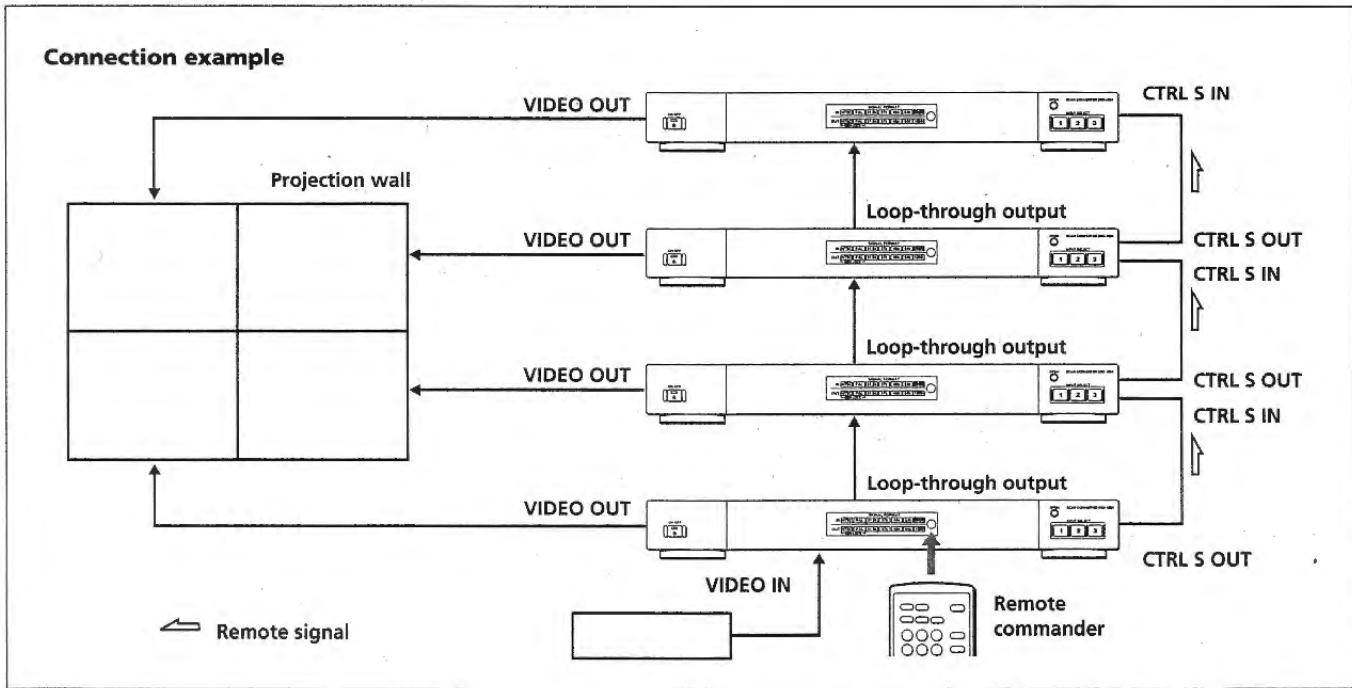

When you construct a projection wall which displays a larger picture constructed from multiple projectors, use the converters as in the connection example above. Prepare one converter for each projector.

Adjust the picture of each projector so that the projection wall picture is displayed smoothly, and store the adjustment data on each converter under the same memory number. This enables you to quickly switch between a total of five projection wall pictures.

## Storing the adjustment data of the picture

### 1 Adjust the projectors.

Use the test patterns (HATCH, COLOR BAR and GRAY SCALE) contained in the converter. For the test patterns, see page 41.

### 2 Adjust pieces of the picture with the converter.

Set the zooming magnification according to the number of pieces of the picture. Then adjust each piece of the picture using the H/V SIZE buttons and CENT buttons so that they connect smoothly as a large picture.

Number of pieces of the picture	Zooming
4	× 2
9	× 3
16	× 4

For zooming and resizing the picture, see page 39.

### 3 Store the adjustment data in the memory of the converter.

Store the data under the same memory number on each converter. For details, see "Storing the current condition" on page 40.

### 4 Repeat steps 1 to 3 for storing other picture patterns.

The adjustment data for up to five picture patterns can be stored under memory numbers 1 to 5.

## Displaying the picture on the projection wall

The names of the remote commander buttons differ depending on the commander model. Refer to the table on page 42.

- 1 Press buttons **7, 7, 7** and **ENTER** on the remote commander in sequence at intervals of one second. "MEMORY LOAD READY" appears on each projector screen.
- 2 Select the memory number under which the adjustment data of the desired picture pattern is stored by pressing the number button. All of the pieces of the picture are displayed properly so that they connect smoothly as a large picture.
- 3 To switch to another picture pattern, press the number button corresponding to the memory number.

# Selecting the setup level

You can select the black level (setup level) for the output NTSC signal.

The black level is set to "0"(IRE) at the factory. If the output picture is too dark, change the setting to "7.5"(IRE).

- 1 Press the MENU button twice.  
The MENU 2 screen appears.

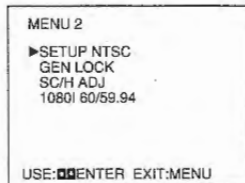

- 2 Press the CENT  $\updownarrow$  button to move the cursor (▶) to SETUP NTSC, and press the ENTER button.  
The SETUP NTSC menu appears.

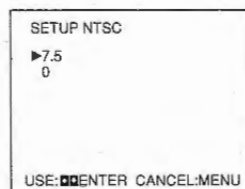
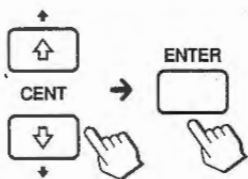

- 3 Press the CENT  $\updownarrow$  button to select "7.5" or "0," and press the ENTER button.
- 4 To quit the menu, press the MENU button twice.

# Selecting the on-screen language

You can select the on-screen language among five languages.

- 1 Press the MENU button once.  
The MENU 1 screen appears.
- 2 Press the CENT  $\updownarrow$  button to move the cursor (▶) to LANGUAGE and press the ENTER button.  
The LANGUAGE menu appears.

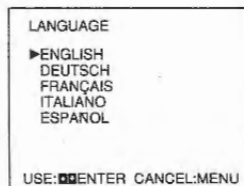

- 3 Press the CENT  $\updownarrow$  button repeatedly to move the cursor (▶) to the desired language, and press the ENTER button.
- 4 To quit the menu, press the MENU button three times.

# Adjusting the SC/H (Subcarrier to Horizontal)

When you edit or record a composite output signal with a VCR, you need to adjust the subcarrier-to-horizontal phase (SC/H).

Prepare special measurement equipment for the adjustment.

- 1 Press the MENU button twice.  
The MENU 2 screen appears.
- 2 Press the CENT  $\updownarrow$  button to move the cursor (▶) to SC/H ADJ and press the ENTER button.  
The adjustment value is displayed on the screen.

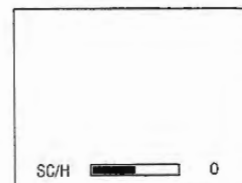

- 3 Press the CENT  $\updownarrow$  button to adjust the SC/H.
- 4 To quit the menu, press the MENU button twice.

# Using the HDTV output

When 1080i (HDTV) signal is output, adjust the vertical frequency to 60 Hz or 59.94 Hz according to the system of the monitor or video equipment connected to DSC-1024HD.

- 1 Press the MENU button twice.  
The MENU 2 screen appears.
- 2 Press the CENT  $\updownarrow$  button to move the cursor (▶) to 1080I 60/59.94, and press the ENTER button.  
The 1080I setting screen appears.

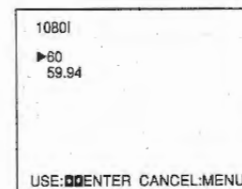

- 3 Press the CENT  $\updownarrow$  button to select the vertical frequency of the connected system: 60 (Hz) or 59.94 (Hz), and press the ENTER button.
- 4 To quit the menu, press the MENU button twice.

## Note

When the output format is anything other than 1080i, you cannot switch to the 1080I setting screen. "NOT APPLICABLE" appears on the screen instead.



# Troubleshooting

If you are having problems, check the countermeasures for each symptom listed below.  
If the problem still cannot be solved, contact your nearest service facility.

Symptom	Check and countermeasure
No picture	<ul style="list-style-type: none"> <li>• Check if the indicator of the ON/OFF switch is lit. If not, make sure the power cord is connected and press the ON/OFF switch.</li> <li>• Check if the monitor/projector is turned on.</li> <li>• Check if the OUT indicator matching the monitor/projector is lit (see page 49).</li> <li>• Check if the monitor/projector is connected securely using the built-in test patterns.</li> <li>• Check if the correct INPUT SELECT button has been pressed.</li> <li>• Check if the input source equipment is turned on and input source is being played.</li> <li>• Check if one of the IN indicators is lit. If not, make sure the input source equipment is connected correctly. If equipment is connected to VIDEO 3 IN, set the SYNC AUTO/ON G selector to AUTO. If equipment is connected to VIDEO 2 IN, check if the NORMAL/COMP selector is set to the correct position.</li> </ul>
The sync signal streaks on the screen (does not stabilize).	<ul style="list-style-type: none"> <li>• If the VIDEO OUT D-sub connector is used, check to see if the RGB/YBR selector and SYNC SEP/COMP selector of the VIDEO OUT section are correct.</li> </ul>
Picture is greenish.	<ul style="list-style-type: none"> <li>• If the input source equipment is a computer connected to VIDEO 3 IN, set the SYNC AUTO/ON G selector to ON G.</li> <li>• Equipment which emits both external sync signals and sync on green signals cannot be connected to VIDEO 2 IN connectors. When connecting Silicon Graphics Inc. computers or some Macintosh models, connect them to VIDEO 3 IN connectors and set the SYNC AUTO/ON G selector to ON G.</li> </ul>
Picture is purplish.	<ul style="list-style-type: none"> <li>• If the input source equipment is a computer connected to VIDEO 3 IN, set the RGB/YBR selector to RGB.</li> </ul>
Picture is too large.	<ul style="list-style-type: none"> <li>• Adjust the size of the picture using the SIZE buttons.</li> <li>• Press the ZOOM - button to set the zooming size to x1.</li> </ul>
Picture is enlarged vertically.	<ul style="list-style-type: none"> <li>• When the output format is 1080i, the picture is enlarged if output to a monitor with the conventional Japanese HDTV format (1035i format). In this case, set the 1035/1080 format selector of the monitor to 1080, or adjust the vertical size using the V SIZE +/- button.</li> </ul>
Remote commander does not function.	<ul style="list-style-type: none"> <li>• Check the type of your remote commander and set the COMMAND MODE selector correctly (see page 42).</li> <li>• This unit functions with remote commanders for Sony TVs and projectors only.</li> <li>• Disconnect the plug from the CTRL S IN jack.</li> </ul>
Remote commander malfunctions.	<ul style="list-style-type: none"> <li>• Set the COMMAND MODE selector to OFF.</li> </ul>
The POWER indicator flashes.	<ul style="list-style-type: none"> <li>• The built-in thermal protector may have functioned. Check if the surrounding temperature is too high.</li> <li>• Press the POWER switch to turn the unit off. Then press it again and check the POWER indicator. If the POWER indicator still flashes, consult your dealer.</li> <li>• Press the POWER switch to turn the unit off. Then press it again and check the fan. If the fan does not work, consult your dealer.</li> </ul>
"NOT APPLICABLE" is displayed on the screen.	<ul style="list-style-type: none"> <li>• You have pressed a button that does not function in the current operating mode.</li> </ul>
"NO REFERENCE" is displayed on the screen, and the GEN-LOCK indicator on the front panel flashes.	<ul style="list-style-type: none"> <li>• The black burst signal is not input to the VIDEO 1 IN connector when GEN LOCK is set to ON on the MENU 2 screen.</li> </ul>
"WRONG REFERENCE" is displayed on the screen, and the GEN-LOCK indicator on the front panel flashes.	<ul style="list-style-type: none"> <li>• The format of the black burst signal input from the signal generator does not correspond with the output signal format (NTSC or PAL) of the converter.</li> </ul>

# Specifications

## Signal input

VIDEO 1 IN	<p>Composite video/reference input BNC connector × 2 (loop-through), 75 ohms (automatic termination) NTSC<sub>3.58</sub>/PAL<sub>4.43</sub>, 1 Vp-p typical Black burst signal for the gen-lock function*</p> <p>S video (Y/C) 4-pin mini DIN connector × 2 (loop- through), 75 ohms (automatic termination) Y: 1 Vp-p typical, sync negative C: 0.286 Vp-p (NTSC)/0.3 Vp-p (PAL) typical</p>
VIDEO 2 IN	<p>RGB/component/composite video D-sub 15-pin, 3-row × 2 (loop- through), 75 ohms/high impedance R/G/B: 0.714 Vp-p H/V or composite sync: 1 to 5 Vp-p Y/B-Y/R-Y: 0.7 Vp-p (NTSC/PAL, sync on Y) Composite video: 1 Vp-p (NTSC<sub>3.58</sub>/PAL<sub>4.43</sub>)</p>
VIDEO 3 IN	<p>RGB/component D-sub 15-pin, 3-row connector × 2 (loop-through), 75 ohms/high impedance R/G/B: 0.714 Vp-p (sync on G acceptable) H/V or composite sync: 1 to 5 Vp-p Y/B-Y/R-Y: 0.7 Vp-p typical (NTSC/PAL, sync on Y)</p>
AUDIO IN 1, 2, 3 (L/R) RCA pin jack, more than 10 kilohms 0 dBs (1 Vrms) max.	

## Signal output

VIDEO OUT	<p>Composite video BNC connector, 75 ohms typical NTSC<sub>3.58</sub>/PAL<sub>4.43</sub>, 1 Vp-p typical</p> <p>S video (Y/C) 4-pin mini DIN connector, 75 ohms typical Y: 1 Vp-p typical, sync negative C: 0.286 Vp-p (NTSC)/0.3 Vp-p (PAL) typical</p> <p>RGB/component D-sub 15-pin, 3-row connector, 75 ohms typical R/G/B: 0.714 Vp-p with external sync H/V or composite sync: TTL sync negative Y/B-Y/R-Y: 0.7 Vp-p typical (sync on Y)</p>
AUDIO OUT (L/R)	<p>RCA pin jack Audio gain: ± 1.0 dB typical Total harmonic distortion: less than 1%, 1 Vrms</p>

## Video processing

Capture range	Horizontal rate: 15.6 to 70 kHz, Vertical rate: 50 to 120 Hz
Preset signal	Input: 10 formats Output: 7 formats Gen-lock output: NTSC or PAL (See page 49.)
Video memory	1,152 × 1,152 × 24 bits (RGB total)
Sampling rate	14.3 to 40 MHz offset phase max. (equivalent to 80 MHz sampling)
Output pixel clock	14.3 to 50 MHz max.

## General

Power requirements	100 to 120 V AC, 50/60 Hz, 0.4 A 200 to 240 V AC, 50 - 60 Hz, 0.25 A
Power consumption	30 W (max. in operation) 3 W (power off)
Operation temperature	0 to 35°C (32 - 95°F)
Dimensions	424 × 44 × 354 mm (w/h/d) (16 <sup>3/4</sup> × 1 <sup>3/4</sup> × 14 inches) excluding bracket and legs
Mass	Approx. 4.1 kg (9 lb 1 oz)
Supplied accessories	AC power cord (1) Signal cable (1) Screws for mounting bracket kit MB- 510 (4)

## Optional accessories

Rack mount bracket MB-510
SMF-400: D-sub 15-pin (male) to 5 BNC cable
SMF-401: D-sub 15-pin (male) to D-sub 15-pin (male) cable
Remote commander RM-854, RM-1271, RM-PJ1292, RM-PJ350

### \* Note on the gen-lock function

The reference signal should comply with SMPTE 170M (NTSC) or ITU-R624 (PAL).

V  
V  
V  
Pr  
IN  
NI  
PA  
OT  
31.  
31.  
OT  
37k  
OT  
48k  
64k  
—  
• H. S  
• Inp  
• "H  
"HI  
VESA  
VGA  
Mac (I  
Design

## Signal assignment

**VIDEO 2 IN connector (D-sub 15-pin, 3-row)**

**VIDEO 3 IN connector (D-sub 15-pin, 3-row)**

**VIDEO OUT connector (D-sub 15-pin, 3-row)**

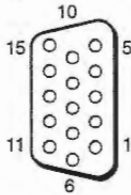

**Y/C IN/OUT connector (4-pin mini DIN)**

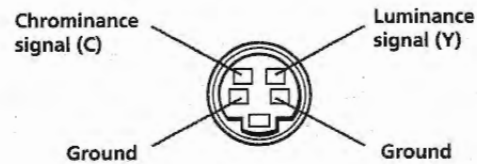

Pin No.	Signal
1	Red video or R-Y
2	Green video, Y or composite video*
3	Blue video or B-Y
4	Ground
5	Ground
6	Red ground
7	Green ground
8	Blue ground
9	Not used
10	Ground
11	Ground
12	Not used
13	H sync or composite sync
14	V sync
15	Not used

\* Composite video signals apply to the VIDEO 2 IN connector only.

## Preset signals

Indicator		Signal standards		
INPUT	OUTPUT	Name	Scan lines	Line rate/field rate
NTSC	NTSC	NTSC	525 lines total (interlaced)	15.73 kHz/59.94 Hz
PAL	PAL	PAL	625 lines total (interlaced)	15.63 kHz/50.00 Hz
OTHERS	—	HDTV 1920 × 1035 (Japan)	1035 lines active (interlaced)	33.75 kHz/59.94 Hz
31.5k	—	VGA Text	400 lines active (non-interlaced)	31.47 kHz/70.11 Hz
31.5k	31.5k	VGA 640 × 480	480 lines active (non-interlaced)	31.47 kHz/59.94 Hz
OTHERS	—	Mac 13" mode	480 lines active (non-interlaced)	35.00 kHz/66.67 Hz
37k	37k	VESA 800 × 600	600 lines active (non-interlaced)	37.88 kHz/60.32 Hz
OTHERS	—	Mac 16" mode	624 lines active (non-interlaced)	49.73 kHz/74.55 Hz
48k	48k	VESA 1024 × 768	768 lines active (non-interlaced)	48.36 kHz/60.00 Hz
64k	64k	VESA 1280 × 1024	1024 lines active (non-interlaced)	63.95 kHz/59.94 Hz
—	1080i	HDTV 1920 × 1080	1080 lines active (interlaced)	33.75 kHz/60 Hz, 59.94 Hz

- H. SYNC and V. SYNC of all the output signals are negative.
- Input HDTV signals as RGB signals only. HDTV signals cannot be input as YPbPr signals.
- "HDTV 1920 X 1035 (Japan)" conforms to the ARIB 1125/60 format HDTV studio system standards.  
"HDTV 1920 X 1080" conforms to both the ARIB 1125/60 format HDTV studio system standards and the SMPTE 274M standards.

VESA is a registered trademark of Video Electronics Standards Association.

VGA and SVGA are registered trademarks of International Business Machines Corporation.

Mac (Macintosh) is a registered trademark of Apple Computer, Inc.

Design and specifications are subject to change without notice.