

TECHNICAL BULLETIN INDEX
Sorted by Bulletin Number
04/03/86

No.	Catalog Description	Rev. Date
2000:001	26-5140 When first powered up video is not synchronized.	12/08/83
2000:002	26-5103 Improper power lead dress may cause AC noise.	12/08/83
2000:003	26-5103 Installation of the expansion RAM bank.	12/16/83
2000:004	26-5103 Modification to cure video jitter.	12/19/83
2000:005	26-5103 Memory parity errors caused by U59.	02/27/84
2000:006	26-5111 Complete or partial blank video display.	01/18/84
2000:007	26-5140 Modification to Rev. PP2 Hires Graphics board.	01/16/86
2000:008	26-5141 Installation of the color chip set.	01/18/84
2000:009	26-5140 Indentify proper PAL for Hires operation.	01/18/84
2000:010	26-5103 Both floppy drive activity LED's light.	01/24/84
2000:011	26-5103 Shorting power supply pulling system down.	03/16/84
2000:012	26-5104 Component changes on hard drive controller board.	04/12/84
2000:013	26-5103 Assure proper operation of Memory Parity Interupt.	05/10/84
2000:014	26-5161 To correct timing on external 256k memory board.	01/30/85
2000:015	26-5103 To correct blowing of power line fuse.	05/29/84
2000:016	26-5103 Ensure proper seating of all expansion PCB's.	04/24/85
2000:017	26-5104 Random problems with internal hard drive.	09/11/84
2000:018	26-5103 Possible switch wire damage.	06/13/84
2000:019	26-5103 Possible misalignment of CPU chip in socket.	07/11/84
2000:020	26-5103 Parity modification for units with date code AA.	10/10/85
2000:021	26-5103 Random dots appearing on color monitor screen.	04/24/85
2000:022	26-5103 Installation of hard drive upgrade kit.	08/14/84
2000:023	26-5103 To increase stability of power supply under load.	08/21/84
2000:024	26-5104 Intermittent 'Bad Command Reading Drive C' error.	10/10/84
2000:025	26-5140 Eliminate random memory errors on graphics board.	10/16/84
2000:026	26-5161 Memory timing and refresh problems on ext. RAM PCB	06/28/85
2000:027	26-5103 Test points for new Mitsubishi floppy drive.	11/21/84
2000:028	26-5104 Installation of secondary hard drive.	01/29/85
2000:029	26-5140 "Reflection" of video column zero on right side.	04/24/85
2000:030	26-5103 Insure proper connection of mother brd to main PCB	05/22/85
2000:031	26-5104 To remove a possible interrupt conflict on the bus	02/03/86
2000:032	26-5103 Correct polarity of External Memory Parity Int.	11/15/85
2000:033	26-5161 To prevent a false memory cycle.	11/15/85
2000:034	26-5161 To correct parity latch timing.	02/10/86
2000:035	26-5164 Mods to allow two or more SDLC (serial) boards.	11/26/85
2000:036	26-5161 Eliminate a timing problem with BUSARDY* signal.	12/05/85
2000:037	26-5164 To eliminate data errors on the Serial (SDLC) brd.	12/06/85
2000:038	26-5143 8087 Numeric Coprocessor upgrade procedures.	01-06-86
2000:039	26-5103 Identifying faulty 80186 CPU chips.	03/12/86
2000:040	26-5104 False trigger could cause garbage written to HD.	12/30/85
2000:041	26-5104 To improve stability of VCO.	01/22/86
2000:042	26-5103 Eliminate random reboot because of power supply.	02/04/86
2000:43	26-5103/4 Substitution of tandy 2000 keyboard	04/15/86
2000:44	26-5127 Mods to allow HDC touse external Drive C	09/08/87
2000:45	26-5103 Enable proper modem operation	11/19/87
2000:46	26-5161/2 Permit use of Samsung RAM chips etc.	06/01/88

TANDY COMPUTER PRODUCTS

DATE: December 8, 1983
REVISION DATE: April 18, 1988
BULLETIN NO: 2000:1
PRODUCT: 26-5140 High Resolution Graphics PCB
SUBASSEMBLY: AX-9450 Graphics PCB
SUBASSEMBLY REVISION: Rev. PP2

PURPOSE: When first powered up, video is not synchronized. Problem may be intermittent.

DISCUSSION:

It is possible for the signals on the High Resolution Graphics board to not be properly synchronized after RESET. The following modification will prevent this problem.

Revision blank boards (DWG# 1700261) already have this modification done.

PROCEDURE:

Make the following cuts:

- 1) Cut the trace running between U64 pin 1 and U64 pin 2 on the solder side of the board.
- 2) On the component side of the board, cut the trace from U64 pin 3 to the feedthrough. Cut the trace at the feedthrough.
- 3) On the component side of the board, cut the trace from U64 pin 4 to the feedthrough. This feedthrough can be found just above and to the right of the cut made in step 2 above. The trace leaving the feedthrough runs under U64. Cut the trace at the feedthrough.

Make the following jumpers:

- 1) Jumper U63 pin 1 to U64 pin 3.
- 2) Jumper U64 pin 2 to U64 pin 4.
- 3) Jumper U64 pin 1 to the feedthrough cut loose from U64 pin 4 in step 3 above.

DATE: December 8, 1983
REVISION DATE: December 8, 1983
BULLETIN NO.: 2000:1
PRODUCT: 26-5140 High-resolution Graphics PCB
SUBASSEMBLY: Hires Graphics (Color or B/W) Board Rev PP2, Rev blank.

PURPOSE: When first powered up video is not synchronized. Problem may be intermittent.

DISCUSSION:

It is possible for the signals on the High Resolution Graphics board to not be properly synchronized after RESET. The following modification will prevent this problem.

PROCEDURE:

Make the following cuts on on the COMPONENT SIDE of the hires video board:

- 1) Cut the trace running between U64 pin 1 and U64 pin 2
- 2) Cut the trace from U64 pin 3 to the feedthrough. Cut the trace at the feedthrough.
- 3) Cut the trace from U64 pin 4 to the feedthrough. This feedthrough can be found just above and to the right of the cut made in step 2 above. The trace leaving the feedthrough runs under U64. Cut the trace at the feedthrough.

Make the following jumpers:

- 1) jumper U63 pin 1 to U64 pin 3
- 2) Jumper U64 pin 2 to U64 pin 4
- 3) Jumper U64 pin 1 to the feedthrough cut loose from U64 pin 4 in Step 3 above.

DATE: December 8, 1983
 REVISION DATE: December 8, 1983
 BULLETIN NO.: 2000:2
 PRODUCT: 26-5103/04 Model 2000 computer
 SUBASSEMBLY: Power supply and wiring harness

PURPOSE: Improper lead dress may caused AC hum to appear in the DC power lines. This can cause intermittent disk I/O errors or other problems.

DISCUSSION:

If the AC and DC wiring harnesses inside the power supply cage are not properly dressed (arranged) AC hum can be induced into the DC wiring harness. Fluctuations in the DC power lines can cause all manner of problems and many of them may be intermittent.

The AC and DC wiring harness must be kept separated as far as is practically possible.

PROCEDURE:

```

*****
**  !!WARNING!!  !!WARNING!!  !!WARNING!!  !!WARNING!!  !!WARNING!!  **
*****
**                                                                 **
**  ALWAYS UNPLUG THE AC CORD FROM BOTH THE UNIT AND THE WALL BEFORE **
**  ATTEMPTING REPAIRS.  NEVER ATTEMPT POWER SUPPLY REPAIRS WITH THE **
**                                                                 **
**                AC LINE CONNECTED.                **
**                                                                 **
*****
    
```

The AC and DC harnesses can be identified by color as well as location. The AC lines are BLUE and BROWN. These lines can be found running from the AC receptacle to the power switch, and to other connectors which may need 120 volts AC power.

The DC lines are colored RED, ORANGE, BLACK, and WHITE. They can be found running from a connector on the front of the power supply to the main logic PCB, the disk drives, and the expansion board bus PCB.

The AC harness (BLUE and BROWN) should be dressed as closely as possible to the power supply PCB. Use a pencil or dowel rod to push the AC harness down as close as possible to the power supply PCB.

There are four wires coming out of the front of the main transformer -- two RED and two BLACK. One of the RED wires goes to the LEFT (as viewed from the rear) of the large heatsink, the other RED wire goes to the RIGHT. The LEFT hand RED wire should be dressed against the PCB as well. Push it down against the AC wiring harness.

The DC wiring harness is routed over the transformer and through the U-shaped cutout in the metal frame. Add a self-sticking wire-tie mount (Radio Shack catalog number 278-441) to the inside (power supply side) of the metal frame approximately 1 inch forward of the U-shaped cutout. Use a wire-tie to tie the DC cable harnesses to this wire tie mount.

DATE: December 16, 1983
REVISION DATE: December 16, 1983
BULLETIN NO.: 2000:3
PRODUCT: Model 2000 26-5103
SUBASSEMBLY: 128K RAM Expansion 26-5160

PURPOSE: To explain the installation of the expansion RAM bank

DISCUSSION: This is a very straightforward upgrade, no cuts or jumpers are required.

PROCEDURE:

Step 1: Gain access to the main logic board by removing the six pan screws (four hex head, two small phillips) and swing the board out. You will now see the main ram board on nylon standoffs, with a large red header plug which is plugged to a header on the logic board.

Step 2: The expansion ram board plugs into the main ram at the black plug on the end of the board. Be sure to use the standoffs provided with the expansion ram board to hold it in place similarly to the main ram.

Step 3: Reassemble the unit and power it up. You should see 256K at the top of the screen. Boot up the diagnostics disk and run the memory verify test, starting at bank 0, for 2 banks. Select the short test and run for at least 5 passes.

DATE: December 19, 1983
REVISION DATE: December 19, 1983
BULLETIN NO.: 2000:4
PRODUCT: Model 2000 26-5103
SUBASSEMBLY: 26-5140 Hi-Res Graphics Board with 26-5141 Color Chips

PURPOSE: Modification to cure video jitter or complete unlocking on color monitor which cannot be adjusted out by a PLL alignment.

DISCUSSION: This modification is **MANDATORY** to all Hi-Res Graphics boards for the Model 2000. It will eliminate problems encountered with the Hi-Res board not wanting to lock in on the PLL alignment (C64 on the main logic board).

PROCEDURE: Find U19 on the Hi-Res board and cut pins 5 & 6 from the board. Tie these to pin 7 using wire wrap wire.

DATE: December 19, 1983
REVISION DATE: February 27, 1984
BULLETIN NO.: 2000:5
PRODUCT: Model 2000 26-5103,
SUBASSEMBLY: Main logic board AX-9452

PURPOSE: Memory parity errors caused by U59.

DISCUSSION: Some problems have been encountered with memory parity errors on the Model 2000. These errors can occur immediately upon boot-up or after a period of time. These problems have been attributed to defective delay lines at U59. These delay lines were manufactured by Valor, and have two different factory codes printed on them. The ones marked Hong Kong and have a date code greater than or equal to 8339 are ok. The delay lines marked Mexico and have a date code greater than or equal to 8345 are ok. They are also marked with numbers designating their delay time. The ones marked 5125 (125ns) are installed as a straight replacement. The delay lines marked 5150 (150ns) need to be modified to work properly.

PROCEDURE:

Check the date code on the U59 delay line, if it falls below the above specified date codes then order a replacement. If the time delay number is 5125 then replace with an MX-6029 order under stock number 26-5103.

Another delay line available is coded with a 5150 time delay number. This means it is a 150ns delay line, and can be modified to work in this machine. This delay line can be ordered under AMX-5756, stock number 26-5103.

Cut the trace at pin 6 of U59 on the foil side, and run a jumper from the feed through at the other end of this trace, to pin 10 of U59. This will tap the 150ns delay line at the proper point. This alternate delay line should be used only in the event that the MX-6029 is not available.

After replacing the delay line run memory diagnostics to verify proper operation.

DATE: January 18, 1984
REVISION DATE: January 18, 1984
BULLETIN NO.: 2000:6
PRODUCT: 26-5111 Monochrome Monitor
26-5112 Color Monitor
SUBASSEMBLY: N/A

PURPOSE: Possible cause of complete or partial blanking of display.

DISCUSSION/PROCEDURE:

The Model 2000 has the ability to change intensity levels of the characters going to the monitor. This feature allows you to highlight different areas of the display.

If the display should appear to go completely blank at times, or if just parts of it should blank while running diagnostics or other application programs, first check the brightness and contrast controls on the monitor. If these controls are a little low and the program displays low intensity characters you may not be able to see those characters even though everything is functioning properly.

TRS-80®

DATE: January 16, 1984
REVISION DATE: January 16, 1986
BULLETIN NO.: 2000:7
PRODUCT: Hires Graphics Board 26-5140/5141
SUBASSEMBLY: AX-9450 Hires Graphics Board

PURPOSE: Modifications to REV PP2 version of the Hires Graphics PCB.

DISCUSSION: The following is a list of modifications to REV PP2 version of the Hires Graphics Board. These modifications should have already been done to all boards you receive. This list is intended as a reference in case you encounter a loose or broken jumper wire on one of these boards.

Rev PP2

CUTS:

U7 Pin 3 (component side near feedthrough)
U29 Pin 8 (foil side between Pin 8 and feedthrough)
U64 Pin 1 (component side between Pins 1 & 2)
U64 Pin 3 (near feedthrough)
U64 Pin 4 (to the right of cut at U64 Pin 3)
U37 Pin 2 (between pin and feedthrough)
U34 Pin 2 (between pin and feedthrough)
Pull pins 5 & 6 of U19 out of PCB

JUMPERS:

U10 Pin 15 -- U27 Pin 14
RP2 Pin 4 -- U34 Pin 7
U8 Pin 17 -- U25 Pin 7
U59 Pin 14 -- U43 Pin 3
U59 Pin 12 -- U43 Pin 4
U5 Pin 2 -- U21 Pin 17 -- U43 Pin 11
U7 Pin 3 -- U23 Pin 13
U55 Pin 2 -- U56 Pin 2
U54 Pin 19 -- U54 Pin 1
U14 Pin 6 -- U18 Pin 2
U44 Pin 18 -- U23 Pin 4 or U6 Pin 3
U44 Pin 17 -- U23 Pin 8 or U7 Pin 17
U44 Pin 12 -- U23 Pin 7 or U6 Pin 17
U64 Pin 2 -- U64 Pin 4
U64 Pin 3 -- U63 Pin 1
U34 Pin 2 -- U14 Pin 1

Radio Shack®

TRS-80®

U19 Pin 7 -- U19 Pin 6 -- U19 Pin 5
Feedthrough at U29 Pin 8 -- U29 Pin 7
Feedthrough at U64 Pin 4 -- U64 Pin 1
Feedthrough at U37 Pin 2 -- Feedthrough at U34 Pin 2

PROCEDURE: Check all boards for broken or incorrect modifications if you are having problems with one.

Radio Shack®

DATE: January 18, 1984
REVISION DATE: January 18, 1984
BULLETIN NO.: 2000:8
PRODUCT: Color Hires Upgrade 26-5141
SUBASSEMBLY: Monochrome Hires Board 26-5140

PURPOSE: To outline the installation of the color chip set.

DISCUSSION: This upgrade consists of pluggable chips and one cut to the PCB.

PROCEDURE: Install the TMS 4416-150 RAM chips at U2 through U9.
Install the 74F245 chips at U40,41,43, and 44.
Install the 25LS22 chips at U20,22,24, and 38.
Cut Etch-Link 1 near RP-5.

Run the Hires diagnostics to insure proper operation as a hires color board.

TANDY COMPUTER PRODUCTS

DATE: January 18, 1984
REVISION DATE: July 12, 1988
BULLETIN NO: 2000:9
PRODUCT: 26-5140/5141 Hires Graphics Board
SUBASSEMBLY: AX-9450
SUBASSEMBLY REVISION: All

PURPOSE: To help identify proper PAL to use for both monochrome and color hires operation.

DISCUSSION: Some hires graphics boards have a PAL installed at U55 which can present problems with monochrome graphics. The incorrect PAL's have a sticker on them marked 55 or 55M. The correct PAL is marked 55C or 55540F. This PAL will work as either a monochrome or color hires.

PROCEDURE: Inspect board for proper PAL. If it is incorrect, order a replacement under part number MXP-0023, Stock number 26-5141.

DATE: January 18, 1984
REVISION DATE: January 18, 1984
BULLETIN NO.: 2000:9
PRODUCT: Hires Graphics Board 26-5140/5141
SUBASSEMBLY: PAL U55

PURPOSE: To help identify proper PAL to use for both monochrome and color hires operation.

DISCUSSION: Some hires graphics boards have a PAL installed at U55 which can present problems with monochrome graphics. The incorrect PAL's have a sticker on them marked 55 or 55M. The correct PAL is marked 55C. This PAL will work as either a monochrome or color hires.

PROCEDURE: Inspect board for proper PAL. If it is incorrect, order a replacement under part number MX 6018, Stock 26-5141.

DATE: January 24, 1984
REVISION DATE: January 24, 1984
BULLETIN NO.: 2000:10
PRODUCT: Model 2000 26-5103/4
SUBASSEMBLY: Mitsubishi Drives AXX-5043

PURPOSE: Both drive activity lights run with Rev. A main logic PCB.

DISCUSSION: Due to the decoding circuitry on the Rev. A main logic board a cut must be made on the drive logic boards in the Mitsubishi drives to prevent both activity lights from lighting simultaneously. The DI jumper is located in the upper right hand corner of the drive logic board next to the main plug. Its exact position is between the drive select jumpers and P7 staking pins. The in-use and drive select signals are nanded together which cause both lights to illuminate at the same time. Cutting this jumper disables the in-use input to the drive (P1-4). This will cause the LED to illuminate only when the drive is selected.

PROCEDURE: Cut the DI jumper on both drive logic boards. This will cause the activity light to be illuminated by the drive select signal.

DATE: March 16, 1984
REVISION DATE: March 16, 1984
BULLETIN NO.: 2000:11
PRODUCT: 26-5103/4 Model 2000
SUBASSEMBLY: ATA-1054 Power supply assembly

PURPOSE: To correct possible shorting of power supply causing system to appear dead.

DISCUSSION:

Some of the reset switches for the Model 2000 are connected to the main logic board by a shielded cable. When the cable is attached to the reset switch it is possible for the braid of the cable to touch the heat sink which is connected to CR13 and CR14 of the power supply. These two rectifiers are part of the first stage of the DC power source. When the braid of the cable touches the heat sink it shorts the power supply to ground.

PROCEDURE:

1. Remove the top case of the Model 2000. Between the floppy drives and the power supply you should be able to see cables coming from the power supply to the main logic board. The two pin cable going to J8 is the reset cable. If this cable has a bare braided wire than this Technical Bulletin could apply and you should proceed with the following steps.

NOTE: If the Model 2000 has the built in hard drive you will not be able to see the cables going to the main logic board without removing the hard drive bubble.

2. Remove the top shield of the power supply assembly. This can be done by removing three screws on the right side, two screws on the left side, and two screws in the back.
3. The power supply should now be exposed and you should be able to see the connectors going to the reset switch. Remove the reset cable and wrap the bare braid with electrical tape or heat shrink tubing. This will prevent the wire from shorting to the heat sink.
4. Reassemble and check the unit for proper operation.

Radio Shack®

DATE: April 12, 1984
REVISION DATE: April 12, 1984
BULLETIN NO.: 2000:12
PRODUCT: 26-5103/4 Model 2000 with Hard Drive
SUBASSEMBLY: AX-9451 Hard Drive Controller PCB

PURPOSE: Outline proper component values and changes.

DISCUSSION/PROCEDURE: Some early production hard drive controller boards were missing a resistor (R28), had two wrong valued capacitors installed (C5 and C6), and had one capacitor which was not grounded properly (C8). All Tandy 2000 hard drive controller boards should be checked for the following:

1. Make sure R28 has a 470 ohm 1/4 watt 5% resistor installed in that silk screen position.
2. Check C5 and C6 to insure 100 pfd capacitors are installed and not 150 pfd capacitors.
3. Check C8 to insure that the open pin is attached to the ground plane nearest it (Refer to Figure 1).

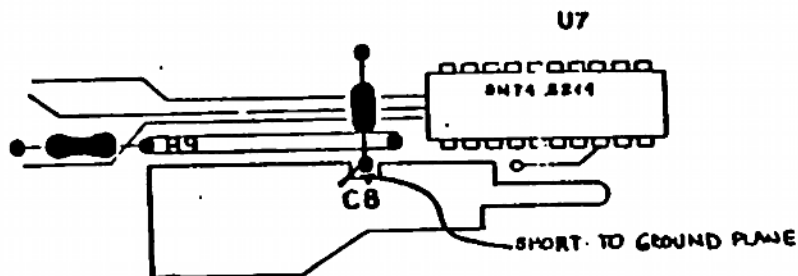

Figure 1

Radio Shack

TB 2000:12
PAGE 1 OF 1

DATE: May 10, 1984
REVISION DATE: May 10, 1984
BULLETIN NO.: 2000:13
PRODUCT: 26-5103/4 Model 2000
SUBASSEMBLY: AX-9452 Main PCB

PURPOSE: To assure proper operation of Memory Parity Interrupt line.

DISCUSSION:

The Memory Parity Interrupt signal (MEMINT00) is generated by U87 on the main PCB. This chip is a 74LS38 NAND gate which is an open collector device. It is required to pull-up the outputs of this device for proper operation.

PROCEDURE:

Add a 2.2k 1/4 watt resistor from U87 pin 11 to U87 pin 14.

A 2.2k resistor is available from National Parts under part number N-0216EEC and catalog 26-9999R.

DATE: May 10, 1984
REVISION DATE: January 30, 1985
BULLETIN NO.: 2000:14
PRODUCT: 26-5161 External 256K Expansion board.
SUBASSEMBLY: N/A

PURPOSE: To correct timing of memory data latch.

DISCUSSION:

To assure compatability between the External Memory Expansion boards and the Main PCB, timing of the data between the two boards must be correct. To accomplish this the data latch enable (LE) for the 74F373's on the Memory Expansion board must be driven from the signal STROBE* instead of CASP*.

**** Compliance With This Bulletin Is Manditory ****

PROCEDURE:

On the trace side of the board add a jumper wire from U46 pin 12 to U31 pin 16.

On the component side cut pin 12 of U46 away from the chip.

TANDY COMPUTER PRODUCTS

DATE: May 29, 1984
REVISION DATE: April 11, 1988
BULLETIN NO: 2000:15
PRODUCT: 26-5103/5104 Tandy 2000
SUBASSEMBLY: N/A
SUBASSEMBLY REVISION: N/A

PURPOSE: To correct blowing of power line fuse.

DISCUSSION:

During power-up of the Model 2000 there is a current surge which exceeds the 4 amp rating of the power line fuse causing it to blow. Since this surge is very short and normal operation falls below the 4 amp rating, replacement of the "normal" blow fuse with a "slow" blow fuse is required.

PROCEDURE:

The specified replacement is a 4 Amp 125v SLO-BLO fuse. National Parts carries a 4 amp 250v SLO-BLO fuse that is an acceptable substitute. It may be found under:

Part Number: HF-0211

Catalog Number: 26-5104

DATE: May 29, 1984
REVISION DATE: May 29, 1984
BULLETIN NO.: 2000:15
PRODUCT: 26-5103/4 Model 2000
SUBASSEMBLY: N/A

PURPOSE: To correct blowing of power line fuse.

DISCUSSION/PROCEDURE:

During power up of the Model 2000 there is a current surge which exceeds the 4 amp rating of the power line fuse causing it to blow. Since this surge is very short and normal operation falls below the 4 amp rating, replacement of the "Normal" blow fuse with a "Slow" blow fuse is required.

A 4 Amp 125v SLO-BLO fuse can be ordered from National Parts under part number AHF-1303 and catalog number 26-5104.

Date: August 2, 1984
To: All Computer Service Personnel
From: Ken Brookner, Technical Support
Subject: Technical Bulletin 2000:16 is Incorrect
File: 2000:16

Technical Bulletin 2000:16, revision date May 21, 1984, is incorrect. Please discard Technical Bulletin 2000:16 and insert this memo in it's place. A new Technical Bulletin 2000:16 will be issued at a later date.

DATE: April 24, 1985

REVISION DATE: April 24, 1985

BULLETIN NO.: 2000:16

PRODUCT: 26-5103/4 Tandy 2000

SUBASSEMBLY: All expansion boards

PURPOSE: Ensure proper seating of all Tandy 2000 expansion PCB's.

DISCUSSION: The plastic nylatch plungers used to secure Tandy 2000 expansion boards to the card cage may contribute to intermittent problems. Expansion boards sometimes unseat themselves causing intermittent operation of the computer. Replacing these nylatch plungers with machine screws does a better job of seating, grounding and securing expansion boards to the card cage.

**** Compliance With This Bulletin Is Mandatory ****

PROCEDURE: Replace ALL nylatch plungers securing expansion boards to the Tandy 2000 card cage with machine screws. These screws are available through National Parts under:

Catalog Number 26-5104, Part Number AHD-2974

Radio Shack

DATE: May 31, 1984
REVISION DATE: September 11, 1984
BULLETIN NO.: 2000:17
PRODUCT: 26-5104 Model 2000
SUBASSEMBLY: Hard Drive Controller AX-9451

PURPOSE: Random problems with access of, or formatting of the internal hard drive.

******* THIS TECHNICAL BULLETIN IS MANDATORY *******

DISCUSSION:

Some Model 2000 computers with the built in hard drive will be slow to boot up, or will lock out random tracks during format. This has at times been found to be caused by faulty connection of the grounding tab on the controller board. If you are having random problems with a hard drive, this is one of the first things to check and modify as outlined below.

PROCEDURE:

Remove the plastic snap retaining plug on either side of the Controller board and replace with sheet metal screws. The screws will give the required grounding for the board.

Order the Screw from National Parts with the following information:

Screw Sheet Metal Part # AHD-2974 Cat.# 26-5104

Radio Shack®

DATE: June 13, 1984
REVISION DATE: June 13, 1984
BULLETIN NO.: 2000:18
PRODUCT: 26-5103/4 Model 2000
SUBASSEMBLY: ATA-1054 Power supply

PURPOSE: Prevent power and reset switch wiring from being damaged.

DISCUSSION/PROCEDURE:

Due to the close fit of the power and reset switch wiring harness to the large heat sink on the power supply, it is possible the heat sink could rub against the wires causing a short. To prevent this, an insulating edge protector should be installed on the right side of the heat sink.

The edge protector is available from National Parts under part number AHC-3100 and catalog 26-5103.

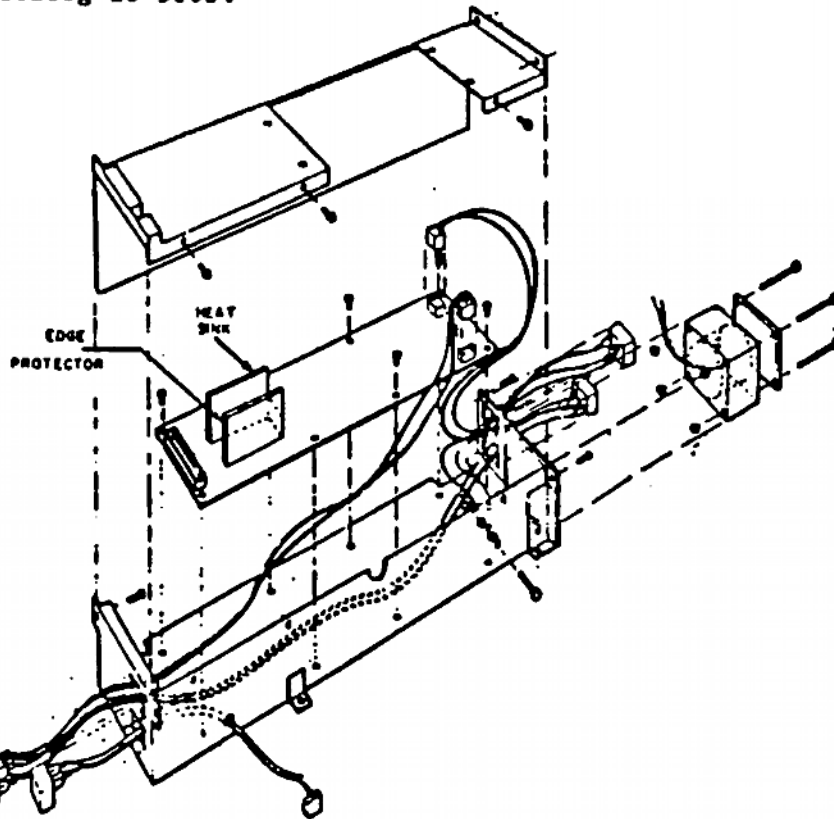

Radio Shack®

DATE: July 11, 1984
REVISION DATE: July 11, 1984
BULLETIN NO.: 2000:19
PRODUCT: 26-5103/4 Model 2000
SUBASSEMBLY: AX-9452 Main Logic Board

PURPOSE: Possible misalignment of CPU chip in socket.

DISCUSSION:

The 80186 CPU chip used in the Model 2000 is packaged in a 68 pin ceramic leadless chip carrier. This type of package reduces the size of the overall IC, however it also decreases the space between each IC pin. When replacing the CPU chip in its socket, care must be taken to properly seat and align the IC. Failure to do so could cause several pins to short resulting in intermittent operation to complete failure of the computer.

PROCEDURE:

The CPU chip can be removed from the socket by carefully pushing out on two corners of the metal hold down strap. This should cause the metal strap to snap out from under the plastic socket and pop off.

When replacing the CPU chip place the IC in the socket such that the index corner of the IC package aligns with the index corner of the socket. Hook two corners of the hold down strap on the edges of the socket. Then with a finger placed through the middle of the strap press on the IC while you snap on the other two corners. Pressing on the CPU chip in this manner will help avoid the IC from becoming misaligned with the shock of snapping on the strap.

Radio Shack

DATE: July 26, 1984
REVISION DATE: October 10, 1985
BULLETIN NO.: 2000:20
PRODUCT: 26-5103 Tandy 2000
SUBASSEMBLY: AX-9452 Main PCB

PURPOSE: Parity modification for units with date code AA.

DISCUSSION:

Early production units had a PAL chip (U95) which did not properly handle memory parity. These units can be identified by the date code AA stamped near the serial number. Any Tandy 2000 with this date code must have U95 replaced with the latest IFL. The new IFL will have a paper sticker labeled 95671A. The first two digits, '95', indicate the location number (U95) and the last four digits, '671A', indicate the IFL's program checksum.

PROCEDURE:

Replace U95. U95 is available from National Parts under part number MX-6009 and catalog number 26-5103.

DATE: July 19, 1984

REVISION DATE: April 24, 1985

BULLETIN NO.: 2000:21

PRODUCT: 26-5103/4 Tandy 2000

SUBASSEMBLY: AX-9450 Hires Board (Rev. PP2, Blank)

PURPOSE: To eliminate random dots intermittently appearing on the color monitor screen when in Hires mode.

DISCUSSION: There is a timing problem on the Hires graphics board which will cause random dots to appear on the color monitor screen intermittently when in the Hires mode. This problem will will also cause a burst of random errors while running the Hires memory diagnostic after an extended period of time (Normally 1/2 to 2 hours).

PROCEDURE: Check Pal U69 on all Hires boards for a dot label on it marked 'N' or a paper sticker marked '697C6F'. If not so marked replace it with New Pal MX-6023 under catalog number 26-5103 from National Parts. Then perform the following modification.

1. Cut pins 1 and 15 of U34, U35, U36 and U37 at the chip and bend them up away from the board.
2. Jumper all of the above pins to the new Pal U69 pin 14.
3. Run a jumper from U69 pin 11 to U19 pin 11.
4. After this is done, run Hires diagnostics for proper operation.

DATE: August 14, 1984
REVISION DATE: August 14, 1984
BULLETIN NO.: 2000:22
PRODUCT: Model 2000, 26-5103
SUBASSEMBLY: Hard Disk Upgrade Kit

PURPOSE: Detail installation of hard disk in Model 2000.

DISCUSSION: Install hard drive upgrade kit as outlined below.

PROCEDURE: Remove top cover from computer. Remove access plate on top of main power supply. Install hard drive power supply as follows:

- (1) Hook extra AC connector (blue-brown) from main supply AC harness to connector next to fuse on hard drive supply.
- (2) Use one of the green ground wires supplied to run from spade lug on hard drive supply to grounding bolt on the inboard side of main supply case.
- (3) Connect Red plugs on DC harness supplied with kit to J5 & 6 on hard drive supply. Mount supply component side down in the hole where the access cover used to be. Be sure to correctly place grommet on DC harness through slot in hard drive supply to avoid chafing.

Using hardware supplied, mount single plug and connector cables at the top slot in the card cage. The standoffs mounted to the right of the motherboard are what this plug mounts to. Route cables through the opening directly below where plug mounts.

Mount hard drive bubble by latching the forward mounting tangs under the plastic tabs moulded into the bottom case of the computer. Be careful it is a TIGHT fit. Use other ground wire supplied to run from spade lug on bubble to screw hole in the rear mounting bracket. Run self tapping screws through mounting bracket and card cage chassis into case mounting holes.

Connect ribbon cables to bubble with cables dressed up.

Connect DC power harness to bubble.

Remove main logic board from computer and check the version of boot ROM's. If they are marked "Boot HD" or "Boot 103" then they will work as hard drive boot ROM's. If marked "Boot 16" then you will have to order hard drive boot ROM's under the numbers listed below. Align hard drive according to Tech Bulletin HD:22.

U47	MX-5996	26-5104
U48	MX-6006	26-5104

DATE: August 21, 1984
REVISION DATE: August 21, 1984
BULLETIN NO.: 2000:23
PRODUCT: 26-5103/4 Model 2000
SUBASSEMBLY: ATA-1054 Power Supply

PURPOSE: To increase stability of power supply under maximum load.

DISCUSSION:

The 95 watt power supply used in the Model 2000 has a load sense section. This section monitors the output load and adjusts the switching rate accordingly. A problem may occur where under maximum load conditions this control signal may become unstable. This can be corrected by changing two capacitors.

PROCEDURE:

Change C22 from a .01 uf capacitor to a .047 uf capacitor.
Change C23 from a .01 uf capacitor to a .047 uf capacitor.

The capacitors can be ordered from National Parts under part number CC-473JJGP and catalog number 26-9999C.

DATE: August 24, 1984
REVISION DATE: October 10, 1984
BULLETIN NO.: 2000:24
PRODUCT: 26-5103/4 Tandy 2000HD
SUBASSEMBLY: AX-9451 Hard Drive Controller

PURPOSE: To help eliminate intermittent 'Bad Command Reading Drive C' error messages and random flawed tracks appearing during hformat.

DISCUSSION: Address latch U33 is presently permanently enabled which can cause intermittent errors when reading and writing to the hard drive. To correct this problem pins 1 and 19 of U33 need to be cut away from ground and tied to the BUSALE line to allow the address latch to be disabled.

PROCEDURE: This modification is mandatory on ALL Tandy 2000 Hard Drive units in for repair.

1. On the component side of the board, cut pins 1 and 19 of U33 and bend them away from the PCB.
2. Run a jumper wire from pins 1 and 19 of U33 (component side of the board) to J5 pin 19A (foil side of the board). The routing of the wire can be accomplished two ways. If a hole is present near U33 pin 4 run the jumper wire through the hole to J5 pin 19A. If no hole is present run the wire to the side of J5 to J5 pin 19A.
3. Test the hard drive with diagnostics to insure proper operation.

DATE: October 16, 1984
REVISION DATE: October 16, 1984
BULLETIN NO.: 2000:25
PRODUCT: 26-5140 Model 2000 Graphics Board
SUBASSEMBLY: AX-9450 Graphics PCB

PURPOSE: To eliminate random memory errors.

DISCUSSION:

To eliminate random video memory errors a slight timing change is required. This is accomplished by changing the select for the video address decoders from the signal 186/SCN* to DYSCYC*.

PROCEDURE:

All cuts and jumpers should be made on the back side of the board.

1. Cut the trace between the Feed-Thru and U37 pin 2.
2. Cut the trace between the Feed-Thru and U34 pin 2.
3. Add a jumper wire from the Feed-Thru isolated in step 1 to the Feed-Thru isolated in step 2.
4. Add a jumper wire from U14 pin 1 to U34 pin 2.

DATE: September 6, 1984
REVISION DATE: June 28, 1985
BULLETIN NO.: 2000:26
PRODUCT: 26-5103/4 Model 2000
SUBASSEMBLY: 26-5161 External 256K Expansion board

PURPOSE: To correct memory timing and refresh addressing problems.

DISCUSSION: Two problems have been found on the 256K RAM expansion boards for the Model 2000. First of all on some very early revision blank boards, two traces have been reversed on the refresh counter causing the RAM to be refreshed every 4mS instead of every 2mS. Secondly some of the delay lines used in position U49 on these early boards did not meet our specifications. If problems with memory persist these delay lines should be suspect.

**** Compliance With This Bulletin is Mandatory ****

PROCEDURE:

- (1) To find out if the traces coming from the refresh counter have been reversed, set your digital ohmmeter to the 200 ohm scale, and measure the resistance from U66 pin 9 to pin 10 of any one of the RAM's. Also measure the resistance from U66 pin 7 to pin 9 of the RAM's. Both of these resistances should be approximately 28 ohms. If these measurements give a very high resistance reading then proceed with the next step, otherwise proceed to step 3.
- (2) If the resistances measured above were very high perform the following modification:
 - (a) Cut the trace, on the foil side of the board, leading to pin 9 of U66.
 - (b) Cut the trace, on the component side of the board, leading to pin 7 of U66.
 - (c) Solder a wire jumper from pin 9 of U66 to pin 10 of RP4.
 - (d) Solder a wire jumper from pin 7 of U66 to pin 9 of RP4.
- (3) If memory problems persist, suspect the delay line at position U49 and replace it with the part number below.

Delay line Valor DL2627 Part# MX-6576 Catalog# 26-5161

Radio Shack®

DATE: November 21, 1984
REVISION DATE: November 21, 1984
BULLETIN NO.: 2000:27
PRODUCT: 26-5103 Model 2000
SUBASSEMBLY: AXX-5050 Mitsubishi 5 1/4" drive

PURPOSE: To outline test point and alignment differences in new Mitsubishi 5 1/4" drives

DISCUSSION/PROCEDURE: We will be changing over to a new style Mitsubishi M4853-1 drive in the Model 2000. You may receive this drive as a replacement part or you may see it in newer machines. There are a few minor hardware differences between this and the older M4853 and it is these differences I will clarify with this bulletin.

To distinguish between the two drives, the new drive has a socket for a terminating resistor pack instead of the row of jumper plugs found on the other version. Also there is a small 4 pin connector J6 next to connector P4 on the newer version that is not present on the older version. The logic boards are not interchangeable between the two drives.

One of the major differences is the resistor pack mentioned above. This termination pack should be present only on drive #1 in a two drive system. If the system contains only one drive, then it must be terminated. This is done by installing a resistor pack in the newer drives or by installing the jumper plugs on the older drives. The test points are the same on both drives although they are located in different places. The alignment specifications are the same.

Two of the alignments are different from the M4853. They are the index assembly adjustment and the head radial adjustment. The index assembly adjustment is different only in that the assembly is mounted to the PCB on its own board and may be adjusted separately. In the case of head radial, there is a set screw located through a hole on the side of the carriage assembly. If, when positioned on track 32, the cat's eyes are not within specifications, loosen this set screw and adjust the carriage assembly slightly until the signal comes within specifications, then tighten the screw. All other adjustments are the same as before. Test points and jumpers for the newer drive are listed below.

Radio Shack

JUMPER	DESCRIPTION
DSX	Drive select
2S	Hold ready
HC	Head load always
MM	Motor on from drive select

Resistor pack RM1 installed only on last drive.

TEST POINT	DESCRIPTION
TP1	Track 00
TP3	Raw Data
TP9 & TP10	Analog Data
TP14	Index
TPG	Ground

TRS-80[®]

DATE: January 29, 1985
REVISION DATE: January 29, 1985
BULLETIN NO.: 2000:28
PRODUCT: 26-5103 Tandy 2000, two drive
26-5104 Tandy 2000, HD, and one disk drive
SUBASSEMBLY: AX-9577 Hard disk controller/interface

PURPOSE: Procedures for installation of a secondary hard drive on a Tandy 2000.

DISCUSSION: There are two types of hard drive controller boards you may find in the field. One has ribbon cable connections for a secondary drive, the other does not. If a customer wants to upgrade an existing 2000HD by adding a secondary drive, but the controller board does not have the ribbon cable connectors, that controller board must be replaced. New boot ROM's (U47 and U48) must also be installed. The part numbers for the replacement parts are.

Secondary cable kit for Tandy 2000, 26-5126
New style controller PCB, 26-5103 AX-9577 Disk Controller
U47, 26-5103 MX-6252 Boot ROM (474600)
U48, 26-5103 MX-6253 Boot ROM (484A00) HD

If the controller in the customer's computer does have the ribbon cable connectors, you need only verify the proper jumpering and termination of the secondary, and the presence of the correct boot ROM's.

Please note that since the secondary drive has its own connection to the controller board, both the primary and secondary will require termination. Also there is only one connector on the controller for a secondary. Therefore the maximum system configuration is one primary, and one secondary hard drive. The primary hard drive must always be internal.

Radio Shack[®]

PROCEDURE:

Step	If yes/next	If no
1.) Is there a primary drive installed in this unit?	step 2	see TB 2000:22
2.) Does the existing controller have connections for a secondary HD?	step 11	step 3
3.) *** CAUTION *** Insure a save has been made of all data on HD before proceeding Replace controller with AX-9577 Replace boot ROM U47 with MX-6252 Replace boot ROM U48 with MX-6253	step 4	
4.) Connect secondary to controller	step 5	
5.) Align Controller/adjust motor speed	step 6	
6.) Re-format primary and secondary with MSDOS version 2.11.01 or later.	step 7	
7.) Is system fully operational?	step 8	step 9
8.) Install Customer data.	end	
9.) Run HDREL, write with read verify. Test passed?	step 6	step 10
10.) Check all work.	step 5	
11.) Connect secondary to controller. *** CAUTION *** Insure a save has been made of all data on HD before proceeding	step 6	

DATE: April 24, 1985
REVISION DATE: April 24, 1985
BULLETIN NO.: 2000:29
PRODUCT: 26-5140 Tandy 2000 High Resolution Graphics board
SUBASSEMBLY: AX-9450 Graphic Monochrome PCB

PURPOSE: Correct "reflection" of video column zero on the right side of the video display.

DISCUSSION: On some Tandy 2000's while in monochrome screen mode 4, what appears to be a reflection of video column zero shows up on the right side of the video display as random dots.

PROCEDURE: Replace U70 on the HIRES graphics board with a 74F175. The part is available through National Parts under:

Catalog Number 26-6021, Part Number MX-2118

Radio Shack®

DATE: May 22, 1985
REVISION DATE: May 22, 1985
BULLETIN NO.: 2000:30
PRODUCT: 26-5103/4 Model 2000
SUBASSEMBLY: AX-9448 Motherboard

PURPOSE: To insure proper connection of Motherboard to Main logic board.

DISCUSSION: Due to improper seating of the mother board to the main logic board, intermittent bootup, video, or power problems may occur. The four screws which hold the main logic board and pan to the plastic case often times become stripped and creates a bad connection to the motherboard. To insure proper connection is made between the main logic and motherboard, a Retainer Kit is to be installed on the motherboard.

**** Compliance With This Bulletin Is Mandatory ****

PROCEDURE:

PARTS REQUIRED: (1) Retainer Kit (AHW-2605103) Catalog Number (26-5103/4)

Kit Contents: (2) Retainer Clips (2) #6 Lock Washers
(2) #2-56 x 5/8" Screws (2) #4 x 1/4" Screws

1. Remove main logic board and pan from bottom of unit.
2. Remove main logic board from pan and ream out the threads of the two standoff's under the (J5) connector to allow the two #2-56 x 5/8" screws provided to pass freely through the standoff's.

Note: If the screws and nuts securing (P6) to the motherboard are soldered together omit step 3.

3. (Refer to figure 1.) Remove screws and nuts holding (P6)(96-pin connector) to the motherboard. Replace the original screws with the #4 x 1/4" screws and the #6 lock washers. These are used to hold the retainer clips tightly in place.

4. (Refer to figure 1.) Place the retainer clips over the screw ears of the connector (P6) behind #6 lock washer if used.
5. Reattach the main logic board to the pan. Reinstall the mother board and insert the two screws into standoff's from bottom side. Thread the two screws into the retainer clips, pulling the two boards together for a tight fit. WARNING: Do not over tighten the screws or you will strip out the retainers.
6. Reassemble unit and test for proper operation.

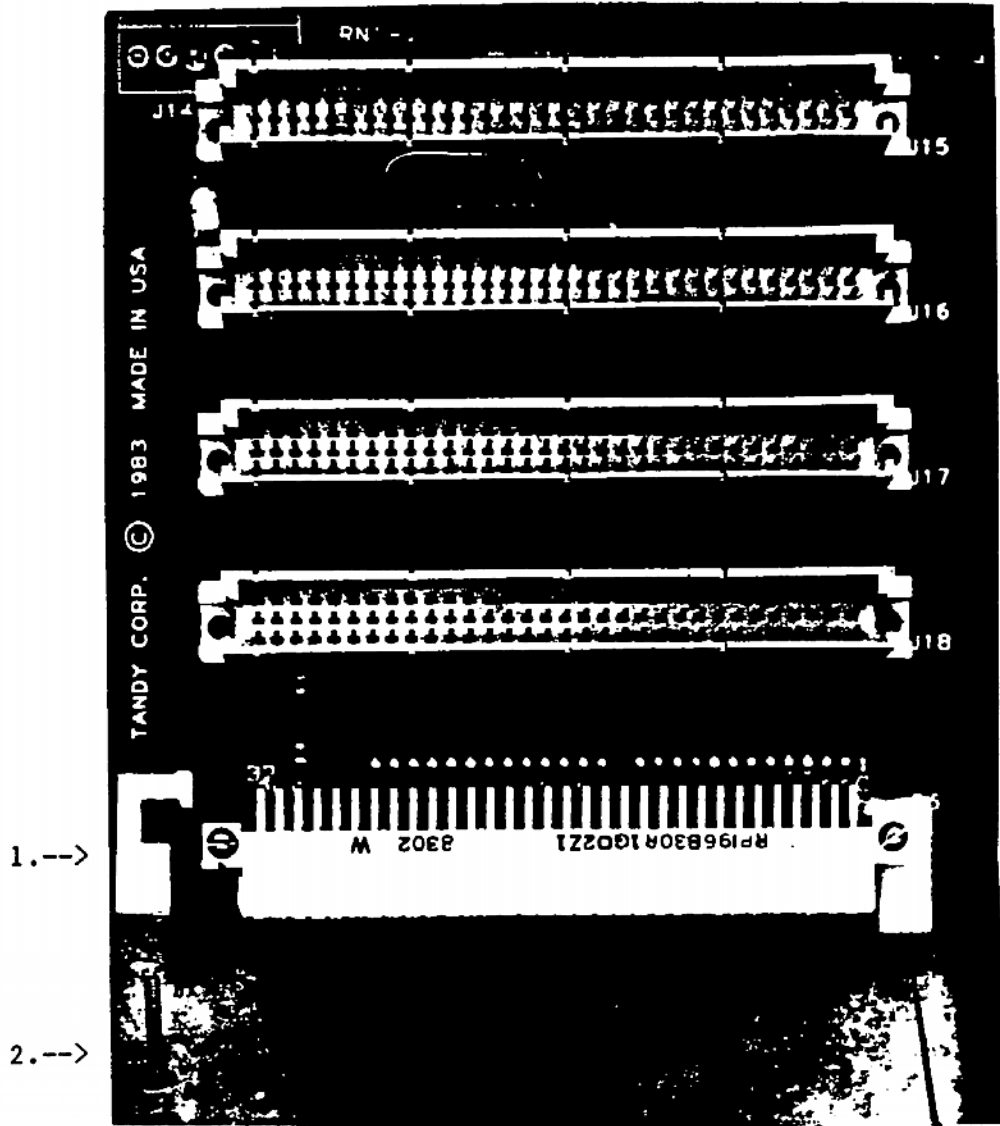

Figure 1.

Retainer Clip
Screw to be replaced

Retainer Clip
Mounted over ear

1. Retainer clip is inserted over (P6) connector mounting ears.
2. Insert screw through bottom of main logic board pan standoff's under the (J5) connector on main logic board.

DATE: September 20, 1985

REVISION DATE: February 3, 1986

BULLETIN NO: 2000:31

PRODUCT: 26-5104 Tandy 2000HD
26-5125 Tandy 2000 Hard Disk Upgrade

SUBASSEMBLY: AX-9451, AX-9575 Hard Disk Controller Board

SUBASSEMBLY REVISION: Rev. A

PURPOSE: To remove a possible interrupt conflict on the bus.

DISCUSSION:

The hard drive controller board interrupt is passed to the CPU by the 'BUSINT16' signal. However, this interrupt line is assigned to external I/O and DMA operations. If an external board requiring this line were installed it would be in conflict with the hard drive controller, causing a possible lockup. To avoid this, the hard drive's interrupt must be moved to the 'BUSINT17' signal line.

**** Compliance With This Bulletin Is Mandatory ****

PROCEDURE:

1. On the the HD controller PCB, cut the trace running from U32 pin 9 to J5-9B.
2. Add a jumper wire from U32 pin 9 to J5-17C.
3. Check for proper operation using HDREL and HDDIAG diagnostics.

Radio Shack®

DATE: November 15, 1985
REVISION DATE: November 15, 1985
BULLETIN NO: 2000:32
PRODUCT: 26-5103/4 Tandy 2000
SUBASSEMBLY: AX-9452 Main Logic Board

PURPOSE: To correct polarity of External Memory Parity Interrupt.

DISCUSSION:

The External Memory Parity Interrupt signal going to the interrupt controller on the main logic board has the incorrect polarity. This causes any parity error that occurs on the external memory boards to be improperly handled leading to a false parity error message or no message when a true error occurs.

**** Compliance With This Bulletin Is Mandatory ****

PROCEDURE:

To correct the polarity, the signal needs to be inverted. This can be accomplished by a spare gate at location U120.

1. On the component side, cut the trace that runs between R32 and R33. This trace connects a lower feed-through, located above U98 and U99, and an upper feed-through located below U66.
2. Add a jumper wire from the lower feed-through isolated in step 1, to U120 pin 12.
3. Add a jumper wire from the upper feed-through isolated in step 1, to U120 pin 13.
4. Check operation with all memory diagnostics.

Radio Shack

DATE: November 15, 1985
REVISION DATE: November 15, 1985
BULLETIN NO: 2000.33
PRODUCT: 26-5161/2 External Memory Board
SUBASSEMBLY: AX-9469 External Memory PCB

PURPOSE: To prevent a false memory cycle.

DISCUSSION:

It has been found that under certain conditions the refresh count circuitry could cause a false memory cycle. To prevent this, the refresh memory cycle needs to be qualified with the latched refresh signal.

**** Compliance With This Bulletin Is Mandatory ****

PROCEDURE:

1. On the component side, cut the trace at U48 pin 3.
2. Add a jumper wire from U48 pin 3 to U28 pin 6.
3. Check operation with all memory diagnostics.

Radio Shack

DATE: November 19, 1985
 REVISION DATE: February 10, 1986
 BULLETIN NO: 2000:34
 PRODUCT: 26-5161/2 External Memory Board
 SUBASSEMBLY: AX-9469 External Memory Board
 SUBASSEMBLY REVISION: All revisions

PURPOSE: To correct parity latch timing.

DISCUSSION:

To guarantee the proper parity latch timing, sufficient set-up and hold times must be maintained. The PAL at location U42 with the checksum 31CC or 31AB, has been found not to consistently supply this proper timing.

**** Compliance With This Bulletin Is Mandatory ****

PROCEDURE:

```

*****
*                                     *
*           ONLY Checksums of         *
*                                     *
*           31EF   or   3577          *
*                                     *
*           are acceptable PALs for U42. *
*                                     *
*****
    
```

1. Replace the PAL at location U42 with a new PAL having a checksum of 31EF, or 3577. Note, the PAL's label has the location number (42) first and then the four digit checksum (31EF or 3577).
2. For PALs with a checksum of 3577 ONLY, bend pin 5 up out of the socket and jumper it to pin 20.
3. Check operation with memory diagnostics.

The new PAL can be ordered from National Parts under part number MX-6175 and catalog 26-5161.

TRS-80[®]

DATE: November 26, 1985

REVISION DATE: November 26, 1985

BULLETIN NO: 2000:35

PRODUCT: 26-5103/4 Tandy 2000
26-5164 Tandy 2000 Serial Expansion Board

SUBASSEMBLY: AX-9452 Main Logic Board
AX-9043 SDLC (serial expansion) board

PURPOSE: To describe modifications to allow two or more SDLC (serial expansion) boards to function properly.

DISCUSSION:

In order for two or more SDLC (serial expansion) boards to function properly, the signal BUSINT03 must be low active on the bus. This necessitates modifications to the main logic board of the Model 2000 and also a jumper change on the SDLC boards.

NOTE: This modification is only required when more than one SDLC board is to be used.

PROCEDURE:

The modifications to the main logic board are as follows:

- 1) Cut the trace which runs between C4 and C5 on the component side of the board.
- 2) Jumper the feedthrough isolated by the cut in step (1) to U23 pin 11 on the component side of the board.
- 3) Jumper U23 pin 10 to U42 pin 21 on the component side of the board.

The jumper change for the SDLC (serial expansion) boards is:

- 1) Move jumper E8-E9 to E8-E10 on all SDLC boards in the system. (This enables use of a low active BUSINT03).
- 2) The first SDLC board should have E5-E6 jumpered (denotes first board in system).
- 3) The second SDLC board should have E5-E7 jumpered (denotes second board in system).

Radio Shack[®]

DATE: December 5, 1985
REVISION DATE: December 5, 1985
BULLETIN NO: 2000:36
PRODUCT: 26-5161/2 External Memory Expansion Board
SUBASSEMBLY: AX-9469 External Memory Expansion Board

PURPOSE: To eliminate a timing problem with the BUSARDY* signal.

DISCUSSION:

The BUSARDY* (BUS Asynchronous ReaDY) signal is used by an I/O device to tell the CPU to wait until it has finished it's task. The PAL at location U30 controls the timing of this BUSARDY* signal for the External Memory Board. U30 with a checksum of 2518 (labeled '302518') has been found to incorrectly handle this signal causing the CPU to continue execution before the Expansion Memory Board has completed it's cycle.

**** Compliance With This Bulletin Is Mandatory ****

PROCEDURE:

1. Replace the PAL at location U30 with a new PAL having a checksum of 249C (the sticker label will read '30249C').
2. Check for proper operation with memory diagnostics.

The new PAL is available from National Parts under part number MX-6177 and catalog 26-5161.

DATE: December 6, 1985
REVISION DATE: December 6, 1985
BULLETIN NO: 2000:37
PRODUCT: 26-5164 Serial Expansion Board
SUBASSEMBLY: AX-9043 Serial Expansion Board

PURPOSE: To eliminate data errors.

DISCUSSION:

A timing problem with the enable signal (245EN*) of the data bus buffer U26 may cause the buffer to be enabled or disabled at the wrong time causing data errors. To insure proper timing, the enable signal for the buffer must be further qualified. This is accomplished with a new PAL at U19 and one at U33. U19 had previously been responsible for generation of the buffer enable signal (245EN*). The following procedure causes U33 to generate the enable using several signals (RD*, DT/R*, and BUSA07-BUSA15) to qualify it.

**** Compliance With This Bulletin Is Mandatory ****

PROCEDURE:

1. Replace the PAL at location U19 with the new one having a checksum of 7A00. The sticker label should read '197A00'. The PAL is available from National Parts under part number MX-4199 and catalog 26-5164.
2. Replace the PAL at location U33 with the new one having a checksum of 07D2. The sticker label should read '3307D2'. The PAL is available from National Parts under part number MX-4198 and catalog 26-5164.
3. On the solder side, cut the trace between U19 pin 13 and the feedthru next to R5.
4. On the solder side, add the following jumper wires:
 - 1) From U33 pin 11 to U19 pin 13.
 - 2) From U33 pin 12 to U19 pin 8.
 - 3) From U33 pin 13 to U32 pin 11.
 - 4) From U33 pin 14 to U26 pin 19.
 - 5) From U33 pin 18 to U16 pin 1.
5. Check for proper operation using the SDLC diagnostic.

Radio Shack®

DATE: January 6, 1986
REVISION DATE: January 6, 1986
BULLETIN NO: 2000:38
PRODUCT: 26-5143 8087 Numeric Coprocessor
SUBASSEMBLY: AX-0112 Upgrade kit

PURPOSE: Upgrade procedure and service information for the 8087 Numeric Coprocessor.

DISCUSSION:

The iAPX 8087 is a numeric coprocessor that extends the Tandy 2000 central processing unit (CPU) to include native opcodes for floating point operations. This extension appears to the programmer as part of the processor, i.e.: no special initialization instructions need to be executed to support the 8087. It interprets instructions in tandem with the CPU and recognizes operations that it must perform as part of the instruction stream.

Included in this bulletin are the procedures to upgrade a Tandy 2000 with the 8087 numeric coprocessor and service information on the 8087 PCB. The service information contains a short theory of operation, a schematic, and PCB layout.

UPGRADE PROCEDURE:

The following procedure outlines the steps required to install the upgrade kit. This kit includes a specially modified Tandy 2000 main PCB mounted on a new pan, the 8087 coprocessor PCB, and a new power supply top cover.

1. Turn off the power to all peripherals and the Tandy 2000. Disconnect the power cords from the outlets.
2. Disconnect and remove the video display, the keyboard cable and the keyboard from the Tandy 2000.
3. Remove the two (2) mounting screws at the lower rear of the Tandy 2000. Slide the top cover forward to release the catches at the front, then lift the top cover off the computer.

Radio Shack[®]

4. Remove all the plug-in cards from the card cage. Referring to the Technical Bulletins, verify all modifications have been made to these plug-in boards. If any of these modifications have not been completed do them at this time, then run all applicable diagnostic tests to verify correct operation.
5. Remove the hard disk power supply (if installed).
6. Remove the top cover of the main power supply and replace it with the new cover supplied with the upgrade kit. Note, if the unit has an internal hard drive it must be removed to allow removal of the power supply cover.
7. Reinstall the hard disk power supply (if applicable).
8. Turn the Tandy 2000 over, remove the four (4) mounting screws which attach the metal chassis of the main logic PCB assembly to the base.
9. Carefully disconnect the connections to the main logic PCB and remove the PCB and metal chassis.
10. There are two case standoffs underneath the main logic PCB. To allow room for the coprocessor PCB the standoff located near the motherboard must be trimmed down, using a large pair of wire cutters or tin snips, as close to the screw as possible.

```
*****  
*                                                                 *  
*           DO NOT FORCE THE BOARD.                               *  
*                                                                 *  
*   If any force is required to seat the boards                 *  
*   the standoff has not been cut short enough.                 *  
*   Note, a shorter screw may be required to                    *  
*   avoid shorting the coprocessor PCB.                          *  
*****
```

11. Carefully reattach the connections to the new main logic PCB assembly supplied with the kit (includes metal chassis and 8087 coprocessor PCB).
12. Reassemble the computer and reconnect all cables and power cords.
13. Check for proper operation with system and coprocessor diagnostics.

Radio Shack[®]

SERVICE INFORMATION:

The iAPX 8087 identifies numeric instructions by monitoring the bus activity of the 80186 CPU. Two sets of status lines (S0* - S2* identify the type of bus cycle, and QS0 - QS1 identify queue operations) inform the 8087 of the bus cycle being run as well as the status of the CPU's internal queue (the 80186 maintains a queue up to six bytes long from which opcodes are fetched). A certain class of instruction codes (ESCAPE opcodes) have been reserved for the numeric coprocessor extension. In response to an ESC opcode, the 80186 computes the EA (Effective Address) identified by the opcode, and does a single memory read from that address. The 8087 decodes the ESC instruction tandem with the 80186 and (if necessary) grabs both the data and the address generated by the CPU. If further bytes need to be fetched to complete the instruction, the 8087 informs the 80186 of its status by outputting BUSY (active high while doing a numeric operation). The CPU has an instruction (WAIT, no operands) that waits for its TEST* (active low) to go active before it continues. All 86 family assemblers insert a WAIT instruction before floating point instructions unless explicitly directed not to do so. That way, the CPU does not embark on a new numeric instruction before the last one has completed its execution. Interface between the 8087 and the 80186 is performed by the 82188. This device provides system READY synchronization, converts the RQ/GTn* bus master control convention of the 8087 to the HOLD/HDLA convention of the 80186, synchronizes the QSn* lines of the 80186 to the 8087, and provides RD*, WR*, and ALE strobes by decoding the S0* - S2* status lines that are common to both the 80186 and the 8087.

Additional logic on the circuit board regenerates the MCS0* and MCS1* (Memory Chip Select 0 and 1, active low in 00000H - 1FFFFH for MCS0* and in 20000H - 3FFFFH for MCS1*) that is generated by the 80186 so that the 8087 may access these areas also. In order for the 8087 to properly track accesses to the UCS* (Upper Chip Select, active low in F8000H - FFFFFH), SRDY (Synchronous Ready, active high) must be held inactive to maintain the appearance of a three wait state access (the 80186 is programmed by the boot ROM to run a three wait state access to this area).

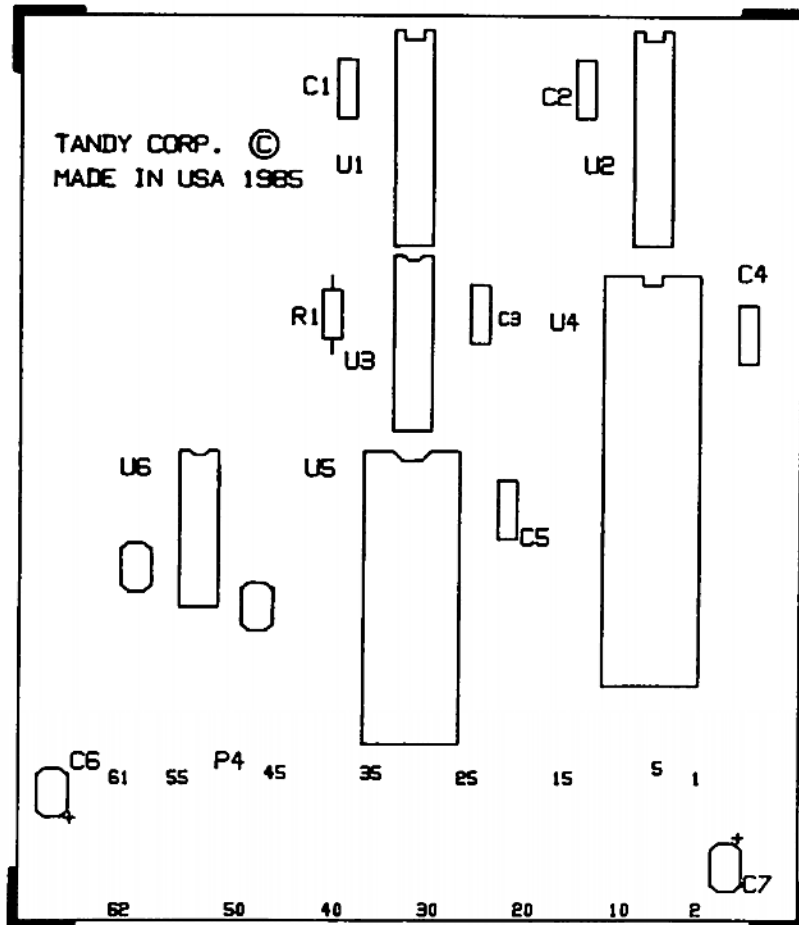

Tandy 2000 8087 Numeric Coprocessor Component Layout

DATE: December 13, 1985
REVISION DATE: March 12, 1986
BULLETIN NO: 2000:39
PRODUCT: 26-5103/4 Tandy 2000
SUBASSEMBLY: AX-9452 Main Logic PCB

PURPOSE: Identifying faulty 80186 CPU chips.

DISCUSSION:

Several versions of the 80186 CPU have been used in the Tandy 2000. Some of these may have missing command functions. Some are 6 MHz speed chips instead of the required 8 MHz. These CPU chips may not exhibit any problems, or only have problems with certain application programs such as a CAD package. Proper identification, and replacement if necessary, is required to insure proper operation.

**** Compliance With This Bulletin Is Mandatory ****

PROCEDURE:

Identification markings may be made on either side of the chip. If the Intel name and logo are not visible from the top side, then the markings are made on the contact, or bottom side of the chip. This requires removal of the chip from it's socket for identification. Refer to Technical Bulletin 2000:19 for CPU removal and replacement procedures.

There are two items to check, clock speed and version number. If either one, or both of these numbers are incorrect the chip must be replaced. Figure 1 shows a typical 80186 CPU chip.

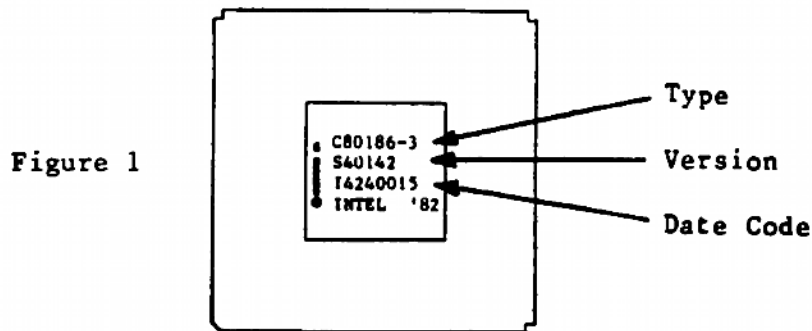

Radio Shack®

Note the type number may be prefixed with either a "C" or an "R". Either of these is correct. This prefix is Intel's chip package code.

Clock speed is determined by the suffix of the type number:

Clock Speed		
C80186	8 MHz	Good (No Suffix)
C80186-3	8 MHz	Good
C80186-6	6 MHz	<u>BAD</u>

The version number is located directly below the type number and begins with a letter 'S'. There are three acceptable version numbers:

Acceptable Versions	
S40142	Good
S40173	Good
blank	Good

A "blank" version number indicates that there is not a number starting with an "S" between the type and date code. The date code number will appear directly below the type.

```

*****
*
*           IMPORTANT NOTE FOR COPROCESSOR USERS           *
*
*   A Tandy 2000 with the coprocessor installed MUST NOT have an *
*   "S" version number on the 80186 CPU chip. The CPU version *
*   must be a blank. *
*
*****
    
```

A new 80186 CPU chip is available from National Parts under part number MX-5993 and catalog 26-5103.

DATE: December 30, 1985

REVISION DATE: December 30, 1985

BULLETIN NO: 2000:40

PRODUCT: 26-5104 Tandy 2000HD
26-5125 Tandy 2000 10 MEG Hard Drive

SUBASSEMBLY: AX-9451 Internal Hard Drive Controller PCB
AX-9575 Internal Hard Drive Controller with secondary connectors

PURPOSE: To correct false triggering of P4SEL* and MR* one-shot which could cause garbage to be written to the hard drive.

DISCUSSION:

An active Peripheral Chip Select 4 (PCS4*) signal indicates an I/O port address in the range of 0200H to 027FH. The Tandy 2000 Hard Drive Controller uses the even address ports between 0270H and 027EH as well as 026CH. Therefore the PCS4* signal is qualified with address line 0 to produce the Peripheral 4 SElect (P4SEL*) signal, which indicates an even port address within the hard drive controller I/O area. When disabled the address buffer outputs are floating which has been found to cause address 0 to incorrectly qualify the PCS4* signal which in turn causes an invalid selection of the hard drive controller board. The resulting invalid P4SEL* signal will then trigger the one-shot U36 generating an invalid MR* signal. This could cause a bad write to the hard drive destroying data or possibly the boot track.

**** Compliance With This Bulletin Is Mandatory ****

PROCEDURE:

A pull-up resistor must be added to the A0 line to prevent an invalid qualification of the PCS4* signal. The MR* one-shot must be further qualified with the ReaD* Internal Bus (RD*IB) signal to prevent an invalid MR*.

1. Add a 470 ohm resistor from U19 pin 2 to U19 pin 14. A 470 ohm resistor is available from National Parts under part number N-0169EEC, catalog 26-9999R.
2. On the component side, cut the trace between U36 pin 2 and U36 pin 3.
3. Add a jumper wire from U32 pin 14 to U17 pin 9.
4. Add a jumper wire from U17 pin 8 to U36 pin 2.
5. Check operation with system diagnostics.

Radio Shack®

DATE: January 22, 1986
REVISION DATE: January 22, 1986
BULLETIN NO: 2000:41
PRODUCT: 26-5104 Tandy 2000 Hard Drive
SUBASSEMBLY: AX-9451 Hard Drive Controller
SUBASSEMBLY REVISION: All Revisions

PURPOSE: To improve stability of VCO.

DISCUSSION: This bulletin is intended as an aid in recognizing an improperly operating VCO trimmer capacitor (C8) in this hard drive controller. The capacitor, if acting improperly, will cause the hard drive to show excessive errors during intensive hard drive access. The capacitor may be identified as being faulty if the VCO error voltage at test point 7 rises as heat is applied from either a heat gun or lamp. This voltage should decrease with heat.

**** Compliance With This Bulletin Is Mandatory ****

PROCEDURE: Apply heat to the logic board while monitoring the pre-adjusted VCO error voltage at test point 7. If this voltage rises as heat is applied, replace the capacitor with the part number listed below. Be sure to test the new part in the same manner after realigning the controller.

Capacitor, trim 7-60pf Part# ACF-7364 Catalog# 26-5125

DATE: February 4, 1986
REVISION DATE: March 26, 1986
BULLETIN NO: 2000:42
PRODUCT: 26-5103/4 Tandy 2000
SUBASSEMBLY: ATA-1054 Power Supply
SUBASSEMBLY REVISION: All Revisions

PURPOSE: To eliminate random reboot due to power supply shutting down.

DISCUSSION:

The power supply for the Tandy 2000 has two potentiometers. One to adjust the +5 volts (R10) and another to adjust the +12 volts (R8). During operation it has been found that these potentiometers will change value. This could cause the voltage to increase which in turn causes the power supply to go into current limiting mode; shutting itself down and rebooting the computer.

PROCEDURE:

To eliminate this voltage fluctuation, the potentiometers must be replaced with fixed resistors. Two items must be noted here. First, the required resistance may not be a standard value resistor which will indicate that a series and/or parallel resistor combination must be used. Secondly, the +5 volt potentiometer will require two resistors (or combinations) where as the +12 volt will only require one resistor (or combination). This is because the +12 volt potentiometer's slide arm is connected to one of its fixed legs.

1. Gain access to the power supply's potentiometers by removing the top case of the Tandy 2000 and the top metal shield of the power supply.
2. With **ALL** of the customers expansion boards installed, turn the unit on and measure the +5 and +12 volt supplies and adjust them if necessary.

+5 volt range = 5.00 to 5.25

+12 volt range = 11.75 to 12.25

+12 volts can be measured at J2 pins 1 or 2 and adjusted by R8.

+5 volts can be measured at J2 pins 8 through 12 and adjusted by R10.

Ground is at J2 pins 3 through 7.

3. Turn the unit off and remove the power supply PCB.
4. Referring to the figure below remove R10 (+5 volt), observing the leg orientation. With an OHM meter measure the resistance between Leg 1 and Leg 2. This is the first fixed resistor value. Measure the resistance between Leg 3 and Leg 2. This is the second fixed resistor value.
5. Install the first fixed resistor between the holes on the power supply PCB vacated by Leg 1 and Leg 2. Install the second fixed resistor between the holes vacated by Leg 3 and Leg 2. This completes the replacement of the +5 volt potentiometer.
6. Remove R8 (+12 volt), observing the leg orientation. The power supply PCB has Leg 3 connected to Leg 2. For this reason only one fixed resistor is required. The value for this fixed resistor can be measured between Leg 1 and Leg 2.
7. Install the fixed resistor between the holes on the power supply PCB vacated by Leg 1 and Leg 2. This completes the replacement of the +12 volt potentiometer.
8. Reinstall the power supply PCB and check for proper voltage levels on the +5 volt and +12 volt sections.

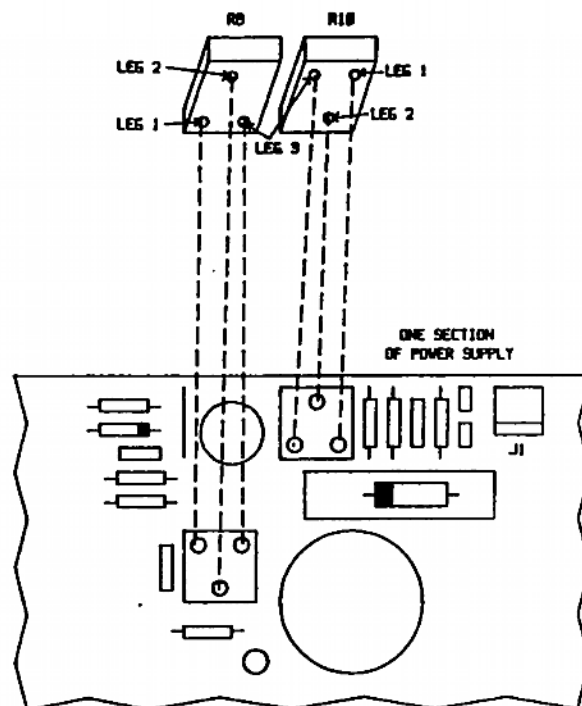

DATE: April 15, 1986
REVISION DATE: April 15, 1986
BULLETIN NO: 2000:43
PRODUCT: 26-5103/4 Tandy 2000
SUBASSEMBLY: AXX-0220 Keyboard
SUBASSEMBLY REVISION: All Revisions

PURPOSE: Substitution of Tandy 2000 keyboard with the Tandy 1000 keyboard.

DISCUSSION:

Under certain conditions National Parts may substitute the Tandy 1000 keyboard (AXX-0236) for the Tandy 2000 keyboard (AXX-0220). The two keyboards can easily be identified by the INSERT and DELETE keys. On the Tandy 1000 there is a "+" on the INSERT key and a "-" on the DELETE key. The Tandy 2000 keyboard however does not have these labels. The following procedure outlines the steps required to use the new keyboard.

PROCEDURE:

1. Remove the nine (9) keyboard case screws and lift off the top case.
2. Before removing the keyboard plug from the header, make note of the wire colors to each pin.

Tandy 2000 Cable	
Pin	Wire Color
1	Black
2	-----
3	Green
4	Yellow
5	Red
6	Shield

On the Tandy 2000 keyboard pin 2 of the 6 pin connector is not used.

3. Remove the keyboard cable. The keyboard cable headers of the two keyboards are different, for this reason remove both keyboard headers and install the old header on the new keyboard.

DATE: April 15, 1986
REVISION DATE: April 15, 1986
BULLETIN NO: 2000:43
PRODUCT: 26-5103/4 Tandy 2000
SUBASSEMBLY: AXX-0220 Keyboard
SUBASSEMBLY REVISION: All Revisions

PURPOSE: Substitution of Tandy 2000 keyboard with the Tandy 1000 keyboard.

DISCUSSION:

Under certain conditions National Parts may substitute the Tandy 1000 keyboard (AXX-0236) for the Tandy 2000 keyboard (AXX-0220). The two keyboards can easily be identified by the INSERT and DELETE keys. On the Tandy 1000 there is a "+" on the INSERT key and a "-" on the DELETE key. The Tandy 2000 keyboard however does not have these labels. The following procedure outlines the steps required to use the new keyboard.

PROCEDURE:

1. Remove the nine (9) keyboard case screws and lift off the top case.
2. Before removing the keyboard plug from the header, make note of the wire colors to each pin.

Tandy 2000 Cable	
Pin	Wire Color
1	Black
2	-----
3	Green
4	Yellow
5	Red
6	Shield

On the Tandy 2000 keyboard pin 2 of the 6 pin connector is not used.

3. Remove the keyboard cable. The keyboard cable headers of the two keyboards are different, for this reason remove both keyboard headers and install the old header on the new keyboard.
 4. Connect the cable to the new keyboard observing the wire orientation as noted in step 2.
 5. Exchange the 'INSERT' and 'DELETE' keytops, reassemble the keyboard and check for proper operation with system diagnostics.
-

DATE: February 18, 1987

REVISION DATE: September 9, 1987

BULLETIN NO: 2000:44

PRODUCT: 26-5127 External only Hard Drive Controller

SUBASSEMBLY: AX-2605127 External hard drive controller PCB
AX-9575 Internal/external hard drive controller PCB

SUBASSEMBLY REVISION: All

PURPOSE: To describe the original and enhanced modifications to the hard drive controller to allow an external secondary drive to be used as drive C:

DISCUSSION: This bulletin outlines the original and enhanced procedure for changing the AX-9575 controller boards for use with one external secondary hard drive. For proper alignment of the controller board a 4MHZ square wave is fed into the data input of the WD-1100 to adjust the DLYDATA signal and to perform the preliminary adjustment of the DRUN signal. The original modification does not allow the 4MHZ signal to be fed into the WD1100 but uses the DRD2* signal from the hard drive for these adjustments. Computers requiring this modification should be modified using the enhanced procedure. Computers in for repair with the original modification should be converted to the enhanced modification, for proper alignment of the Hard Drive Controller.

PROCEDURE:

Enhanced Modification:

ON THE COMPONENT SIDE REFER TO FIGURE 3:

1. Cut the trace going to U1 pin 6 at pin 6.

ON THE SOLDER SIDE REFER TO FIGURE 4:

2. Cut the trace going to U1 pin 11 at pin 11.
3. Jumper U1 pin 6 to the feedthrough that used to go between U1 pin 11 and J1 pin 26.
4. Jumper U1 pin 11 to the feedthrough between pins 1 and 2 of U1.
5. Cut the trace going from E3 to the feedthrough.
6. Jumper the feedthrough in step 5 to U12 pin 2.
7. Cut the trace from U12 pin 2 at the feedthrough.
8. Jumper the feedthrough in step 7 to E3 staking pin.

To allow the external secondary to boot up as drive C: it must be jumpered for drive 2. The correct cables for this option are catalog # 26-5126. These are keyed but if installed backward, permanent damage will occur to the controller.

The CPU boot ROM checksums MUST be 4600 and 4A00. The correct DOS is 2.11.02 MS-DOS and must be used with the above ROMS to work properly. Align the hard drive and controller and reformat. Run the appropriate diagnostic checks to verify that the system is working.

The modification on page one is an enhanced version of the original modification outlined below. Any units in for repair with the original modification will need to be converted to the enhanced modification.

Original Modification:

ON THE COMPONENT SIDE REFER TO FIGURE 1:

1. Cut the trace going to U12 pin 1 at the feedthrough.
2. Cut the trace going to U1 pin 6 at pin 6.

ON THE SOLDER SIDE REFER TO FIGURE 2:

3. Cut the trace going to U1 pin 11 at pin 11.
4. Jumper U1 pin 6 to the feedthrough that used to go between U1 pin 11 and J1 pin 26.
5. Jumper U1 pin 11 to the feedthrough between pins 1 and 2 of U1.
6. Cut the trace from U12 pin 2 at the feedthrough.
7. Jumper U12 pin 1 to the feedthrough just cut away from U12 pin 2.
8. Jumper U12 pin 2 to the feedthrough connected to E2.

When changing the modification from the original version to the enhanced version use the conversion modification procedure.

Conversion Modification:

ON THE SOLDER SIDE REFER TO FIGURE 2:

1. Remove the jumper from U12 pin 1 to the feedthrough. Refer to Step 7 of the original procedure and drawing.
2. Remove the jumper from U12 pin 2 to the feedthrough. Refer to Step 8 of the original procedure and drawing.
3. Jumper U12 pin 1 to the E2 staking pin. This remakes the trace cut in Step 1 of the original procedure. Refer to Step 9 of the drawing.
4. Refer to the enhanced modification on Page 1 of 6 and perform steps 5, 6, and 8.

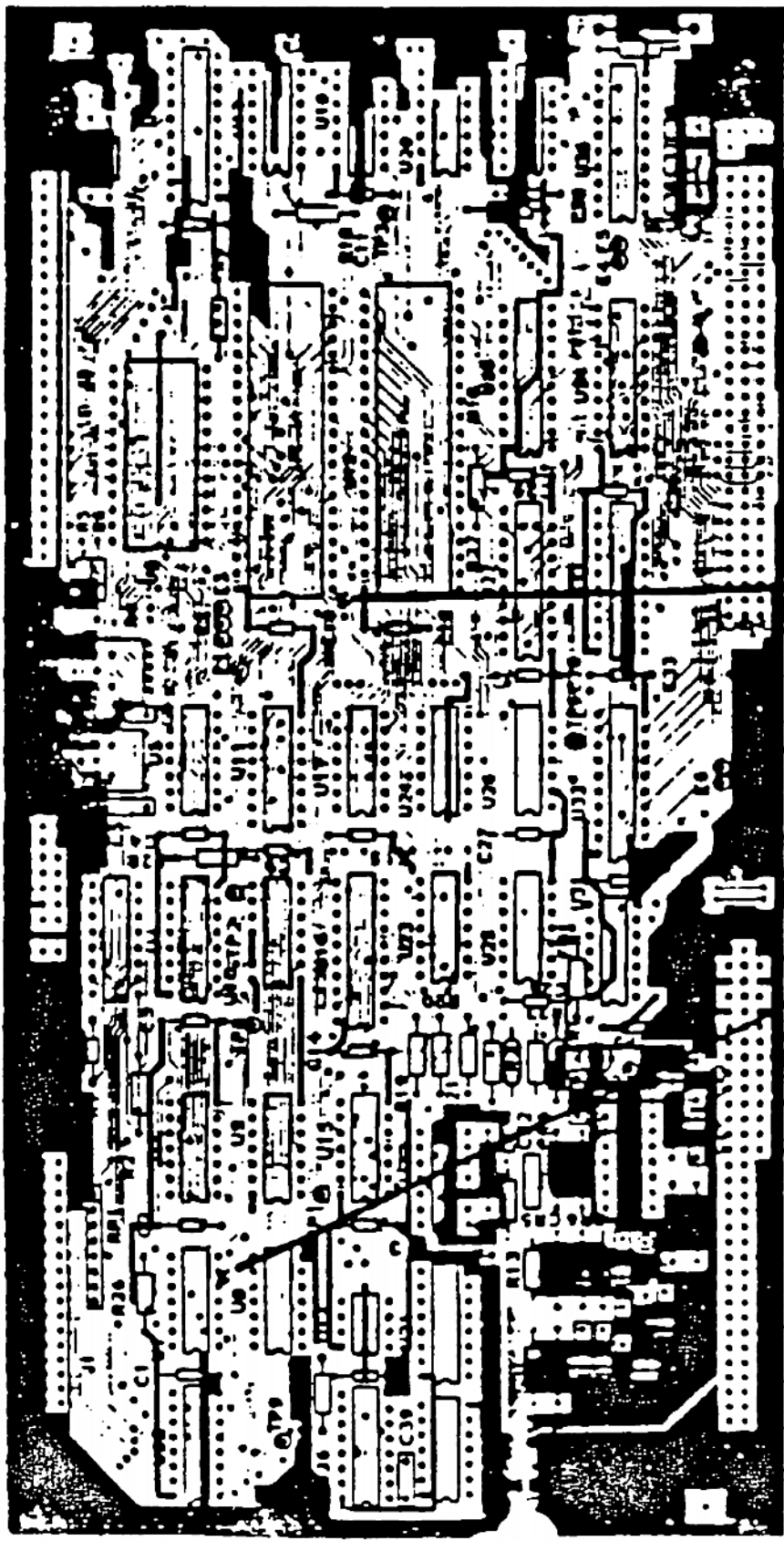

Step 2 Figure 1 Step 1

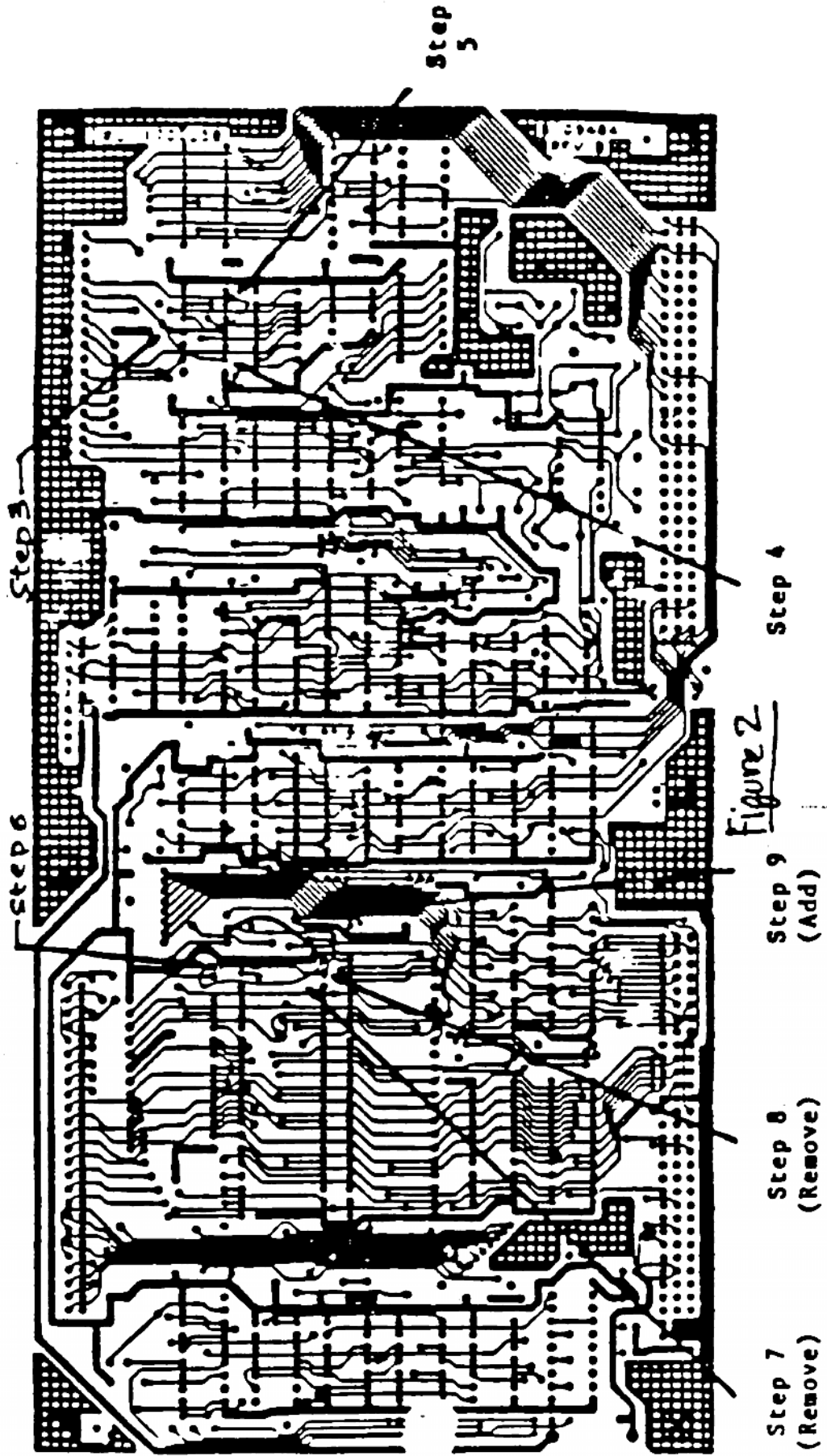

Figure 2

Step 7
(Remove)

Step 8
(Remove)

Step 9
(Add)

Step 4

Step 5

Step 3

Step 6

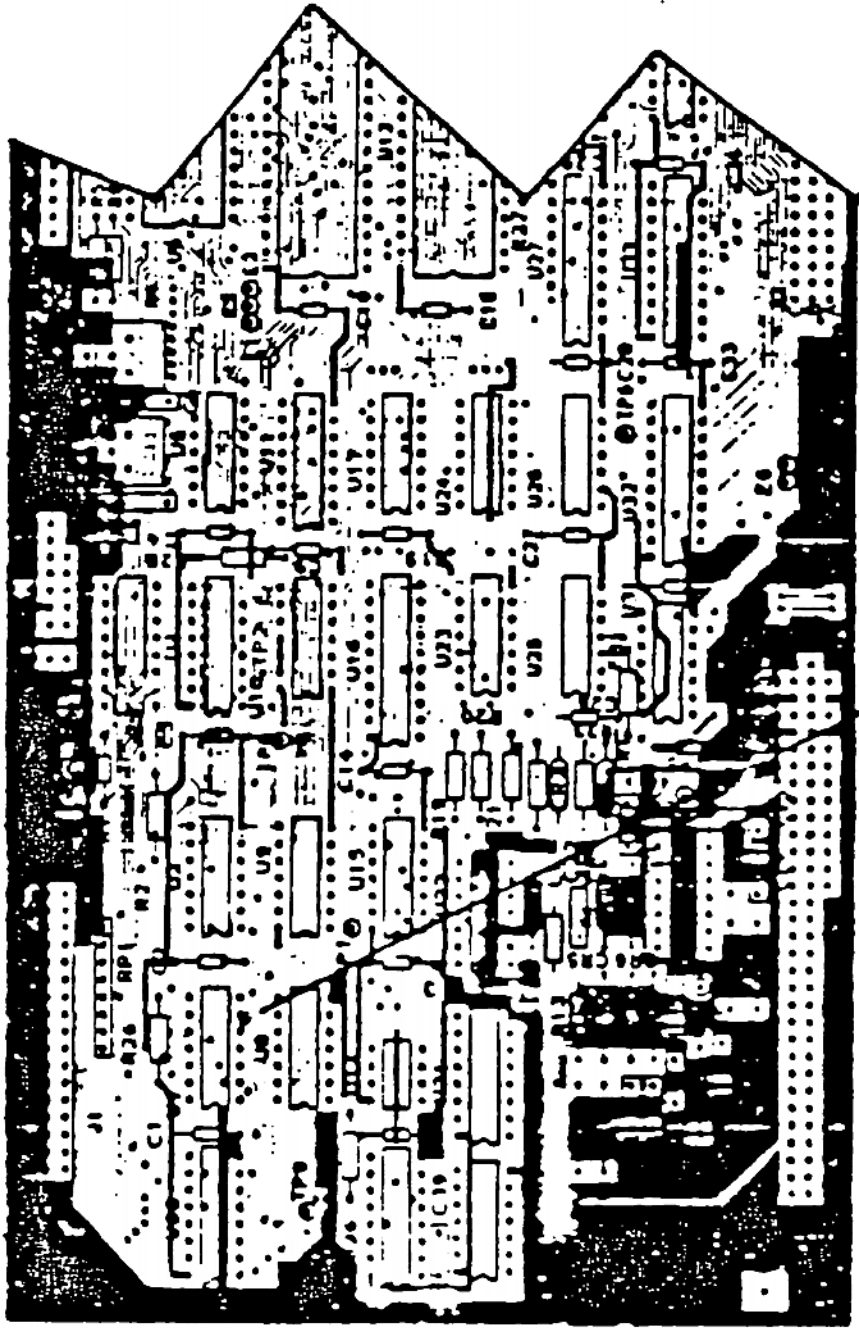

Step 1 Figure 3

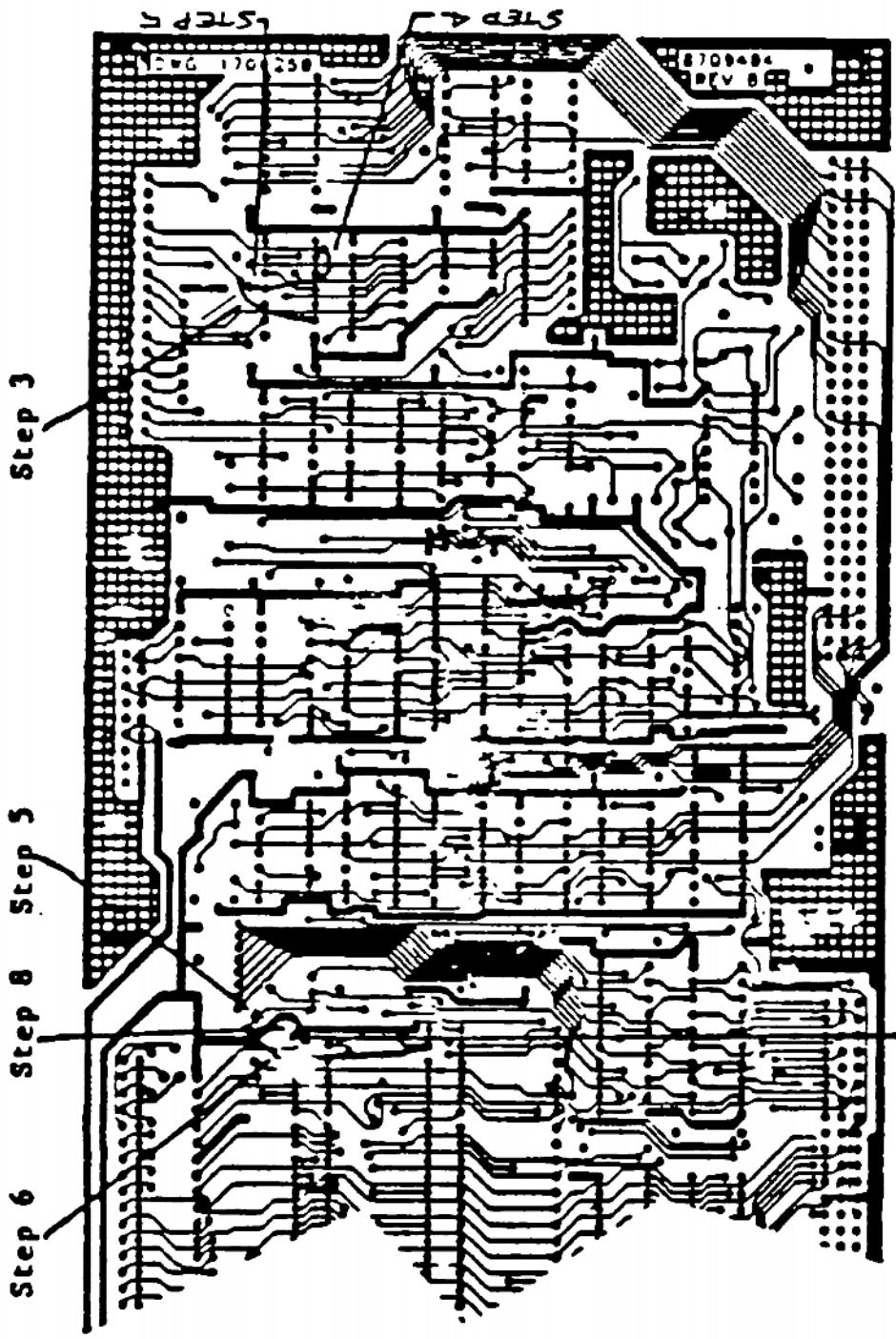

Figure 4

Step 7

DATE:

REVISION DATE:

BULLETIN NO:

PRODUCT:

SUBASSEMBLY:

SUBASSEMBLY REVISION:

PURPOSE:

DISCUSSION:

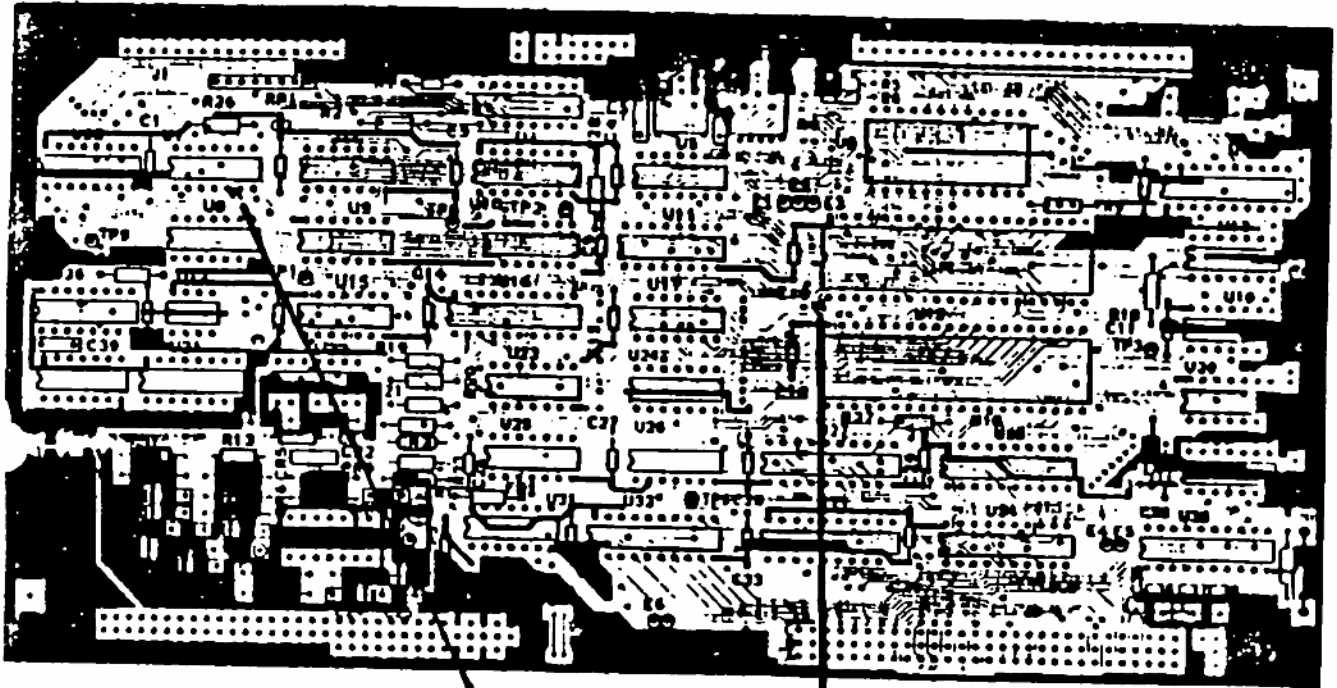

Step 2 Figure 1 Step 1

DATE:

REVISION DATE:

BULLETIN NO:

PRODUCT:

SUBASSEMBLY:

SUBASSEMBLY REVISION:

PURPOSE:

DISCUSSION:

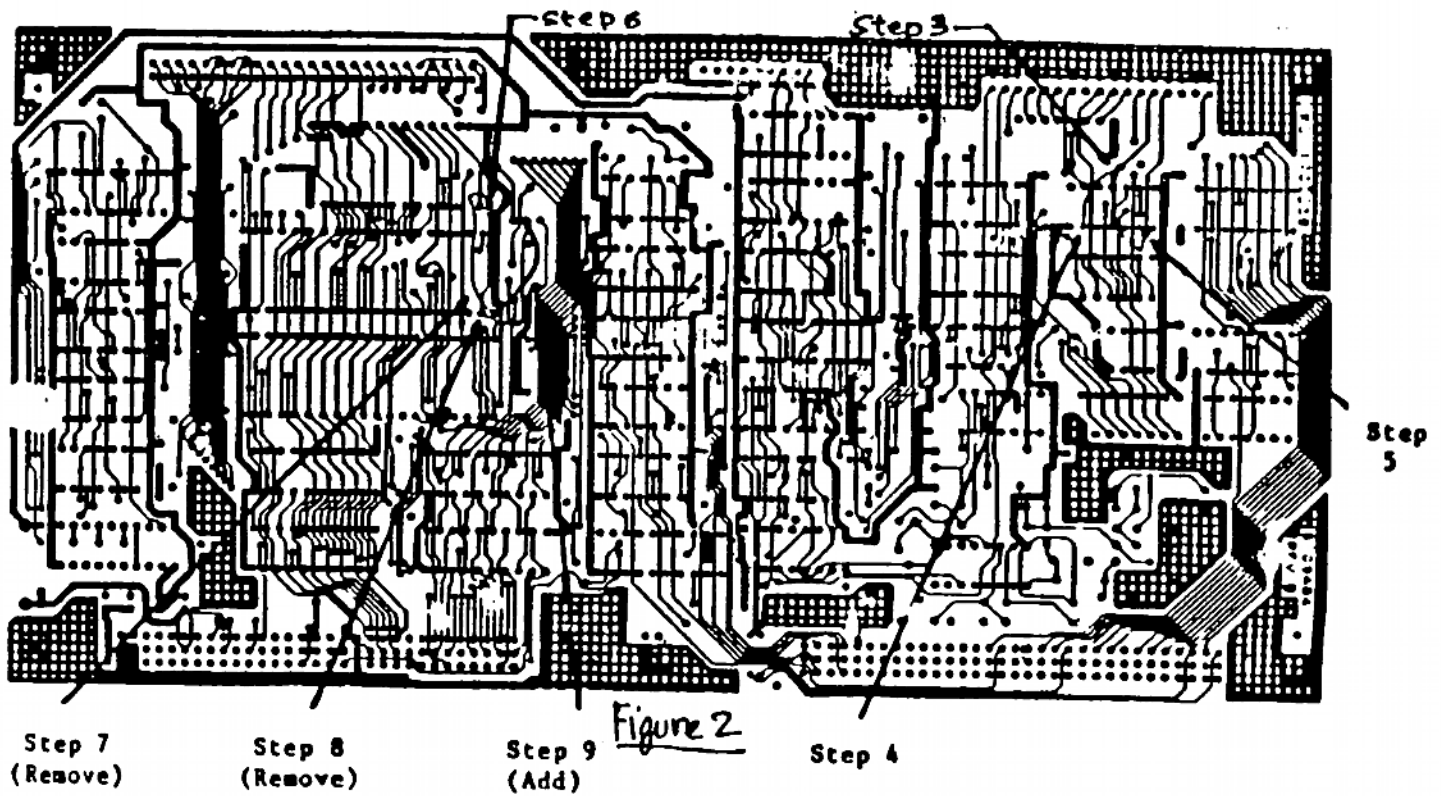

DATE:

REVISION DATE:

BULLETIN NO:

PRODUCT:

SUBASSEMBLY:

SUBASSEMBLY REVISION:

PURPOSE:

DISCUSSION:

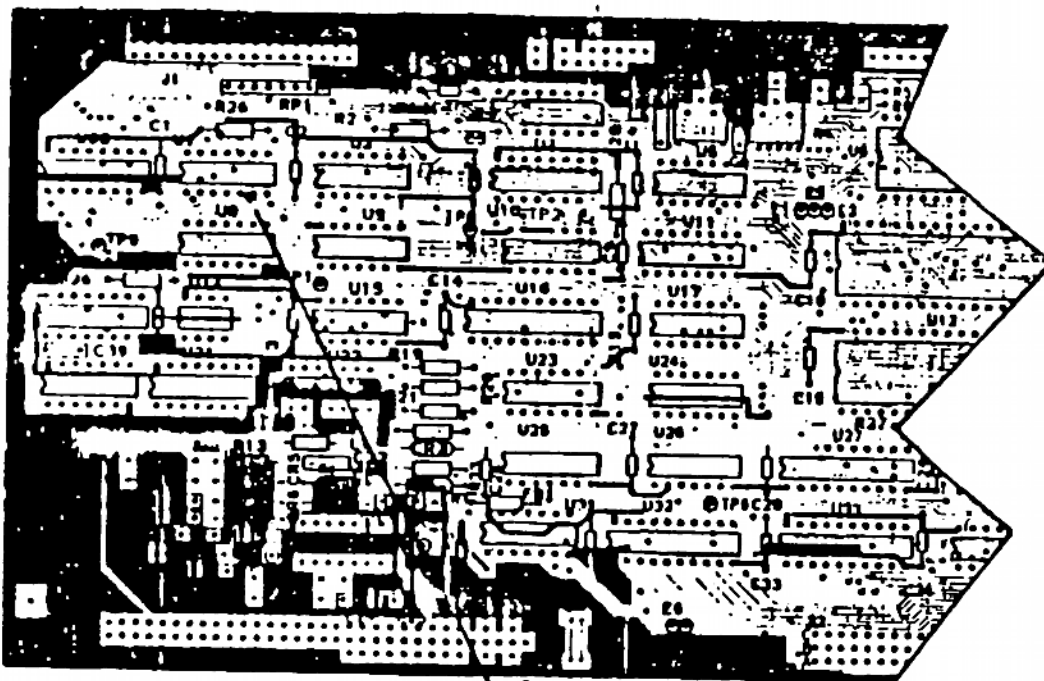

Step 1 Figure 3

DATE:

REVISION DATE:

BULLETIN NO:

PRODUCT:

SUBASSEMBLY:

SUBASSEMBLY REVISION:

PURPOSE:

DISCUSSION:

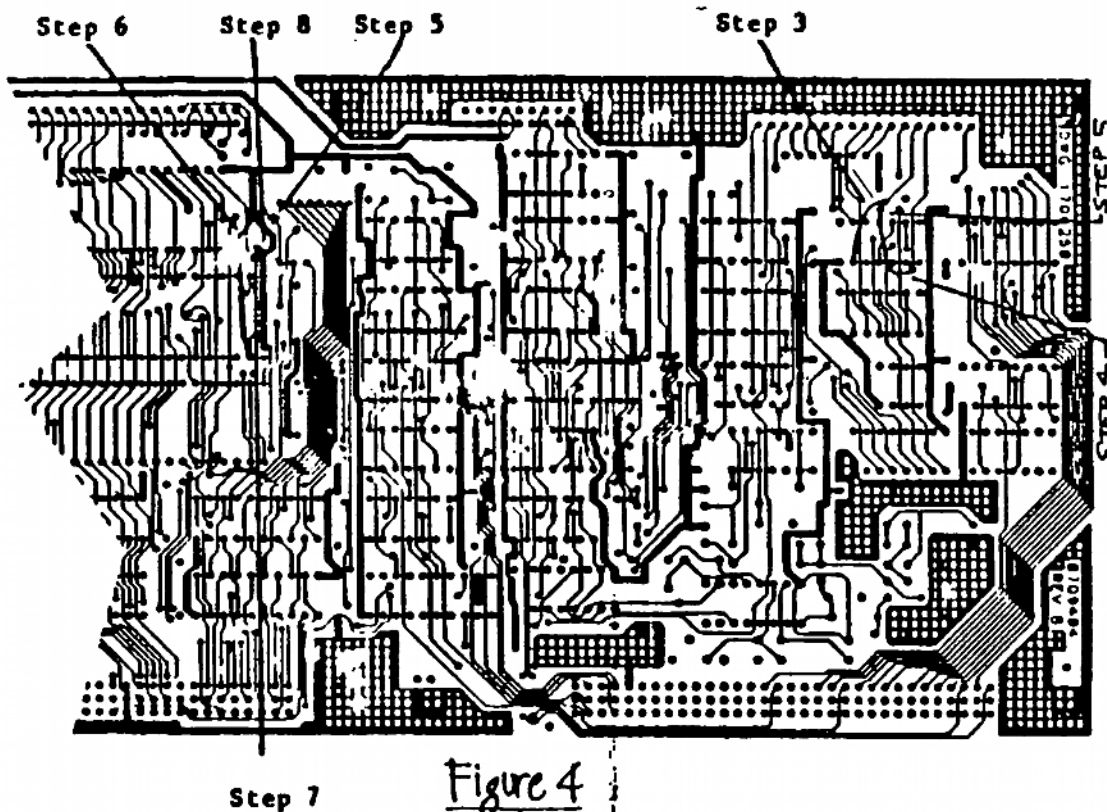

Figure 4

TANDY COMPUTER PRODUCTS

DATE: November 19, 1987
REVISION DATE: November 19, 1987
BULLETIN NO: 2000:45
PRODUCT: Tandy 2000 26-5103
SUBASSEMBLY: AX-9452 Main Logic Board
SUBASSEMBLY REVISION: ALL

PURPOSE: To enable proper Modem operation with the Tandy 2000.

DISCUSSION: The UART in the Tandy 2000 requires that CTS be asserted before transmission will be allowed. The CTS line in the Tandy 2000 has an 8.2K resistor attached to -12V. Some modems will not work with the Tandy 2000 because they either do not drive the CTS line, or they do not have sufficient current drive to overcome the 8.2K resistor. A modification to the Tandy 2000 main logic board removing the 8.2K pulldown resistor from the CTS line to -12V and installing an 8.2K pullup resistor from the CTS line to +12V will insure the CTS line is asserted when these modems are used.

PROCEDURE:

1. On the solder side of the main logic board cut the trace going from U6 pin 13 to RP2 pin 4.
2. Still on the solder side of the main logic board, solder one lead of an 8.2K ohm 1/4 watt resistor to U6 pin 13 and the other lead to U5 pin 14. Care should be taken to trim the leads so the resistor can be neatly dressed and the leads are not shorting out any trace.
3. Test the machine for proper operation with appropriate diagnostics.

TANDY COMPUTER PRODUCTS

DATE: January 11, 1988
REVISION DATE: June 1, 1988
BULLETIN NO: 2000;46
PRODUCT: 26-5161/2 Tandy 2000 External Memory Board
SUBASSEMBLY: AX-9469 External Memory PCB
SUBASSEMBLY REVISION: All

PURPOSE: To permit the use of Samsung RAM chips and reduce Parity Errors

DISCUSSION:

The external memory boards in the Tandy 2000 have been found to have excessive noise for Samsung RAM chips to function properly. Symptoms of this problem include DATA PARITY ERRORS and FAULTY READ AND WRITE to the expansion RAM. This modification must be performed if any of the RAM chips are manufactured by Samsung. Other manufacturers RAM are not adversely affected by this modification. Table 1 shows the logos used by several manufacturers.

Some of the noise is caused by U11, a multiple input OR gate that has pins 1, 2, and 3 floating. Although not used, these pins should be grounded. Another source of noise is that the rise time of the RAS0*, RAS1*, CASL*, and CASH* signals are too fast for some RAMS. The additional high frequency components of these signals will cause some RAMS to glitch and access the wrong data cell. Adding small bypass capacitors to these lines on the component side of the board will filter out the extra noise.

PROCEDURE:

1. Solder a 150 pF 50 volt 10% cap between pin 6 of RP1 and ground. The nearest ground is on C18 nearest to RP1 pin 7. This is the RAS1* signal.
2. Solder a 150 pF 50 volt 10% cap between pin 4 of RP1 and ground. The nearest ground is on C18 nearest to RP1 pin 7. This is the CASL* signal.
3. Solder a 150 pF 50 volt 10% cap between pin 3 of RP1 and ground. The nearest ground is on C12 nearest to U13 pin 5. This is the RAS0* signal.
4. Solder a 150 pF 50 volt 10% cap between pin 2 of RP1 and ground. The nearest ground is on C18 nearest to U13 pin 5. This is the CASH* signal.
5. Check for a trace from U11 pin 4 to U11 pins 1, 2, and 3. If not installed solder a jumper from U11 pin 4 to U11 pins 1, 2, and 3.

TANDY COMPUTER PRODUCTS

6. Run memory diagnostics to verify the machine is working properly.

The capacitor is a 150pF, 50 volt, 20% ceramic disk type capacitor. It is available from National Parts under:

Part#	Catalog#
CC-151KJBC	10-9999C

Logos for selected RAM manufactures.













	Fujitsu Microelectronics, Inc. ● Fujitsu Microelectronics Inc.
	Hitachi America, Ltd. ● Hitachi America, Ltd.
	Micron Technology, Inc. ● Micron Technology, Inc.
	Mitsubishi Electronics America ● Mitsubishi Electronics America
	Motorola, Inc. ● Motorola, Inc.
	NEC Electronics, Inc. ● NEC Electronics, Inc.
	OKI Semiconductor, Inc. ● OKI Semiconductor, Inc.
	Panasonic (Matsushita) ● Matsushita Electronics, Inc.
	Samsung Semiconductor, Inc. ● Samsung Semiconductor, Inc.
	Tandy Corporation ● Tandy Corporation
	Texas Instruments, Inc. ● Texas Instruments, Inc.
	Toshiba America, Inc. ● Toshiba America, Inc.

Table 1



#022 TECHNICAL SUPPORT
 DOCUMENTATION LIBRARY
 Z-11-85

SUPPLIER'S PART NO. 74181 74182 74183 74184 74185 74186 74187 74188 74189 74190 74191 74192 74193 74194 74195 74196 74197 74198 74199 74200 74201 74202 74203 74204 74205 74206 74207 74208 74209 74210 74211 74212 74213 74214 74215 74216 74217 74218 74219 74220 74221 74222 74223 74224 74225 74226 74227 74228 74229 74230 74231 74232 74233 74234 74235 74236 74237 74238 74239 74240 74241 74242 74243 74244 74245 74246 74247 74248 74249 74250 74251 74252 74253 74254 74255 74256 74257 74258 74259 74260 74261 74262 74263 74264 74265 74266 74267 74268 74269 74270 74271 74272 74273 74274 74275 74276 74277 74278 74279 74280 74281 74282 74283 74284 74285 74286 74287 74288 74289 74290 74291 74292 74293 74294 74295 74296 74297 74298 74299 74300 74301 74302 74303 74304 74305 74306 74307 74308 74309 74310 74311 74312 74313 74314 74315 74316 74317 74318 74319 74320 74321 74322 74323 74324 74325 74326 74327 74328 74329 74330 74331 74332 74333 74334 74335 74336 74337 74338 74339 74340 74341 74342 74343 74344 74345 74346 74347 74348 74349 74350 74351 74352 74353 74354 74355 74356 74357 74358 74359 74360 74361 74362 74363 74364 74365 74366 74367 74368 74369 74370 74371 74372 74373 74374 74375 74376 74377 74378 74379 74380 74381 74382 74383 74384 74385 74386 74387 74388 74389 74390 74391 74392 74393 74394 74395 74396 74397 74398 74399 74400 74401 74402 74403 74404 74405 74406 74407 74408 74409 74410 74411 74412 74413 74414 74415 74416 74417 74418 74419 74420 74421 74422 74423 74424 74425 74426 74427 74428 74429 74430 74431 74432 74433 74434 74435 74436 74437 74438 74439 74440 74441 74442 74443 74444 74445 74446 74447 74448 74449 74450 74451 74452 74453 74454 74455 74456 74457 74458 74459 74460 74461 74462 74463 74464 74465 74466 74467 74468 74469 74470 74471 74472 74473 74474 74475 74476 74477 74478 74479 74480 74481 74482 74483 74484 74485 74486 74487 74488 74489 74490 74491 74492 74493 74494 74495 74496 74497 74498 74499 74500	TANDY 800085 10 2
---	----------------------------

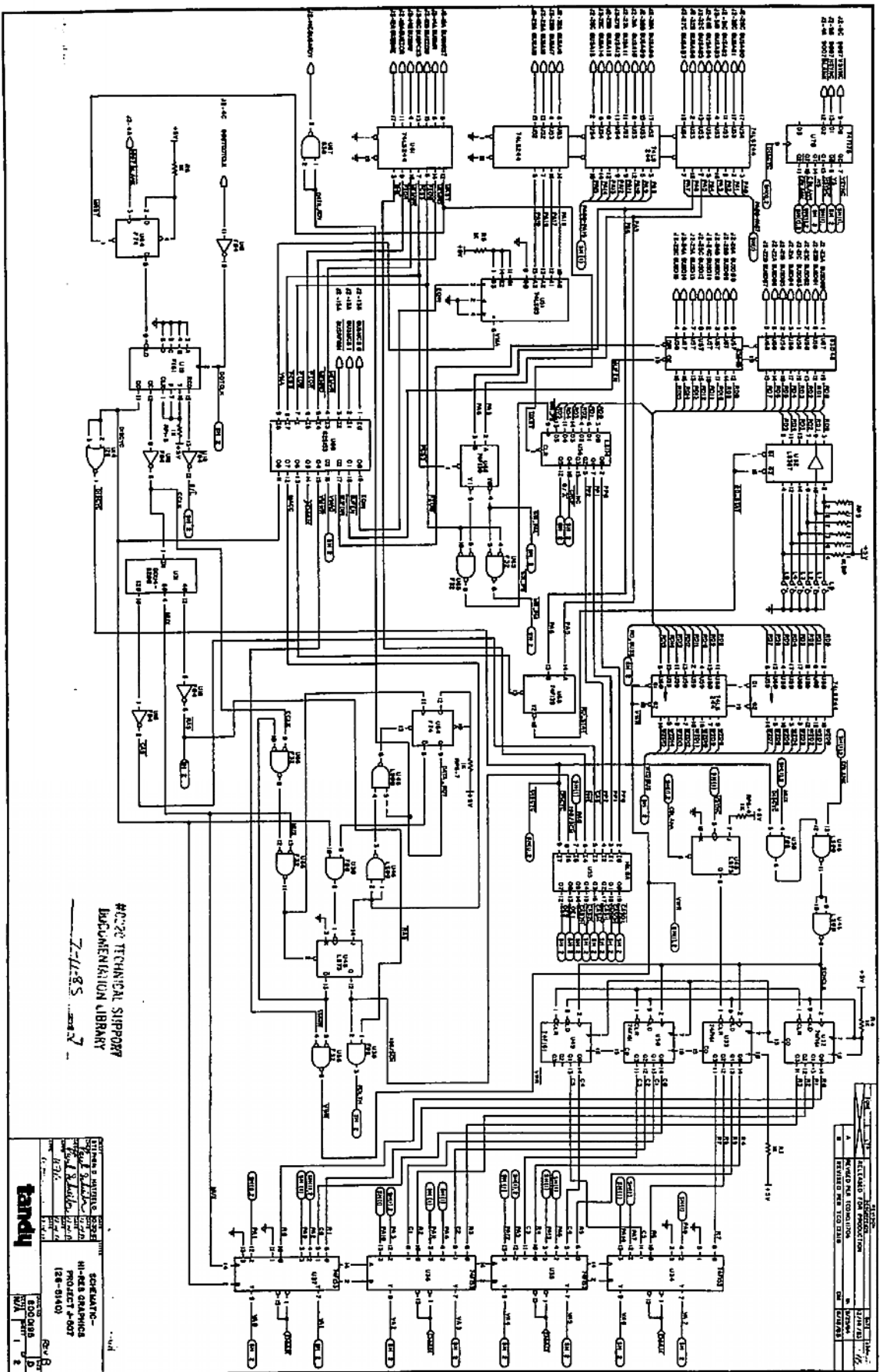
REV	DATE	BY	CHKD
1			
2			
3			
4			
5			
6			
7			
8			
9			
10			

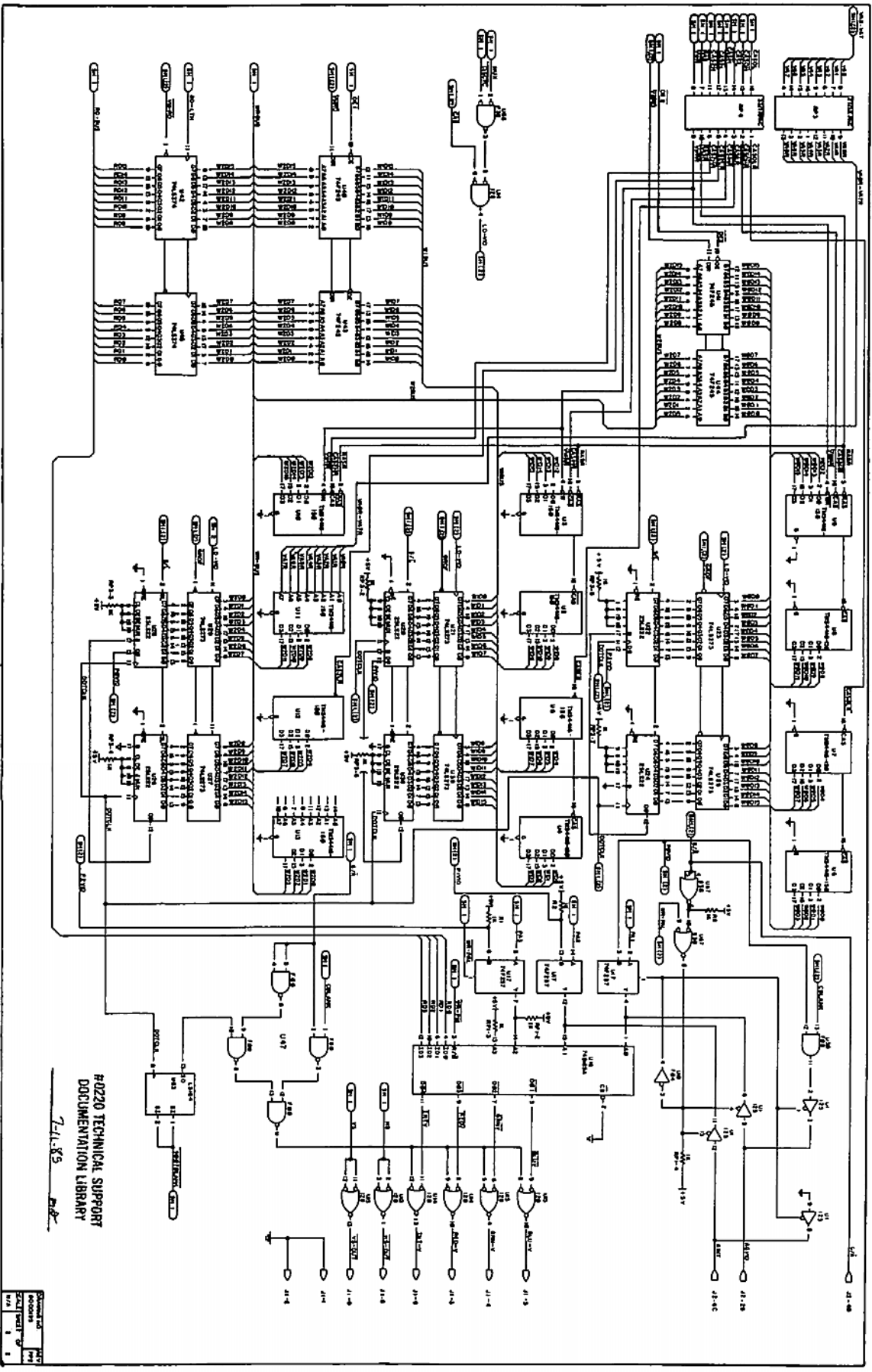

P0220 TECHNICAL SUPPORT
DOCUMENTATION LIBRARY
7/1/85

Doc No.	P0220
Rev.	1
Date	7/1/85

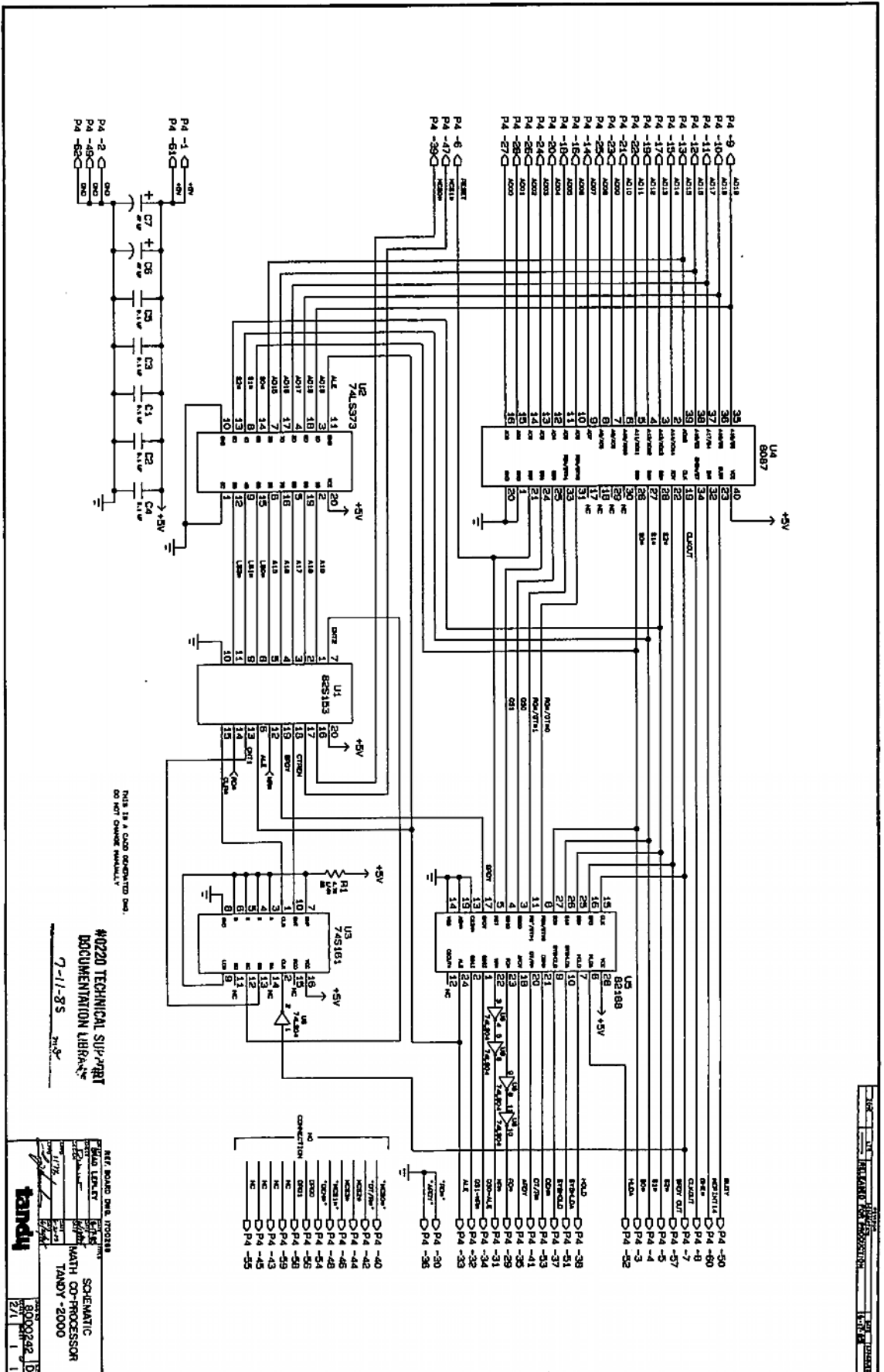

THIS IS A COPY GENERATED BY
DO NOT CHANGE MANUALLY

#0220 TECHNICAL SUPPORT
DOCUMENTATION LIBRARY
7-11-85

REF BOARD DATA PROCESSOR

BOARD LIBRARY	STATUS
DATE	REVISION
BY	DATE
NAME	DATE
PROJECT	DATE
DESCRIPTION	DATE
TANDY	DATE

SCHEMATIC
MATH CO-PROCESSOR
TANDY-2000

8000242
E71