



TeleVideo[®] TS 1605 User's Manual

TELEVIDEO

TS 1605 COMPUTER SYSTEM

USER'S MANUAL

TeleVideo Part Number 123180-00 Rev. B

15 January 1984

Copyright (c) 1983 by TeleVideo Systems, Inc. All rights reserved. No part of this publication may be reproduced, transmitted, transcribed, stored in a retrieval system, or translated into any language or computer language, in any form or by any means, electronic, mechanical, magnetic, optical, chemical, manual, or otherwise, without the prior written permission of TeleVideo Systems, Inc., 1170 Morse Avenue, P.O. Box 3568, Sunnyvale, California 94088.

Disclaimer

TeleVideo Systems, Inc. makes no representations or warranties with respect to this manual. Further, TeleVideo Systems, Inc. reserves the right to make changes in the specifications of the product described within this manual at any time without notice and without obligation of TeleVideo Systems, Inc. to notify any person of such revision or changes.

WARNING

This equipment generates, uses, and can radiate radio frequency energy, and if not installed and used in accordance with the instruction manual may cause interference to radio communications. It has been tested and found to comply with the limits for a Class A computing device pursuant to Subpart J of Part 15 of FCC Rules, which are designed to provide reasonable protection against such interference when operated in a commercial environment and when peripherals are connected to the I/O ports with shielded I/O cables giving it 100% shielding at all applicable frequencies up to 1000MHz. A peripheral must meet the FCC Regulations when connected to this product. This is the responsibility of the peripheral manufacturer. Operation of this equipment in a residential area is likely to cause interference, in which case the user at his own expense will be required to correct the interference.

TeleVideo is a registered trademark of TeleVideo Systems, Inc.
TeleDOS is a trademark of TeleVideo Systems, Inc.
IBM is a registered trademark of International Business Machines
MS -DOS is trademark of MicroSoft Corporation

TeleVideo Systems, Inc., 1170 Morse Avenue, P.O. Box 3568,
Sunnyvale, Ca 94086, 408/745-7760

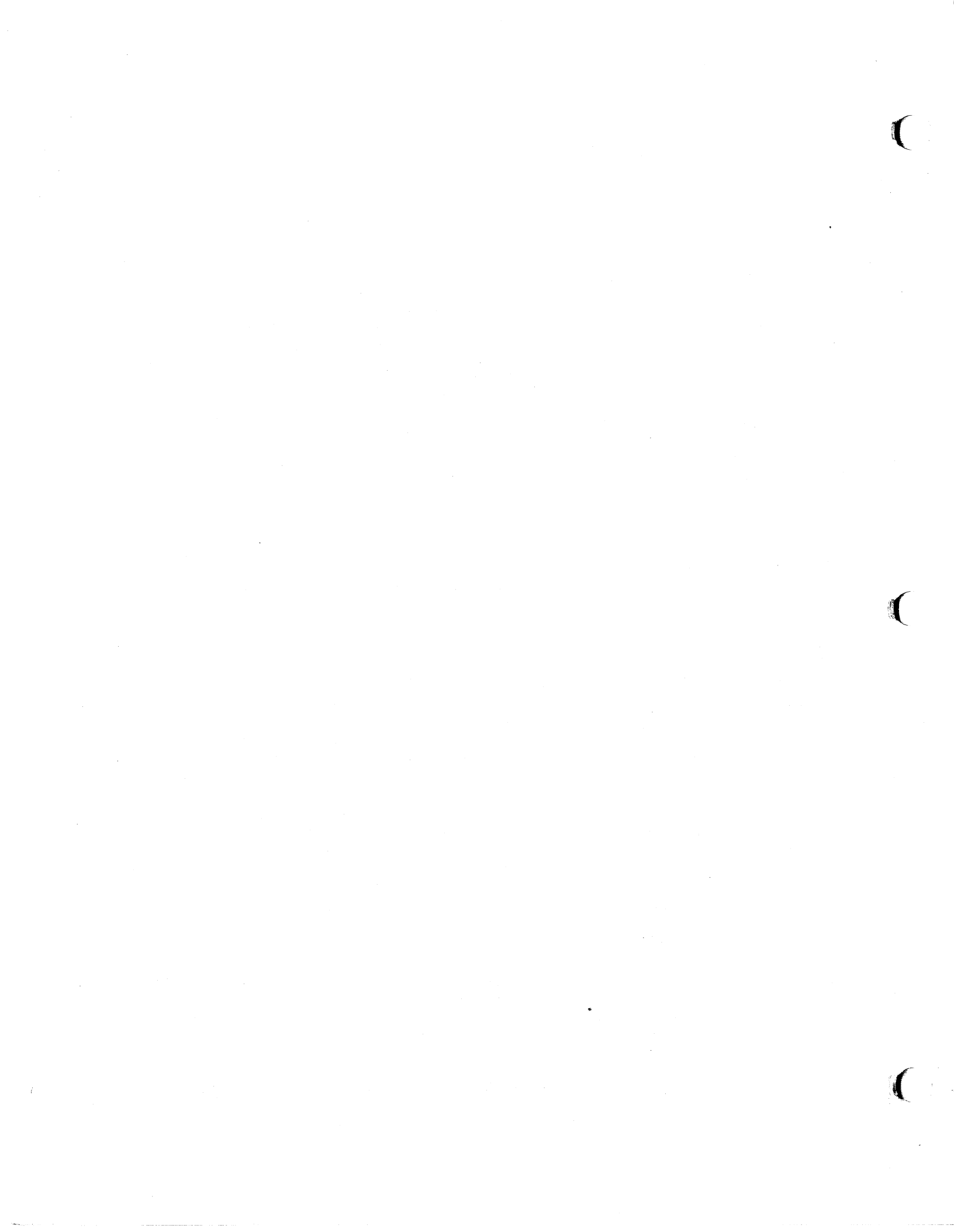

STATEMENT OF LIMITED WARRANTY

TeleVideo Systems, Inc. ("TeleVideo") warrants to Buyer that its products, except software, will be free from defects in materials and workmanship for 90 calendar days after date of sale. TeleVideo's obligations under this warranty will be limited to repairing or replacing, at TeleVideo's option, the part or parts of the products which prove defective in material or workmanship, provided that the Buyer gives TeleVideo prompt notice of any defect and satisfactory proof thereof.

If service is required under this warranty, Buyer must return the product to an Authorized TeleVideo Dealer or the original Dealer from which the unit was purchased. With respect to any product or part thereof not manufactured by TeleVideo, only the warranty, if any, given by the manufacturer thereof, will apply.

EXCLUSIONS

This limited warranty does not cover losses or damage which occurs in shipment to or from Buyer, or is due to (1) improper installation or maintenance, misuse, neglect or any cause other than ordinary commercial or industrial application or (2) adjustment, repair or modification by other than TeleVideo authorized personnel or (3) improper environment, excessive or inadequate heating or air conditioning and electrical power failures, surges or other irregularities or (4) any statements made about TeleVideo's products by salesman, dealers, distributors or agents, unless confirmed in writing by a TeleVideo officer.

THE FOREGOING TELEVIDEO LIMITED WARRANTY IS IN LIEU OF ALL OTHER WARRANTIES, WHETHER ORAL, WRITTEN, EXPRESS, IMPLIED OR STATUTORY. IMPLIED WARRANTIES OF MERCHANTABILITY AND FITNESS FOR A PARTICULAR PURPOSE DO NOT APPLY. TELEVIDEO'S WARRANTY OBLIGATIONS AND BUYER'S REMEDIES HEREUNDER ARE SOLELY AND EXCLUSIVELY AS STATED HEREIN. TELEVIDEO MAKES NO WARRANTY WHATSOEVER CONCERNING ANY SOFTWARE PRODUCTS, WHICH ARE SOLD "AS IS" AND "WITH ALL FAULTS". TELEVIDEO'S LIABILITY, WHETHER BASED ON CONTRACT, TORT, WARRANTY, STRICT LIABILITY OR ANY OTHER THEORY, SHALL NOT EXCEED THE PRICE OF THE INDIVIDUAL UNIT WHOSE DEFECT OR DAMAGE IS THE BASIS OF THE CLAIM. IN NO EVENT SHALL TELEVIDEO BE LIABLE FOR ANY LOSS OF PROFITS, LOSS OF USE OF FACILITIES OR EQUIPMENT, OR OTHER INDIRECT, INCIDENTAL OR CONSEQUENTIAL DAMAGES.

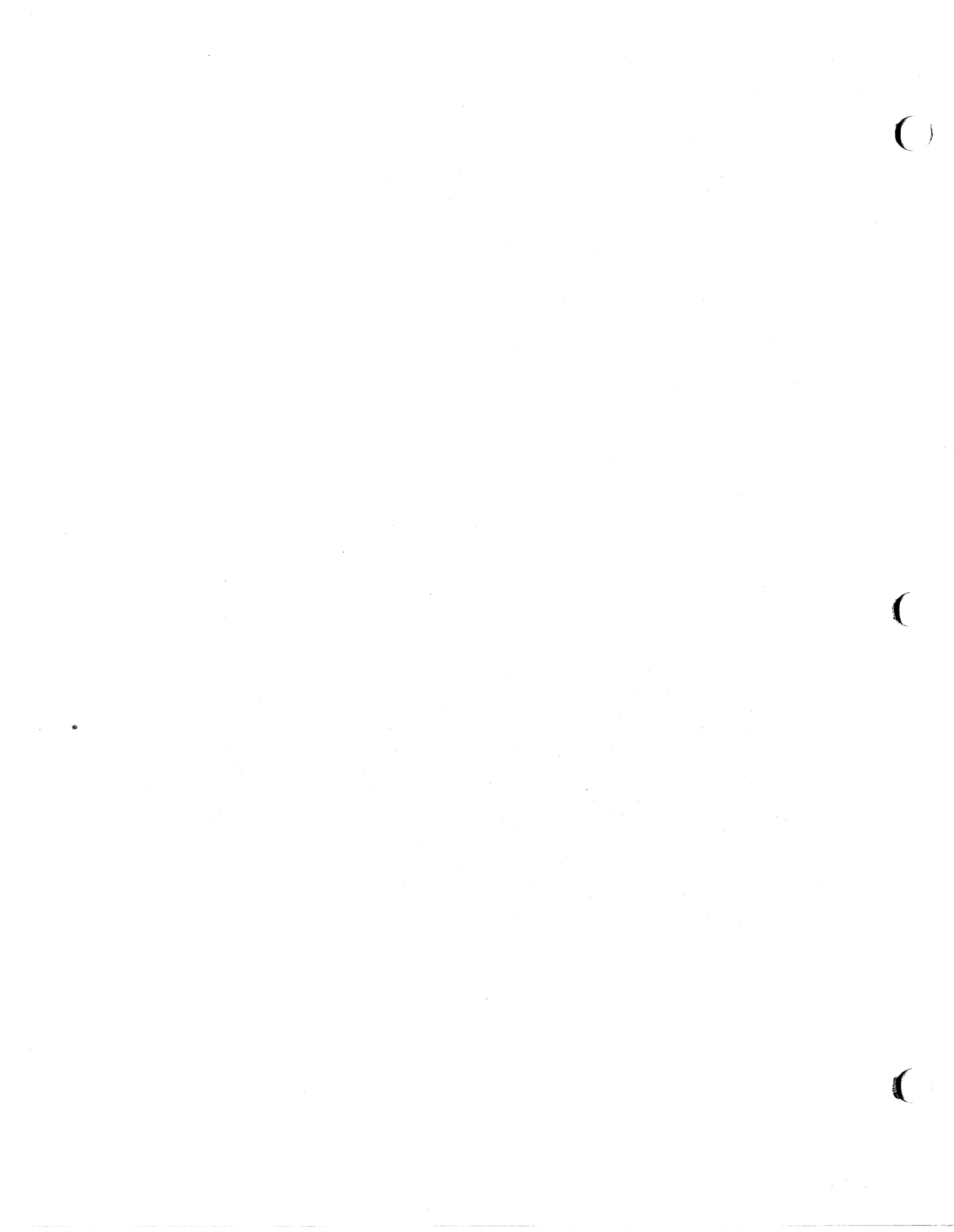

TABLE OF CONTENTS

1.	INTRODUCTION	1.1
	Features	1.2
	User's Manual Format	1.2
	Special Notes	1.2
	Notation Conventions	1.3
	Additional Manuals	1.3
2.	SETUP	2.1
	Selecting the Right Location	2.1
	Environment	2.1
	Setting Up Your Computer	2.2
	Peripherals	2.5
3.	OPERATION	3.1
	Power On	3.1
	Adjusting the Contrast	3.2
	Operating System	3.3
	Turning the Computer Off	3.4
4.	THE KEYBOARD	4.1
	The Main Keyboard	4.1
	Numeric Keypad	4.3
	Function Keys	4.5
	Special Key Combinations	4.6
5.	RUNNING APPLICATIONS PROGRAMS	5.1
6.	WORKING WITH DISKETTES	6.1
	Handling and Storing Diskettes	6.2
	Formatting Diskettes	6.4
	Backing Up Diskettes	6.4
	Copying Master Diskettes	6.4
	Write-Protecting Diskettes	6.4

TS 1605 User's Manual

7.	CONNECTING PERIPHERALS	7.1
	Attaching Cables	7.1
	Parallel Printers	7.2
	Modems	7.2
8.	INSTALLING OPTION BOARDS	8.1
9.	CARING FOR THE TS 1605	9.1
	Care	9.1
	Inspection	9.1
	Service	9.1
	Service During Warranty	9.2
	On-Site Service After Warranty	9.2
	Shipping the TS 1605	9.2
10.	MAINTENANCE	10.1
	Troubleshooting	10.1
	Changing the Fuse	10.2

APPENDICES

A.	Specifications
B.	Suggested References
C.	Buying Additional Diskettes
D.	Changing the Voltage Switch to 230 Volts
E.	Connector Pin Assignments
F.	Rear Panel Switch Settings
G.	Color Monitor Connectors
H.	Tips for Using Option Boards with Asynchronous Communications

LIST OF FIGURES

1-1	The TS 1605.	1.1
2-1	Example Work Space	2.1
2-2	Keyboard Connection	2.2
2-3	Rear Panel Switch	2.3
2-4	Power Switch	2.3
2-5	Power Cord Connection	2.4
2-6	Screen Positioning Knob	2.5
3-1	Power Switch	3.1
3-2	Contrast Knob	3.2
3-3	Inserting a Diskette	3.3
4-1	The Keyboard	4.1
4-2	Main Keyboard Area	4.2
4-3	Numeric Keypad	4.3
4-4	Function Keys	4.6
6-1	Floppy Diskette	6.1
6-2	Diskette Inside Permanent Plastic Enclosure	6.1
7-1	D-Shaped Cable Connector	7.1
7-2	Correctly-Folded Excess Ribbon Cable	7.2
8-1	Location of Case Screws	8.1
8-2	Removing the Side Case	8.2
8-3	Disconnecting the Disk Drive Cables	8.3
8-4	Rear Shroud Connector Cover	8.4
8-5	System Board	8.4
8-6	Attaching the Top Bracket to the Option Board	8.5
8-7	Attaching the Edge Connector Bracket	8.6
8-8	Positioning the Option Board	8.6
10-1	Exterior Fuse Location	10.3
10-2	Good Fuse	10.3
10-3	Blown Fuse	10.3
D-1	Fuse	D.1
D-2	Voltage Switch	D.2

LIST OF TABLES

1-1	Notation Conventions	1.3
4-1	Main Keyboard Special Keys	4.2
4-2	Numeric Keypad Intended Functions	4.4
4-3	Special Key Combinations	4.6
10-1	Troubleshooting Procedures	10.1
D-1	Fuse Table	D.1
E-1	Parallel Printer Port	E.1
E-2	RS-232C Serial Port	E.1
F-1	Rear Panel Switch Settings	F.1
G-1	Composite Color Monitor Connector	G.1
G-2	RGB Color Monitor Connector	G.1

1. INTRODUCTION

Welcome to the TeleVideo world of personal computers! Your new computer is designed to meet a wide variety of needs from word processing, accounting, and data base management to allowing you to write your own software programs.

Figure 1-1
The TS 1605

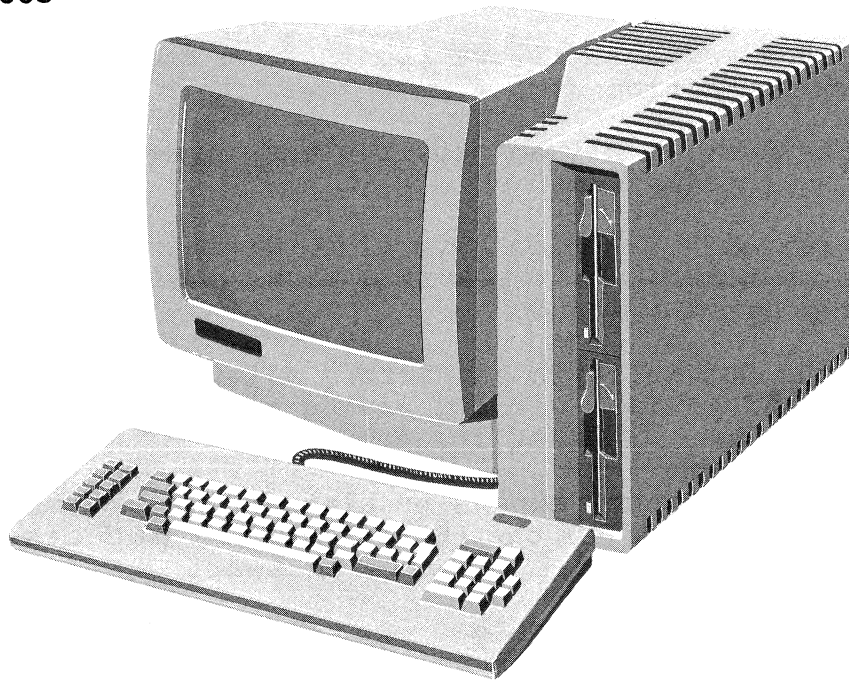

You don't need to be an electronics engineer to set up your computer! This User's Manual provides an easy step-by-step procedure for setting up and turning on your TS 1605 computer system.

Please take the time to read the installation instructions and familiarize yourself with the operation of your computer.

FEATURES

Your new TS 1605 computer is versatile, easy to use, and provides many paths for future growth. Below is a partial list of the benefits from its many design features.

- * The TS 1605 is IBM Personal Computer (IBM PC) compatible, allowing you to use over 1300 software programs written for the IBM PC
- * The adjustable green display screen is easy on the eyes
- * The cooling tower design eliminates the need for a noisy fan
- * The detached keyboard allows you to move the keyboard to a comfortable position
- * A separate numeric keypad provides easy numeric entry in accounting applications
- * Ten programmable function keys allow programs to use the function keys to perform specific tasks and/or allow easy entry of program commands
- * The TS 1605 has built-in connectors allowing you to connect a printer and a modem without having to buy additional computer hardware (except for cables)
- * A built-in IBM-format expansion slot allows you to add an option board built for the IBM into the TS 1605 case without having to buy additional computer hardware
- * An optional 1605N card allows you to connect the TS 1605 to any of TeleVideo's network or multi-user systems

USER'S MANUAL FORMAT

Several conventions are used throughout this manual. Special notes are used to draw your attention to important information. Special symbols are used to represent particular keys in various instructions.

Special Notes

Two types of notes call attention to information of special importance:

NOTE! General note emphasizing important information.

STOP! Note giving information concerning possible damage to the computer system or possible loss of data. **When you see these, STOP and read the note before proceeding.**

Notation Conventions

The symbols in Table 1-1 are used throughout the manual to describe keys you are to press.

Table 1-1
Notation Conventions

Symbol	Description
<XXX>	A word or abbreviation within these symbols (<>) indicates a key on the keyboard.
<CR>	The carriage return symbol indicates that you are to press the <ENTER> key. The <ENTER> key is marked with an angled left arrow and located on the right side of the keyboard (where the return key would be on a typewriter) above the <PRTSC> key.
/	This symbol, when used between two or more keys, indicates that you are to press the keys simultaneously. For example, <CTRL>/<BREAK> indicates you are to press the <CTRL> and <BREAK> keys at the same time.

ADDITIONAL MANUALS

TeleVideo also makes available a Technical Reference Manual for the TS 1605. This manual provides a description of the computer hardware and programming information for the system level programmer.



2. SETUP

Your TS 1605 was tested and inspected at the TeleVideo factory before it was packed for shipment. Inspect it carefully for possible shipping damage. Make sure you have received all the items checked on the packing list.

After identifying the parts of your computer, follow the directions outlined in this chapter to set it up. This includes finding a suitable location, checking and attaching the components, checking the switch settings, and determining the power requirements.

SELECTING THE RIGHT LOCATION

Select a sturdy, level surface. Leave at least four inches of free space around the computer for proper air flow.

Figure 2-1
Example Work Space

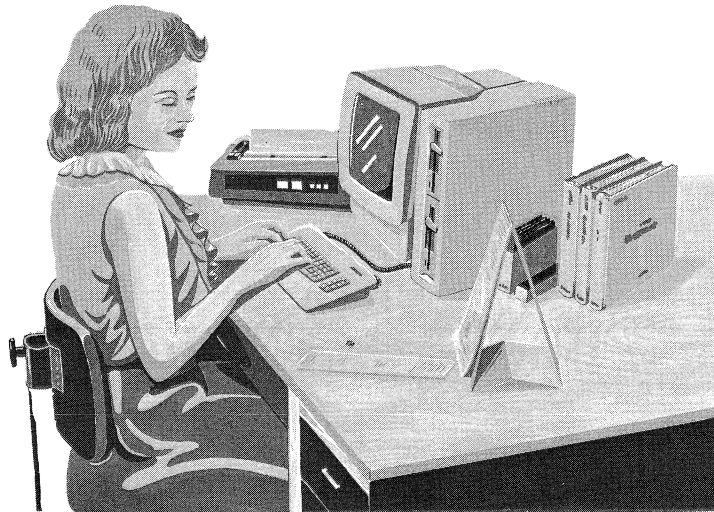

Environment

The TS 1605 operates best at temperatures and humidity levels in which you are also comfortable. Sudden and drastic temperature changes may adversely affect your stored data.

Computers require a clean environment--free of contaminants such as dust, smoke, and carpet fuzz. Excessive moisture or oil particles in the air can hinder the performance. Keep your computer away from the floor where dust or carpet fuzz would be more likely to get into the floppy disk drives.

Locate your computer at least five feet from other computing equipment, electrical appliances, or equipment such as elevators, radio transmitters, or telephones, that generate magnetic fields.

SETTING UP YOUR COMPUTER

After selecting a good location, you are ready to set up your TS 1605.

1. Place the keyboard in front of the computer. Plug the telephone-type coiled cable that is connected to the front of the computer into the phone jack outlet on the back of the keyboard as illustrated in Figure 2-2.

Figure 2-2
Keyboard Connection

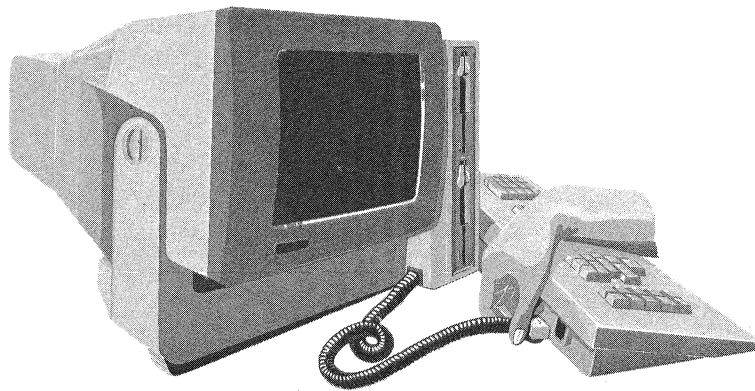

2. Check the section settings on the switch labeled **SW** on the back panel of the computer. The switch should be set as shown in Figure 2-3.

NOTE! If the switch settings do not match Figure 2-3, refer to Appendix F for information on changing the settings.

Figure 2-3
Rear Panel Switch

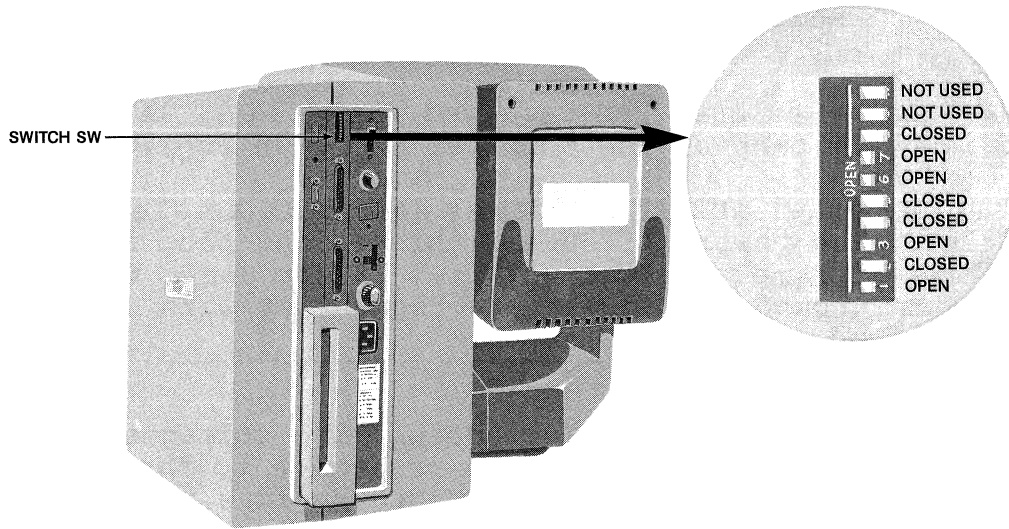

3. Locate the ON/OFF power switch on the rear panel of the computer (see Figure 2-4). Make sure the power switch is in the OFF position by pressing the plain end of the switch.

Figure 2-4
Power Switch

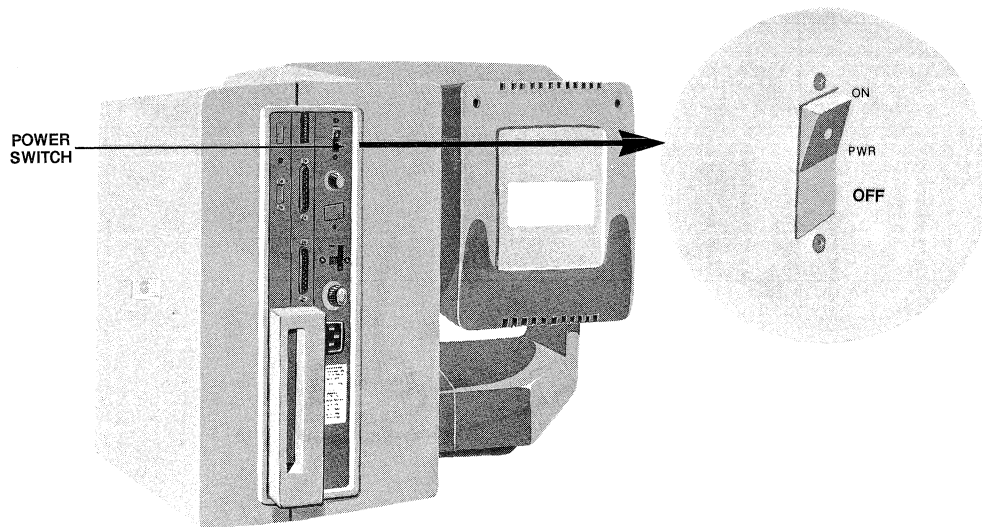

STOP! If you are using the TS 1605 on the 230 volt international power standard, refer to Appendix D to change the voltage setting and fuse from 115 VAC to 230 VAC before proceeding to the following sections.

4. Take the power cord you received with the TS 1605 and plug it into the back of the computer as shown in Figure 2-5.

Plug the other end of the power cord into an electrical outlet. The power cord has a three-prong plug and requires a three-prong electrical outlet. If you use a two-prong adapter, ground the adapter to the outlet with a pigtail as illustrated in Figure 2-5.

STOP! Incorrect or fluctuating line voltages can cause diskette data errors or damage to the system. If you have any doubt about the line voltage at your location, talk to your computer store representative.

Figure 2-5
Power Cord Connection

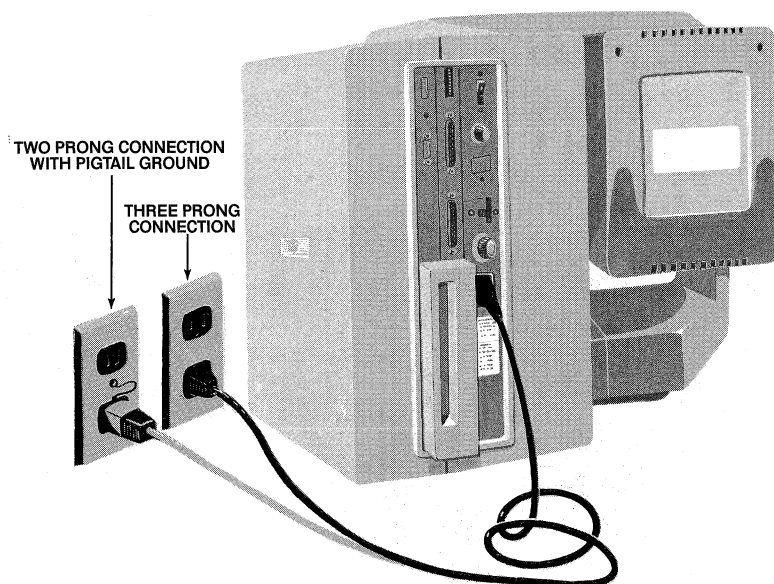

5. Position the display screen by tilting it up or down. Use the flat knob on the left side of the computer to tighten the screen into position as illustrated in Figure 2-6.

Figure 2-6
Screen Positioning Knob

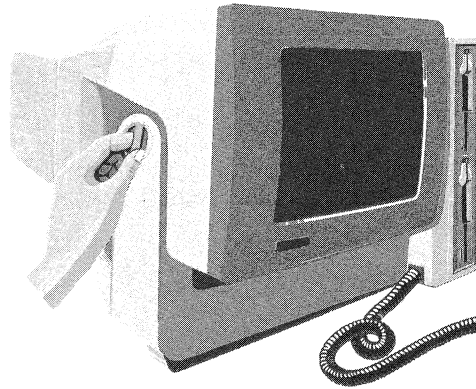

PERIPHERALS

Your TS 1605 computer has built-in connectors ready to connect to **peripherals** such as a parallel printer or a modem. Chapter 7 includes information about how to connect peripherals to the TS 1605.

C

C

C

3. OPERATION

This chapter provides a step-by-step guide for turning your computer on and loading the operating system into memory. The operating system is a group of programs that control the operation of the TS 1605.

POWER ON

Now that your computer is set up correctly as described in Chapter 2, you are ready to turn your computer on.

1. Turn the disk drive latches to the vertical position and remove the shipping cardboard. Save the cardboard inserts for possible reshipping.
2. Turn on your computer by locating the power switch on the back of the computer (see Figure 3-1) and pressing the end of the power switch that has the white dot.

Figure 3-1
Power Switch

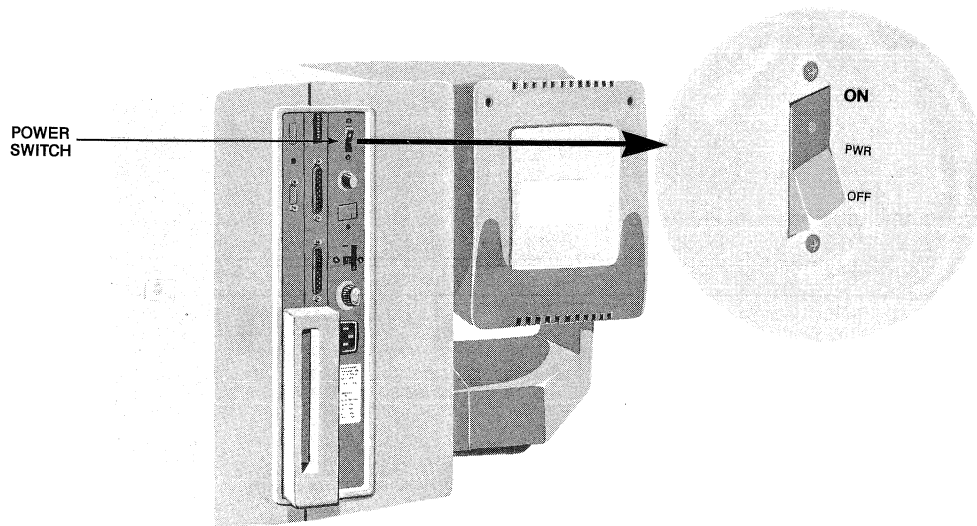

3. Listen for a beep after five to ten seconds. The beep indicates that the power is on and the computer has performed a set of self-tests. If a failure is detected during the self-test, an error message will be displayed on the screen listing the hardware subsystem that failed.

Upon successful completion of the self-test, the following message appears at the top of the screen within 20 to 30 seconds:

Disk error or non-system disk
Hit any key to retry

This message indicates that the TS 1605 did not find an operating system diskette in the upper disk drive (drive A). This message is expected, since you have not inserted an operating system diskette into the disk drive.

NOTE! If the above message does not appear, or an error message appears, turn the computer off, wait a moment, and then turn it back on. If the message does not appear, or an error message appears again, call your computer store.

Adjusting the Contrast

If the characters on the screen appear faint and hard to read, adjust the contrast by turning the contrast knob on the rear panel of the computer. Figure 3-2 shows the location of the contrast knob.

Figure 3-2
Contrast Knob

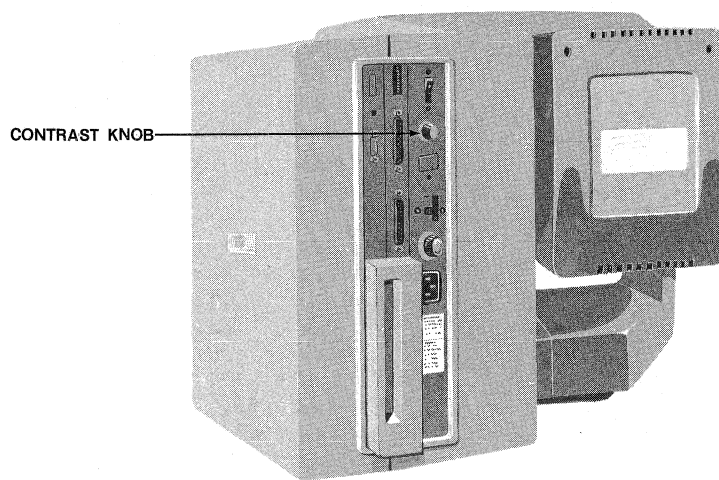

OPERATING SYSTEM

An operating system is a group of programs that control all the basic functions of the computer, including supervising the use of applications programs. TeleVideo sells the TeleDOS operating system for use with the TS 1605. TeleDOS is based on the MS-DOS operating system.

The operating system must be entered (loaded) into the computer from a diskette before software programs can be run. The following steps tell you how to load the operating system into the TS 1605 memory after you turn the computer on.

1. Remove the operating system diskette from its paper dust jacket.
2. Insert the operating system diskette into drive A (the top disk drive) with the labeled side facing to the left. Push it in gently. If the diskette seems to catch on an edge, pull it back out slightly and push it gently in again. Move the drive latch to the horizontal position and press the <SPACE BAR>.

Figure 3-3
Inserting a Diskette

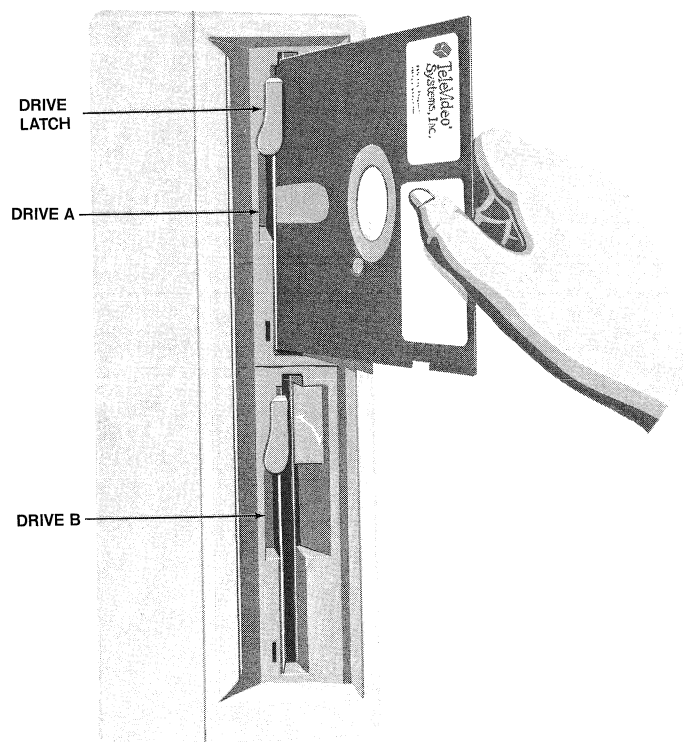

3. The TS 1605 loads the operating system from the diskette into memory. To use the operating system, follow the instructions in the operating system user's manual. The instructions for starting TeleDOS can be found in Chapter 2 of the TeleDOS User's Manual.

TURNING THE COMPUTER OFF

The following procedures should always be followed when turning the TS 1605 off.

1. Turn the drive latches to the vertical position.
2. Remove any diskettes from the disk drives.
3. Turn off the power by pressing the plain end of the power switch.

STOP! **ALWAYS TURN THE LATCHES ON THE DISK DRIVES TO THE VERTICAL POSITION BEFORE TURNING THE POWER TO THE COMPUTER ON OR OFF.** When power is turned ON or OFF there may be a momentary surge of power through some of the system's circuits. Turning the drive latches to the vertical position at power-on or power-off positions the disk drive heads away from the diskette, preventing accidental erasures.

4. THE KEYBOARD

The TS 1605 keyboard is divided into three sections: the **main keyboard**, the **numeric keypad**, and the **function keys**. The main keyboard looks very similar to a typewriter, with the addition of some keys that perform special computer functions. The numeric keypad provides easy numeric data entry while using accounting applications programs.

Figure 4-1
The Keyboard

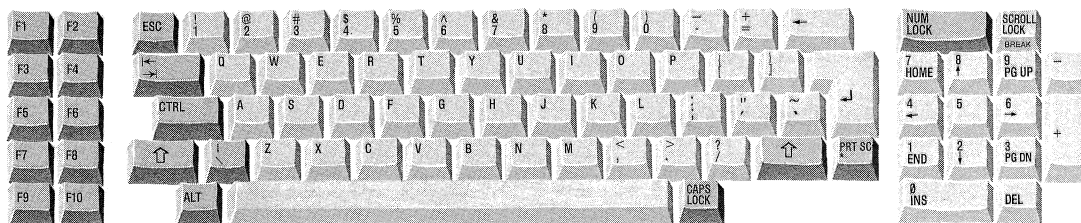





THE MAIN KEYBOARD

Key positions in the main keyboard are similar to a standard typewriter. Unlike a typewriter, the alphanumeric and punctuation keys are typematic, meaning if they are held down, the character is automatically repeated. The main keyboard also contains keys that perform special (control) functions for the TS 1605. Many of the control functions are defined by the operating system or applications program, and therefore may vary with the program being used. Table 4-1 lists the functions of these control keys, starting at the <ESC> key and moving counter-clockwise around the main keyboard.

Figure 4-2
Main Keyboard Area

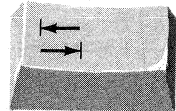

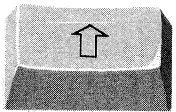
Table 4-1
Main Keyboard Special Keys

Key	Description
	The <ESC> (escape) key is used for special program control functions.
	The <TAB> key moves the cursor to the next program defined tab position.
	The <CTRL> (control) key is used by programs for many special control functions.
	The main keyboard has two <SHIFT> keys. Pressing either of the <SHIFT> keys shifts the alphanumeric and punctuation keys to the upper-case mode. Alphabet characters are displayed as capital letters. All other character keys when pressed with the <SHIFT> key, display the character shown on the upper portion of the key. If the upper-case mode has been set with the <CAPS LOCK> key, the <SHIFT> keys shift the alphabet characters to lower-case.
	The <ALT> (alternate) key is used for special program control functions.
	The <SPACE BAR> is used to add a blank character. The computer treats a blank like an alphanumeric character.

Key Description



The <CAPS LOCK> key locks characters A through Z in the upper-case mode. Pressing <CAPS LOCK> again returns you to the lower-case mode. The caps lock key switches or toggles between lower- and upper-case for the characters A through Z.



Pressing the <SHIFT> key and <PRTSC> (print screen) key simultaneously (<SHIFT>/<PRTSC>) sends a copy of the information displayed on the screen to the printer.

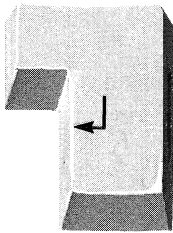

The use of the <ENTER> or <CR> (carriage return) key is defined by the operating system or applications program being used. In TeleDOS, the enter key is used to send a command to the operating system for execution. Refer to the appropriate manual for its specific function.

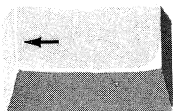

The <BACKSPACE> erases the character to the left of the cursor and moves the cursor one position to the left.

NUMERIC KEYPAD

The TS 1605 has numeric keypad keys that can be operated in two ways: as typical numerical keys for accounting applications, or as cursor movement and editing keys. You can use the <NUM LOCK> key to switch or toggle between the two modes.



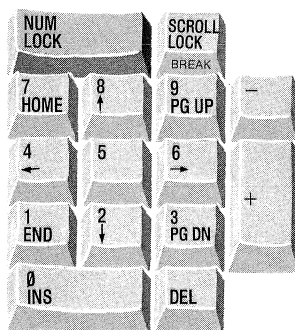
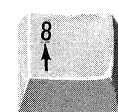

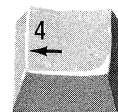
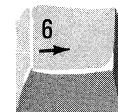

**Figure 4-3
Numeric Keypad**



The functions of the cursor movement and editing keys are defined (determined) by the operating system or applications program being used. Table 4-2 lists the intended use of these keys.

NOTE! TeleDOS does not use the cursor movement or editing key functions of the numeric keypad.

Table 4-2
Numeric Keypad Intended Functions

Key	Description
	The <NUM LOCK> (number lock) key switches or toggles the numeric keypad between the numeric key functions and the cursor movement/editing key functions.
	The <SCROLL LOCK> or <BREAK> key is used for special program control functions.
	The <HOME> key moves the cursor to the upper-left corner of the screen, called the Home position.
	The <CURSOR UP> key moves the cursor to the character position one line above its current position.
	The <PGUP> (page up) key scrolls the screen up one screen display.
	The <CURSOR LEFT> key moves the cursor one character position to the left without deleting any characters.
	The <CURSOR RIGHT> key moves the cursor one character position to the right without deleting any characters.
	The <END> key moves the cursor one character position to the right of the last character on the line the cursor is currently on.

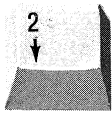
Key**Description**

The <CURSOR DOWN> key moves the cursor to the character position one line below the current cursor position.



The <PGDN> (page down) key scrolls the screen down one screen display.

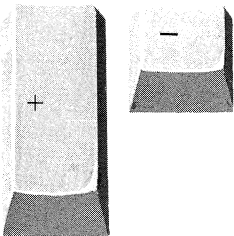

The plus and minus keys have no program-defined functions. When pressed, they enter a plus or minus character on the screen.

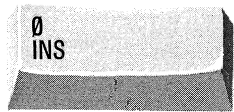

The <INS> (insert) key switches or toggles between the insert and overwrite modes. In the insert mode, a character typed at the keyboard is inserted into the current line at the cursor position and all characters to the right of the cursor are moved one position to the right. In the overwrite mode, a character typed at the keyboard replaces the character at the cursor position.



The (delete) key deletes the character at the current cursor position. All characters to the right of the deleted character are moved one position to the left.

FUNCTION KEYS

The function keys, labeled F1 through F10, are always controlled by the program being used. Many (but not all) applications programs use the function keys to perform special functions to make the program easier to use. To find out the functions assigned to the function keys, refer to the user's manual for that particular program.

Figure 4-4
Function Keys

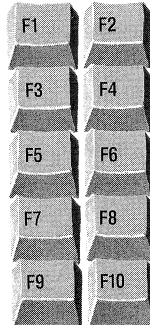

SPECIAL KEY COMBINATIONS

Certain key combinations perform special functions for the TS 1605 regardless of the program being used. Table 4-3 lists the key combinations and their functions.

Table 4-3
Special Key Combinations

Keys	Function	Description
<CTRL>/<ALT>/	Reset	Stops all program activity and the computer loads the operating system from the diskette in drive A.
<CTRL>/<NUM LOCK>	Pause	Stops the scrolling of the screen display so you can read the screen. Press any character key to continue.
<CTRL>/<BREAK>	Break	Interrupts current program activity and returns to the operating system or applications program (the return point is determined by the program or operating system).

5. RUNNING APPLICATIONS PROGRAMS

The TS 1605 is designed to run many different types of applications programs, including those written for the IBM Personal Computer (IBM PC). Applications programs can range from general purpose programs like word processing and financial planning to programs for specific tasks like real estate investment, medical or dental records, or payroll. Programs available include:

- * Word processing
- * Data base management
- * Financial planning and analysis
- * Accounts payable
- * Accounts receivable
- * General accounting
- * Business Graphics
- * Real Estate investment
- * Inventory Control
- * Payroll
- * Record keeping
- * Mailing lists
- * Games
- * Programming languages
 - Macro Assembler
 - BASIC
 - COBOL
 - FORTH
 - FORTAN
 - Pascal

Due to the wide variety of applications programs available, there is no one set of instructions that can be given that will work to start every program. To load and run your applications program, refer to the user's manual that you received with the program.



6. WORKING WITH DISKETTES

Floppy diskettes contain the software or programs that run your computer. Diskettes are used to store operating systems, applications programs, text, and data. Figures 6-1 and 6-2 show the parts of a floppy diskette.

Figure 6-1
Floppy Diskette

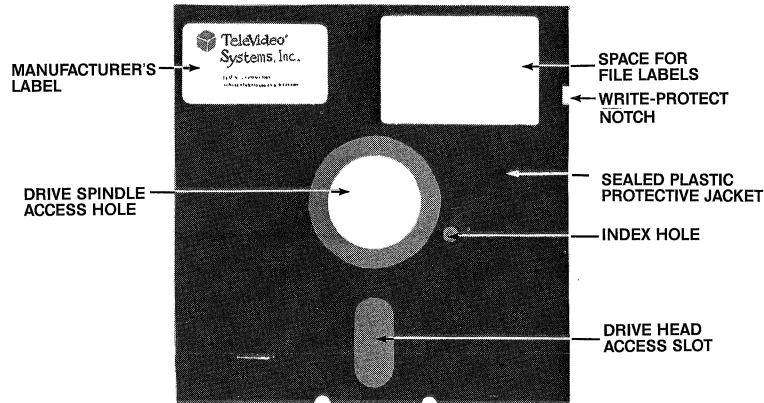
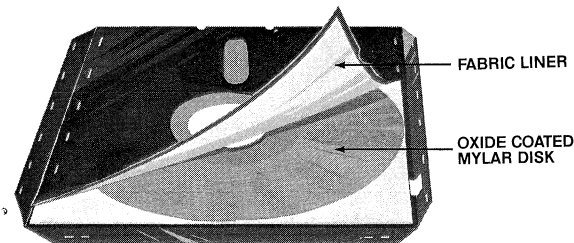

Figure 6-2
Diskette Inside Permanent Plastic Enclosure



When you put a diskette into the disk drive and close the drive, the disk drive spins the diskette inside its cover. There is a drive recording head on each side of the diskette that is lowered onto the magnetic diskette surface whenever the drive is closed. The disk drive head moves back and forth along the diskette access slot as it reads from or writes to the diskette.

HANDLING AND STORING DISKETTES

Diskettes can provide reliable service if you follow these simple rules:

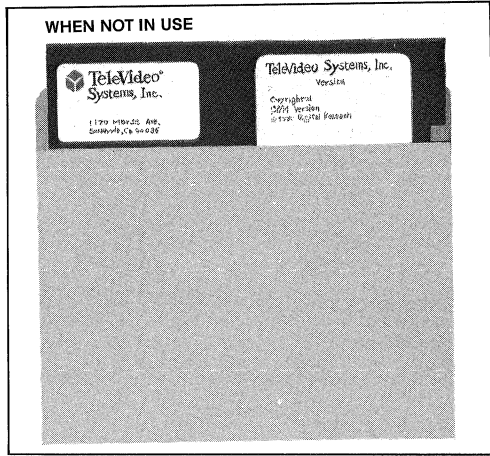

Return diskettes to their paper dust jacket when not in use. Store diskettes in an upright position in a dust-free storage container.



Do not touch the exposed recording surface of the diskette. Small scratches, dust, food, or tobacco particles may make information on your diskette unusable.

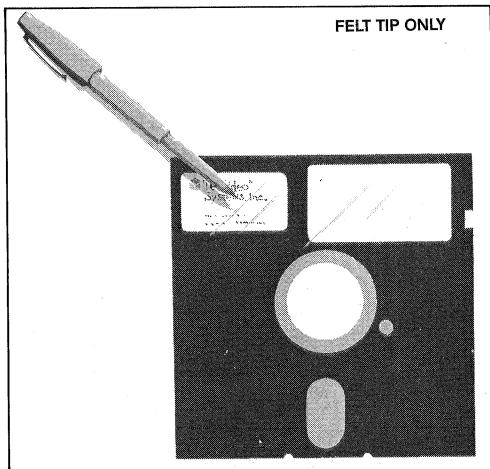

Use a felt-tip pen and press lightly. Never write on the diskette label with a pencil or ballpoint pen. Whenever possible, write information on the label before placing the label on the diskette.

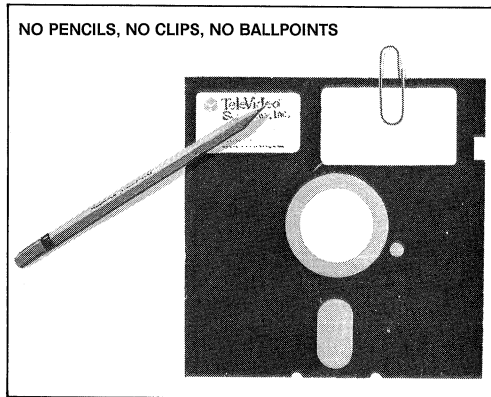

Never attach anything to the diskette or its dust jacket with paperclips or staples.

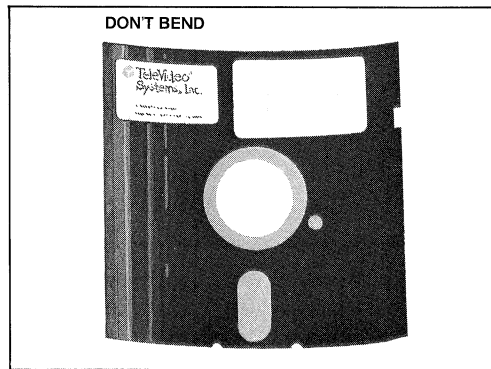

Never bend or fold diskettes.

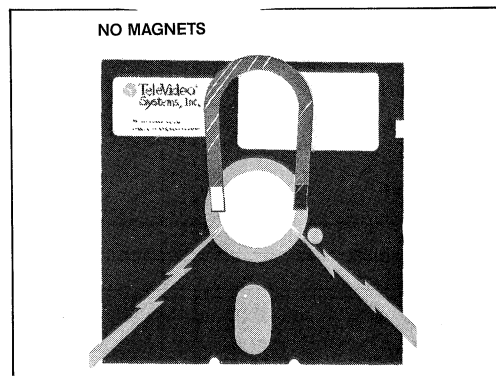

Keep diskettes away from sources of magnetic fields such as telephones, magnetic paper clip holders, typewriters, or electronic calculators.

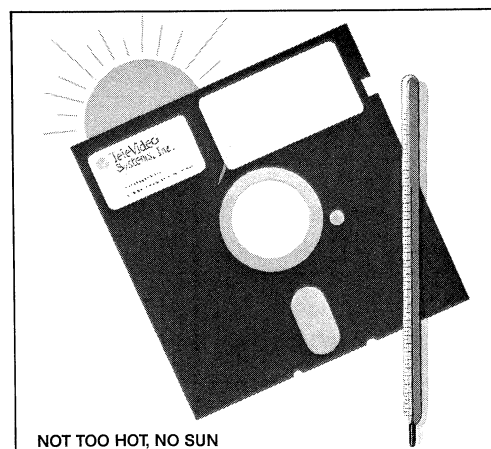

Store diskettes in a cool place, away from direct sunlight or sources of heat.

FORMATTING DISKETTES

Since each computer system has its own format requirements, blank diskettes are not formatted by diskette manufacturers. Before a new diskette is used, it must be formatted for the TS 1605.

The format process prepares a diskette to receive information. It checks the diskette for bad spots and builds a directory to hold information about the files that will eventually be stored on the diskette.

NOTE! The format process will erase any data currently on a diskette.

To format a diskette for the TS 1605, you can use the FORMAT utility program command described in Chapter 2 of the TeleDOS operating system User's Manual.

BACKING UP DISKETTES

When diskettes work perfectly and you don't accidentally erase or change data, it is perhaps difficult to understand why back-up diskettes are so necessary. However, accidents do happen and diskettes eventually wear out. To protect your investment of time and effort, learn to make a backup copy of each diskette on a regular basis. You can use the DISKCOPY utility program command described in Chapter 2 of the TeleDOS operating system User's Manual to copy diskettes.

COPYING MASTER DISKETTES

When you purchase software, you receive it on a **master diskette**. The diskette that your operating system came on is a master diskette. It is important to copy master diskettes before starting to use them. Always use the copies for normal use and keep the original master diskettes as a backup in case a working copy is damaged or wears out.

To copy master diskettes, you can use the DISKCOPY utility program command described in Chapter 2 of the TeleDOS operating system User's Manual.

WRITE-PROTECTING DISKETTES

When information from one diskette is copied onto another diskette, it superimposes the new data on the information originally there. If the information on a diskette, such as your system diskette, is particularly important, you may want to protect it from being copied over by **write-protecting** the diskette.

To write-protect a diskette, place one of the self-adhesive tabs that are supplied by manufacturers with each box of blank diskettes over the write-protect notch (see Figure 6-1). With the tab in place, the drive is not allowed to write information on the diskette. When you want to remove the protection, remove the tab from the diskette.

Of all the habits which you can develop as a computer user, probably the careful handling of diskettes and the faithful backing up of data are the most desirable.

C

C

C

7. CONNECTING PERIPHERALS

The TS 1605 comes equipped with built-in connectors for attaching a printer and modem. This chapter provides instructions for connecting a printer or modem to these connectors.

ATTACHING CABLES

Cables are needed to connect peripherals to your computer. The types of cables needed are determined by the requirements of the peripheral devices. Your computer store representative can supply the appropriate cables for attaching peripheral devices.

Cable connectors have D-shaped end connectors (see Figure 7-1). These fit onto the D-shaped pin connectors on the rear panel of your computer. To install a cable, fit the pin connector onto the rear-panel connector, then gently but firmly push the cable connector on.

Figure 7-1
D-Shaped Cable Connector

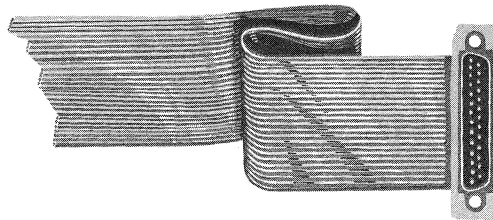

Some connectors come supplied with mounting screws in the flange on the sides of the D-connector housing. These screws line up with the threaded holes in the rear panel connectors. The screws need only be finger tightened. This prevents a cable from being accidentally pulled from the computer.

Leave some slack as you connect the cables. If you are using a round cable, coil it loosely and secure it with a rubberband. If you are using a flat, ribbon cable, fold it accordion-style as shown in Figure 7-2. Coiling ribbon cable can adversely affect system performance.

Figure 7-2
Correctly-Folded Excess Ribbon Cable

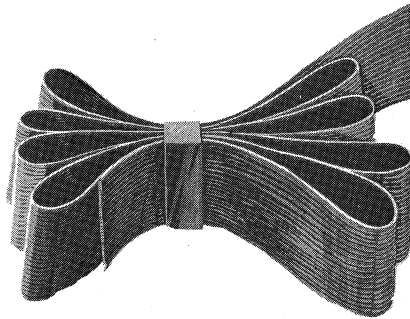

PARALLEL PRINTERS

The connector on the back of the TS 1605, labeled **PARALLEL PRINTER**, is designed to connect to a Centronics-type parallel printer. The **PARALLEL PRINTER** connector uses a 25-pin D-shell connector instead of the standard 36-pin parallel printer cable connector (see Appendix E for connector pin assignments); therefore, a special printer cable is needed. Your computer store representative can supply you with the correct cable for connecting your printer to the TS 1605.

When you get the proper printer cable, you can connect the printer by attaching the 25-pin connector end of the cable to the **PARALLEL PRINTER** connector and the other end to the connector on the printer.

For information on operating your printer, refer to the user's manual that was supplied with your printer.

MODEMS

The connector on the back of the TS 1605, labeled **RS-232C**, is designed to connect to a modem. The **RS-232C** connector uses a standard 25-pin D-shell connector (see Appendix E for connector pin assignments). To connect a modem, attach one end of an **RS-232C** cable to the connector labeled **RS-232C** and the other end to the modem's **RS-232C** connector.

To operate the modem, refer to the manuals supplied with the modem and communications software package you are using.

8. INSTALLING OPTION BOARDS

Option boards can be installed into the TS 1605 to add features or enhancements to your computer. Examples are memory boards to expand memory beyond 256K, a 1605N card for connecting the TS 1605 into one of TeleVideo's network systems, or the board for the optional expansion unit, giving you four additional expansion slots.

This chapter explains how to install an option board into the case of the TS 1605. Option boards are installed piggy-back fashion on the main system board and require major disassembly of the TS 1605 case. **IT IS RECOMMENDED THAT OPTION BOARDS BE INSTALLED BY A QUALIFIED TECHNICIAN.**

The following is a step-by-step procedure for installing an option board. A Phillips screw driver is required for the installation.

1. Turn off the power and unplug the power cord from the power source (wall outlet).
2. Place the TS 1605 system on a workbench or table with at least a 3 x 3 foot work area. Position the TS 1605 with the floppy drive end of the case facing you (the right side).
3. Remove the three Phillips head screws and flat washers located along the lower edge of the case (see Figure 1).

Figure 8-1
Location of Case Screws

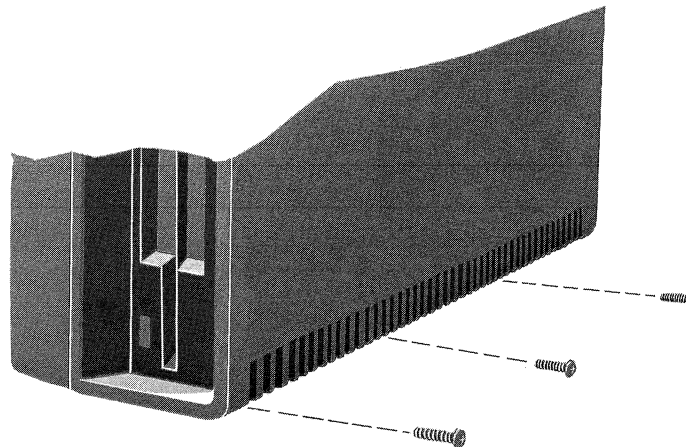

4. Open the case by pulling out and up from the bottom as if it were hinged at the top (see Figure 8-2). There are tabs on the top of the side case that fit into slots in the main system case. Once the side case is approximately 30 degrees to the main system case, the side case can be removed from the main system case. Carefully set the side case down flat.

Figure 8-2
Removing the Side Case

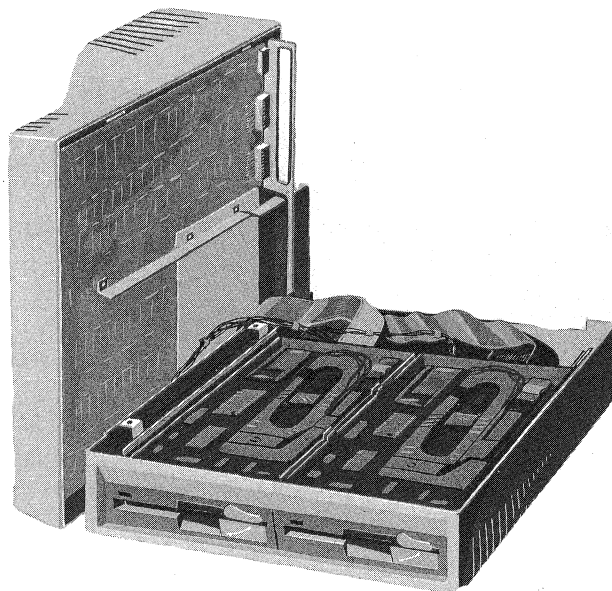
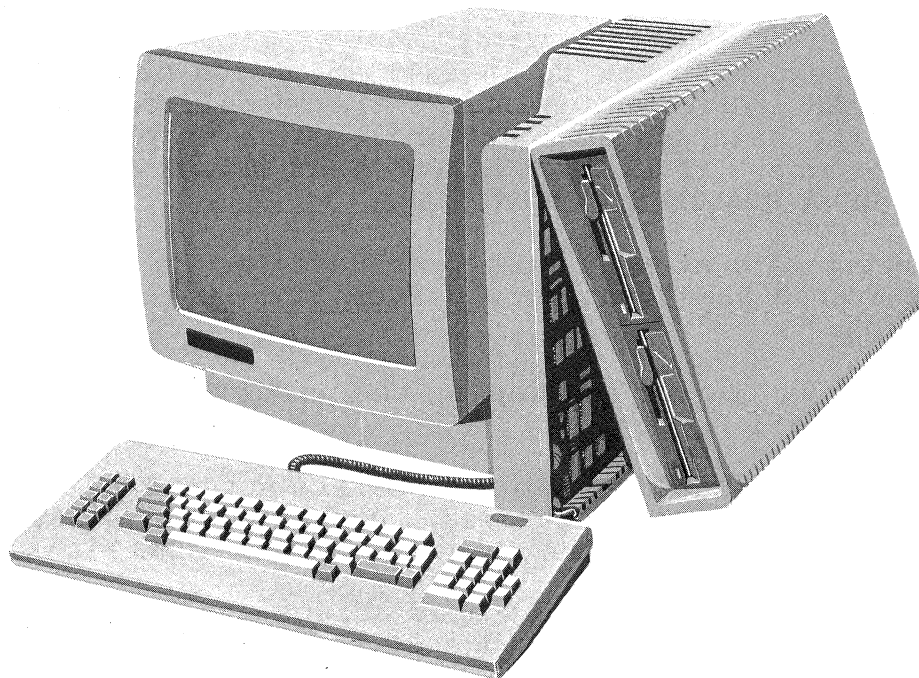

5. Disconnect the disk drive power cable connectors from the disk drives (see Figure 8-3).

Figure 8-3
Disconnecting the Disk Drive Cables

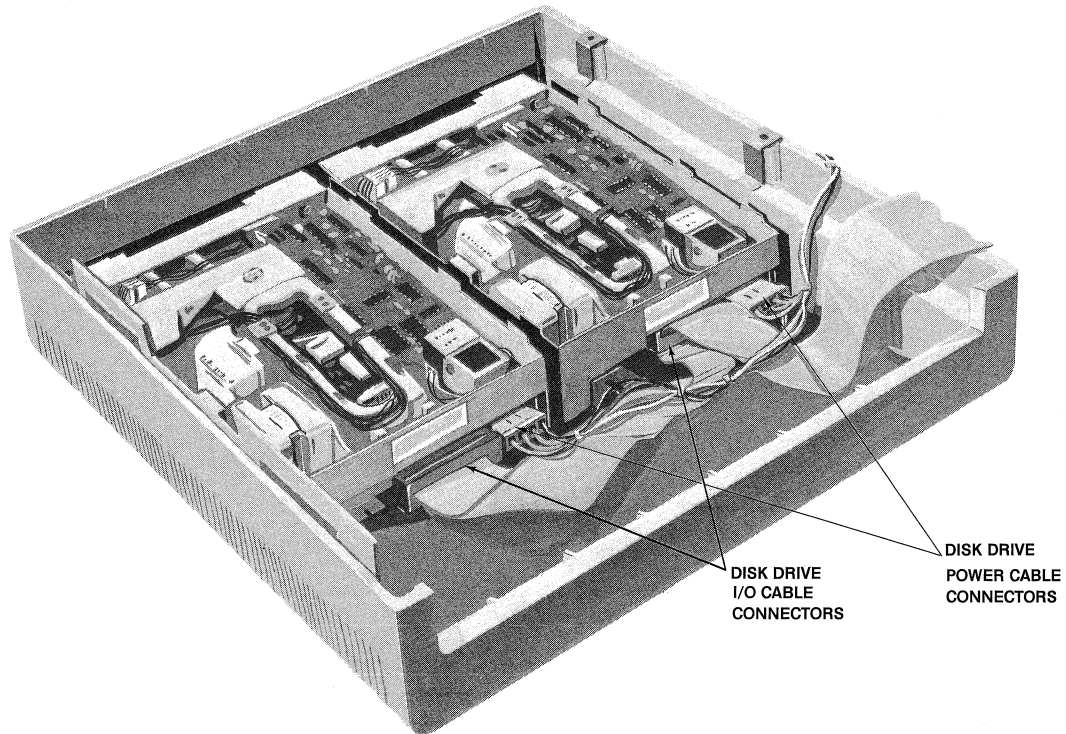

6. Disconnect the disk drive interface ribbon cable by removing the cable connectors from the disk drives (see Figure 8-3).
7. Disconnect the black ground wires between the main unit and the disk drives by removing the screws attaching them to the metal housing in the side case.
8. The side case containing the disk drives can now be moved aside to allow easier access to the system board. Cover the side case to prevent foreign material from entering the disk drives.
9. If the option board has a rear panel connector, the cover in the rear panel shroud has to be removed. To remove the cover, squeeze together the three sets of hook-like clips and push the cover out the back of the shroud.

Figure 8-4
Rear Shroud Connector Cover

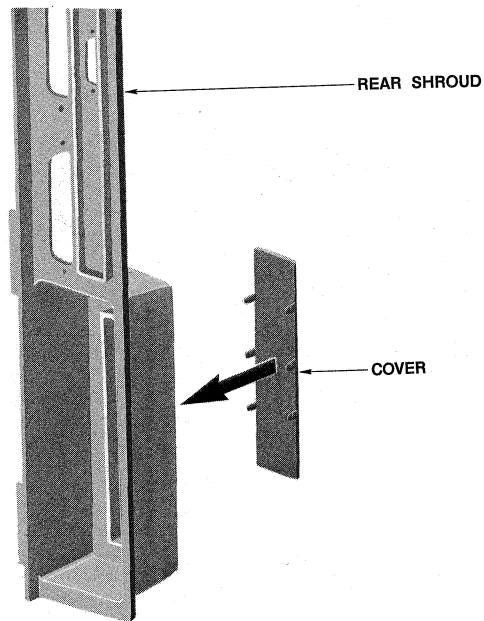

10. Remove the three Phillips head screws attaching the top option board bracket to the standoffs on the system board. Remove the bracket from the system board.

Figure 8-5
System Board

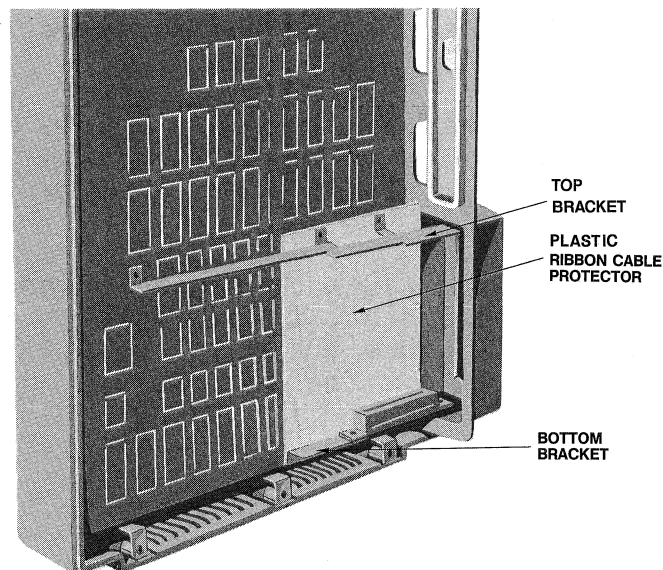

11. Loosen the option board attaching screw on the top bracket. Attach the bracket to the option board by sliding the body of the attaching screw into the slot on the option board retaining bracket and fitting the plastic guide over the top edge of the option board (see Figure 8-6).

Figure 8-6
Attaching the Top Bracket to the Option Board

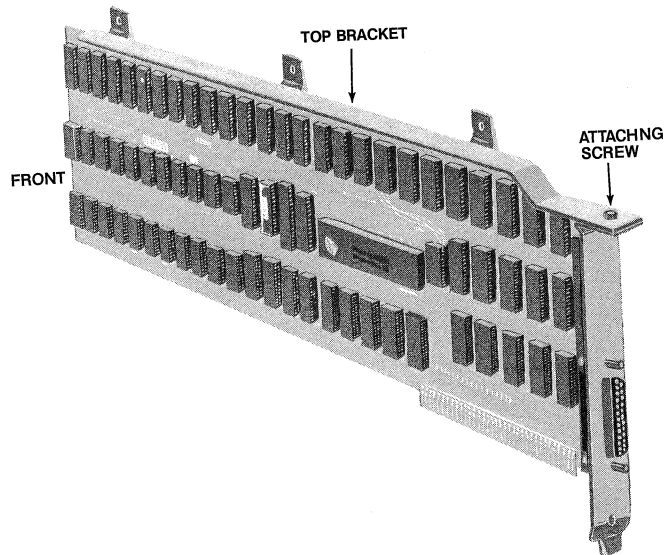

12. Remove the two Phillips head screws attaching the lower option board bracket from the standoffs on the system board. You do not need to disconnect the ribbon cable for the edge connector socket.
13. Install the option board edge connector into the edge connector socket on the lower bracket (see Figure 8-7).
14. Move the option board into position (with the two brackets attached - see Figure 8-8). Install the three screws attaching the top bracket to the standoffs on the system board. Make sure the middle and right mounting screws go through the top two holes in the thin plastic ribbon cable protector, and the protector is in place between the standoffs and the bracket.

Figure 8-7
Attaching the Edge Connector Bracket

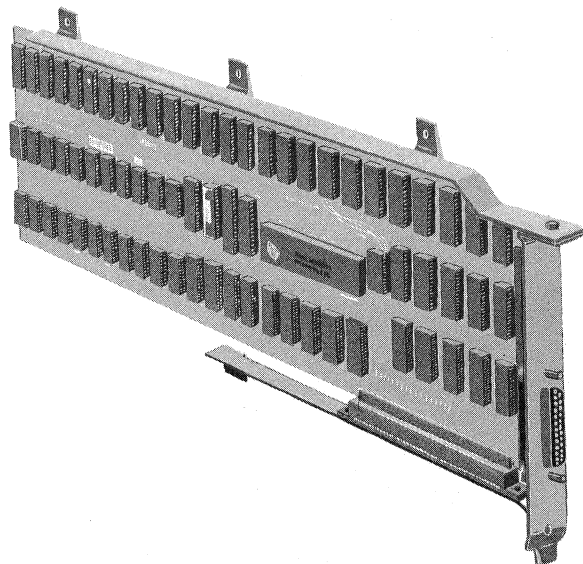
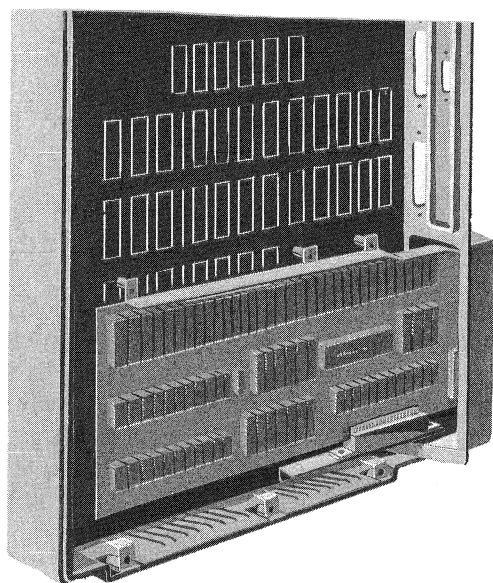

Figure 8-8
Positioning the Option Board



15. Install the two screws attaching the lower bracket to the standoffs on the system board. The mounting screws will also go through the lower mounting holes of the thin plastic ribbon cable protector.
16. Move the side case with the disk drives into position in front of the main system.
17. Connect the disk drive interface ribbon cable to the connectors on the disk drives (see Figure 8-3).
18. Connect the power supply cable connectors to the disk drives (see Figure 8-3).
19. Connect the black ground wires to the metal housing in the side case.
20. Lift the side case into position, inserting the tabs on the top of the side case into the slots in the top of the main case. Pivot the case down into position.
21. Replace the three case screws and washers.



9. CARING FOR THE TS 1605

To keep your TS 1605 in the best condition, keep it clean and inspect it periodically.

CARE

1. When not in use, place a dust cover over the computer to prevent dust from entering the computer through the cooling vents.
2. Periodically vacuum the keyboard with a soft brush attachment (or use a small soft brush).
3. Clean the housing with a soft, lint-free cloth.

INSPECTION

Check the cabinet and keyboard for damage or excessive wear periodically.

1. Inspect the cabinet for cracks or breaks.
2. Check each keyboard key for free movement.
3. Inspect the cables and pin connectors twice a year for damage. Inspect the cable connectors for kinks or other signs of excessive stress (such as stretching).

Refer any damage to a qualified service technician at your computer store.

SERVICE

If you need to call your computer store for service, you will be asked for the serial number of your computer. The serial number is located on a label on the back of the computer. For future reference, write the serial number, the date you took delivery, and the name and phone number of your computer store and service center in the space provided on the inside of the rear cover of this manual.

Service During Warranty

Your computer is under warranty as described in the front of the manual. If you need service on your TS 1605 while it is under TeleVideo's limited warranty, call your computer store representative for information.

On-Site Service After Warranty

You can obtain on-site service after warranty from authorized third-party service centers.

SHIPPING THE TS 1605

Should you need to ship the TS 1605, follow these steps:

1. Open the drive latches. If you kept the cardboard inserts that were in the drives when the TS 1605 was shipped, reinsert them now. If you did not keep the inserts, you can place a blank diskette in each drive. Turn the drive latches to the horizontal position to close the drives.
2. Pack the unit in the original TeleVideo shipping container or use other suitable materials.

10. MAINTENANCE

This chapter provides you with some procedures to try if your computer is not working properly, along with instructions on how to change the fuse.

TROUBLESHOOTING

The information provided in Table 10-1 may enable you to resolve operating problems without placing a service call. If your computer does not work properly after you have followed the suggestions given here, call your computer store or service center.

Table 10-1
Troubleshooting Procedures

Problem	Action
THE COMPUTER IS NOT OPERATIONAL AFTER THE POWER SWITCH IS TURNED ON.	<p>Unplug the power cord and plug it in again.</p> <p>Test for power by plugging something else in the same electrical outlet.</p> <p>Check the line fuse (as described in the section Changing the Fuse in this chapter) and replace it if necessary. If the fuse blows again, call your computer store.</p>
DATE PROMPT DOES NOT APPEAR AFTER TeleDOS HAS BEEN LOADED	<p>Remove the system diskette and reinsert it. Hold the diskette with the label facing left and the write-protect notch down. Turn the drive latch to the horizontal position and reset the system by pressing the <CTRL>/<ALT>/ simultaneously.</p> <p>Try using the master system diskette. If that works, make a new working copy.</p>

Problem**Action**

SCREEN DISPLAYS SYSTEM PROMPT BUT DOES NOT RESPOND TO OPERATOR COMMAND.

Check to see that the appropriate diskette is in the active drive.

Be sure the latch on the active drive is in the horizontal position.

Make sure the keyboard is properly connected.

TS 1605 APPEARS TO BE RUNNING BUT CURSOR DOES NOT APPEAR.

Adjust display contrast settings on the rear panel.

TS 1605 LOCKED UP (DOES NOT RESPOND TO KEYBOARD).

Make sure the keyboard is properly connected.

Reset the TS 1605 by pressing <CTRL>/<ALT>/.

THE SCREEN IS DEAD.

Turn the computer off and check the fuse.

PRINTER DOES NOT PRINT WHAT IS TYPED.

Reconnect printer cable, being sure it is completely on the pin connector.

Check printer cable configuration.

Check for printer fault (out of paper or ribbon).

THE MODEM DOES NOT RESPOND OR TRANSMIT TO A REMOTE PROCESSOR.

Unplug the modem and plug it in again. Turn its power on and off, and reconnect the modem cable to the RS-232C port.

Make sure the modem and computer are operating at the same baud rate.

CHANGING THE FUSE

The computer has one exterior fuse that is accessible from the rear panel.

To check or change the exterior fuse, turn the power off, unplug the cord from the the power outlet, and unscrew the fuse holder (see Figure 10-1). The fuse is a small glass cylinder. If the thin wire inside the fuse is still intact, the fuse should be functional (see Figure 10-2). If the thin wire is broken and/or if the glass is blackened, the fuse has blown and must be replaced (see Figure 10-3).

STOP! Do not replace a blown fuse until you know what caused the fuse to blow. The problem could be with the system or with the power outlet.

Figure 10-1
Exterior Fuse Location

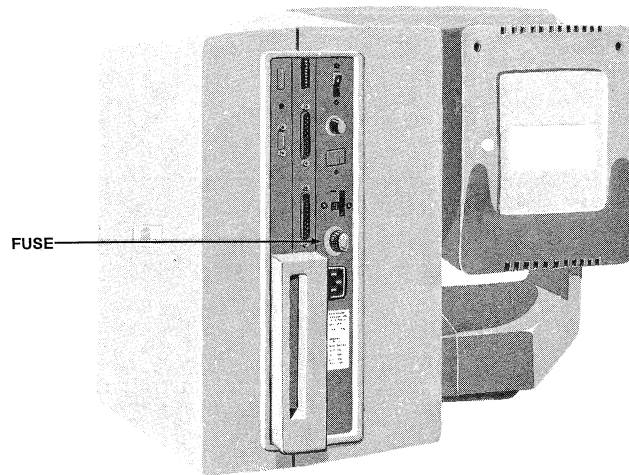

Figure 10-2
Good Fuse



Figure 10-3
Blown Fuse



To replace the fuse, slip the old fuse from the fuse holder and insert a new fuse. See Appendix D for information about fuse ratings. You can purchase new fuses from your computer store. If the newly-replaced fuse blows out immediately, do not replace it with another fuse. Call your computer store.



TS 1605 User's Manual

APPENDICES

- A. Specifications
- B. Suggested References
- C. Buying Additional Diskettes
- D. Changing the Voltage Switch to 230 Volts
- E. Connector Pin Assignments
- F. Rear Panel Switch Settings
- G. Optional Color Monitor Connectors
- H. Tips for Using Option Boards with Asynchronous Communications



APPENDIX A SPECIFICATIONS**MICROPROCESSOR/MEMORY**

CPU	Intel 8088 16-bit microprocessor (processor speed 5 MegaHertz)
MEMORY	128 Kbytes dynamic RAM (expandable to 256K)
	16 Kbytes RAM video graphics display memory
	8 Kbytes EPROM with bootstrap loader, and hardware diagnostics routines

DISKETTE DRIVE

TYPE	Slim-line 5 1/4-inch floppy disk drives
DISKETTES	48 TPI double-sided, double-density 5 1/4-inch floppy diskettes
	Soft sectored, 512 bytes/sector, 9 sectors/track, 40 tracks/side, 2 sides/diskette
STORAGE CAPACITY	500 Kbytes per drive unformatted 368.6 Kbytes per drive formatted 737.2 Kbytes total (formatted)
TRANSFER RATE	250 Kbits/second
ACCESS TIME	84 milliseconds average 120 milliseconds maximum
INPUT/OUTPUT	
SERIAL I/O	RS-232C asynchronous serial port; configured as DTE Fifteen baud rates (50, 75, 110, 134.5, 150, 300, 600, 1200, 1800, 2000, 2400, 3600, 4800, 7200, 9600)
PARALLEL I/O	Parallel (Centronics-type) printer port (DB-25S connector)

POWER REQUIREMENTS**EXTERNAL**

U.S. 115 VAC (+/- 10%) 50/60 Hertz
INTERNATIONAL 115/230 VAC (+/- 10%) 50/60 Hertz

POWER CONSUMPTION 1.30 amp maximum at 115 VAC
0.65 amp maximum at 230 VAC

POWER CORD NEMA standard 5-15R, 3-prong receptacle
(US only)

ENCLOSURE

DIMENSIONS Height: 14.5 inches (36.8 cm)
Width: 18.5 inches (47.0 cm)
Depth: 14.5 inches (36.8 cm)
Weight: 52.0 pounds (23.6 kg)

COMPOSITION Injection-molded plastic

ENVIRONMENT

OPERATING (WITH DISKETTE) 50 to 85 degrees Fahrenheit
10 to 30 degrees Celsius
Maximum humidity 95 percent relative,
noncondensing
Maximum altitude 10,000 ft. above sea level

NONOPERATING (SHIPPING) 32 to 120 degrees Fahrenheit
0 to 50 degrees Celsius

CRT SPECIFICATIONS

MONITOR SIZE 14-inch (measured diagonally)
P31 green phosphor

VIDEO DISPLAY 25 lines
80 characters per line
2000 characters per screen
Video attributes:
Double intensity
Blinking fields
Reverse video

CHARACTER FONT 7 x 7 character font with one descender
8 x 9 dot matrix

DISPLAYED CHARACTER SET	256 character codes 96 standard ASCII characters 48 foreign language support characters 48 block graphic support characters 16 Greek characters 15 scientific characters 15 special game support characters
REPEAT	20 cps auto-repeat
EDITING FEATURES	Typeover Clear screen to space or null Character insert and character delete Absolute cursor addressing Erase to end of line or field Line edit
CURSOR CONTROLS	Left, right, up, and down arrows, home, tab, back tab, back space, end of line, enter

APPENDIX B SUGGESTED REFERENCES

The following books are useful references for using TS 1605 hardware and the TeleDOS operating system.

1. Peter Norton, MS-DOS and PC-DOS: User's Guide, R. J. Brady Company, A Prentice-Hall Company, Bowie, Maryland 20715

An introduction to the MicroSoft Disk Operating System that gives the beginner a complete explanation of DOS fundamentals including IBM's PC-DOS (which is similar to TeleDOS). This book contains many examples and explanations.

2. Morse, Stephen, The 8086/8088 Primer, 2nd ed., Hayden Book Company, Inc., Rochelle Park, N.J.

An introduction to the architecture, system design, and programming of the 8086 and 8088 microprocessors.

3. Rector, Russell and Alexy, George, The 8086 Book (includes the 8088), Osborne/McGraw-Hill, 630 Bancroft Way, Dept. UB, Berkeley, CA 94710

This book is for those people with a working knowledge of general microprocessor concepts. The 8086 Book focuses on three topics: general programming concepts and practices, the 8086 microprocessor with its assembly language, and logic design using the 8086 microprocessor.

4. TS 1605 Technical Reference, TeleVideo Systems, Inc.

This manual provides a description of the TS 1605 hardware and provides programming information for the system level programmer.

APPENDIX C BUYING ADDITIONAL DISKETTES**SOURCES**

Any TeleVideo Systems dealer or distributor

Retail Computer Center

SPECIFICATIONS

Any new diskettes should meet these specifications to ensure data integrity:

Type	Floppy minidiskettes
Size	5.25-inch
Technology	Double sided, double density
Format	Soft sectored
	Guaranteed for 48 tpi drives
	40 tracks per side

RECOMMENDED BRAND

Brand	Part No.	Manufacturer
Dysan Diskettes 104/2D	805008-02	Dysan Corporation Santa Clara, CA

QUALITY

You should purchase the best quality diskettes available to ensure data integrity.

LIFE EXPECTANCY

Depending on the care and amount of use given your diskettes, they may last from six months to two years. Many users automatically phase out diskettes periodically. Factors such as number of disk accesses, quality of diskette, environment, and care can significantly affect their life expectancy.

One of the first signs of diskette wear will be incorrect data. The care with which you handle and store diskettes is probably the most important single factor in life expectancy of diskettes.

APPENDIX D CHANGING THE VOLTAGE SWITCH TO 230 VOLTS

The TS 1605 is set at TeleVideo for use with the 115 volt power standard. To use the TS 1605 on the 230 volt international power standard, you must change the line fuse and change the setting of the power switch on the back of the TS 1605. This appendix explains how to change the fuse and voltage switch.

Be sure that the power is off and the power cord is disconnected from the power outlet before making the following changes.

Inserting the Fuse for 230 Volts

The system is shipped with the fuse installed to correspond to 115 volts. A .75A slow blow fuse is needed for operation on the 230 volt International power standard.

**Table D-1
Fuse Table**

Amperes	Maximum Fuse Voltage	Power Standards
1.5 Slow blow	250V	115V U.S.
0.75 Slow blow	250V	230V International

Unscrew the fuse holder from the back panel of the unit and remove the 1.5A fuse. Place one end of the .75A fuse into the holder and insert the fuse into the unit. Press gently while screwing the holder back into place. See Figure D-1.

**Figure D-1
Fuse**

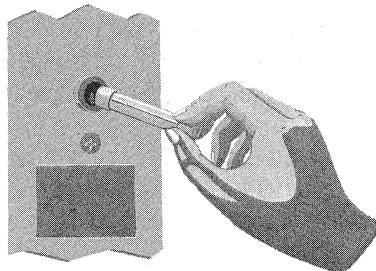

Changing the Voltage Switch to 230 Volts

To change the voltage configuration to 230 volts, you need to switch the voltage switch on the back panel of the Computer.

The voltage switch is locked into place by a bar that is removable. To remove the bar and switch from 115V to 230V, follow these directions.

1. Using a Phillips screwdriver, remove the screw from the bottom of the bar that spans the 230V side of the switch. See Figure D-2.

Figure D-2
Voltage Switch

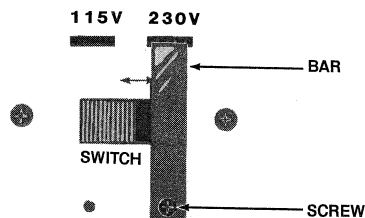

2. Carefully remove the bar.
3. Firmly push the switch to the 230V position (to the right).
4. Fit the top horizontal section of the bar carefully into the slot above the 115V position. Match the screw hole of the bar with that under the 115V position.
5. Insert and tighten screw.

STOP! Contact your computer store if you are not sure that your power requirements match that of the unit. **Trying to operate the unit with the wrong power configuration can seriously damage the system.**

APPENDIX E CONNECTOR PIN ASSIGNMENTS

The following tables list the pin connector assignments for the parallel printer port and the RS-232C serial port.

Table E-1
Parallel Printer Port
 (25-Pin D-Shell Connector)

Pin	I/O	Function	Pin	I/O	Function
1	O	- Strobe	10	I	- Acknowledge
2	O	Data 0	11	I	Busy
3	O	Data 1	12	I	Paper out
4	O	Data 2	13	I	Select
5	O	Data 3	14	O	- Auto feed
6	O	Data 4	15	I	- Error
7	O	Data 5	16	O	- Initialize printer
8	O	Data 6	17	O	- Select input
9	O	Data 7	18-25		Signal ground

Table E-2
RS-232C Serial Port
 (25-Pin D-Shell Connector)

Pin	I/O	Function
1		Signal ground
2	O	Transmitted data
3	I	Received data
4	O	Request to send
5	I	Clear to send
6	I	Data set ready
7		Signal ground
8	I	Carrier detect
9	O	+ Transmit current loop return
11	O	- Transmit current loop data
18	I	+ Receive current loop data
20	O	Data terminal ready
22	I	Ring indicator
25	I	- Receive current loop return

APPENDIX F REAR PANEL SWITCH SETTINGS

Table F-1 shows the possible section settings for switch SW on the rear panel of the computer.

**Table F-1
Rear Panel Switch Settings**

Section	Position	Function	
1	OFF	Normal operation	
	ON	Test option	
2	OFF	With 8087 co-processor installed	
	ON	Without 8087 co-processor	
3 & 4	3	4	
	OFF	ON	128 Kbytes of RAM on system board
	ON	OFF	192 Kbytes of RAM on system board
	OFF	OFF	256 Kbytes of RAM on system board
5 & 6	5	6	
	OFF	ON	Color/graphics in 40 x 25 mode
	ON	OFF	Color/graphics in 80 x 25 mode
7 & 8	7	8	
	ON	ON	1 floppy disk drive in system
	OFF	ON	2 floppy disk drives in system
9 & 10			Not used

ON - in the closed position (to the right)

OFF - in the open position (to the left)

To change a setting on the switch, use a ball-point pen and gently push the switch lever to the desired position. Always give the lever a second push to make certain that it is seated properly in the position you have chosen.

STOP! DO NOT USE A PENCIL! Pencil lead is an electrical conductor, and any small grains of lead falling into the switch sections may cause a malfunction.

APPENDIX G COLOR MONITOR CONNECTORS

Your TS 1605 comes standard with connectors for color monitors. These connectors allow you to connect a color monitor and operate both the standard display and the color display at the same time. The connectors are labeled **COMP** and **RGB** for a composite and RGB (Red/Green/Blue) color monitor respectively.

To use a color monitor, connect it to the proper TS 1605 back panel connector with an appropriate cable (the type of cable you need depends on your color monitor, composite or RGB, and the cable connector on your monitor). Plug the color monitor into a power outlet and turn its power switch to the ON position. Now start your TS 1605 as you normally would. The screen display on your TS 1605 is duplicated on the screen of the color monitor.

Color Monitor Connectors

The COMP connector is a standard RCA-type phono jack with signal and ground lines as shown in Table G-1.

**Table G-1
Composite Color Monitor Connector**

Pin	I/O	Function
1	0	Peak-to-peak amplitude
2		Chassis ground

The RGB connector is a 9-pin D-shell connector with pin assignments as shown in Table G-2.

**Table G-2
RGB Color Monitor Connector**

Pin	I/O	Function
1		Ground
2		Ground
3	0	Red
4	0	Green
5	0	Blue
6	0	Intensity
7	0	Reserved
8	0	Horizontal drive
9	0	Vertical drive

**APPENDIX H TIPS FOR USING OPTION BOARDS WITH
ASYNCHRONOUS COMMUNICATIONS**

Your TS 1605 comes equipped with an RS-232C port (connector) for asynchronous communications. This port is internally addressed as the COM1 port. If you add an option board that uses asynchronous communications (such as a modem board, or a memory board with a serial port), this board is considered a second asynchronous communications port and must be configured as COM2. The documentation supplied with your option board should explain how to configure the board, or serial port on the board, as COM2 (or disable the extra serial port if it will not be used).

Serial output through the RS-232C connector on the back panel of the TS 1605 will not occur properly if another asynchronous port exists in the system configured as COM1.

INDEX

Additional manuals, 1.3
ALT (Alternate) key, Table 4-1
Applications programs, 5.1
Attributes, video, A.2

BACKSPACE key, Table 4-1
Brackets, option board, 8.4-8.7, Figures 8-5, 8-6, 8-7
BREAK
 function, 4.6
 key, Table 4-2

Cables
 attaching, 7.1
 connector, 7.1
 correctly folded, 7.1, Figure 7-2
CAPS LOCK key, Table 4-1
Care, 9.1
Carriage return <CR> key, Table 1-1, Table 4-1
Cleaning, 9.1
Color monitors, G.1
Composite color connector, G.1
Connecting
 cables, 7.1
 color monitors, G.1
 keyboard, 2.2, Figure 2-2
 modems, 7.2
 peripherals, Chapter 7
 printers, 7.2
Connectors
 cable, 7.1
 composite color, Table G-1
 pin assignments, E.1
 RGB color, Table G-2
Contrast
 adjusting, 3.2
 knob, Figure 3-2
Control
 functions, 4.1
 key, (CTRL), Table 4-1
Conventions, notation, 1.3, Table 1-1
Cord, power, 2.4
<CR> carriage return, Table 1-1, Table 4-1
CRT specifications, A.2
CTRL (Control) key, Table 4-1

- Cursor
 - controls, A.3
 - down key, Table 4-2
 - left key, Table 4-2
 - right key, Table 4-2
 - up key, Table 4-2
- DEL (Delete) key, Table 4-2
- Dimensions, A.2
- DIP switch, F.1
- Disk drives, specifications, A.1
- Diskettes
 - backing up, 6.4
 - buying, C.1
 - care, summary of, 6.2-6.3
 - copying, 6.4
 - copying master, 6.4
 - description, 6.1, Figures 6-1, 6-2
 - formatting, 6.4
 - handling, 6.2-6.3
 - inserting, 3.3, Figure 3-3
 - master, 6.4
 - recommended, C.1
 - specifications, C.1
 - storing, 6.2-6.3
 - write-protecting, 6.4
- END key, Table 4-2
- Enclosure, A.2
- ENTER key, Table 4-1
- Environment, 2.1, A.2
- ESC (Escape) key, Table 4-1
- F1 through F10, 4.5, Figure 4-4
- Format, user's manual, 1.2
- Formatting diskettes, 6.4
- Function keys, 4.5, Figure 4-4
- Fuse
 - changing, 10.1-10.2
 - inserting for 230V, D.1
 - location, D.1
 - rating, Table D-1
- HOME key, Table 4-2
- Input/Output, A.1
- INS (insert) key, Table 4-2
- Inserting floppy diskette, 3.3, Figure 3-3
- Installation
 - general, Chapter 2
 - option boards, Chapter 8
- Interference, magnetic, 2.2

Key combinations, special, 4.6, Table 4-3

Keyboard

connection, 2.2, Figure 2-2

description, Chapter 4, Figure 4-1

function keys, 4.5, Figure 4-4

main, 4.1-4.2, Figure 4-2, Table 4-1

numeric keypad, 4.3-4.5, Figure 4-3, Table 4-2

Location, selecting correct, 2.1

Magnetic interference, 2.2

Maintenance, Chapter 10

Manual, format, 1.3

Manuals, additional, 1.3

Master diskette, 6.4

Memory, additional, A.1

Modem, connecting, 7.2

Notation conventions, 1.3, Table 1-1

Notes, 1.2

Numeric Keypad, 4.3-4.5, Figure 4-3, Table 4-2

NUM LOCK key, 4.3, Table 4-2

ON/OFF switch, 2.3, Figure 2-4, 3.1, Figure 3-1

Operation, Chapter 3

Operating system, 3.3

Option boards

brackets, 8.4-8.7

description, 8.1

installation, Chapter 8

Page down (PgDn) key, Table 4-2

Page up (PgUp) key, Table 4-2

Pause function, 4.6

Peripherals, 2.5, Chapter 7

Pin connector assignments, E.1

PGDN (Page down) key, Table 4-2

PGUP (Page up) key, Table 4-2

Positioning knob, screen, 2.5, Figure 2-6

Power

cord connection, 2.4, Figure 2-5

switch, 2.3, Figure 2-4, 3.1, Figure 3-1

requirements, A.2

PRTSC key, Table 4-1

Printer, connecting, 7.2

Prompt, system, 5.2

Reference books, B.1

Reset function, 4.6

RGB color monitor, G.1

RS-232C, 7.2

SCROLL LOCK key, Table 4-2
Self tests, 3.1-3.2
Serial number, 9.1
Service, 9.1-9.2
 during warranty, 9.2
 on-site after warranty, 9.2
Setting up computer, Chapter 2, 2.2-2.5
SHIFT key, Table 4-1
Shipping, 9.2
Software applications programs, 5.1
SPACE BAR key, Table 4-1
Specifications
 diskette, C.1
 TS 1605, A.1-A.3
Start-up procedures, 3.1-3.2
Switch
 rear panel, Figure 2-3, F.1
 power, 2.3, Figure 2-4, 3.1, Figure 3-1
 settings, Figure 2-3, F.1
 voltage, D.2

TAB key, Table 4-1
TeleDOS operating system, 3.3
Troubleshooting, 10.1
TS 1605
 description, 1.2
 specifications, A.1-A.3
Turning off the computer, 3.4

Video attributes, A.2
Voltage switch, D.2

Write-protecting diskettes, 6.4



 **TeleVideo Systems, Inc.**