



KN8 SLI

*AMD Athlon 64/64FX/64x2 Dual Core System Board
Socket 939*

User's Manual

Copyright and Warranty Notice

The information in this document is subject to change without notice and does not represent a commitment on part of the vendor, who assumes no liability or responsibility for any errors that may appear in this manual.

No warranty or representation, either expressed or implied, is made with respect to the quality, accuracy or fitness for any particular part of this document. In no event shall the manufacturer be liable for direct, indirect, special, incidental or consequential damages arising from any defect or error in this manual or product.

Product names appearing in this manual are for identification purpose only and trademarks and product names or brand names appearing in this document are the property of their respective owners.

This document contains materials protected under International Copyright Laws. All rights reserved. No part of this manual may be reproduced, transmitted or transcribed without the expressed written permission of the manufacturer and authors of this manual.

If you do not properly set the motherboard settings, causing the motherboard to malfunction or fail, we cannot guarantee any responsibility.

Table of Contents

Chapter 1. Introduction	1-1
1-1. Features & Specifications	1-1
1-2. Layout Diagram	1-3
Chapter 2. Hardware Setup.....	2-1
2-1. Install The Motherboard.....	2-1
2-2. Install CPU, Heatsink and Fan Assembly	2-2
2-3. Install System Memory	2-4
2-4. Install Graphics Card(s).....	2-6
(1). Normal Mode:	2-6
(2). SLI Mode:	2-7
2-5. Connectors, Headers and Switches	2-9
(1). ATX Power Input Connectors	2-9
(2). FAN Power Connectors	2-10
(3). CMOS Memory Clearing Header	2-11
(4). Front Panel Switches & Indicators Headers	2-12
(5). Additional USB Port Headers	2-13
(6). Wake-up Header	2-14
(7). Floppy and IDE Disk Drive Connectors	2-15
(8). Serial ATA Connectors	2-16
(9). Status Indicators	2-16
(10). PCI Express x16 Slot	2-17
(11). PCI Express x1 Slots.....	2-17
(12). Front Panel Audio Connection Header	2-18
(13). Internal Audio Connectors	2-19
(14). Back Panel Connectors	2-20
Chapter 3. BIOS Setup.....	3-1
3-1. SoftMenu Setup.....	3-2
3-2. Standard CMOS Features.....	3-4
3-3. Advanced BIOS Features.....	3-7
3-4. Advanced Chipset Features.....	3-9
3-5. Integrated Peripherals	3-12
3-6. Power Management Setup	3-16
3-7. PnP/PCI Configurations.....	3-18

3-8.	PC Health Status	3-20
3-9.	Load Fail-Safe Defaults	3-22
3-10.	Load Optimized Defaults	3-22
3-11.	Set Password	3-22
3-12.	Save & Exit Setup	3-22
3-13.	Exit Without Saving.....	3-22
<i>Appendix A.</i>	<i>Install nVidia nForce Chipset Driver</i>	<i>A-1</i>
<i>Appendix B.</i>	<i>Install Realtek Audio Driver.....</i>	<i>B-1</i>
<i>Appendix C.</i>	<i>Install Cool'n'Quiet Driver</i>	<i>C-1</i>
<i>Appendix D.</i>	<i>Install USB 2.0 Driver</i>	<i>D-1</i>
<i>Appendix E.</i>	<i>ABIT EQ (The Hardware Doctor Utility)</i>	<i>E-1</i>
<i>Appendix F.</i>	<i>FlashMenu (BIOS Update Utility).....</i>	<i>F-1</i>
<i>Appendix G.</i>	<i>NVRaid Floppy Disk</i>	<i>G-1</i>
<i>Appendix H.</i>	<i>Troubleshooting (Need Assistance?).....</i>	<i>H-1</i>
<i>Appendix I.</i>	<i>How to Get Technical Support</i>	<i>I-1</i>

Chapter 1. Introduction

1-1. Features & Specifications

1. CPU

- Supports AMD Athlon 64/64FX/64x2 Dual Core 939-pin K8 CPU with 2GHz system bus using Hyper Transport Technology
- Supports AMD K8 CPU Cool 'n' Quiet Technology

2. Memory

- Four 184-pin DIMM sockets
- Supports Dual channel DDR 400 ECC/non-ECC un-buffered memory
- Supports maximum memory capacity up to 4GB

3. Chipset

- NVIDIA nForce4 SLI single chip

4. NVIDIA SLI Technology

- Two PCI-Express X16 slots support NVIDIA Scalable Link Interface
- Increase bandwidth of the PCI Express™ bus providing 60x the bandwidth of PCI

5. ABIT Engineered

- ABIT Silent OTES II
- ABIT CPU ThermalGuard™ Technology
- ABIT SoftMenu™ Technology

6. NV SATAII 3Gb/s RAID

- Supports SATA RAID 0/1/0+1
- Support SATAII 3Gb/s data transfer rate.
- Supports SATA AHCI, providing native command queuing and native hot plug

7. Audio

- 7.1-channel Audio on Board (ALC850)
- Optical S/PDIF Output
- Supports auto jack sensing

8. NV GbE LAN

- NVIDIA Gigabit Ethernet Controller

9. IEEE 1394

- Supports IEEE 1394 at 100/200/400 Mb/s transfer rate

10. NV Firewall

- Native NVIDIA Firewall

11. Internal I/O Connectors

- 2x PCI-E X16 slot
- 3x PCI-E X1 slots
- 2x PCI slots
- 1x Floppy port supports up to 2.88MB
- 2x Ultra DMA 133/100/66/33 IDE connectors
- 4x SATA 3G connectors
- 3x USB 2.0 headers
- 1x IEEE 1394 header
- 1 x FP-Audio header,
- 1 x CD-IN

12. Back Panel I/O

- 1x PS/2 keyboard
- 1x PS/2 mouse
- 1 x OPT-OUT1 Connector
- 1x AUDIO1 connector (Surround-Left / Surround-Right, Rear-Left / Rear-Right, Center/Subwoofer)
- 1x AUDIO2 connector (Mic-In, Line-In, Line-Out)
- 4x USB 2.0,
- 1x RJ-45 LAN Connector
- 1 x IEEE1394 port

13. Miscellaneous

- ATX form factor: 305 x 245 mm

*** Specifications and information contained herein are subject to change without notice.**

1-2. Layout Diagram

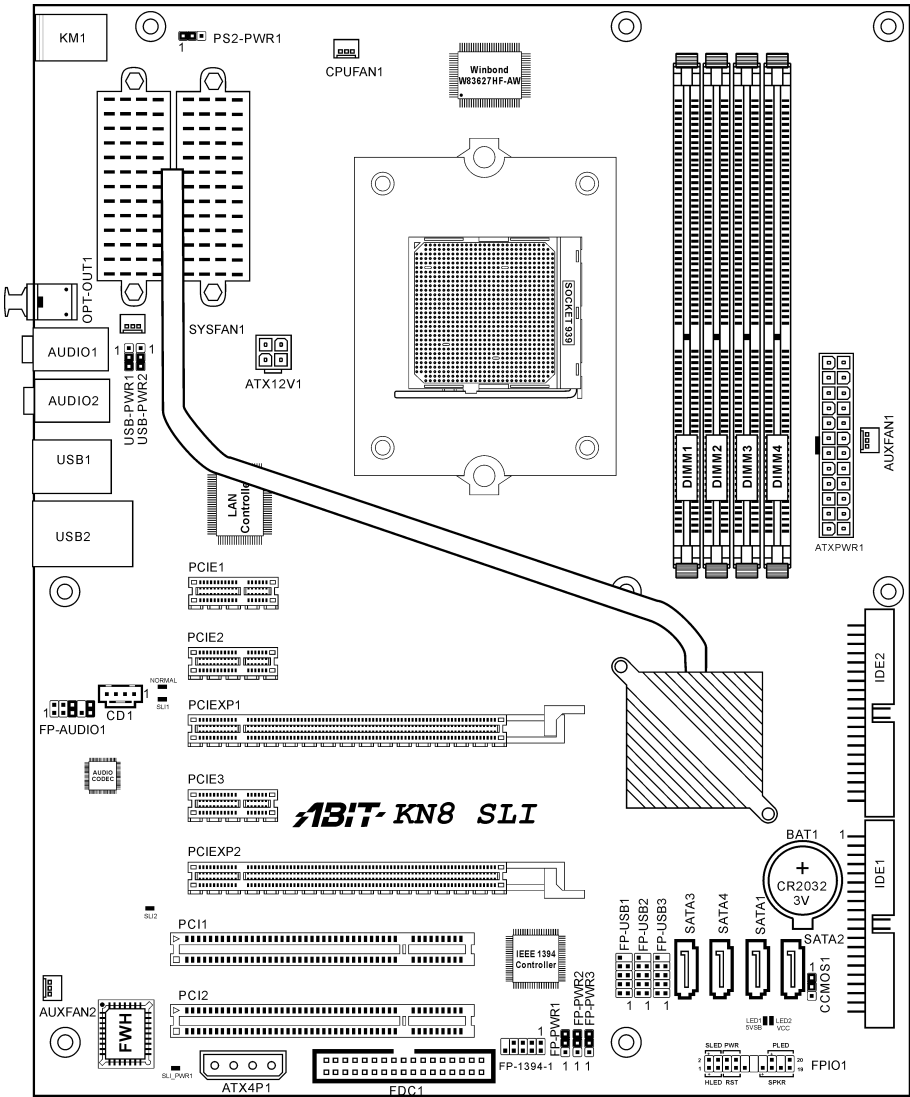



Chapter 2. Hardware Setup

Before the Installation: Turn off the power supply switch (fully turn off the +5V standby power), or disconnect the power cord before installing or unplugging any connectors or add-on cards. Failing to do so may cause the motherboard components or add-on cards to malfunction or damaged.

2-1. Install The Motherboard

Most computer chassis have a base with many mounting holes to allow a motherboard to be securely attached and at the same time, prevented from short circuits. There are two ways to attach the motherboard to the chassis base:

1. use with studs
2. or use with spacers

In principle, the best way to attach the board is to studs. Only if you are unable to do this should you attach the board with spacers. Line up the holes on the board with the mounting holes on the chassis. If the holes line up and there are screw holes, you can attach the board with studs. If the holes line up and there are only slots, you can only attach with spacers. Take the tip of the spacers and insert them into the slots. After doing this to all the slots, you can slide the board into position aligned with slots. After the board has been positioned, check to make sure everything is OK before putting the chassis back on.

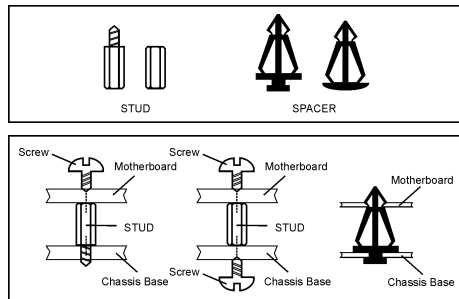

ATTENTION: To prevent shorting the PCB circuit, please REMOVE the metal studs or spacers if they are already fastened on the chassis base and are without mounting-holes on the motherboard to align with.

2-2. Install CPU, Heatsink and Fan Assembly

Please pay attention to the following notices before installing the CPU and heatsink/fan assembly.

1. Always use the processor with the Heatsink and Fan Assembly installed.
2. Do not touch the pins on the processor.
3. If you ever need to reinstall the Heatsink and fan Assembly, please clean the heatsink surface and apply new thermal interface material first.

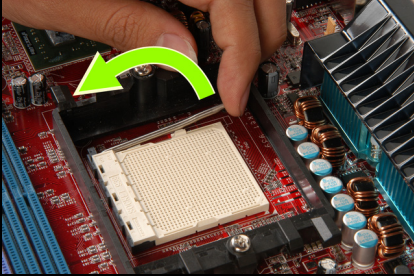

1. Pull out the socket locking lever slightly, then lift it up.

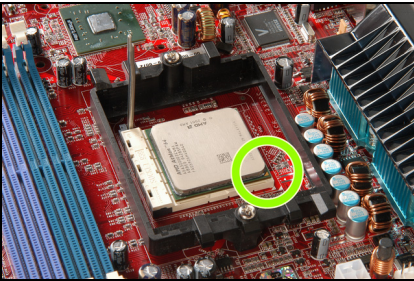

2. Align the corner with triangle mark of the processor with the marking on the motherboard, and then place the processor vertical down into the socket.

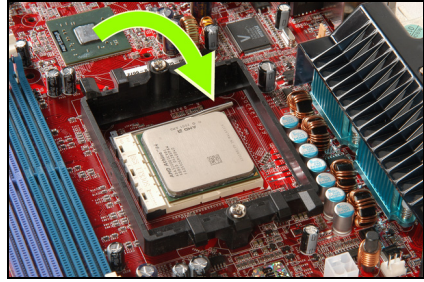

3. Lower the locking lever to the fully locked position.

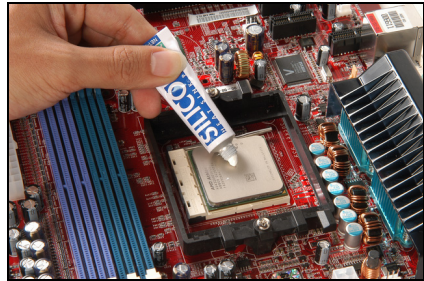

4. Apply thermal interface material.

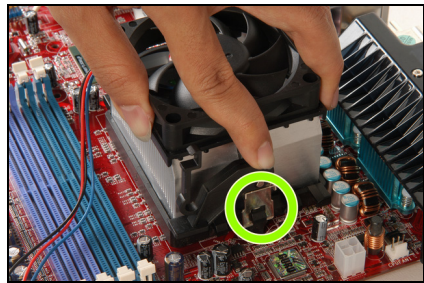

5. Place the heatsink and fan assembly onto the retention frame. Match the heatsink clip with the socket mounting lug. Hook the spring clip to the mounting lug.

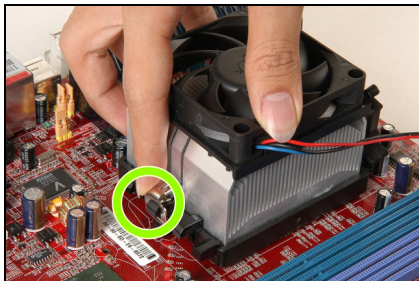

6. On the other side, push the retention clip straight down to lock into the plastic lug on the retention frame.

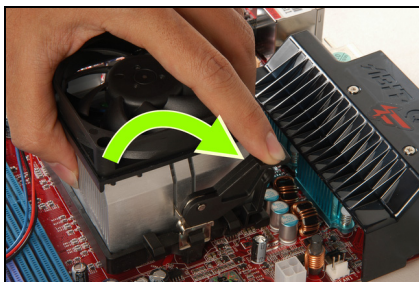

7. Turn the cam lever to lock into the retention frame.

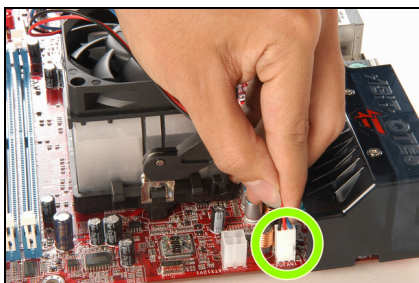

8. Attach the four-pin power plug from the heatsink and fan assembly to the CPU FAN connector.

For detailed information on how to install your heatsink and fan assembly, please refer to the instruction manual that came packed with the heatsink and fan assembly you bought.

2-3. Install System Memory

This motherboard provides four 184-pin DDR DIMM slots for Single/Dual Channel DDR 400/333/266 memory modules with memory expansion size up to 4GB.

Table 2-1. Valid Memory Configurations

Bank	Memory Module	Total Memory
Bank 0, 1 (DIMM1)	256, 512MB, 1GB	256MB ~ 1GB
Bank 2, 3 (DIMM2)	256, 512MB, 1GB	256MB ~ 1GB
Bank 4, 5 (DIMM3)	256, 512MB, 1GB	256MB ~ 1GB
Bank 6, 7 (DIMM4)	256, 512MB, 1GB	256MB ~ 1GB
Total System Memory		256MB ~ 4GB

Table 2-2. Unbuffered DIMM Support For AMD 939-pin Processor

Data Bus	DIMM1	DIMM2	DIMM3	DIMM4	Default Setting
64-bits (Single Channel)	Single rank	N/A	Empty	N/A	DDR400
	Double rank	N/A	Empty	N/A	DDR400
	Empty	N/A	Single rank	N/A	DDR333
	Empty	N/A	Double rank	N/A	DDR400
	Single rank	N/A	Single rank	N/A	DDR333
	Single rank	N/A	Double rank	N/A	DDR200
	Double rank	N/A	Single rank	N/A	DDR200
	Double rank	N/A	Double rank	N/A	DDR200
128-bits (Dual Channel)	Single rank	Single rank	Empty	Empty	DDR400
	Double rank	Double rank	Empty	Empty	DDR400
	Empty	Empty	Single rank	Single rank	DDR333
	Empty	Empty	Double rank	Double rank	DDR400
	Single rank	Single rank	Single rank	Single rank	DDR333
	Single rank	Single rank	Double rank	Double rank	DDR200
	Double rank	Double rank	Single rank	Single rank	DDR200
	Double rank	Double rank	Double rank	Double rank	DDR200

To reach the performance of Dual Channel DDR, the following rules must be obeyed:

- **When installing TWO DIMM modules:** Install DIMM modules of the same type and size for slots [DIMM1]+[DIMM2] or slots [DIMM3]+[DIMM4].
- **When installing FOUR DIMM modules:** Install DIMM modules of the same type and size for slots [DIMM1]+[DIMM2], and slots [DIMM3]+[DIMM4].

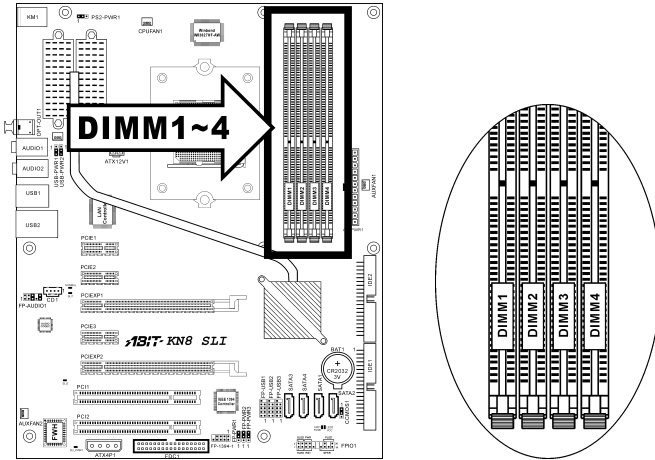

NOTE: Usually there is no hardware or BIOS setup requires after adding or removing memory modules, but you will have to clear the CMOS memory first if any memory module related problem occurs.

Power off the computer and unplug the AC power cord before installing or removing memory modules.

1. Locate the DIMM slot on the board.
2. Hold two edges of the DIMM module carefully, keep away of touching its connectors.
3. Align the notch key on the module with the rib on the slot.
4. Firmly press the module into the slots until the ejector tabs at both sides of the slot automatically snaps into the mounting notch. Do not force the DIMM module in with extra force as the DIMM module only fit in one direction.

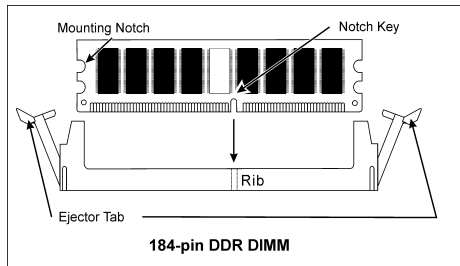

5. To remove the DIMM modules, push the two ejector tabs on the slot outward simultaneously, and then pull out the DIMM module.

ATTENTION: Static electricity can damage the electronic components of the computer or optional boards. Before starting these procedures, ensure that you are discharged of static electricity by touching a grounded metal object briefly.

2-4. Install Graphics Card(s)

This motherboard supports two graphics modes: Normal Mode for single PCIE graphics card and SLI Mode for two identical SLI-ready graphics cards.

NOTE: The NVIDIA SLI technology currently supports the Windows XP operating system only.

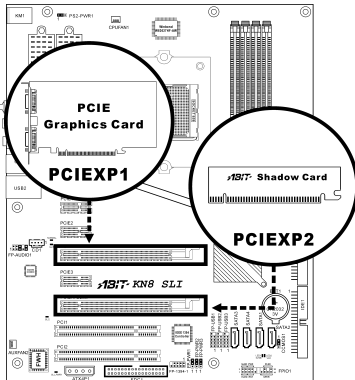

Normal Mode: Insert your PCIE graphics card into PCIEXP1 slot, and the ABIT Shadow Card into PCIEXP2 Slot.

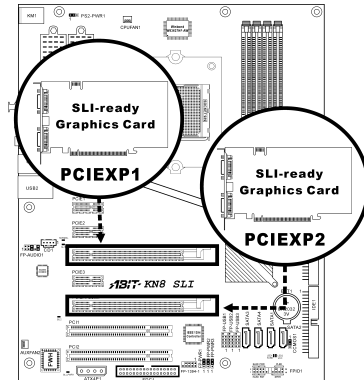

SLI Mode: Insert 2 identical SLI-ready graphics cards into PCIEXP1 and PCIEXP2 slots.

(1). Normal Mode:

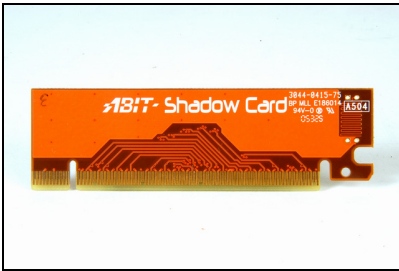

1. Locate ABIT Shadow Card in the package.

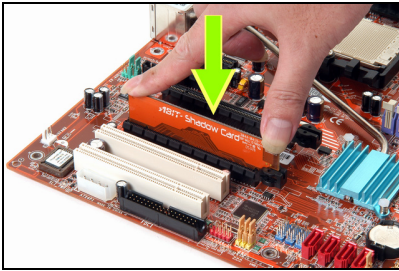

2. Insert ABIT Shadow Card into PCIEXP2 slot.

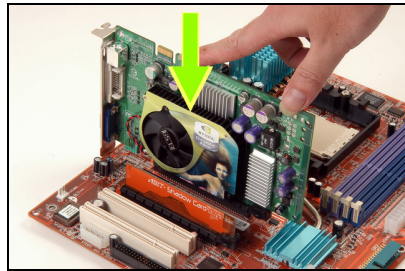

3. Insert a PCIE graphics card into PCIEXP1 slot.

NOTE: Be sure to insert your ABIT Shadow Card into PCIEXP2 slot, do not switch it with the graphics card.

(2). SLI Mode:

To install two SLI-ready graphics cards under SLI Mode, you will need to:

- Prepare two identical NVIDIA certified, SLI-ready PCI Express x16 graphics cards (the same model from the same manufacturer).
- Make sure the graphics card driver supports the NVIDIA SLI technology. Download the latest driver from NVIDIA website (www.nvidia.com).
- Make sure your power supply unit is sufficient to provide the minimum power required.

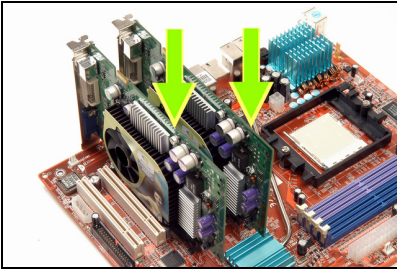

1. Insert the two graphics cards into PCIEXP1 and PCIEXP2 slots on the motherboard.

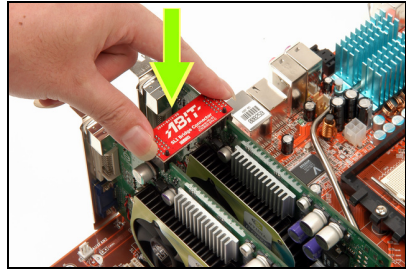

4. Insert the SLI Bridge Connector into the SLI goldfingers on each graphics card.

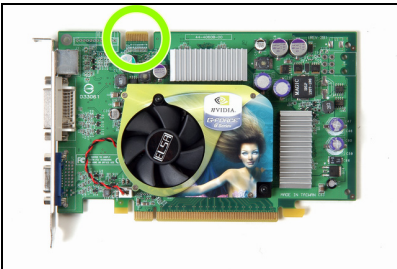

2. There are goldfingers on your SLI Graphics Cards reserved for the SLI Bridge Connector.



5. The SLI bracket included in the package is used for supporting the SLI bridge connector and the two SLI graphics cards.

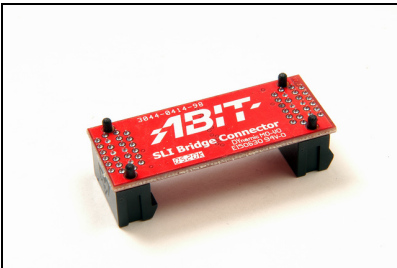

3. Locate the SLI Bridge Connector in the package.

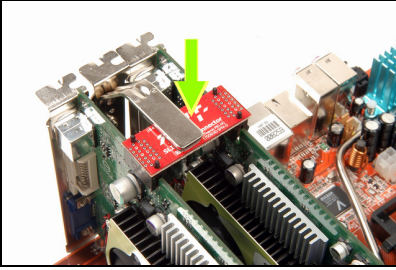

6. Insert the SLI bracket into the bracket slot between the graphics cards. Secure the SLI bracket and the graphics cards to the chassis with screws.

NOTE: The OTES SLIstream that packed in the package is optional. Please refer to the Quick Installation Guide of the OTES SLIstream if you wish to install it.

IMPORTANT: Please disable the following items in BIOS setup while running under SLI mode: All the “**FanEQ controls**” (CPU, NB, SYS, OTES1, OTES2 and AUX FanEQ Control) and “**Cool 'n' Quiet Technology**”. The system may be unstable without doing so. Detail information about these items will be described in “**Chapter 3. BIOS Setup**”.

2-5. Connectors, Headers and Switches

Here we will show you all of the connectors, headers and switches, and how to connect them. Please read the entire section for necessary information before attempting to finish all the hardware installation inside the computer chassis. A complete enlarged layout diagram is shown in Chapter 1 for all the positions of connectors and headers on the board that you may refer to.

WARNING: Always power off the computer and unplug the AC power cord before adding or removing any peripheral or component. Failing to do so may cause severe damage to your motherboard and/or peripherals. Plug in the AC power cord only after you have carefully checked everything.

(1). ATX Power Input Connectors

This motherboard provides two power connectors to connect ATX12V power supplier.

NOTE: This 24-pin power connector “ATXPWR1” is compliant to the former 20-pin type. Pay attention to the orientation when attaching the power cord. (Pin-11, 12, 23, and 24 should be left un-connected).

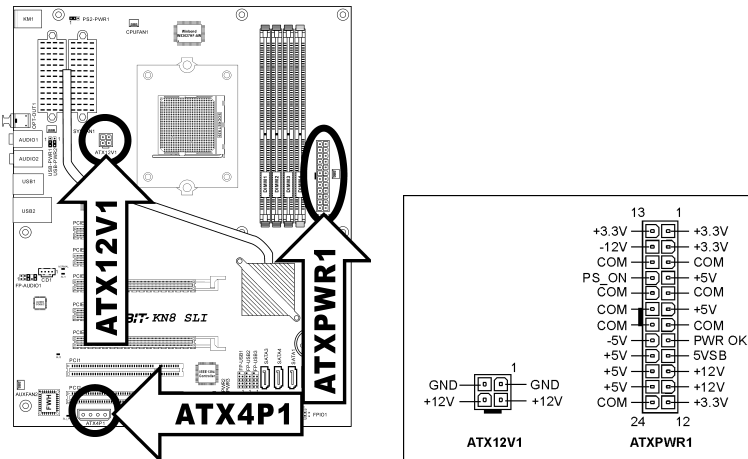

Note: It is recommended to connect to a power with 350W, 20A +5VDC capacity at least for heavily loaded system, and a 2A +5VSB capacity at least for supporting wake-up features.

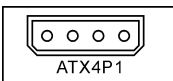

The auxiliary 12V power connector [ATX4P1] provides an additional power source for devices added on PCI Express slots. It is highly recommended to attach 12V power from the power supplier for the best system stability.

(2). FAN Power Connectors

These connectors each provide power to the cooling fans installed in your system.

- **CPUFAN1:** CPU Fan Power Connector
- **SYSFAN1:** System Fan Power Connector
- **AUXFAN1, AUXFAN2:** Auxiliary Fan Power Connector

WARNING: These fan connectors are not jumpers. DO NOT place jumper caps on these connectors.

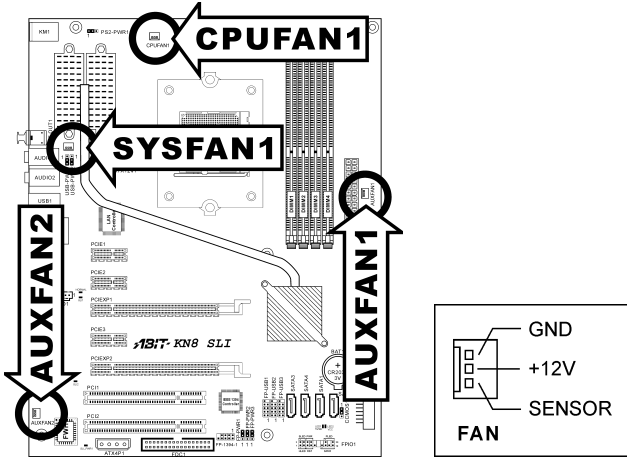

(3). CMOS Memory Clearing Header

This header uses a jumper cap to clear the CMOS memory.

- **Pin 1-2 shorted (default):** Normal operation.
- **Pin 2-3 shorted:** Clear CMOS memory.

WARNING: Turn the power off first (including the +5V standby power) before clearing the CMOS memory. Failing to do so may cause your system to work abnormally or malfunction.

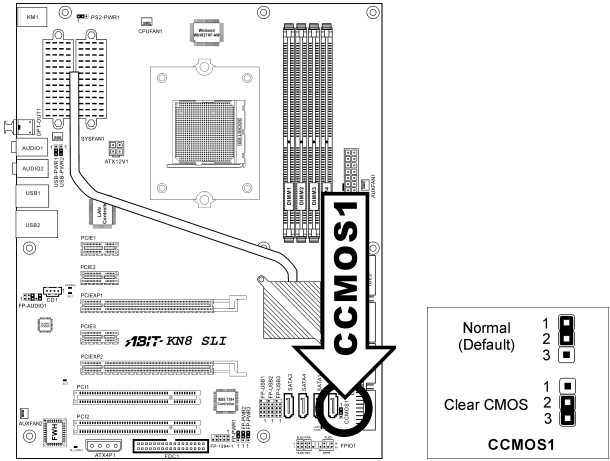

(4). Front Panel Switches & Indicators Headers

This header is used for connecting switches and LED indicators on the chassis front panel.

Watch the power LED pin position and orientation. The mark “+” aligning to the pin in the figure below stands for positive polarity for the LED connection. Please pay attention to connect these headers. A wrong orientation will simply cause the LED to not light, but a wrong connection of the switches could cause system malfunction.

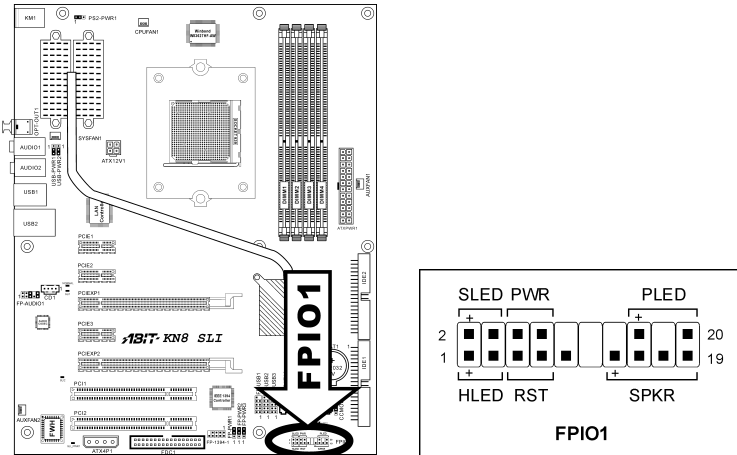

- **HLED (Pin 1, 3):**
Connects to the HDD LED cable of chassis front panel.
- **RST (Pin 5, 7):**
Connects to the Reset Switch cable of chassis front panel.
- **SPK (Pin 15, 17, 19, 21):**
Connects to the System Speaker cable of chassis.
- **SLED (Pin 2, 4):**
Connects to the Suspend LED cable (if there is one) of chassis front panel.
- **PWR-ON (Pin 6, 8):**
Connects to the Power Switch cable of chassis front panel.
- **PLED (Pin 16, 18, 20):**
Connects to the Power LED cable of chassis front panel.

(5). Additional USB Port Headers

These headers each provide 2 additional USB 2.0 ports connection through a USB cable designed for USB 2.0 specifications.

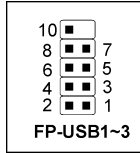
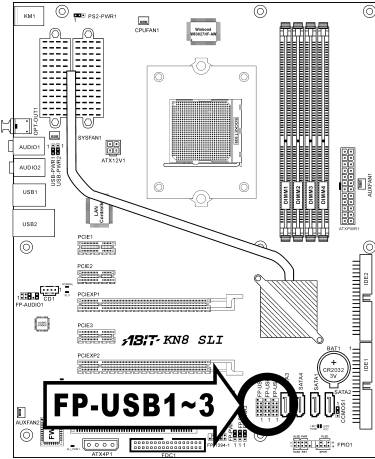

Pin	Pin Assignment	Pin	Pin Assignment
1	VCC	2	VCC
3	Data0 -	4	Data1 -
5	Data0 +	6	Data1 +
7	Ground	8	Ground
9	NC	10	NC

(6). Wake-up Header

These headers use a jumper cap to enable/disable the wake-up function.

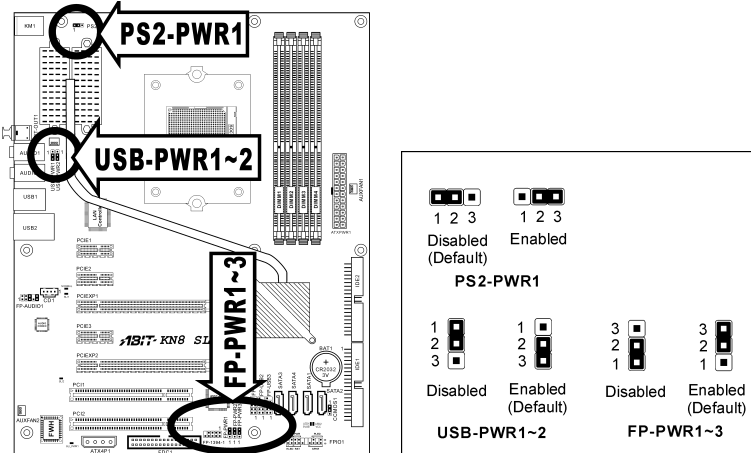

- PS2-PWR1:**
 Pin 1-2 shorted (Default): Disable wake-up function support at Keyboard/Mouse port.
 Pin 2-3 shorted: Enable wake-up function support at Keyboard/Mouse port.
- USB-PWR1:**
 Pin 1-2 shorted: Disable wake-up function support at USB1 port.
 Pin 2-3 shorted (default): Enable wake-up function support at USB1 port.
- USB-PWR2:**
 Pin 1-2 shorted: Disable wake-up function support at USB2 port.
 Pin 2-3 shorted (default): Enable wake-up function support at USB2 port.
- FP-PWR1:**
 Pin 1-2 shorted: Disable wake-up function support at FP-USB1 port.
 Pin 2-3 shorted (default): Enable wake-up function support at FP-USB1 port.
- FP-PWR2:**
 Pin 1-2 shorted: Disable wake-up function support at FP-USB2 port.
 Pin 2-3 shorted (default): Enable wake-up function support at FP-USB2 port.
- FP-PWR3:**
 Pin 1-2 shorted: Disable wake-up function support at FP-USB3 port.
 Pin 2-3 shorted (default): Enable wake-up function support at FP-USB3 port.

(7). Floppy and IDE Disk Drive Connectors

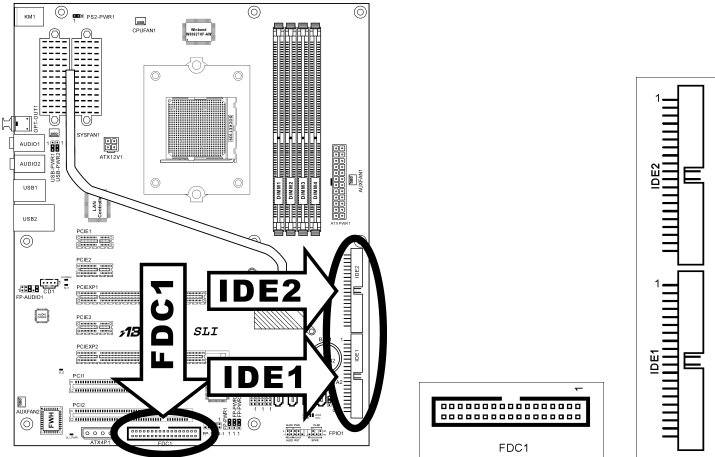

The FDC1 connector connects up to two floppy drives with a 34-wire, 2-connector floppy cable. Connect the single end at the longer length of ribbon cable to the FDC1 on the board, the two connectors on the other end to the floppy disk drives connector. Generally you need only one floppy disk drive in your system.

NOTE: The red line on the ribbon cable must be aligned with pin-1 on both the FDC1 port and the floppy connector.

Each of the IDE port connects up to two IDE drives at Ultra ATA/100 mode by one 40-pin, 80-conductor, and 3-connector Ultra ATA/66 ribbon cables.

Connect the single end (blue connector) at the longer length of ribbon cable to the IDE port of this board, the other two ends (gray and black connector) at the shorter length of the ribbon cable to the connectors of your hard drives.

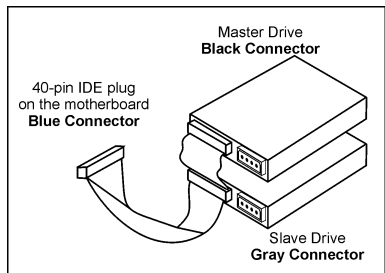

NOTE: Make sure to configure the “Master” and “Slave” relation before connecting two drives by one single ribbon cable. The red line on the ribbon cable must be aligned with pin-1 on both the IDE port and the hard-drive connector.

(8). Serial ATA Connectors

These connectors are provided to attach one Serial ATA device at each channel via Serial ATA cable.

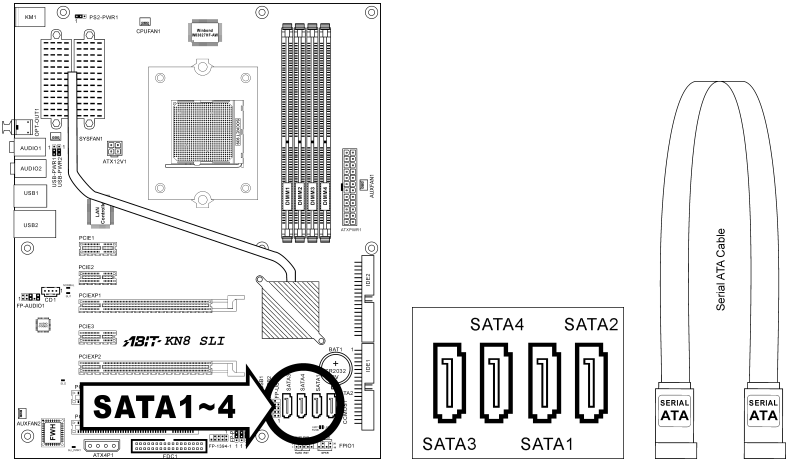

(9). Status Indicators

- **LED1 (5VSB):** This LED lights up when the power supply is connected with power source.
- **LED2 (VCC):** This LED lights up when the system power is on.
- **NORMAL:** This LED lights up when the system works under Normal Graphics Mode.
- **SLI:** This LED lights up when the system works under SLI Graphics Mode.
- **SLI_PWR1:** This LED lights up if the ATX4P1 connector is not connected to the power supplier when working under SLI Graphics Mode.

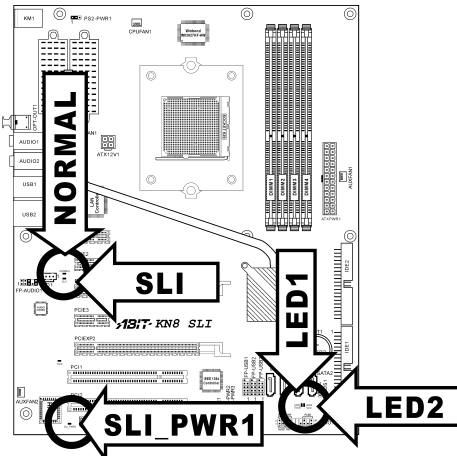

(10). PCI Express x16 Slot

This slot is used to attach the next generation of graphics architecture.

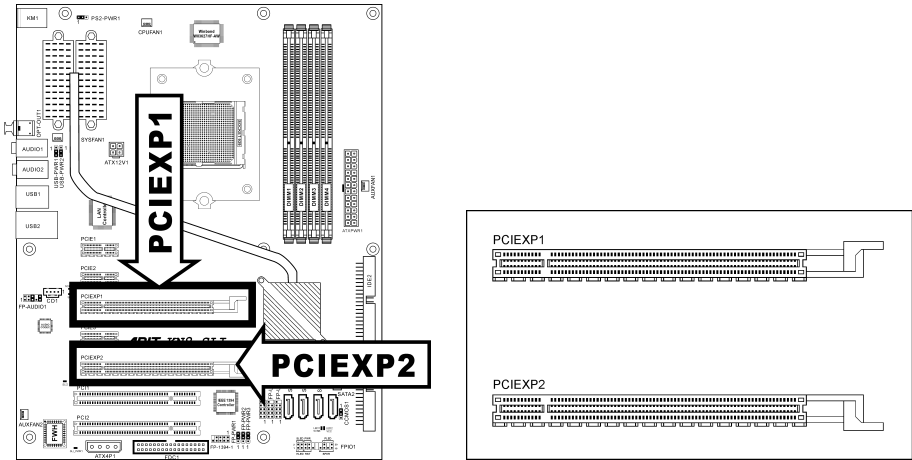

(11). PCI Express x1 Slots

These slots are used to attach the next generation of I/O architecture.

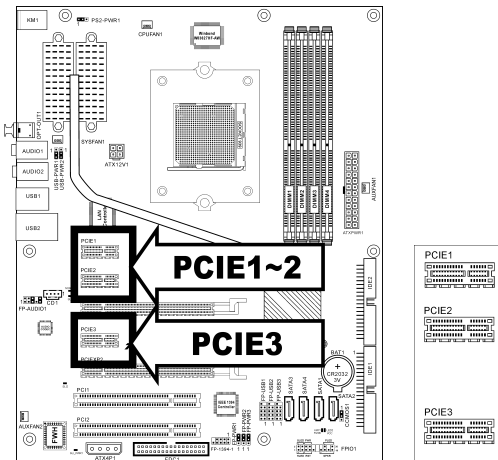

(12). Front Panel Audio Connection Header

This header provides the connection to audio connector at front panel.

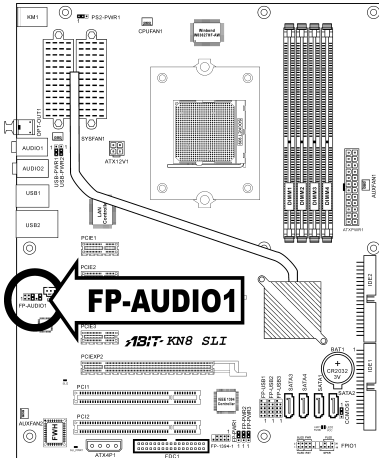

Pin	Pin Assignment	Pin	Pin Assignment
1	Audio Mic.	2	Ground
3	Audio Mic. Bias	4	VCC
5	Speaker Out Right Channel	6	Speaker Out Right Channel Return
7	X	8	NC
9	Speaker Out Left Channel	10	Speaker Out Left Channel Return

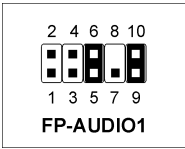

(13). Internal Audio Connectors

These connectors connect to the audio output of internal CD-ROM drive or add-on card.

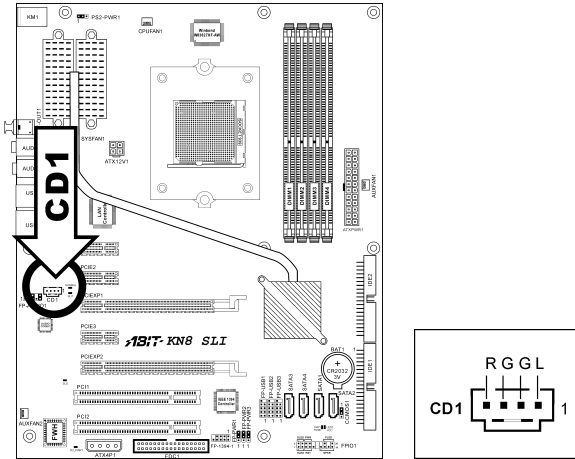

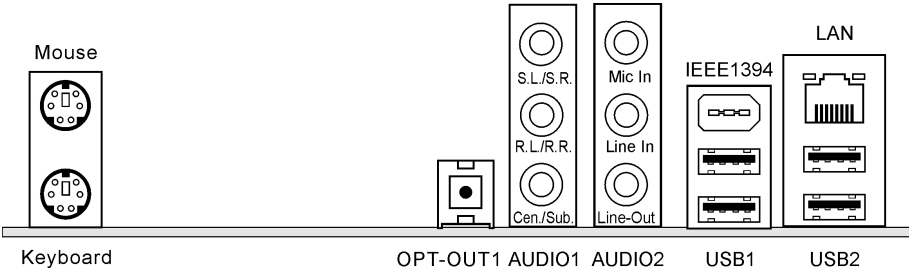
(14). Back Panel Connectors

- **Mouse:** Connects to PS/2 mouse.
- **Keyboard:** Connects to PS/2 keyboard.
- **OPT-OUT1:** This connector provides an S/PDIF-Out connection through optical fiber to digital multimedia devices.
- **AUDIO1:**
 - S.L./S.R. (Surround Left / Surround Right):** Connects to the surround left and surround right channel in the 7.1 channel audio system.
 - R.L./R.R. (Rear Left / Rear Right):** Connects to the rear left and rear right channel in the 7.1 channel audio system.
 - Cen./Sub. (Center / Subwoofer):** Connects to the center and subwoofer channel in the 7.1 channel audio system.
- **AUDIO2:**
 - Mic-In:** Connects to the plug from external microphone.
 - Line-In:** Connects to the line out from external audio sources.
 - Line-Out:** Connects to the front left and front right channel in the 7.1-channel or regular 2-channel audio system.
- **LAN1:** Connects to Local Area Network.
- **IEEE1:** Connects to devices of IEEE1394 protocol
- **USB1/USB2:** Connects to USB devices such as scanner, digital speakers, monitor, mouse, keyboard, hub, digital camera, joystick etc.

Chapter 3. BIOS Setup

This motherboard provides a programmable EEPROM that you can update the BIOS utility. The BIOS (Basic Input/Output System) is a program that deals with the basic level of communication between processor and peripherals. Use the BIOS Setup program only when installing motherboard, reconfiguring system, or prompted to “Run Setup”. This chapter explains the Setup Utility of BIOS utility.

After powering up the system, the BIOS message appears on the screen, the memory count begins, and then the following message appears on the screen:

PRESS DEL TO ENTER SETUP

If this message disappears before you respond, restart the system by pressing <Ctrl> + <Alt> + keys, or by pressing the Reset button on computer chassis. Only when it failed by these two methods can you restart the system by powering it off and then back on.

After pressing key, the main menu screen appears.

Phoenix - AwardBIOS CMOS Setup Utility	
<ul style="list-style-type: none"> ▶ SoftMenu Setup ▶ Standard CMOS Features ▶ Advanced BIOS Features ▶ Advanced Chipset Features ▶ Integrated Peripherals ▶ Power Management Setup ▶ PnP/PCI Configurations 	<ul style="list-style-type: none"> ▶ PC Health Status Load Fail-Safe Defaults Load Optimized Defaults Set Password Save & Exit Setup Exit Without Saving
<p>Esc : Quit F10 : Save & Exit Setup</p>	<p>↑ ↓ ← → : Select Item (NF-CK804-6K61FA1DC-00)</p>
<p>Change CPU's Clock & Voltage</p>	

NOTE: In order to increase system stability and performance, our engineering staffs are constantly improving the BIOS menu. The BIOS setup screens and descriptions illustrated in this manual are for your reference only and may not completely match what you see on your screen.

In the BIOS Setup main menu, you can see several options. We will explain these options step by step in the following pages of this chapter, but let us first see a short description of the function keys you may use here.

Esc:

Press this button to quit the BIOS Setup.

↑ ↓ ← →:

Press these buttons to choose, in the main menu, the option you want to confirm or to modify.

F10:

When you have completed the setup of BIOS parameters, press this button to save these parameters and to exit the BIOS Setup menu.

3-1. SoftMenu Setup

The SoftMenu utility is ABIT's exclusive and ultimate solution in programming the CPU operating speed. All the parameters regarding CPU FSB speed, multiplier factor, the AGP & PCI clock, and even the CPU core voltage are all available at your fingertips.

Phoenix - AwardBIOS CMOS Setup Utility		Item Help
SoftMenu Setup		
AMD Athlon(tm) 64 Processor 3400+		
Frequency : 2200MHz		
CPU Operating Speed	Default	
X - CPU FSB Clock(MHz)	200	
X - Multiplier Factor	11x	
X - PCIE Clock	100Mhz	
Voltages Control		Default
X - CPU Core Voltage	1.500 V	
X - DDR RAM Voltage	2.60 V	
X - DDR Ref Voltage	- 60mV	
X - nForce4 Voltage	1.50 V	
X - Hypertransport Voltage	Default	
↑↓:Move Enter:Select +/-/PU/PD:Value F10:Save ESC:Exit F1:General Help F5: Previous Values F6: Fail-Safe Defaults F7: Optimized Defaults		

AMD Athlon(tm) 64 Processor 3400+:

This item displays the CPU model name installed on this motherboard.

Frequency:

This item displays the CPU internal clock speed.

CPU Operating Speed:

This item displays the CPU operating speed according to the type and speed of your CPU. You can also select the [User Define] option to enter the manual option.

User Define:

WARNING: The wrong settings of the multiplier and external clock in certain circumstances may cause CPU damage. Setting the working frequency higher than the PCI chipset or processor specs, may cause abnormal memory module functioning, system hangs, hard disk drive data lose, abnormal functioning of the VGA card, or abnormal functioning with other add-on cards. Using non-specification settings for your CPU is not the intention of this explanation. These should be used for engineering testing, not for normal applications.

There will be no guaranty for the settings beyond specification, any damage of any component on this motherboard or peripherals result therein is not our responsibility.

*** CPU FSB Clock(MHz):**

This item selects the external clock frequency. Due to the specification limit of the CPU you installed, the speed you set over its standard bus speed is supported, but not guaranteed.

*** Multiplier Factor:**

This item displays the multiplier factor for the CPU you installed.

*** PCIE Clock:**

This item selects the PCI Express frequency.

Voltage Control:

This option allows you to switch between the default and user-defined voltages. Leave this setting to default unless the current voltage setting cannot be detected or is not correct. The option “**User Define**” enables you to select the following voltages manually.

*** CPU Core Voltage:**

This item selects the CPU core voltage.

*** DDR RAM Voltage:**

This item selects the voltage for DRAM slot.

*** DDR Ref Voltage:**

This item selects the reference voltage needed for DRAM slot to increase its conformity.

*** nForce4 Voltage:**

This item selects the NB voltage.

*** HyperTransport Voltage:**

This item selects the voltage for LDT Bus.

ATTENTION: A wrong voltage setting may cause the system unstable or even damage the CPU. Please leave it to default settings unless you are fully aware of its consequences.

3-2. Standard CMOS Features

This section contains the basic configuration parameters of the BIOS. These parameters include date, hour, VGA card, FDD and HDD settings.

Phoenix - Award WorkstationBIOS CMOS Setup Utility		
Standard CMOS Features		
Date (mm:dd:yy)	Thu. Jan 1 2005	Item Help
Time (hh:mm:ss)	12 : 34 : 56	
▶ IDE Channel 1 Master	None	
▶ IDE Channel 1 Slave	None	
▶ IDE Channel 2 Master	None	
▶ IDE Channel 2 Slave	None	
▶ IDE Channel 3 Master	None	
▶ IDE Channel 4 Master	None	
▶ IDE Channel 5 Master	None	
▶ IDE Channel 6 Master	None	
Drive A	1.44M, 3.5 in.	
Drive B	None	
Floppy 3 Mode Support	Disabled	
Halt On	All, But keyboard	
Base Memory	640K	
Extended Memory	1046520K	
Total Memory	1047552K	
↑ ↓ : Move Enter : Select +/- /PU/PD : Value F10 : Save ESC : Exit F1 : General Help F5 : Previous Values F6 : Fail-Safe Defaults F7 : Optimized Defaults		

Date (mm:dd:yy):

This item sets the date you specify (usually the current date) in the format of [Month], [Date], and [Year].

Time (hh:mm:ss):

This item sets the time you specify (usually the current time) in the format of [Hour], [Minute], and [Second].

☛ **IDE Channel 1 Master/Slave, IDE Channel 2 Master/Slave, IDE Channel 3 Master, IDE Channel 4 Master, IDE Channel 5 Master, IDE Channel 6 Master:**

Click <Enter> key to enter its submenu:

Phoenix - Award WorkstationBIOS CMOS Setup Utility		
IDE Channel 1 Master		
IDE HDD Auto-Detection	Press Enter	Item Help
IDE Channel 1 Master	Auto	
Access Mode	Auto	
Capacity	0 MB	
Cylinder	0	
Head	0	
Precomp	0	
Landing Zone	0	
Sector	0	

↑ ↓ :Move Enter:Select +/-/PU/PD:Value F10:Save ESC:Exit F1:General Help
 F5: Previous Values F6: Fail-Safe Defaults F7: Optimized Defaults

IDE HDD Auto-Detection:

This item allows you to detect the parameters of IDE drives by pressing <Enter> key. The parameters will be shown on the screen automatically.

IDE Channel 1 Master/Slave, IDE Channel 2 Master/Slave, IDE Channel 3 Master, IDE Channel 4 Master, IDE Channel 5 Master, IDE Channel 6 Master:

When set to [Auto], the BIOS will automatically check what kind of IDE drive you are using. If you want to define your own drive by yourself, set it to [Manual] and make sure you fully understand the meaning of the parameters. Please refer to the instruction manual provided by the device’s manufacturer to get the setting right.

Access Mode:

This item selects the mode to access your IDE devices. Leave this item to its default [Auto] setting to detect the access mode of your HDD automatically.

Capacity:

This item displays the approximate capacity of the disk drive. Usually the size is slightly greater than the size of a formatted disk given by a disk-checking program.

Cylinder:

This item configures the number of cylinders.

Head:

This item configures the number of read/write heads.

Precomp:

This item displays the number of cylinders at which to change the write timing.

Landing Zone:

This item displays the number of cylinders specified as the landing zone for the read/write heads.

Sector:

This item configures the number of sectors per track.

↶ Back to Standard CMOS Features Setup Menu:

Drive A & Drive B:

This item sets the type of floppy drives (usually only Drive A) installed.

Floppy 3 Mode Support:

This item allows you to use “3 Mode Floppy Drive” in Japanese computer system by selecting drive A, B, or both. Leave this item to its default [Disabled] setting if you are not using this Japanese standard floppy drive.

Halt On:

This item determines whether the system stops if an error is detected during system boot-up.

[All Errors]: The system-boot will stop whenever the BIOS detect a non-fatal error.

[No Errors]: The system-boot will not stop for any error detected.

[All, But Keyboard]: The system-boot will stop for all errors except a keyboard error.

[All, But Diskette]: The system-boot will stop for all errors except a diskette error.

[All, But Disk/Key]: The system-boot will stop for all errors except a diskette or keyboard error.

Base Memory:

This item displays the amount of base memory installed in the system. The value of the base memory is typically 640K for system with 640K or more memory size installed on the motherboard.

Extended Memory:

This item displays the amount of extended memory detected during system boot-up.

Total Memory:

This item displays the total memory available in the system.

3-3. Advanced BIOS Features

Phoenix - Award Workstation BIOS CMOS Setup Utility		
Advanced BIOS Features		
		Item Help
Quick Power on Self Test	Enabled	
▶ Hard Disk Boot Priority	Press Enter	
First Boot Device	Floppy	
Second Boot Device	Hard Disk	
Third Boot Device	CDROM	
Boot Other Device	Enabled	
Boot Up Floppy Seek	Disabled	
Boot Up NumLock Status	On	
Security Option	Setup	
MPS Version Ctrl For OS	1.4	
Delay For HDD (Secs)	0	
Full Screen Logo Show	Enabled	
↑ ↓ : Move Enter : Select +/- /PU/PD : Value F10 : Save ESC : Exit F1 : General Help F5 : Previous Values F6 : Fail-Safe Defaults F7 : Optimized Defaults		

Quick Power On Self Test:

When set to [Enabled], this item speeds up the Power On Self Test (POST) after powering on the system. The BIOS shorten or skip some check during the POST.

Hard Disk Boot Priority:

This item selects the hard disks booting priority. By pressing <Enter> key, you can enter its submenu where the hard disks detected can be selected for the booting sequence to boot up system.

This item functions only when there is the option of [Hard Disk] in any one of the First/Second/Third Boot Device items.

First Boot Device / Second Boot Device / Third Boot Device / Boot Other Device:

Select the drive to boot first, second and third in the [First Boot Device], [Second Boot Device], and [Third Boot Device] items respectively. The BIOS will boot the operating system according to the sequence of the drive selected. Set [Boot Other Device] to [Enabled] if you wish to boot from another device other than these three items.

Boot Up Floppy Seek:

When the computer boots up, the BIOS detects if the system has a FDD or not. When this item is set to *Enabled*, if the BIOS detects no floppy drive, it will display a floppy disk drive error message. If this item is disabled, the BIOS will skip this test. The default setting is *Disabled*.

Boot Up NumLock Status:

This item determines the default state of the numeric keypad at system booting up.

[On]: The numeric keypad functions as number keys.

[Off]: The numeric keypad functions as arrow keys.

Security Option:

This item determines when the system will prompt for password - every time the system boots or only when it enters the BIOS setup.

[Setup]: The password is required only when accessing the BIOS Setup.

[System]: The password is required each time the computer boots up.

To disable security, select *Set Password* at main menu and then you will be asked to enter the password. Do not type anything and just press the <Enter> key and it will disable security. Once security is disabled, the system will boot and you can enter the *BIOS setup menu* freely.

NOTE: Don't forget your password. If you forget the password, you will have to open the computer case and clear all information in the CMOS before you can start up the system. But by doing this, you will have to reset all previously set options.

MPS Version Ctrl For OS:

This item specifies which version of MPS (Multi-Processor Specification) this motherboard will use. Leave this item to its default setting.

Delay For HDD (Secs):

This item allows the BIOS to support some old or special IDE devices by prolonging this delay time. A larger value will give more delay time to the device for which to initialize and to prepare for activation.

Full Screen LOGO Show:

This item determines to show the full screen logo when booting.

3-4. Advanced Chipset Features

Phoenix - Award WorkstationBIOS CMOS Setup Utility Advanced Chipset Features		
HT Frequency	AUTO	Item Help
▶ DRAM Configuration	Press Enter	
SSE/SSE2 Instructions	Enable	
System BIOS Cachable	Disable	
↑ ↓ : Move Enter: Select +/-/PU/PD: Value F10: Save ESC: Exit F1: General Help F5: Previous Values F6: Fail-Safe Defaults F7: Optimized Defaults		

HT Frequency:

This item selects the LDT Bus Frequency.

↳ DRAM Configuration:

Click <Enter> key to enter its submenu:

Phoenix - Award WorkstationBIOS CMOS Setup Utility DRAM Configuration		
DRAM Timing Selectable	Auto	Item Help
X - DRAM Clock	Auto	
X - CAS latency Time	Auto	
X - Row Cycle Time	Auto	
X - Row Refresh Cycle Time	Auto	
X - Min RAS# Active time	Auto	
X - RAS# to CAS# delay	Auto	
X - RAS# Precharge Time	Auto	
X - RAS# to RAS# delay	Auto	
X - Write Recovery Time	Auto	
X - Write to Read Delay	Auto	
X - Read to Write Delay	Auto	
X - DRAM Command rate	Auto	
X - Read Preamble value	Auto	
X - Max. Async Latency value	Auto	
X - Bank Interleaving	Enabled	
X - Burst Length	4 beats	
X - DRAM Drive Strength	Drive	
X - Force 64-bit mode always	Disabled	
X - R/W Queue Bypass Counter.	8	
X - Bypass Max	4	
X - Idle Cycle Limit(ILD-Lmt)	16 Cycles	
X - Dynamic Idle Cycle Count.	Enabled	
MTRR mapping mode	Continuous	
32 bit Dram Memory Hole	Auto	
↑ ↓ : Move Enter: Select +/-/PU/PD: Value F10: Save ESC: Exit F1: General Help F5: Previous Values F6: Fail-Safe Defaults F7: Optimized Defaults		

DRAM Timing Selectable:

This item selects the DRAM timing mode. When set to “**By SPD**”, the BIOS will read the DRAM module SPD data and automatically set to the values stored in it. Leave this item to its default “**Auto**” setting.

*** DRAM Clock:**

This item sets the DRAM clock of your DRAM module. The system may be unstable or unable to boot up if your DRAM module does not support the clock you set.

When set to [By SPD], the BIOS will read the DRAM module SPD data and automatically set the DRAM clock by the value stored in it.

*** CAS Latency Time:**

You can select SDRAM CAS (Column Address Strobe) latency time according your SDRAM specification.

*** Row Cycle Time:**

This item specifies the RAS# active to RAS# active time or auto refresh time of the same bank.

*** Row Refresh Cycle Time:**

This item specifies the auto refresh active to RAS# active time or RAS# auto refresh time.

*** Min. RAS# Active Time:**

This item specifies the minimum RAS# active time.

*** RAS# to CAS# Delay:**

This item specifies the RAS# active to CAS# read write delay time to the same bank.

*** RAS# Precharge Time:**

This item specifies the RAS# precharge time.

*** RAS# to RAS# Delay:**

This item specifies the RAS# active to RAS# active delay time of different bank.

*** Write Recovery Time:**

This item specifies the time measured from the last write datum is safely registered by the DRAM.

*** Write to Read Delay:**

This item specifies the time measured from the rising edge following the last non-masked data strobe to the rising edge of the next read command.

*** Read to Write Delay:**

This item specifies the read to write delay.

*** DRAM Command Rate:**

When the host (northbridge) locates the desired memory address, it then processes the wait state of commands.

*** Read Preamble value:**

This item specifies the read preamble value.

*** Max. Async Latency value:**

This item specifies the Max Async value.

*** Bank Interleaving:**

Depending on your SDRAM module structure, the 4-Way setting can offer the best performance. If you choose the wrong setting, the computer system will not run in a stable manner. For detailed information on your SDRAM module, please ask your SDRAM module manufacturer.

*** Burst Length**

DDR SDRAM modules provide a Burst mode that means an auto precharge function for programmable READ or WRITE burst lengths of 2, 4 or 8 locations.

This means that if we set burst length to 8, the address bus will access 8 bytes each cycle to precharge, etc.

*** DRAM Drive Strength:**

This item specifies the mode of DRAM Drive Strength.

*** Force 64-bit mode always:**

This item enables or disables the force 64-bit mode always function.

*** R/W Queue Bypass Counter:**

This item specifies the R/W Queue Bypass Counter value.

*** Bypass Max:**

This item specifies the Bypass Max value.

*** Idle Cycle Limit(ILD-Lmt):**

This item specifies the idle cycle limit.

*** Dynamic Idle Cycle Count:**

This item specifies the dynamic idle cycle count value.

MTRR mapping mode

The item selects the MTRR mapping mode. The MTRR (Memory-Type and Range Registers) controls the access and cacheability of memory regions in the processor.

32 bit Dram Memory Hole:

This item selects the method to remap the 32 bit Dram memory hole. Leave this item to its default “**Auto**” Setting.

↶ Back to Advanced Chipset Features Setup Menu:

SSE/SSE2 Instructions:

This item allows you to Enable or Disable the SSE/SSE2 (Streaming SIMD Extensions) instruction set. The default setting is Enabled.

System BIOS Cacheable:

Two options are available: Disabled or Enabled. When you select *Enabled*, you get faster system BIOS executing speed via the L2 cache.

3-5. Integrated Peripherals

Phoenix - Award WorkstationBIOS CMOS Setup Utility		
Integrated Peripherals		
▶ IDE/RAID Function	Press Enter	Item Help
Init Display First	PCI Slot	
OnChip USB	V1.1+V2.0	
- USB Keyboard Support via	OS	
- USB Mouse Support via	OS	
OnChip Audio Controller	Auto	
OnChip LAN Controller	Auto	
- Onboard LAN Boot ROM	Disabled	
Onboard 1394 Controller	Enabled	
Onboard FDD Controller	Enabled	
↑↓:Move Enter:Select +/-/PU/PD:Value F10:Save ESC:Exit F1:General Help F5: Previous Values F6: Fail-Safe Defaults F7: Optimized Defaults		

☞ IDE/RAID Function

Click <Enter> key to enter its submenu:

Phoenix - Award WorkstationBIOS CMOS Setup Utility		
IDE/RAID Fuction Setup		
▶ IDE Function Setup	Press Enter	Item Help
▶ RAID Config	Press Enter	
↑↓:Move Enter:Select +/-/PU/PD:Value F10:Save ESC:Exit F1:General Help F5: Previous Values F6: Fail-Safe Defaults F7: Optimized Defaults		

☚ IDE Function Setup:

Click <Enter> key to enter its submenu:

Phoenix - Award WorkstationBIOS CMOS Setup Utility		
IDE Fuction Setup		
		Item Help
OnChip IDE Channel 1	Enabled	
OnChip IDE Channel 2	Enabled	
IDE DMA transfer access	Enabled	
IDE HDD Block Mode	Enabled	
Serial-ATA 1/2	Enabled	
Serial-ATA 3/4	Enabled	
↑ ↓ :Move Enter:Select +/-/PU/PD:Value F10:Save ESC:Exit F1:General Help F5: Previous Values F6: Fail-Safe Defaults F7: Optimized Defaults		

OnChip IDE Channel 1/ OnChip IDE Channel 2:

This item allows you to enable or disable the primary (IDE1) and secondary (IDE2) IDE controller. Select [Disabled] if you want to add a different hard drive controller.

IDE DMA transfer access:

This item selects the DMA mode for devices connected through IDE channels.

IDE HDD Block Mode:

This item enables or disables the IDE HDD Block Mode.

Serial-ATA 1/2, Serial ATA 3/4:

This item enables or disables the on-chip SATA controller.

🔗 RAID Config:

Click <Enter> key to enter its submenu:

Phoenix - Award WorkstationBIOS CMOS Setup Utility		
RAID Config		Item Help
RAID Enable	Diabled	
X - IDE 1 Master RAID	Disabled	
X - IDE 1 Slave RAID	Disabled	
X - IDE 2 Master RAID	Disabled	
X - IDE 2 Slave RAID	Disabled	
X - Serial-ATA 1 RAID	Disabled	
X - Serial-ATA 2 RAID	Disabled	
X - Serial-ATA 3 RAID	Disabled	
X - Serial-ATA 4 RAID	Disabled	

↑ ↓ : Move Enter : Select +/- /PU/PD : Value F10 : Save ESC : Exit F1 : General Help
F5 : Previous Values F6 : Fail-Safe Defaults F7 : Optimized Defaults

RAID Enable:

This item allows you to enable or disable the IDE RAID function.

* IDE 1/2 Master/Slave RAID, Serial ATA 1/2/3/4 RAID:

Select the disks that you want to use as RAID disks.

🔗 Back to Integrated Peripherals Setup Menu:

Init Display First:

This item selects which display slot to be initialized first when the system boots.

[PCI Slot]: When the system boots, it will first initialize PCI.

[PCIEx]: When the system boots, it will first initialize PCIE.

OnChip USB:

Three options are available: Disabled ➔ V1.1+V2.0 ➔ V1.1. The default setting is *V1.1+V2.0*. If you choose to disable this item, the “USB Keyboard Support” and “USB Mouse Support” items will not be able to select in *Integrated Peripherals* menu.

* USB Keyboard Support via:

This item allows you to select [BIOS] for using USB keyboard in DOS environment, or [OS] in OS environment.

* USB Mouse Support via:

This item allows you to select [BIOS] for using USB mouse in DOS environment, or [OS] in OS environment.

OnChip Audio Controller:

This option enables or disables the audio controller.

OnChip LAN Controller:

This option enables or disables the LAN controller.

*** Onboard LAN Boot ROM:**

This item allows you to use the boot ROM (instead of a disk drive) to boot-up the system and access the local area network directly.

Onboard IEEE1394 Controller:

This option enables or disables the IEEE 1394 controller.

Onboard FDD Controller:

Two options are available: Enabled and Disabled. The default setting is *Enabled*. You can enable or disable the onboard FDC controller.

3-6. Power Management Setup

Phoenix - Award WorkstationBIOS CMOS Setup Utility		
Power Management Setup		
ACPI Suspend Type	S3 (Suspend-to-RAM)	Item Help
- USB Resume from S3	Disabled	
Power Button Function	Instant-Off	
Wake-Up by PME# of PCI	Disabled	
Wake-Up by OnChip LAN	Enabled	
Wake-Up by Alarm	Disabled	
X - Date (of Month) Alarm	0	
X - Time (hh:mm:ss) Alarm	0 : 0 : 0	
AMD K8 Cool'n'Quiet Control	Enabled	
POWER ON Function	BUTTON ONLY	
X - KB Power ON Password	Enter	
X - Hot Key Power ON	Ctrl-F1	
Restore on AC Power Loss	Power Off	
↑ ↓ : Move Enter : Select +/- /PU/PD : Value F10 : Save ESC : Exit F1 : General Help F5 : Previous Values F6 : Fail-Safe Defaults F7 : Optimized Defaults		

ACPI Suspend Type:

This item selects the type of Suspend mode.

[S1(PowerOn-Suspend)]: Enables the Power On Suspend function.

[S3(Suspend-To-RAM)]: Enables the Suspend to RAM function.

*** USB Resume from S3:**

Two options are available: Disabled or Enabled. The default setting is *Disabled*. When set to *Enabled*, any event related to onchip USB will power on the system. This item can be configured only if the item "ACPI Suspend Type" is set to [S3(STR)].

Power Button Function:

Two options are available: Delay 4 Sec or Instant-Off. The default setting is *Instant-Off*. It is activated when the user presses the power button for more than four seconds while the system is in the working state, then the system will transition to the soft-off (Power off by software). This is called the power button over-ride.

Wakeup by PME# of PCI:

Two options are available: Disabled or Enabled. The default setting is *Enabled*. When set to *Enabled*, any event related to PCI cards (PME) will power on the system.

Wake-Up by OnChip LAN:

When set to [Enabled], you can remotely wake up a PC in Soft-Off condition via a LAN card that support the wake up function.

Wake-Up by Alarm:

Two options are available: Disabled or Enabled. The default setting is *Disabled*. When set to *Enabled*, you can set the date and time at which the RTC (real-time clock) alarm awakens the system from Suspend mode.

*** Date (of Month) Alarm/ Time (hh:mm:ss) Alarm:**

You can set the Date (month) Alarm and Time Alarm (hh:mm:ss). Any event occurring will awaken a system that has powered down.

AMD Cool 'n' Quiet Control:

This option enables or disables the AMD K8 cool and quiet function.

NOTE: Please disable this item while running under SLI mode.

Power On Function:

This item selects the way you want your system to power on.

[Password]: Use a password to power on the system, select this option then press <Enter>. Enter your password. You can enter up to 5 characters. Type in exactly the same password to confirm, and then press <Enter>.

[Hot KEY]: Use any of the function keys between <F1> to <F12> to power on the system.

[Mouse Left]: Double click the mouse left button to power on the system.

[Mouse Right]: Double click the mouse right button to power on the system.

[Any KEY]: Use any keyboard key to power on the system.

[BUTTON ONLY]: Use only the power button to power on the system.

[Keyboard 98]: Use the power-on button on the "Keyboard 98" compatible keyboard to power on the system.

*** KB Power On Password:**

This item sets the password required in order to power on your computer. Once the password has been set, you can only power on the system by inputting the password.

*** Hot Key Power On:**

Fifteen options are available: Ctrl+F1 ~ Ctrl+F12, Power, Wake and Any Key. The default setting is *Ctrl+F1*. You can choose the hot key you want to turn on computer power.

Restore on AC Power Loss:

This item selects the system action after an AC power failure.

[Power Off]: When power returns after an AC power failure, the system's power remains off. You must press the Power button to power-on the system.

[Power On]: When power returns after an AC power failure, the system's power will be powered on automatically.

[Last State]: When power returns after an AC power failure, the system will return to the state where you left off before power failure occurs. If the system's power is off when AC power failure occurs, it will remain off when power returns. If the system's power is on when AC power failure occurs, the system will power-on when power returns.

3-7. PnP/PCI Configurations

Phoenix - Award WorkstationBIOS CMOS Setup Utility PnP/PCI Configurations		
Resources Controlled By	Auto (ESCD)	Item Help
x IRQ Resources	Press Enter	
PCI/VGA Pallette Snoop	Disbaled	
PIRQ_0 Use IRQ No.	Auto	
PIRQ_1 Use IRQ No.	Auto	
PIRQ_2 Use IRQ No.	Auto	
PIRQ_3 Use IRQ No.	Auto	
** PCI Express relative items **		
Maximum Payload Size	4096	
↑ ↓ : Move Enter : Select +/- / PU / PD : Value F10 : Save ESC : Exit F1 : General Help F5 : Previous Values F6 : Fail-Safe Defaults F7 : Optimized Defaults		

Resources Controlled By:

This item configures all of the boot and Plug-and-Play compatible devices.

[Auto(ESCD)]: The system will automatically detect the settings.

[Manual]: Choose the specific IRQ resources in the “IRQ Resources” menu.

↳ IRQ Resources:

Click <Enter> key to enter its submenu:

This item sets each system interrupt to either [PCI Device] or [Reserved].

Phoenix - Award WorkstationBIOS CMOS Setup Utility	
PnP/PCI Configurations	
IRQ-3 assigned to	PCI Device
IRQ-4 assigned to	PCI Device
IRQ-5 assigned to	PCI Device
IRQ-7 assigned to	PCI Device
IRQ-10 assigned to	PCI Device
IRQ-11 assigned to	PCI Device

↑ ↓ : Move Enter : Select +/- /PU/PD : Value F10 : Save ESC : Exit F1 : General Help
F5 : Previous Values F6 : Fail-Safe Defaults F7 : Optimized Defaults

↳ Back to PnP/PCI Configurations Setup Menu:

PCI/VGA Palette Snoop:

This item determines whether the MPEG ISA/VESA VGA cards can work with PCI/VGA or not.

[Disabled]: MPEG ISA/VESA VGA cards do not work with PCI/VGA.

[Enabled]: MPEG ISA/VESA VGA cards work with PCI/VGA.

PIRQ_0 Use IRQ No. ~ PIRQ 3 Use IRQ No.:

This item specifies the IRQ number manually or automatically for the devices installed on PCI slots.

Maximum Payload Size:

This item sets the maximum TLP payload size for the PCI Express devices.

3-8. PC Health Status

You can set the warning temperature for your computer system, and you can check the fan speeds and power supply voltages of your computer system. The features are useful for monitoring all the important parameters within your computer system. We call it the *PC Health Status*.

Phoenix - AwardBIOS CMOS Setup Utility		
PC Health Status		
		Item Help
FAN Fail Alarm Selectable	Disabled	
Shutdown when FAN Fail	Disabled	
CPU FanEQ Speed Control	Disabled	
- CPU FAN Active Temperature	70	
Shutdown Temperature	Disabled	
CPU Warning Temperature	Disabled	
CPU Temperature	48°C/118°F	
System Temperature	42°C/107°F	
PWM Temperature	42°C/107°F	
CPU FAN Speed	3125 RPM	
SYS FAN Speed	4963 RPM	
AUX1 FAN Speed	0 RPM	
CPU Core Voltage	1.52 V	
DDR Voltage	2.67 V	
ATX +3.3V	3.31 V	
ATX +5V	5.08 V	
ATX +12V	11.97 V	
CK804 CORE Voltage	1.56 V	
Hyper Transport Voltage	1.23 V	
+3V Dual	2.27 V	
↑ ↓ :Move Enter:Select +/-/PU/PD:Value F10:Save ESC:Exit F1:General Help F5: Previous Values F6: Fail-Safe Defaults F7: Optimized Defaults		

FAN Fail Alarm Selectable:

This item selects the fan that will be monitored for malfunction.

Shutdown When Fan Fail:

The system will be shut down if the selected fan is not running.

CPU FanEQ Speed Control:

This item allows you to control the CPU fan speed down to a specific percentage.

When set to a specific percentage, the CPU fan speed will run at the percentage you set in this item if the temperature limit set in the item “Active Temperature” is not exceeded.

The CPU fan speed will run at 100% regardless of what the percentage you set in this item if the temperature limit set in the item “Active Temperature” is exceeded.

* CPU FAN Active Temperature:

This item sets the temperature limit that would activate the function of “CPU FanEQ Speed Control” option.

Shutdown Temperature:

You can set the processor shutdown temperature here. If the processor temperature exceeds the settings value, system will force to shutdown to protect the processor not overheat.

CPU Warning Temperature:

This item lets you select the temperature at which you want the system to send out a warning message to the PC speakers of when the temperature goes beyond either limit. You can select the temperatures you want.

All Voltages, Fans Speed and Thermal Monitoring:

These unchangeable items list the current status of the CPU and environment temperatures, fan speeds, and system power voltage.

NOTE: The hardware monitoring features for temperatures, fans and voltages will occupy the I/O address from 294H to 297H. If you have a network adapter, sound card or other add-on cards that might use those I/O addresses, please adjust your add-on card I/O address to avoid using these addresses.

3-9. Load Fail-Safe Defaults

This option loads the BIOS default values for the most stable, minimal-performance system operations.

3-10. Load Optimized Defaults

This option loads the BIOS default values that are factory settings for optimal-performance system operations.

3-11. Set Password

This option protects the BIOS configuration or restricts access to the computer itself.

3-12. Save & Exit Setup

This option saves your selections and exits the BIOS setup menu.

3-13. Exit Without Saving

This option exits the BIOS setup menu without saving any change.

Appendix A. Install nVidia nForce Chipset Driver

NOTE: Please install this NVIDIA nForce Chipset driver first after having installed the Windows operating system.

The installation procedures and screen shots in this section are based on the Windows XP operating system. For other operating systems, please follow the on-screen instructions.

Insert the Driver & Utility CD into the CD-ROM drive. It should execute the installation program automatically. If not, double-click the executable file at the main directory of this CD to enter the installation menu.

After entering the installation menu, move your cursor to [Drivers] tab. Click [nVidia nForce Chipset Driver]. The following screen appears.

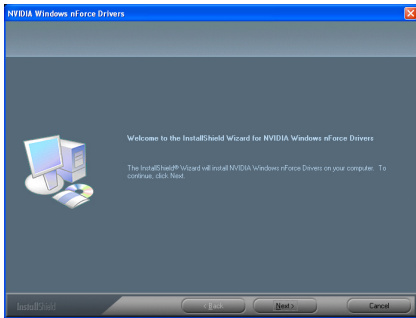

1. Click [Next].

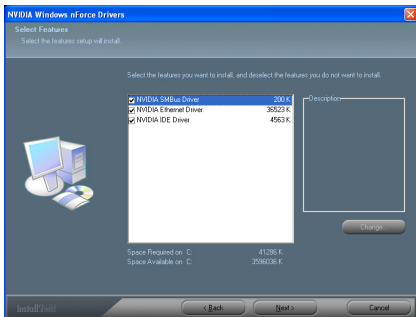

2. Click [Next].

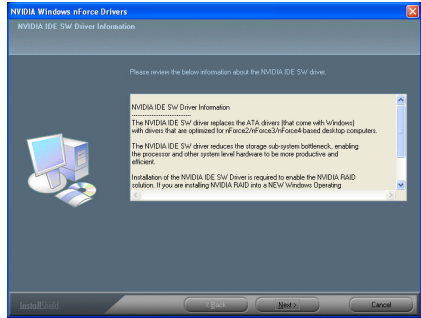

3. Click [Next].

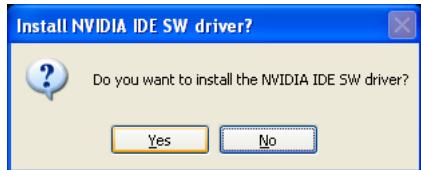

4. Click [Yes].

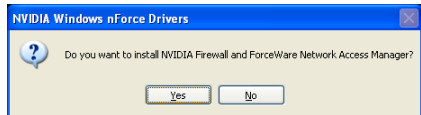

5. Click [Yes].

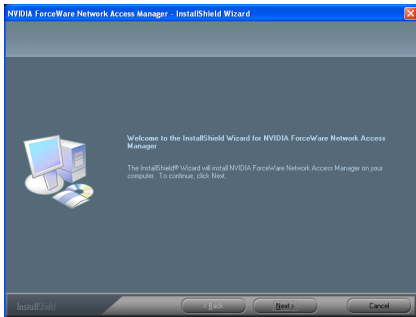

6. Click [Next].

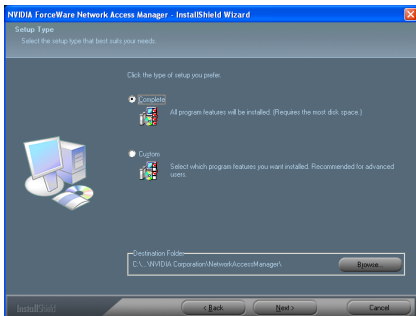

7. Click [Next].

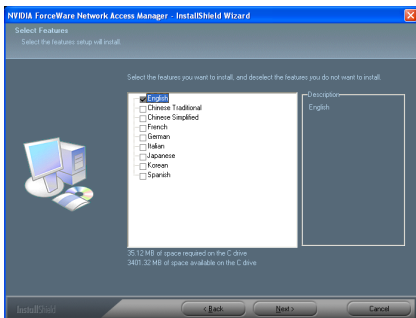

8. Click [Next].

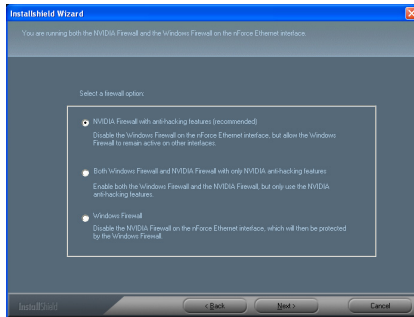

9. Click [Next].

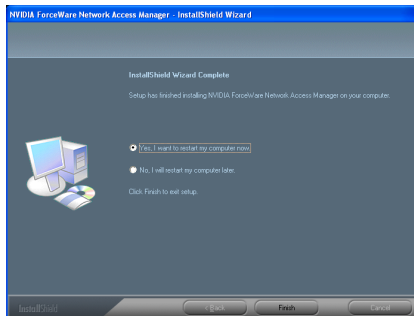

10. Choose [Yes, I want to restart my computer now.], and click [Finish] to complete setup.

Appendix B. Install Realtek Audio Driver

The installation procedures and screen shots in this section are based on Windows XP operating system. For those of other OS, please follow its on-screen instruction.

Insert the Driver & Utility CD into CD-ROM drive, it should execute the installation program automatically. If not, double-click the execution file at the main directory of this CD to enter the installation menu.

After entering the installation menu, move your cursor to [Drivers] tab. Click [Realtek Audio Driver]. The following screen appears.

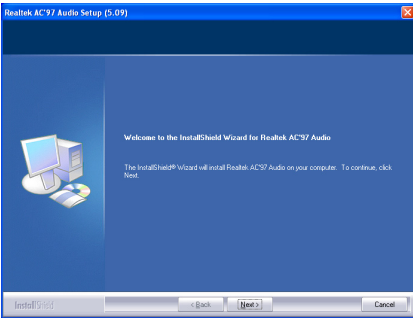

1. Click [Next].

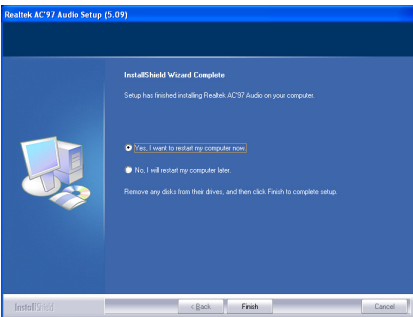

2. Choose [Yes, I want to restart my computer now.], and click [Finish] to complete setup.

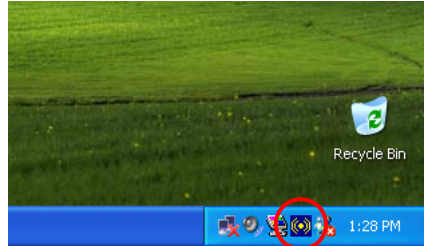

3. After the system restarted, a shortcut icon appears at the right corner of Windows task bar.



4. Double click the icon and the [AUDIO EQ] control panel will appear.

NOTE: Click the [SPDIF] tab on the top of the control panel, and the page allows you to configure the settings for the Digital Audio input and output. There are four S/PDIF-Out options provided.

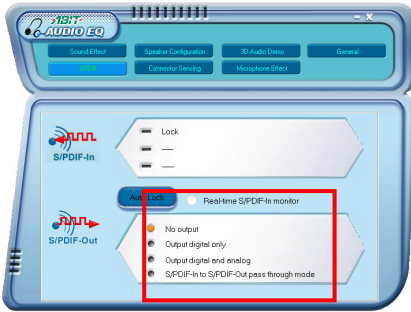

- **[No Output]**

S/PDIF-Out function is disabled and there will be no output signals.

- **[Output digital only]**

The output signal will be transmitted from the real-time digital audio signal in play mode only (ex: mp3, wav).

- **[Output digital and analog]**

The signal will be transmitted via both the digital audio signal (ex: mp3, wav) and the analog signal (ex: CD-in) simultaneously.

Enable [Real-time S/PDIF-In Monitor] option under this mode will transmit the signals from S/PDIF-In in real-time with other signals.

- **[S/PDIF-In to S/PDIF-Out pass through mode]**

The pass through mode completely allows the incoming signal from S/PDIF-In port to transmit directly to S/PDIF-Out port.

Appendix C. Install Cool'n'Quiet Driver

The installation procedures and screen shots in this section are based on Windows XP operating system. For those of other OS, please follow its on-screen instruction.

Insert the Driver & Utility CD into CD-ROM drive, it should execute the installation program automatically. If not, double-click the execution file at the main directory of this CD to enter the installation menu.

After entering the installation menu, move your cursor to [Drivers] tab. Click [Cool'n'Quiet Driver]. The following screen appears.

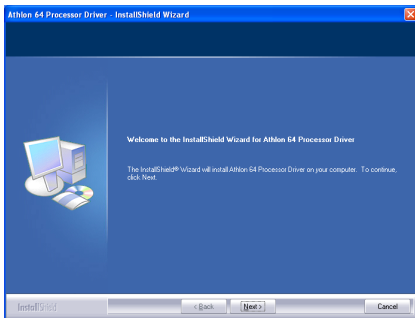

1. Click [Next].

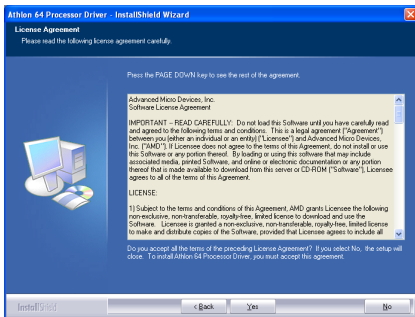

2. Click [Yes].

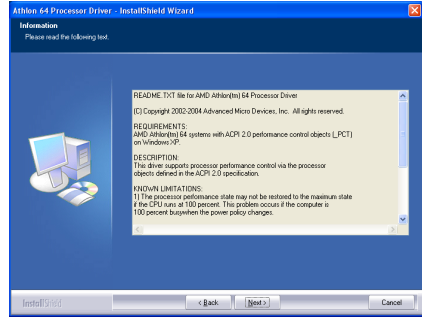

3. Click [Next].

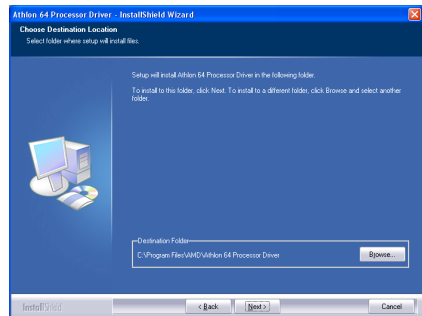

4. Click [Next].

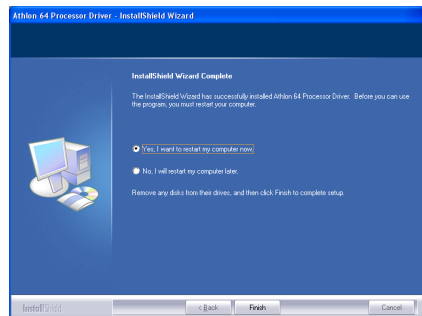

5. Choose [Yes, I want to restart my computer now.], and click [Finish] to complete setup.

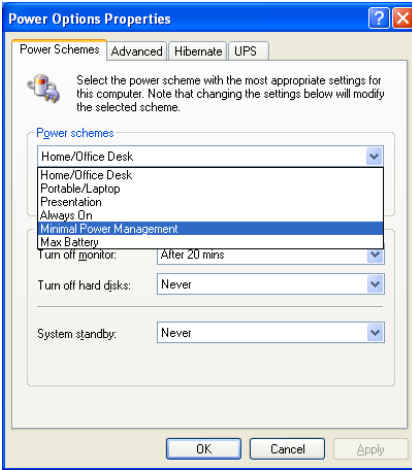

- After the system restarted, open the “Power Options” from the control panel and choose the power scheme “Minimal Power Management” to enable Cool ‘n’ Quiet.

NOTE: For Windows 2000 or ME system, an AMD Cool ‘n’ Quiet tab will appear under “Power Options” when the Cool ‘n’ Quiet software for Windows 2000 and ME is installed. This must be set to “Automatic Mode” for Cool ‘n’ Quiet to be enabled.

Appendix D. Install USB 2.0 Driver

NOTE: The installation for USB 2.0 driver for Windows XP or Windows 2000 is currently available by updating the latest Service Pack from Microsoft's web site.



Appendix E. ABIT EQ (The Hardware Doctor Utility)

ABIT EQ is a self-diagnostic system for PC based on motherboards designed and manufactured by ABIT Computer Corporation. It will protect PC Hardware by monitoring critical items of Power Supply Voltage, CPU & System Fans Speed, and CPU & System Temperature.

The installation procedures and screen shots in this section are based on the Windows XP operating system. For other operating systems, please follow the on-screen instructions.

Insert the Driver & Utility CD into the CD-ROM drive. It should execute the installation program automatically. If not, double-click the executable file at the main directory of this CD to enter the installation menu.

After entering the installation menu, move your cursor to [ABIT Utility] tab. Click [ABIT EQ]. The following screen appears.

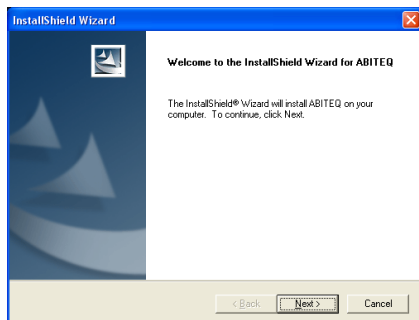

1. Click [Next].

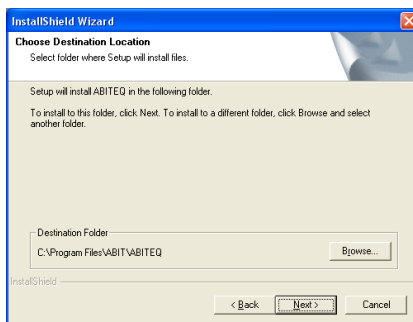

2. Click [Next].

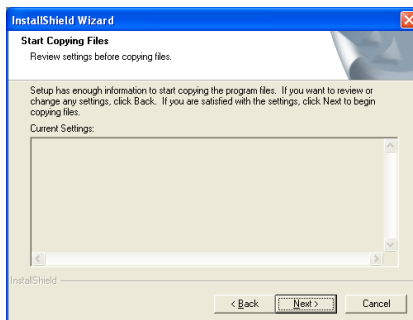

3. Click [Next].

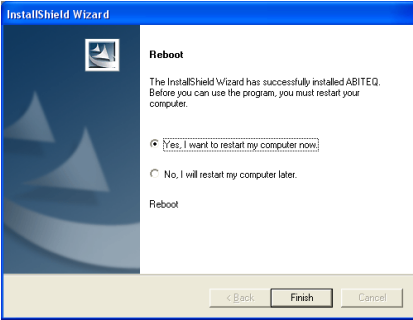

- 4. Choose [Yes, I want to restart my computer now.] and click [Finish] to complete setup.

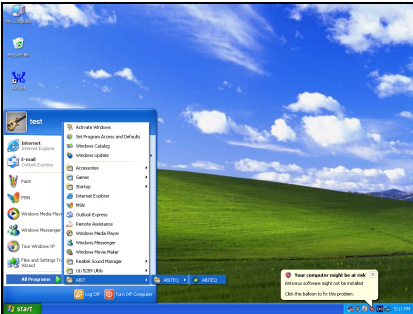

- 5. Execute the ABIT EQ by entering the Windows Menu [Start] → [All Programs] → [ABIT] → [ABIT EQ].



- 6. This screen appears. ABIT EQ shows you the status of Voltage, Fan Speed, and Temperature readings as well.

Appendix F. FlashMenu (BIOS Update Utility)

ABIT FlashMenu is the most stable Windows-based BIOS flash available. No more worries from crashing. With one click of BIOS updating, ABIT users can flash their BIOS more easily and in less time.

The installation procedures and screen shots in this section are based on the Windows XP operating system. For other operating systems, please follow the on-screen instructions.

Insert the Driver & Utility CD into the CD-ROM drive. It should execute the installation program automatically. If not, double-click the executable file at the main directory of this CD to enter the installation menu.

After entering the installation menu, move your cursor to [ABIT Utility] tab. Click [FlashMenu]. The following screen appears.

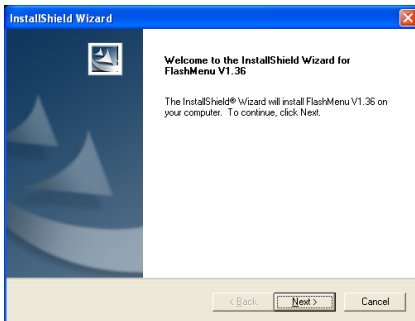

1. Click [Next].

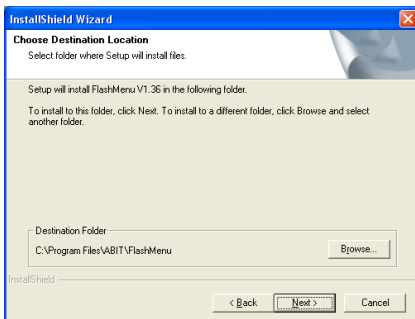

2. Click [Next].

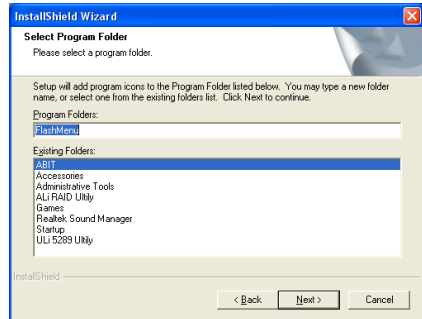

3. Click [Next].

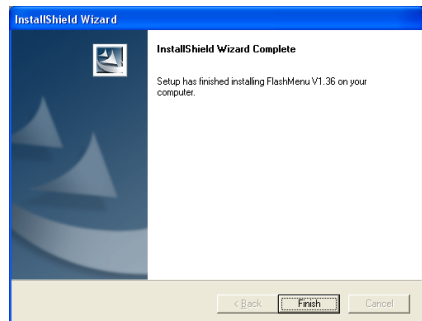

4. Click [Finish] to complete setup.

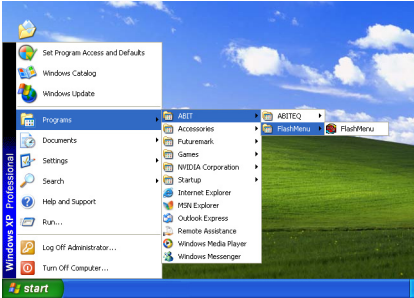

5. Execute the FlashMenu by entering the Windows Menu [Start] → [All Programs] → [ABIT] → [FlashMenu].



6. This FlashMenu screen appears. You can easily update the BIOS from clicking [Update From File], [One Click LiveUpdate], or [LiveUpdate Step by Step] button.

Appendix G. NVRaid Floppy Disk

If you lost or damaged the SATA Driver Disk that came with the package, use the NVRaid Floppy Disk to create another one.

The installation procedures and screen shots in this section are based on Windows XP operating system. For those of other OS, please follow its on-screen instruction.

Insert the Driver & Utility CD into CD-ROM drive, it should execute the installation program automatically. If not, double-click the execution file at the main directory of this CD to enter the installation menu.

After entering the installation menu, move your cursor to [ABIT Utility] tab. Click [AN8 NVRaid Floppy Disk]. The following screen appears.

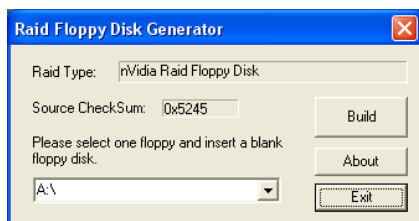

1. Insert one blank floppy disk to the selected floppy drive and click [Build].

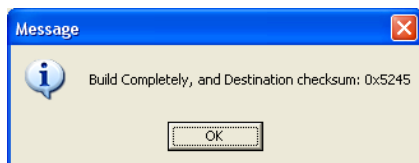

2. Click [OK] to finish building the SATA Driver Disk.

NOTE: If you are using a windows 2000 operating system, please update your system to Service Pack 4 before starting to setup the NVIDIA RAID.



Appendix H. Troubleshooting (Need Assistance?)

Q & A:

Q: Do I need to clear the CMOS before I use a new motherboard to assemble my new computer system?

A: Yes, we highly recommend that you clear the CMOS before installing a new motherboard. Please move the CMOS jumper from its default 1-2 position to 2-3 for a few seconds, and then back. When you boot up your system for the first time, follow the instructions in the user's manual to load the optimized defaults.

Q: If my system hangs when I update the BIOS or set the wrong CPU parameters, what should I do?

A: Whenever you update the BIOS or if the system hangs due to wrong CPU parameters setting, always clear CMOS jumper before booting up again.

Q: Why does the system fail to boot up again right after a mechanical power-off?

A: Please keep a 30-second interval between each mechanical power On/Off.

Q: Why does the system fail to boot up and nothing displays on the screen after I did some overclocking or non-standard settings inside the BIOS? Is the motherboard dead? Do I need to return it to where I bought from or go through an RMA process?

A: It should not cause hardware or permanent damage to motherboard when BIOS settings were changed from default to over-clocking or non-standard status.

We suggest the following three troubleshooting methods to discharge CMOS data, recover the hardware default status, and then making the motherboard work again. There is no need to bother returning the motherboard to where you bought it from or go through an RMA process.

Step 1. Switch off the power supply unit and then switch it on again after one minute. If there is no power switch on the power supply unit, disconnect its power cord for one minute and then reconnect.

Press and hold the <Insert> key on the keyboard, and press the power-on button to boot up system. If it works, release the <Insert> key and hit key to enter the BIOS setup page to apply the correct settings.

If the situation remains the same, repeat the procedures in Step 1 for three times, or try Step 2.

Step 2. Switch off the power supply unit or disconnect the power cord. Open the chassis cover. Locate the CCMOS jumper near the button battery. Change the jumper position from default 1-2 to 2-3 for one minute to discharge the CMOS data, and then put it back to default 1-2 position.

Close the chassis and switch on the power supply unit or plug in the power cord. Press the power-on button to boot up system. If it works, hit key to enter the BIOS setup page to do the correct settings.

If the situation remains the same, try Step 3.

Step 3. The same procedure as Step 2, but while discharging the CMOS data, pull out the ATX power connectors from motherboard and remove the button battery during CMOS discharge.

Q: How can I get a quick response to my request for technical support?

A: Be sure to follow the guidelines as stated in the “Technical Support Form” section of this manual.

If you have a problem during operation, in order to help our technical support personnel quickly determine the problem with your motherboard and give you the answers you need, eliminate any peripheral that is not related to the problem, and indicate it on the form. Fax this form to your dealer or to the company where you bought the hardware in order to receive prompt technical support. (You can refer to the examples given below)

Example 1:

With a system including: motherboard (with CPU, DRAM...) HDD, CD-ROM, FDD, VGA CARD, MPEG CARD, SCSI CARD, SOUND CARD, etc. If you cannot boot up after the system is assembled, check the key components of the system using the procedure described below. First remove all interface cards except the VGA card and try to reboot.

If you still cannot boot up: Try installing another brand/model VGA card and see if the system will start. If it still does not start, note the VGA card model, motherboard model, Bios identification number, and CPU on the technical support form (refer to main instructions), and describe the problem in the space provided.

If you can boot up: Insert the interface cards you have removed back into the system one by one, and try to start the system each time you insert a card until the system will not start. Keep the VGA card and the interface card that caused the problem inserted on the motherboard, remove any other cards or peripheral, and start again. If you still cannot start, note the information related to both cards in the add-on Card space provided, and don't forget to indicate the motherboard model, version, BIOS identification number, CPU (refer to main instructions), and give a description of the problem.

Example 2:

With a system including the motherboard (with CPU, DRAM...) HDD, CD-ROM, FDD, VGA CARD, LAN CARD, MPEG CARD, SCSI CARD, SOUND CARD, after assembly and after having installed the sound card driver, when you restart the system, it resets automatically when it runs the sound card Driver,. This problem may be due to the sound card driver. During the Starting DOS... procedure, press SHIFT (BY-PASS) key, to skip CONFIG.SYS and AUTOEXEC.BAT; edit CONFIG.SYS with a text editor, and in line that loads the sound card driver, add a remark REM, in order to disable the sound card driver. See the example below.

```
CONFIG.SYS:
DEVICE=C:\DOS\HIMEM.SYS
DEVICE=C:\DOS\EMM386.EXE HIGHSCAN
DOS=HIGH, UMB
FILES=40
BUFFERS=36
REM DEVICEHIGH=C:\PLUGPLAY\DWCFGMG.SYS
LASTDRIVE=Z
```

Restart the system. If the system starts and does not reset, you can be sure that the problem is due to the sound card driver. Write down the sound card model, motherboard model, BIOS identification number on the technical support file (refer to main instructions), and describe the problem in the space provided.

We will show you how to fill the “Technical Support Form”.

Main instructions:

To fill in this “**Technical Support Form**”, refer to the step-by-step instructions given below:

- 1* **MODEL:** Note the model number given in your user’s manual.
Example: KN8 SLI
- 2* **Motherboard model number (REV):** Note the motherboard model number labeled on the motherboard as “REV:*.**”.
Example: REV: 1.00
- 3* **BIOS ID and Part Number:** See the on screen message.
4. **DRIVER REV:** Note the driver version number indicated on the DEVICE DRIVER disk (if any) as “Release *.**”. For example:

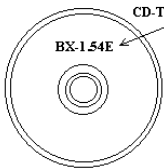

- 5* **OS/APPLICATION:** Indicate the operating system and applications you are running on the system.
Example: MS-DOS® 6.22, Windows® 98 SE, Windows® 2000, etc....
- 6* **CPU:** Indicate the brand and the speed (MHz) of your CPU.
Example:(A) In the “Brand” space, write “Intel”; in the “Specifications” space, write “Pentium® 4 1.9GHz”.
7. **HDD:** Indicate the brand and specifications of your HDD(s); specify if the HDD is using IDE1 or IDE2. If you know the disk capacity, indicate it and check (“✓”) “”; in case you give no indication, we will consider that your HDD is “IDE1” Master.
Example: In the “HDD” space, check the box; in the Brand space, write “Seagate”; in the Specifications space, write “ST31621A (1.6GB)”.
8. **CD-ROM Drive:** Indicate the brand and specifications of your CD-ROM drive. Specify if it uses IDE1 or IDE2 , and check (“✓”) “”; in case you give no indication, we will consider that your CD-ROM is “IDE2” Master.
Example: In the “CD-ROM drive” space, check the box, in the Brand space, write “Mitsumi”, in the Specifications space, write “FX-400D”.
9. **System Memory (DDR SDRAM):** Indicate the brand and specifications (DDR DIMM) of your system memory. Such as Density, Description, Module Components, Module Part Number, CAS Latency, and Speed (MHz).
For example: In the Brand space, write “**Micron**”; in the Specifications space, write: **Density:** 128MB, **Description:** SS 16 Megx72 2.5V ECC Gold, **Module Components:** (9) 16 Megx 8, **Module Part Number:** MT9VDDT1672AG, **CAS Latency:** 2, **Speed (MHz):** 200 MHz.
Please give us the detailed information of your DDR SDRAM module; it will help us to simulate the problems you met.
10. **ADD-ON CARD:** Indicate which add-on cards you are *absolutely sure* are related to the problem. If you cannot identify the problem’s origin, indicate all the add-on cards inserted into your system.

NOTE: Items between the “*” are absolutely necessary.

 **Technical Support Form**

 **Company Name:**

 **Phone Number:**

 **Contact Person:**

 **Fax Number:**

 **E-mail Address:**

Model	*	BIOS ID #	*
Motherboard Model No.		DRIVER REV	
OS/Application	*		
Hardware Name	Brand	Specifications	
CPU	*		
HDD			
<input type="checkbox"/> IDE1 <input type="checkbox"/> IDE2			
CD-ROM-Drive			
<input type="checkbox"/> IDE1 <input type="checkbox"/> IDE2			
System Memory			
ADD-ON CARD			

Problem Description:



Appendix I. How to Get Technical Support

(From our website) <http://www.abit.com.tw>

(In North America) <http://www.abit-usa.com>

(In Europe) <http://www.abit.nl>

Thank you for choosing ABIT products. ABIT sells all our products through distributors, resellers and system integrators; we have no direct sales to end-users. Before sending email for tech support please check with your resellers or integrators if you need any services, they are the ones who sold you your system and they should know best as to what can be done, how they serve you is a good reference for future purchases.

We appreciate every customer and would like to provide the best service to you. Providing fast service to our customers is our top priority. However we receive many phone calls and a huge amount of email from all over the world. At the present time it is impossible for us to respond to every single inquiry.

We have done many compatibility tests and reliability tests to make sure our products have the best quality and compatibility. In case you need service or technical support, please understand the constraints that we have and **always check with the reseller who sold the product to you first.**

To expedite service, we recommend that you follow the procedures outlined below before contacting us. With your help, we can meet our commitment to provide the best service to the greatest number of ABIT customers:

- 1. Check the Manual.** It sounds simple but we have taken a lot of care in making a well-written and thorough manual. It is full of information that doesn't only pertain to motherboards. The CD-ROM included with your board will have the manual as well as drivers. If you don't have either one, go to our Program Download area of the website or our FTP server.
- 2. Download latest BIOS, software or drivers.** Please go to our Program Download area on our website to check to see if you have the latest BIOS. They are developed over periods of time to fix bugs or incompatibilities. **Also please make sure you have the latest drivers from your peripheral card makers!**
- 3. Check the ABIT Technical Terms Guide and FAQ on our website.** We are trying to expand and make the FAQs more helpful and information rich. Let us know if you have any suggestions. For hot topics, check out our HOT FAQ!

4. **Internet Newsgroups.** These are a great source of information and many people there can offer help. ABIT's Internet News group, alt.comp.peripherals.mainboard.abit, is an ideal forum for the public to exchange information and discuss experiences they have had with ABIT products. Many times you will see that your question has already been asked before. This is a public Internet news group and it is reserved for free discussions. Here is a list of some of the more popular ones:

alt.comp.peripherals.mainboard.abit
comp.sys.ibm.pc.hardware.chips
alt.comp.hardware.overclocking
alt.comp.hardware.homebuilt
alt.comp.hardware.pc-homebuilt

5. **Ask your reseller.** Your ABIT authorized distributor should be able to provide the fastest solution to your technical problem. We sell our products through distributors who sell to resellers and stores. Your reseller should be very familiar with your system configuration and should be able to solve your problem much more efficiently than we could. After all, your reseller regards you as an important customer who may purchase more products and who can urge your friends to buy from him or her as well. They integrated and sold the system to you. They should know best what your system configuration is and your problem. They should have reasonable return or refund policies. How they serve you is also a good reference for your next purchase.
6. **Contacting ABIT.** If you feel that you need to contact ABIT directly you can send email to the ABIT technical support department. First, please contact the support team for the branch office closest to you. They will be more familiar with local conditions and will have better insight as to which resellers offer what products and services. Due to the huge number of emails coming in every day and other reasons, such as the time required for problem reproduction, we will not be able to reply to every email. Please understand that we are selling through distribution channels and while we don't have the resources to serve every end-user, we will do our best to help every customer. Please also remember that for many of our technical support team English is a second language. You will have a better chance of getting a helpful answer if your question can be quickly understood. Be sure to use very, simple, concise language that clearly states the problem, avoid rambling or flowery language, and always list your system components and operating system. Here is the contact information for our branch offices:

North America and South America **ABIT Computer (U.S.A.) Corporation**
2901 Bayview Drive
Fremont, CA 94538
U.S.A.
Tel: 1-510-623-0500
Fax: 1-510-623-1092
Sales: sales@abit-usa.com
Latin America Sales: ventas@abit-usa.com
Marketing: marketing@abit-usa.com
Web Site: <http://www.abit-usa.com>

RMA Center: <http://rma.abit-usa.com/>

UK and Ireland **ABIT Computer (U.K.) Corporation Ltd.**
Unit 3, 24-26 Boulton Road, Stevenage,
Herts SG1 4QX, UK
Tel: 44-1438-228888
Fax: 44-1438-226333
E-mail: sales@abitcomputer.co.uk

Germany and Benelux (Belgium, Netherlands, Luxembourg), France, Italy, Spain, Portugal, Greece, Denmark, Norway, Sweden, Finland, and Switzerland **AMOR Computer B.V. (ABIT's European Office)**
Jan van Riebeeckweg 15, 5928LG, Venlo,
The Netherlands
Tel: 31-77-3204428
Fax: 31-77-3204420
Sales: sales@abit.nl
Web Site: <http://www.abit.nl>

Austria, Czech, Romania, Bulgaria, Slovakia, Croatia, Bosnia, Serbia, and Macedonia **Asguard Computer Ges.m.b.H**
Schmalbachstrasse 5,
A-2201 Gerasdorf / Wien, Austria
Tel: 43-1-7346709
Fax: 43-1-7346713
E-mail: asguard@asguard.at

Shanghai **ABIT Computer (Shanghai) Co. Ltd.**
Tel: 86-21-6235-1829
Fax: 86-21-6235-1832
Web Site: <http://www.abit.com.cn>

Russia and CIS **ABIT Computer (Russia) Co. Ltd.**
Sales: sales@abit.ru
Info: info@abit.ru
Web Site: <http://www.abit.ru>

Poland **ABIT Computer (Poland) Co. Ltd.**
Przedstawicielstwo w Polsce ul. Wita Stwosza 28,
50-149 Wrocław
Tel: 48 71 780 78 65 / 66
Fax: 48 71 372 30 87

Japan Web Site: <http://www.abit4u.jp>

Taiwan Head Office **ABIT Computer Corporation**
*(Serving all other territories
not listed above.
Taiwan is 8+ GMT time,
and may have different holiday
calendar from yours.)*
No. 323, Yang Guang St., Neihu,
Taipei, 114, Taiwan
Tel: 886-2-8751-8888
Fax: 886-2-8751-3382
Sales: sales@abit.com.tw
Marketing: market@abit.com.tw
Web Site: <http://www.abit.com.tw>

7. **RMA Service.** If your system has been working but it just stopped, but you have not installed any new software or hardware recently, it is likely that you have a defective component. Please contact the reseller from whom you bought the product. You should be able to get RMA service there.
8. **Reporting Compatibility Problems to ABIT.** Because of tremendous number of email messages we receive every day, we are forced to give greater weight to certain types of messages than to others. For this reason, any compatibility problem that is reported to us, giving detailed system configuration information and error symptoms will receive the highest priority. For the other questions, we regret that we may not be able to reply directly. But your questions may be posted to the Internet news group in order that a larger number of users can have the benefit of the information. Please check the news group from time to time.

Thank You

ABIT Computer Corporation

<http://www.abit.com.tw>