

■ ***ELSA MainActor***

© 1999 ELSA AG, Aachen (Germany) and MainConcept Mönig/Zabel GbR, Aachen (Germany)

While the information in this manual has been compiled with great care, it may not be deemed an assurance of product characteristics. ELSA shall be liable only to the degree specified in the terms of sale and delivery.

The reproduction and distribution of this handbook and the use of its contents, as well as that of the software included with the product, is subject to ELSA written authorization. The right to modifications in the interest of technical progress is reserved.

ELSA is EN-ISO 9001 certified. The accredited TÜV CERT certification authority has confirmed ELSA conformity to the worldwide ISO 9001 standard in certificate number 09 100 5069, issued on 16 May 1995.

Trademarks

Windows[®], Windows NT[®] and Microsoft[®] are registered trademarks of Microsoft, Corp.

All other names mentioned may be trademarks or registered trademarks of their respective owners. The ELSA logo is a registered trademark of ELSA AG. Subject to change without notice. No liability for technical errors or omissions.

ELSA AG
Sonnenweg 11
52070 Aachen
Germany
Internet www.elsa.de

ELSA Inc.
2231 Calle De Luna
Santa Clara, CA 95054
USA
Internet www.elsa.com

Aachen, July 1999



Contents

Introduction to MainActor	1
What is MainActor?	1
What do I need to use MainActor?.....	2
Using the User's Guide	2
What This Guide Is Not.....	3
Understanding the Terminology.....	3
Installation	5
MainActor Video Editor	9
Starting MainActor Video Editor.....	9
The Lay of the Land.....	9
Getting Help	11
MainActor VE Projects	13
Converting Video Formats.....	13
Creating an Animated GIF.....	15
Extracting Frames from an Animation	20
MainActor Sequencer	23
Starting MainActor Sequencer	23
The Lay of the Land.....	24
Getting Help	25
Context Sensitive Help.....	26
MainActor Electronic Documentation.....	26
*MainActor Sequencer Projects	27
Creating a MainActor Sequencer Project	27
Overlaying Scrolling Text	32
Overlaying 3D Animated Text	37
Adding Effects to a Video Track.....	44
MainActor Video Capture	53
Introduction to MainActor Video Capture.....	53
Files	53
Frames.....	53
Video Format	53
Audio Format.....	53
The Video Capture Application	54
The Lay of the Land.....	54
How to view the input signal	54
How to capture a single frame	54

How to capture a frame sequence	54
How to capture video	55
Settings	55
Video Capture Tutorial	55
Video Capture Tips	56
<hr/>	
Appendix A	59
Supported File Formats	59
Loader Modules	59
Saver Formats	64
<hr/>	
Appendix B	71
MainActor VE Command Reference	71
Menu List Commands	71
Project	74
Frames	76
Settings	78
Help	81
The Save Window	82
<hr/>	
Anhang C	85
MainActor Sequencer Command Reference	85
Menu Commands	85
<hr/>	
Index	89

Introduction to MainActor

Welcome to MainActor, a Video Editing and Sequencing suite for Windows NT, Windows 98, Windows 95, and OS/2 Warp. This User's Guide will help you learn to use the various tools and features in this suite

What is MainActor?

MainActor is a computer program that allows you to edit and sequence multimedia videos. With MainActor, it is possible to perform many of the same tasks that professional video production studios do when they are preparing film for broadcast.

With MainActor, it is possible to:

- Capture video from tape (with the proper computer hardware and interface cabling);
- Create web animations;
- Splice various file formats (QuickTime movies, Windows AVIs, MPEGs) into one large file;
- Edit and clean up home movies;
- Create slide shows and presentations;
- Play almost any video format available today;
- And more.

The MainActor suite consists of four separate programs. Each of these programs performs different tasks, and together they allow you to do almost anything with recorded media.

MainActor Video Editor (VE) allows you to work with animation's on a frame-by-frame basis. Using MainActor VE, you can extract frames from videos to use as stills in other projects, assemble frames for a hand-drawn animated movie or a web animation, even convert animation's from one file format to another.

MainActor Sequencer allows you to combine multiple animation's in one project, as well as add text overlays, create special effects like fades and wipes, and add musical scores and other sound effects.

MainView is a module used by MainActor VE and MainActor Sequencer that can play almost every single animation format available today. MainView can also be called up on its own... you can even use it as your default media player!

MainActor Video Capture is used to capture video using your video capture hardware equipment.

What do I need to use MainActor?

To use MainActor, you need at least a Pentium level PC running Windows 95, Windows 98, Windows NT or OS/2. The more powerful your processor, the better MainActor will run on your machine.

Some computer chips have access to special instructions that aid in the rendering of certain kinds of multimedia formats. This instruction set, called MMX, can be exploited by MainActor: if you have an MMX Machine, certain functions and commands will take less time to perform.

Editing and rendering animations can be very system intensive. It's safe to say that even if you're able to run the program, actually doing anything with it on low-powered machines will be a very, very uncomfortable process. More powerful and faster processors (such as the Pentium II or the AMD K6-2), machines with large amounts of RAM, and hard drives with high access speeds will be better able to handle the large volumes of data required when trying to use fancy video effects and transitions.

If you want to use MainActor to capture and store video on your computer, you need a compatible video capture card and the proper cabling in order to transfer the data correctly. If you received this program with an ELSA graphics card you should have the hardware you need. You do not need this equipment to use the rest of MainActor's capabilities.

Finally, MainActor requires DirectX to function properly when run on a Microsoft Operating System. If you are using the original version of Windows 95, you will have to install DirectX. The latest version of DirectX can be downloaded from Microsoft's Web site. If you are using the original version of Windows NT, Service Pack 3 or 4 will give you the DirectX support needed to run MainActor.

Using the User's Guide

- There are seven chapters in this guide:
- **Chapter 1:** Introduction, which is the section you are reading now, will give you some background information about MainActor, and introduce you to some of the concepts you will need to know before you start.
- **Chapter 2:** Installation shows you how to install MainActor from the CD-ROM.
- **Chapter 3:** MainActor Video Editor (VE) introduces you to the MainActor VE module, and explains the various components and areas of the MainActor VE main window.
- **Chapter 4:** MainActor VE Projects sets up some "real life" tasks using MainActor VE.
- **Chapter 5:** MainActor Sequencer introduces you to the MainActor Sequencer module, and explains the various components and areas of the main window and

some satellites. and shows you how to use many of its powerful sequencing features by taking you step by step through a series of projects.

- **Chapter 6:** MainActor Sequencer Projects sets up a number of “real life” tasks using MainActor Sequencer.
- **Chapter 7:** MainActor Video Capture teaches you how to use the video capturing software that comes with MainActor (for the Windows platforms only).

What This Guide Is Not

The User's Guide is not intended to be a full-fledged user's manual, with complete listings of every feature included in MainActor. Instead, it is intended to be a tutorial that will give you a basic understanding of all the components within the MainActor Suite. After reading this guide you will be able to use MainActor for many tasks, and you will be able to figure out how to use it for many more.

Once you have gone through this guide, you may want to download the user's manual from MainConcept's web site (www.mainconcept.com in the US and www.mainconcept.de in Germany). This manual has an in-depth listing of the various functions and file formats supported by MainActor.

Understanding the Terminology

MainActor, and therefore this User's Guide, has a specific vocabulary that it uses when referring to certain things. To avoid confusion later on in this guide, the most technical terms are listed here:

- **Animation.** Any kind of moving picture that is stored and played on a computer. Animations range from roughly drawn stick figures, to cartoons (such as the cartoons seen on TV, or at the movies), to live TV shows, to full-blown movies.
- **Audio.** Any sound connected with an animation.
- **Frame.** Animation's are not really moving pictures, they are actually a series of still pictures shown in rapid succession, giving the illusion of movement. Each of these still pictures, the smallest complete unit of an animation, is called a frame.
- **Module.** One of the three MainActor components in the suite: either MainActor VE, MainActor Sequencer, or MainView.
- **Project.** Any animation that is open and is being actively worked on.

Installation

Before you can run MainActor, you first must install it on your machine. This section will walk you through the installation process.

As mentioned previously, MainActor for the Microsoft operating systems requires DirectX in order to function properly. DirectX can be downloaded from Microsoft's web site, and NT users will receive DirectX support in Service Packs 3 or 4.

1. From your Windows desktop, insert the MainActor CD-ROM into your CD-ROM drive. If Autoplay is enabled (the default), then the installation program will start by itself. If the installation does not automatically start, you will have to start it yourself. With the CD inserted into your CD-ROM drive, double-click on the CD-ROM object in your My Computer folder. Then double-click on the file named Setup.

RESULT: The Welcome Panel appears.

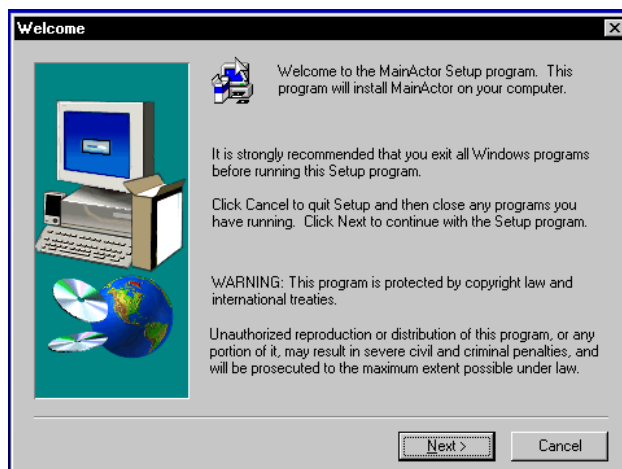

2. Close down any other Windows programs you may be running, then click **Next**.

RESULT: The Software License Agreement Panel appears.

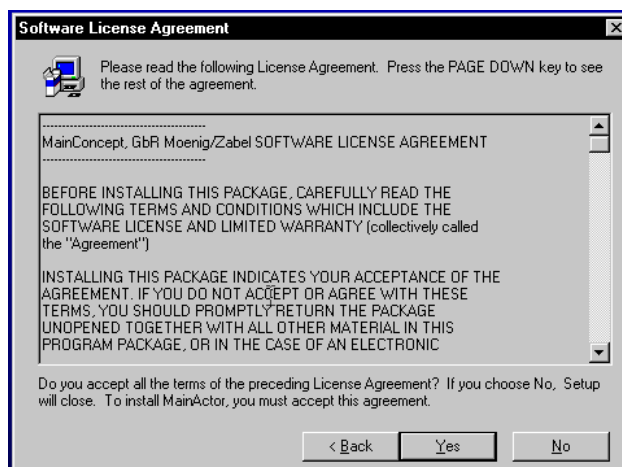

If you agree to the terms of the Software License Agreement, click **Yes**. If not, click **No**. If you click Yes, the User Information Panel appears.

NOTE: If you click No, you will not be able to install the program.

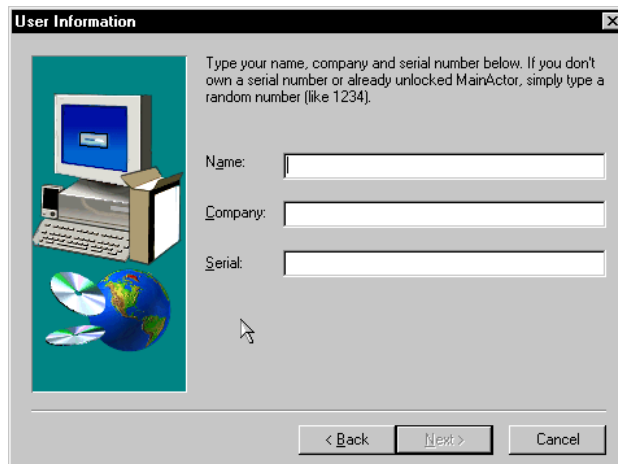

The 'User Information' dialog box has a title bar with a close button. On the left is a graphic of a computer monitor, keyboard, mouse, and CD-ROMs. The main area contains the following text: 'Type your name, company and serial number below. If you don't own a serial number or already unlocked MainActor, simply type a random number (like 1234)'. Below this are three text input fields labeled 'Name:', 'Company:', and 'Serial:'. At the bottom are three buttons: '< Back', 'Next >', and 'Cancel'.

3. On the user Information Panel, enter your name, your company name (if applicable) and the serial number that came with the CD.

NOTE: The **Next** button will be grayed out until you enter the correct serial number.

4. Click **Next**.

RESULT: The Choose Destination Location Panel appears.

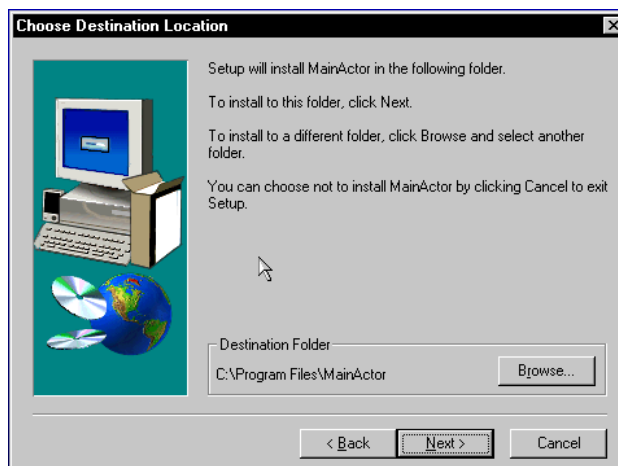

The 'Choose Destination Location' dialog box has a title bar with a close button. On the left is a graphic of a computer monitor, keyboard, mouse, and CD-ROMs. The main area contains the following text: 'Setup will install MainActor in the following folder. To install to this folder, click Next. To install to a different folder, click Browse and select another folder. You can choose not to install MainActor by clicking Cancel to exit Setup.' Below this is a text box labeled 'Destination Folder' containing 'C:\Program Files\MainActor' and a 'Browse...' button. At the bottom are three buttons: '< Back', 'Next >', and 'Cancel'.

5. The Choose Destination Location Panel will install MainActor to the C:\Program Files\MainActor directory by default. If you'd like to install the program to a different directory or on a different hard drive, click Browse... A dialog box will appear that will allow you to specify the new location. When you are ready to start the installation program, click **Next**.

RESULT: The Select Program Folder Panel appears.

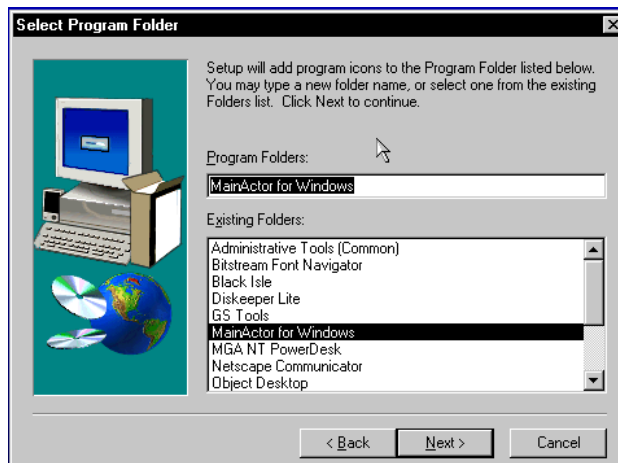

6. The install program will create a program folder for MainActor called "MainActor for Windows" by default. This will be located in the Start Button programs list so that MainActor may be started conveniently. If you would like to name the program folder something else, type in the new name in the highlighted text field. Click **Next**.

RESULT: The Select Components Panel appears.

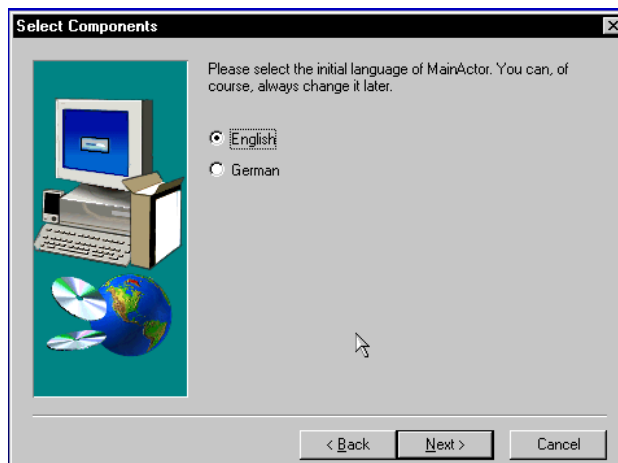

7. At the Select Components Panel, choose the language you want MainActor to use by default (either English or German). Click **Next**.

RESULT: The install program starts.

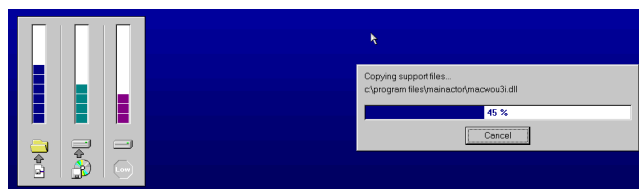

8. At the end of the install program, you will have the opportunity to launch a readme file that provides updates and last minute information about the product. You'll also

have the opportunity to launch the program itself. Click **Finish** to complete the install program.

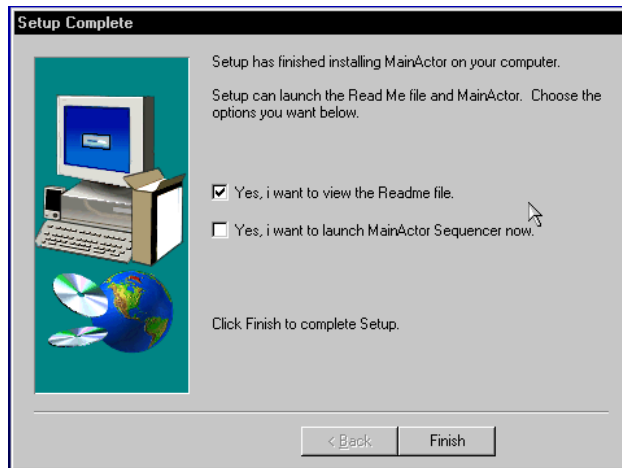

Setup is now complete.

MainActor Video Editor

The MainActor Video Editor (or MainActor VE) module was designed to work with one animation at a time. While it is not as flexible or as powerful as MainActor Sequencer, it is useful for many things for which MainActor Sequencer is simply too large and unwieldy.

In this section, you will learn to:

- Identify and use the various areas of the MainActor VE screen;
- Open and move between multiple projects;
- Convert a project from one video format to another;
- Create a slide show;
- Create an animation; and
- Extract frames from an animation.

Starting MainActor Video Editor

To start MainActor VE, click the Windows Start button. Then, in the Programs directory, look for a folder called MainActor V3. In that folder, click on the MainActor icon. MainActor VE will load.

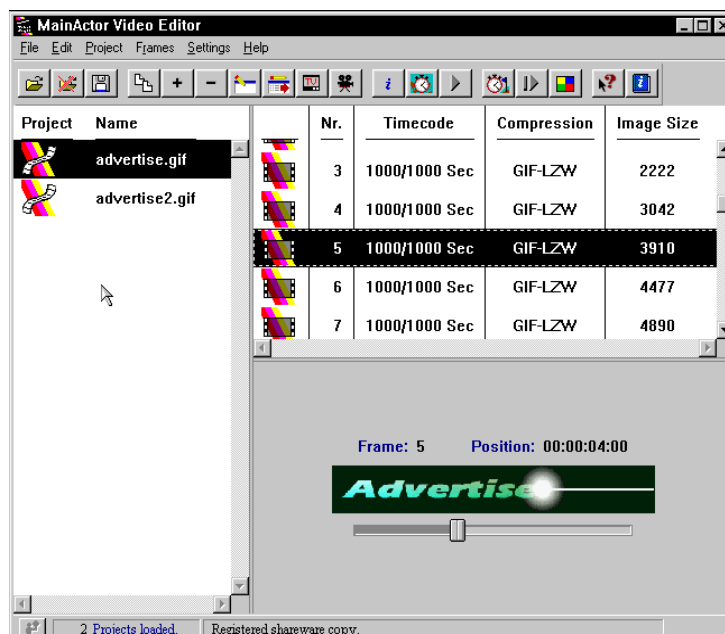

The Lay of the Land

The MainActor VE screen is separated into 5 distinct regions.

The Menu

The Menu contains every command available to MainActor VE. Many of the menu entries also have keyboard shortcuts (so you can activate a command via a key combination rather than searching through nested directories). See Appendix B for a detailed description of the menu items.

The Toolbar

The Toolbar places some of the more commonly used functions within easy reach. When a button is not grayed out, you may use it in place of an entry on the Menu.

The Toolbar features integrated fly-over help banners. If you let your mouse pointer hover over any button on the Toolbar, a little banner will appear next to it identifying the button by name.



The Project List

The Project List keeps track of how many files you have opened in MainActor VE.

While you can only work on one project at a time, you may have more than one open and ready to be worked on. Clicking on a project in the Project List makes it “active” and causes its contents to be listed in the Frame List (below).

The Frame List

The Frame List displays the contents of the active project. When an animation is opened in MainActor VE, it is broken down into still pictures and displayed sequentially here. This allows you to view the animation as if it were a slide show. Whenever a frame is highlighted in the Frame List, the picture is displayed in the preview window (below).

The Preview Window.

The Preview Window gives you an idea of what the finished project will look like. MainActor VE can use the Preview Window to play through the entire product, frame by frame, or display individual frames.

Area Sensitive Mouse Menus

It is also possible to access certain commands in MainActor VE by right-clicking with your mouse over the different window areas. Right-clicking over the Project List, for example, allows you to open a new project.



Right-clicking on a project in the Project List allows you to, among other things, play the project via MainView.

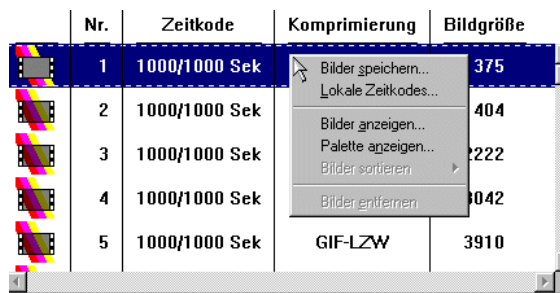

Right-clicking on a frame in the Frame List allows you to modify its properties.

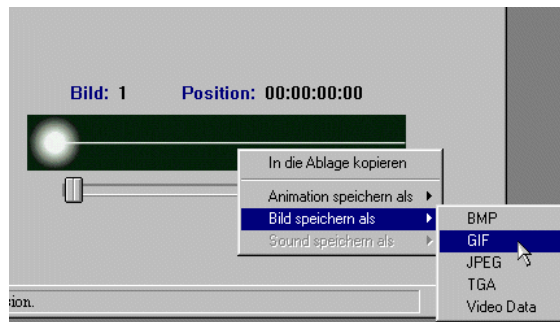

Getting Help

There will always be times when you don't know or can't remember a) what a tool does, and b) where it is. In these situations, MainActor VE can assist you by providing you information about the tools you're using. There are two ways to get help in MainActor VE:

- Context Sensitive Help, which allows you to see some information on a tool or area without actually having to go into the help area, and
- MainActor Electronic Documentation, which is essentially an electronic user's manual for the entire MainActor suite.

Context Sensitive Help

This is an extension of the fly-over help idea already present in the Toolbar. When you choose **Help ► Context Sensitive Help** from the menu, or click the Context Sensitive Help button on the Toolbar, your mouse changes from a pointer into a question balloon. You can click this question balloon over any part of MainActor VE and a brief description of the area or tool, and what it is used for, will appear.

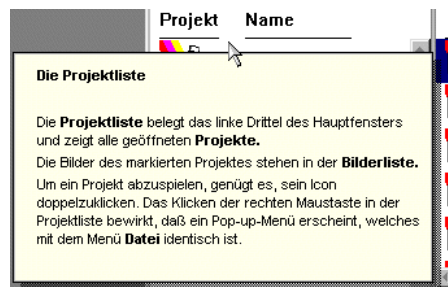

MainActor Electronic Documentation

When you need to more in-depth information than the Context Sensitive Help tool will give you, you can call up a complete electronic manual that covers every facet of MainActor VE, MainActor Sequencer and MainView. Choose **Help ► MainActor Documentation** or click the **Show Documentation** button on the toolbar to access this information.

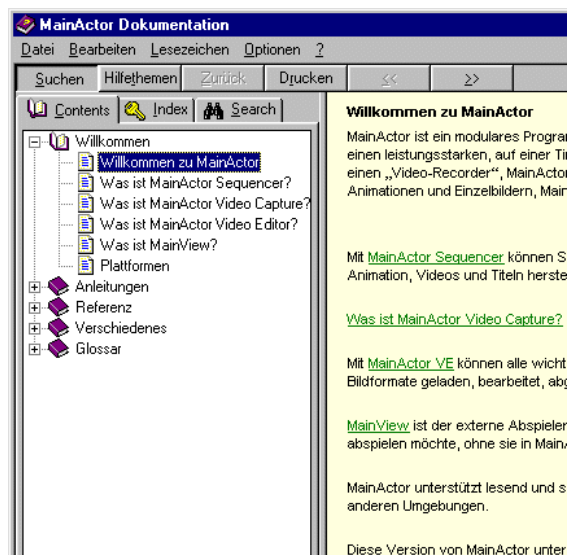

MainActor VE Projects

To give you an idea how MainActor VE can be used in day-to-day situations, we have prepared three scenarios where MainActor VE is needed to accomplish a task. Read the project scenarios, and then go through them on your own to familiarize yourself with the way MainActor VE works.

Converting Video Formats

Scenario: You're sitting at your computer, minding your own business, when suddenly your boss comes storming into your cube and throws a shiny CD-ROM on your desk.

"This thing is in MPEG format!" he growls.

"...ok..." you say cautiously, trying not to stir him up any further. "What is it?"

The Boss sighs in irritation. "It's the commercial we filmed a few days ago. They sent a sample of it via CD-ROM in MPEG format, and I don't have an MPEG player on my computer! Fix it," he adds, and storms off.

You reach for your mouse, and MainActor springs to life...

A very useful aspect of MainActor VE is its ability to open and export to a huge array of animation formats. If you need to "convert" an animation file from one format to another, MainActor will be able to handle this very capably.

Follow the directions below to convert a project from one file format to another:

1. Start MainActor VE.

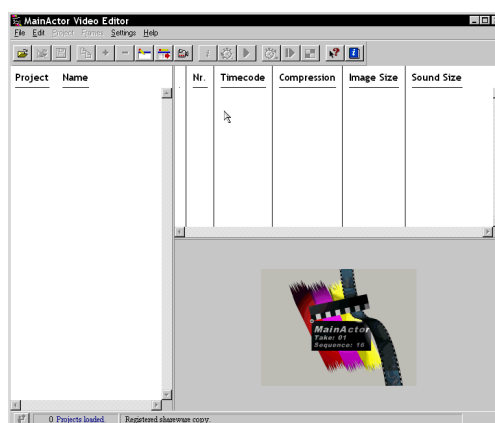

2. From the Menu, choose **File** ► **Open**.

RESULT: The Select Project(s) dialog box opens.

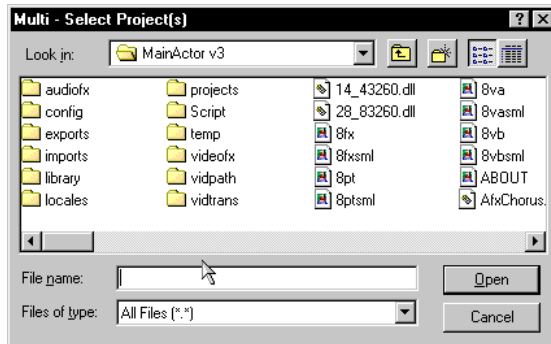

3. In the MainActor /projects/movies directory, select **admpeg**. Click **Open**.

RESULT: Admpeg appears in the Project View area, and its frames are listed in the Frames View.

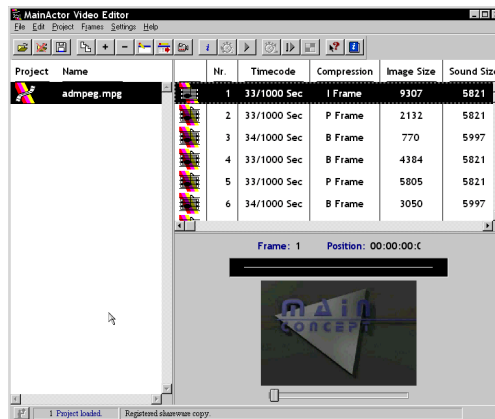

4. From the Menu, choose **File ► Save As...**

RESULT: The Save Window appears. (See Appendix B for a detailed discussion of the Save Window.)

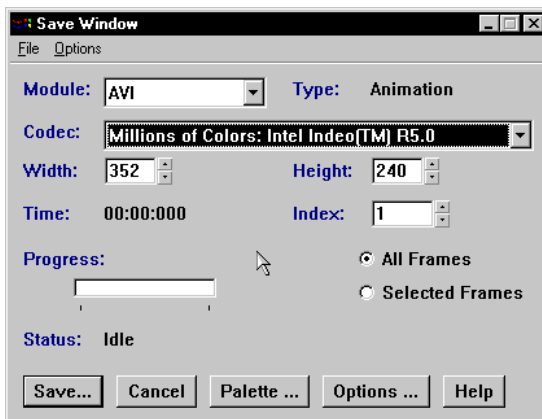

5. In the Module area, make sure that AVI is selected in the list.
6. In the Codec area, choose 'Millions of Colors: Intel Indeo(TM) R5.0' from the drop-down list.

- Click **All Frames**.
- Click **Save...**

RESULT: The 'Select File...' window appears.

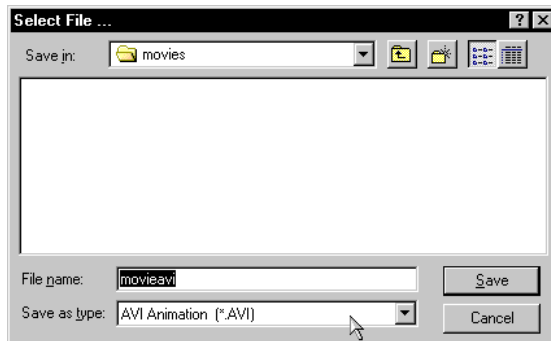

- Save this file in the /projects/webgif directory as adavi.

RESULT: The 'Select File...' window closes, and the 'Save Window' will count up the status of the project rendering in the Status area. When the rendering has finished, adavi will appear in the /projects/webgif directory.

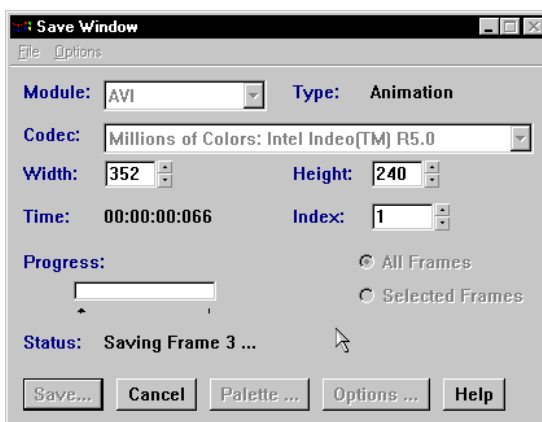

- When the rendering has finished, click **Cancel**.
- Exit the program.

Creating an Animated GIF

Scenario: You've been working on your client's website for a week or two, and you're almost finished. Just as you're about to FTP everything to their web server, the phone rings.

"Uhh, hello, I hope I'm not disturbing you."

You wince as you realize that it is the client, who wants yet another last minute change to his web site.

"Uhh, I was browsing around on the Internet the other day and I saw this really neat site. It had a graphic that you click on to find out about the costs of placing advertisements on their site, and the graphic was animated, so it was really catchy. Could you whip up a nifty advertising banner real quick and put it on my home page? Don't make it too big, though, I don't want people to get tired of waiting for it to load and go somewhere else."

As you hang up the phone, you sigh and reach for your mouse... and your coffee...

One of the things MainActor VE is very good at is taking a series of still pictures and saving them as an animation. Of course, MainActor will only assemble the frames you've created and save them in the correct format: it's up to you to actually create the frames that will be used in the animation itself.

For the purpose of this exercise, we're going to assume you have already created the frames you want to use in your web graphic. These frames are located in the /projects/webgif directory. This procedure will start from the point where you've just finished creating the last frame with your trusty graphics program, and you're ready to start building your animation.

1. Load MainActor VE.

RESULT: The MainActor VE Window appears.

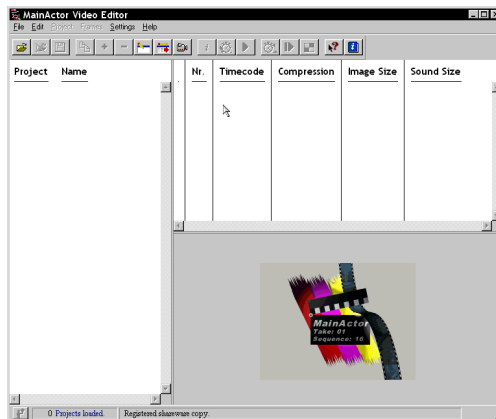

2. From the Menu, choose **File** ► **Open**.

RESULT: The 'Select Project(s)' dialog opens.

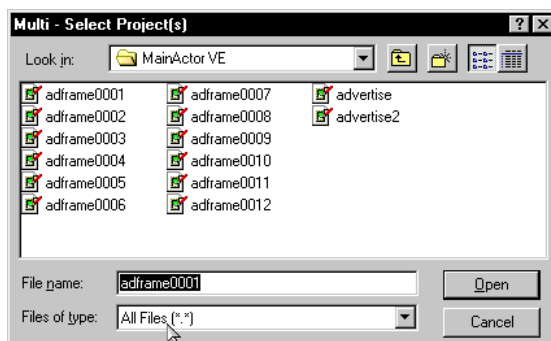

3. Go to the /projects/webgif directory.
4. Select adframe0001 and click **Open**.

RESULT: A dialog box appears with the message 'The picture is part of a picture list. Continue?'
Continue?'



5. When MainActor sees a number of files with the same name and a number attached to them, it assumes that they are all intended to be part of the same animation and will load them in numerical order. Click **Yes**.

RESULT: The frames adframe0001 through adframe0012 are listed in the Frame List. A new project, named GIF, is displayed in the Project List.

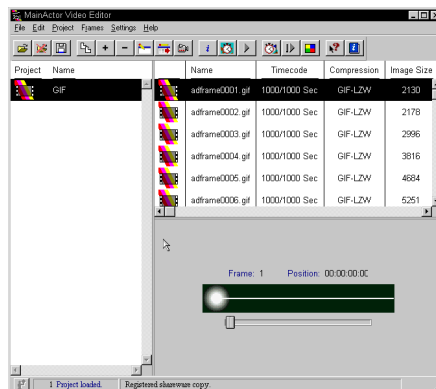

6. In the Project List, right-click on **GIF** and click **Play Project**.

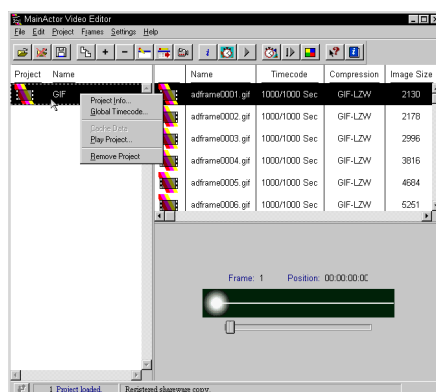

RESULT: The MainView module appears.



7. Press the **play** button to preview the animated GIF.
8. Close MainView.
9. Right-click on **GIF** and click **Global Timecode**.

RESULT: The Global Timecode Dialog Box appears.

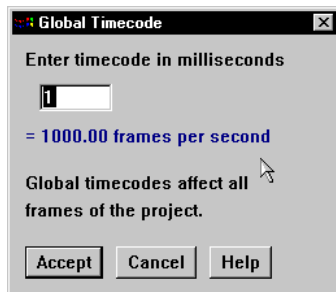

10. Setting the Global Timecode will affect the length of time that each frame is displayed before the next frame appears. Timecodes are measured in milliseconds (1/1000 of a second): for example, if you set the Global Timecode to "10" each frame will be shown for 10 milliseconds before being replaced by the frame that follows it. Setting the Global Timecode to "1000" will cause each frame to be displayed every second. In the Timecode entry field, enter 1000. Click **Accept**.



RESULT: the Global Timecode Dialog Box closes, and the Timecode column in the Frames List will read 1000/1000 Sec.

adframe0001.gif	1000/1000 Sec	GIF-LZW	2130
adframe0002.gif	1000/1000 Sec	GIF-LZW	2178
adframe0003.gif	1000/1000 Sec	GIF-LZW	2996
adframe0004.gif	1000/1000 Sec	GIF-LZW	3816
adframe0005.gif	1000/1000 Sec	GIF-LZW	4684
adframe0006.gif	1000/1000 Sec	GIF-LZW	5251

- From the Menu, choose **File** ► **Save as...**

RESULT: The Save Window appears.

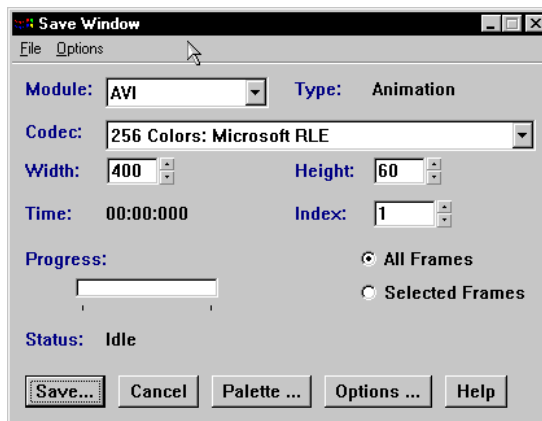

- From the Module drop-down list, choose 'Gif-Anim'.
- Click the **All Frames** radio button.
- Click **Save...**

RESULT: The Select File... dialog box appears.

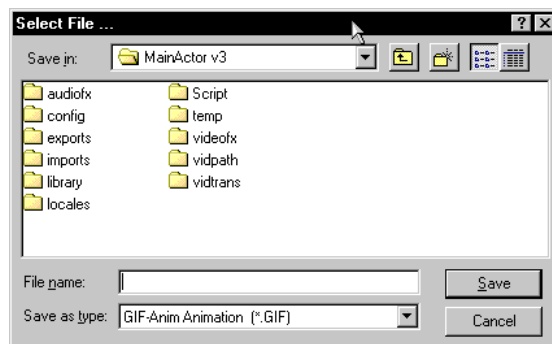

Save the animation in the /projects/webgif directory as webanima.

RESULT: You are returned to the Save Window. The animated gif will be rendered (this may happen so quickly that you don't notice it, depending on the speed of your computer. Animated GIFs are not terribly hard to render and they don't usually require much processing time.

15. Close the Save Window.
16. To close the project without closing MainActor VE, right-click on **GIF** in the Project List and select **Remove Project**.

RESULT: The project is closed, but MainActor VE remains open.

Extracting Frames from an Animation

Scenario: You breathe a sigh of contentment as you look at your beautiful, animated GIF. Then you choke as you realize that your beautiful graphic just added another 40K to the entire web site! Shaking your head, you realize that the GIF is at least twice as large as it needs to be. You're going to have to find a way to cut that sucker in half...

1. Start MainActor.
2. From the Menu, choose **File ► Open**.

RESULT: The Select Project(s) dialog box appears.

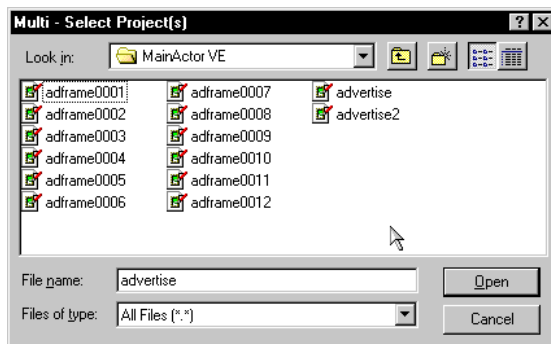

3. In the /projects/movies directory, select webanima and click **Open**.

RESULT: webanima will appear in the Project List, its frames will be listed in the Frames List.

4. In the Frames List, click on **frame 1**.

RESULT: frame 1 will be selected.

	1	1000/1000 Sec	GIF-LZW	1375
	2	1000/1000 Sec	GIF-LZW	1404
	3	1000/1000 Sec	GIF-LZW	2222
	4	1000/1000 Sec	GIF-LZW	3042
	5	1000/1000 Sec	GIF-LZW	3910
	6	1000/1000 Sec	GIF-LZW	4477

5. Press the **CTRL** key on your keyboard. While this key is pressed, click on frames 3, 5, 7, 9, 11 and 12.

RESULT: frames 1, 3, 5, 7, 9, 11 and 12 will be highlighted; frames 2, 4, 6, 8, and 10 will not.

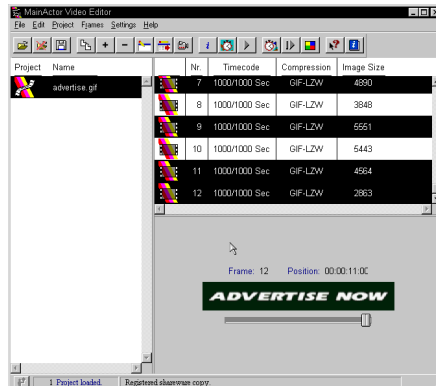

- From the Menu, choose **File** ► **Save As...**

RESULT: the Save Window appears.

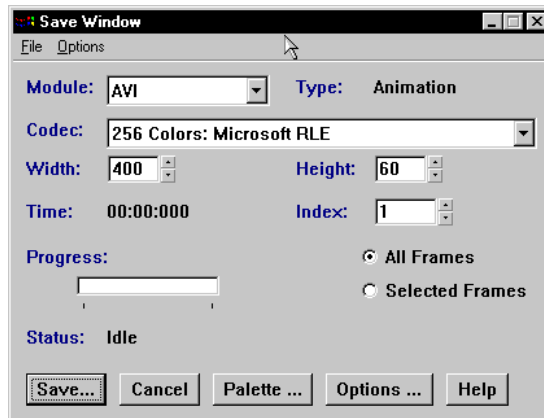

- From the Module drop-down list, choose **GIF Anim**.
- Click **Selected Frames**. This will cause MainActor to use only the frames you selected in the Frames List and discard the others.
- Click **Save...**

RESULT: the 'Select File...' window opens.

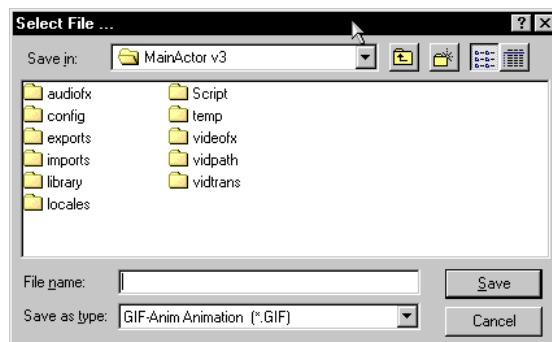

- Save the animation in the /projects/webgif directory as webanima2.

RESULT: The file will be rendered with only half of its original frames, making it roughly half the size of webanima.

- 11.** Close the Save Window and exit the program.

MainActor Sequencer

The MainActor Sequencer module was designed to take multiple animations and combine them, along with text overlays and special audio and visual effects, into one seamless project. MainActor Sequencer is the program that gives you access to a very powerful video effects and processing tool set.

In this section, you will learn to:

- Identify and use the various areas of the MainActor Sequencer screen
- Insert video and audio files into tracks
- Preview your work before rendering
- Overlay text on top of a video file to create a title
- Overlay scrolling text on top of a video file to create a scrolling credits effect;
- Create 3d animated text
- “Crop” a video file
- Add effects to a video file
- Transition between one video file and another
- Add sound to your project.

Starting MainActor Sequencer

To start MainActor Sequencer, click the Windows Start button. Then, in the Programs directory, look for a folder called MainActor V3. In that folder, click on the MainActor Sequencer icon. MainActor Sequencer will load.

The Lay of the Land

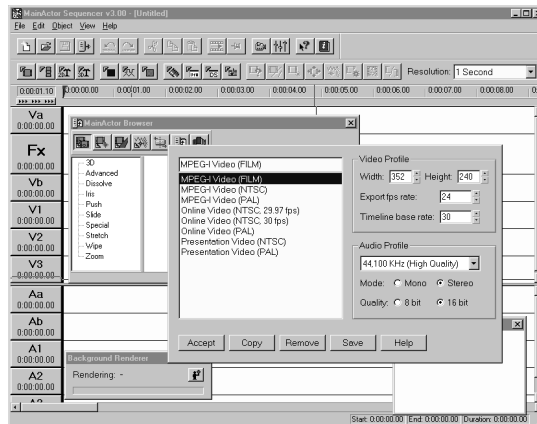

The Menu

The Menu contains every command available to MainActor Sequencer. Many of the menu entries also have keyboard shortcuts (so you can activate a command via a key combination rather than searching through nested directories).

The Toolbar

The Toolbar places some of the more commonly used functions within easy reach. The top row of buttons deals with file-related functions (opening and saving), editing functions (cut, copy, and paste), and program settings. You can also access the online help file from the toolbar.



The second row of buttons on the toolbar is used for functions relating to objects in the Timeline, such as inserting objects and object properties.

The Toolbar features integrated fly-over help banners. If you let your mouse pointer hover over any button on the Toolbar, a little banner will appear next to it identifying the button by name.

The Profile Window

The Profile Window is displayed at program startup and allows you to set the profiles for video and audio. The profiles control the type of video as well as frame sizes and rates and audio quality.

The Preview Window

The Preview Window allows you to view your project before you export it to an animation format. When you press the Show Quick Preview Button (described below), the animation will be displayed.

Because the animation is being played “on the fly,” it will usually play very slowly. Also, the previewed animation will not include sound, even if there is sound in your project.

The Background Renderer

The Background Renderer, when turned on, allows MainActor to render the animation “behind the scenes” while you work on other things.

The MainActor Browser

The MainActor Browser allows you to apply numerous fades, transitions and special effects to your animation.

The Show Quick Preview Button

When this button is pressed, a preview of the animation project is displayed in the Preview Window.

The Timeline

The Timeline shows the various graphic, sound and text objects that make up your project. At the top of the timeline is a scale which is similar to the ruler used in a word processor. It indicates the point in time for a particular location in the Timeline. This enables you to easily tell at what point a particular part of an animation will start and how long it will last.

Tracks

Tracks are used to hold graphic, sound, and text objects. Tracks extend horizontally across the timeline. The Va and Vb tracks are used for transitions and effects that involve two objects, such as fading from one graphic to another. The Fx track holds the transition or effect objects that are used by Va and Vb. The V1, V2, V3, etc. tracks are also known as Overlay Tracks because objects in them are overlaid on (i.e., placed on top of) the objects in the Va and Vb tracks.

The Aa, Ab, A3, etc. tracks are the sound tracks that correspond to the video tracks. With its intuitive interface, mainActor makes it easy to match sounds with sections of video.

The Status Area

The Status Area displays basic information about the project -- when it starts, when it stops, and how long the animation lasts. It can also display information such as the coordinates and name of an object within the project.

Getting Help

There will always be times when you don't know or can't remember a) what a tool does, and b) where it is. In these situations, MainActor Sequencer can assist you by providing

you information about the tools you're using. There are two ways to get help in MainActor Sequencer:

- **Context Sensitive Help**, which allows you to see some information on a tool or area without actually having to go into the help area, and
- **MainActor Electronic Documentation**, which is essentially an electronic user's manual for the entire MainActor suite.

Context Sensitive Help

This is an extension of the fly-over help idea already present in the Toolbar. When you choose **Help ► Context Sensitive Help** from the menu, or click the Context Sensitive Help button on the Toolbar, your mouse changes from a pointer into a question balloon. You can click this question balloon over any part of MainActor Sequencer and a brief description of the area or tool, and what it is used for, will appear.

MainActor Electronic Documentation

When you need more in-depth information than the Context sensitive Help tool will give you, you can call up a complete electronic manual that covers every facet of MainActor VE, MainActor Sequencer and MainView. Choose **Help ► MainActor Documentation** or click the Show Documentation button on the toolbar to access this information.

*MainActor Sequencer Projects

To give you an idea how MainActor Sequencer can be used in day-to-day situations, we have prepared nine scenarios where MainActor Sequencer is needed to accomplish a task. Read the project scenarios, and then go through them on your own to familiarize yourself with the way MainActor Sequencer works.

Creating a MainActor Sequencer Project

Scenario: Your boss' words hang in your mind: "Create something interesting for our presentation next week."

"Like what?" you ask.

Your boss shrugs. "I don't know. Something interesting."

In this scenario, you will:

- Insert an existing animation into a new MainActor Sequencer project;
- Add some introductory text to the beginning of the project;
- Preview your work; and
- Export the project to an AVI file.

For this project, we are going to use a version of the web animation you created in Chapter 4.

1. Start MainActor Sequencer.

RESULT: MainActor Sequencer appears, and the Profile Window opens.

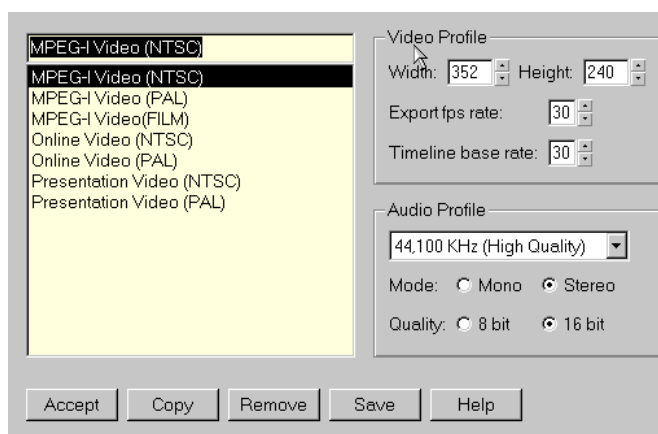

2. The Profile Window allows you to define the video and audio settings in your project. From this window, you can control the type of video, the frame sizes, frame rates, and the general audio quality of your project. In the listbox on the left, highlight MPEG-I Video NTSC.

3. Click **Accept**.

RESULT: The Profile Window closes.

4. From the Toolbar, click the **Insert Multimedia...** button.



RESULT: The Select file(s)... dialog appears.

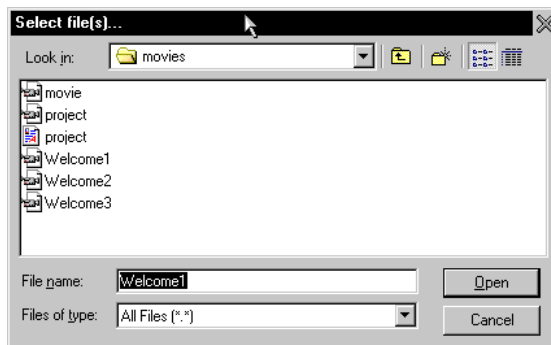

5. In the /projects/movies directory, select advertise and click **Open**.

RESULT: The Select file(s)... dialog closes.

6. Move your mouse into the Va track.

RESULT: Your mouse pointer will change shape -- it will have a tiny film clip at the end of it. Also, a large gray rectangle will follow it (the gray rectangle represents the film clip you have just opened.)

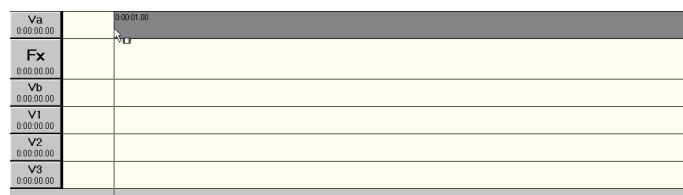

7. The gray rectangle will have a time signature in the upper left hand corner. This time signature represents when in the project the animation will start. Drag the mouse along the Va track until the time signature reads 0:00:01.00, then click on the left mouse button.

RESULT: The animation is inserted into the Va track at 0:00:01.00.

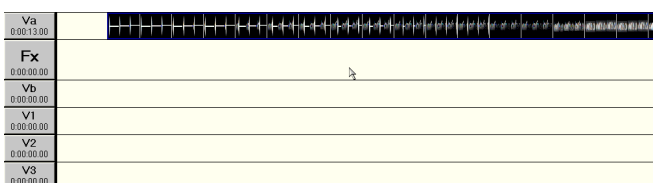

- 8. From the Toolbar, click the **Insert 2D Text Object...** button.



RESULT: The Text Object Configuration Window and the Text Preview Window appear.

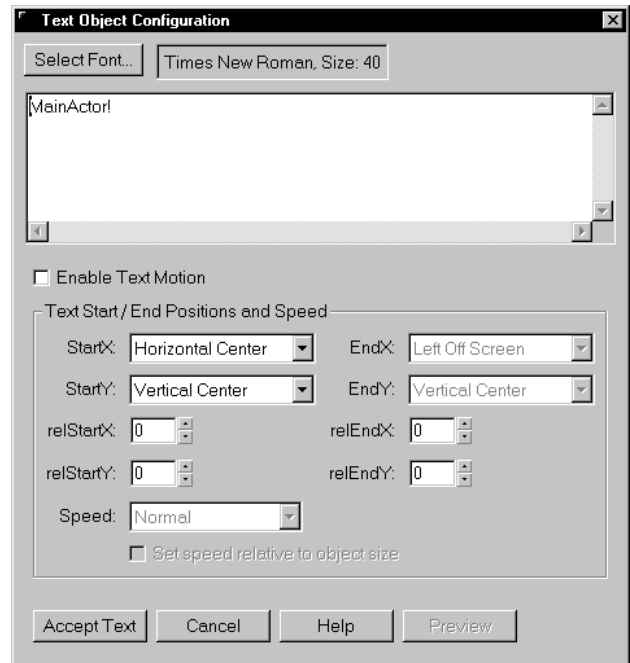

- 9. In the Text Object Configuration Window, highlight the text "MainActor!" and replace it with the text "Introducing."

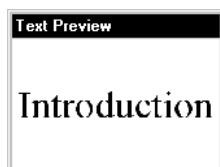

RESULT: The text preview window will be updated with the new information

- 10. Click **Accept Text**.

RESULT: The Text Object Configuration Window and the Text Preview Window close.

- 11. Move your mouse onto the V1 track.

RESULT: Your mouse pointer will change shape -- it will have a tiny "T" at the end of it. Also, a gray rectangle will follow it (the gray rectangle represents the text clip you have just created.)

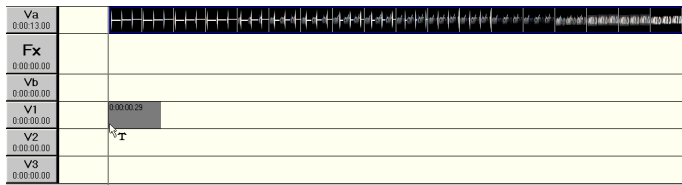

12. The gray rectangle will have a time signature in the upper left hand corner. This time signature represents when in the project the animation will start. Drag the mouse along the V1 track until the time signature reads 0:00:00.00, then click on the left mouse button.

RESULT: The text is inserted into the V1 track at 0:00:00.00.

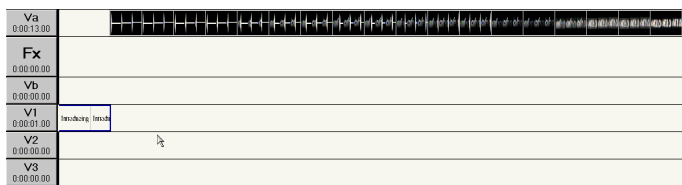

13. From the Menu, choose **File ▶ Save as...**
14. Result: the Select Sequencer Project... dialog appears.



15. Save your project in the /projects directory as firstvideo, then return to the main screen.
16. Click the **Show Quick Preview** button.

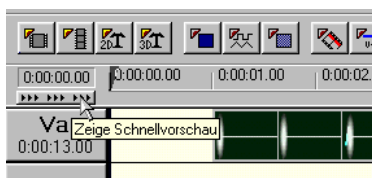

RESULT: the Preview Window will show you a “rough take” of what the final animation will actually look like.

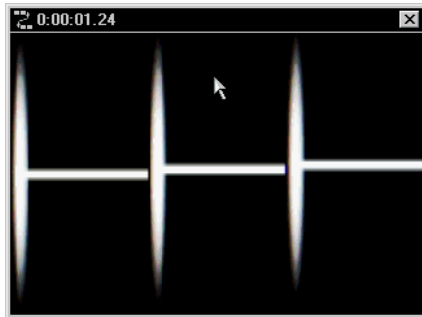

The animation will look very warped and distorted. This is because the web animation, which was created as an ad banner (roughly 100 pixels wide by 60 pixels high) is being distorted to match the 352x288 screen size of a standard video display.

17. From the Menu, choose **File ▶ Export...**

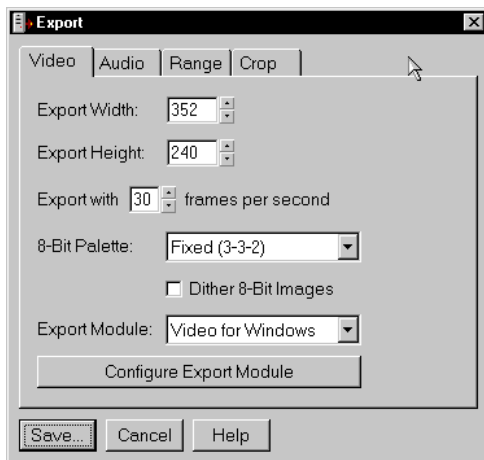

RESULT: The Export dialog appears.



The Export dialog has four tabs: Video, Audio, Range, and Crop. Each tab allows you to modify various aspects of the animation before you export it into a “real” video format. Video determines what size the animation will be and what technology will be used when the new format is created. Audio determines the quality of the sound of the animation (if any exists). Range allows you to specify whether you want to export the entire project, or only a segment of it. Crop allows you to reduce the viewable screen area in the animation.

18. Click **Save...**

RESULT: The Select file... dialog appears.

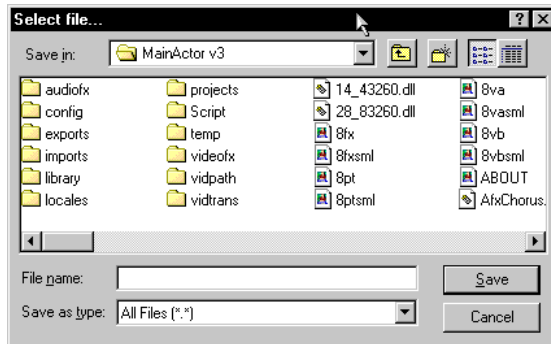

19. Save your file in the /projects/movies directory as firsttry. Click **Save**.

RESULT: the Export Progress dialog appears. When the project has finished exporting, the Export Progress dialog will close.



20. Close MainActor Sequencer

Overlaying Scrolling Text

Scenario: "Yes, well, it's very nice," your boss tells you, "but it's missing something."

You clench your teeth. "What exactly is it missing?" You manage to say it without raising your voice.

"I don't know," he says. "Maybe you could put some credits at the end of the film."

"Credits?" You're not as successful at keeping your voice down this time. "At the end of a 20 second video?"

"Yeah," your boss says, oblivious. "And make 'em scroll up like they do in the movies. Have it ready by tomorrow, I'm going out to play golf."

Creating movie-styled credits (where the list of credits scroll past the screen, from bottom to top) is very simple. All you need to do is enter the text in one 2d text window and set it to move from the bottom to the top of the screen.

1. Open MainActor Sequencer.

RESULT: The Profile Window appears.

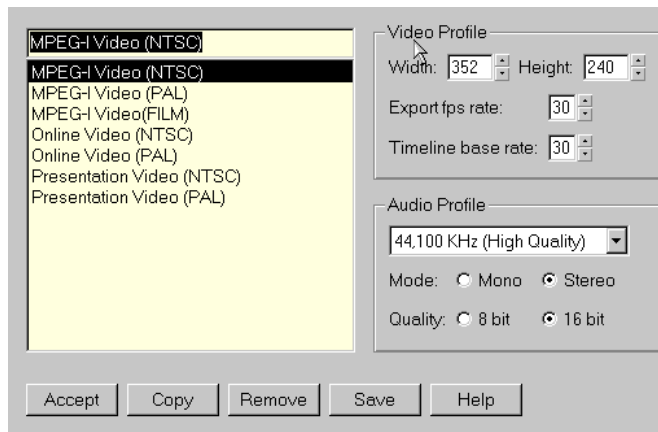

2. Click **Accept**.

RESULT: The Profile Window closes.

3. From the Menu, choose **File ▶ Open...**

RESULT: the Select Sequencer Project appears.



4. From the /projects directory, choose firstproject.

5. Click **Open**.

RESULT: the project you created in the last scenario is loaded into MainActor.

6. From the Toolbar, click the **Insert 2D Text Object...** button.



RESULT: The Text Object Configuration Window and the Text Preview Window appear.

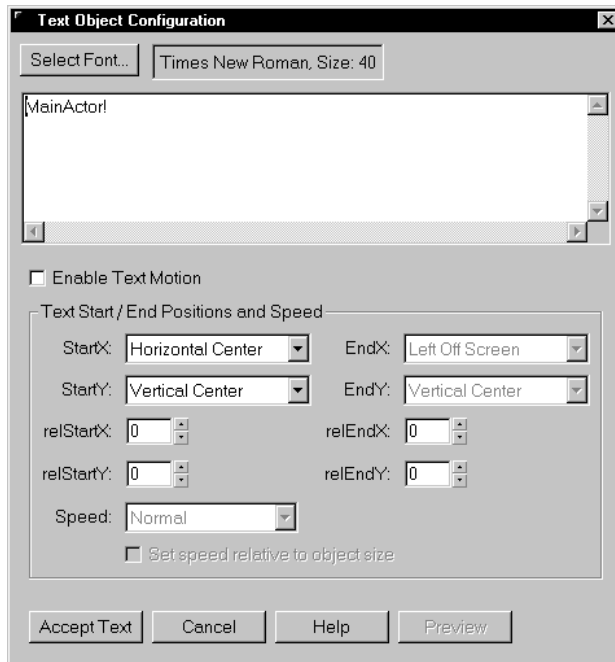

7. Replace the text "MainActor!" with the following text (make sure to include the spaces between the lines).

By:
Me

Animation:
Me

Direction:
Me

Storyline:
Me

Costumes:
Me

8. Click **Enable Text Motion**.
9. Set the StartX droplist to display Horizontal Center.
10. Set the EndX droplist to display Horizontal Center.



You have just configured the text to scroll through the middle of the screen.

11. Set the StartY droplist to display Bottom Off Screen.
12. Set the EndY droplist to display Top Off Screen.



You have just configured the text to scroll through the viewable area from bottom-to-top.

RESULT: the Text Object Configuration Window should look like this:

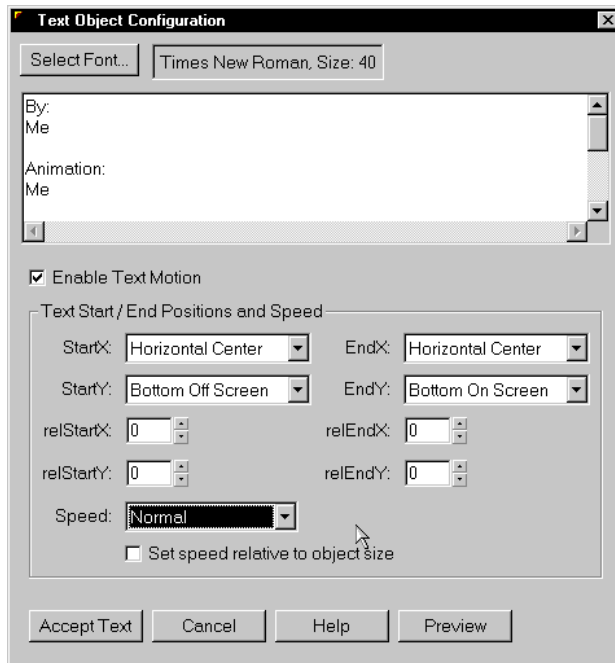

The Text Preview Window should be empty.

13. Click **Accept Text**.

RESULT: The Text Object Configuration Window and the Text Preview Window close.

14. Move your mouse onto the V1 track.

RESULT: Your mouse pointer will change shape -- it will have a tiny "T" at the end of it. Also, a long gray rectangle will follow it (the gray rectangle represents the scrolling text you have just created)

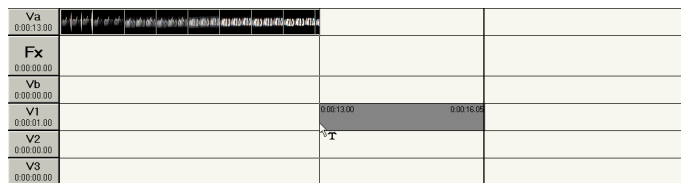

15. The gray rectangle will have a time signature in the upper left hand corner. This time signature represents when in the project the animation will start. Drag the mouse along the V1 track until the time signature reads 0:00:13.00, then click on the left mouse button.

RESULT: The animation is inserted into the V1 track at 0:00:13.00.

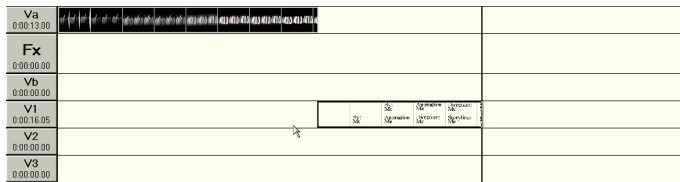

16. from the Menu, choose **File ▶ Save as...**

RESULT: the Select Sequencer Project... dialog appears.



17. Save your project in the /projects directory as secondvideo, then return to the main screen.
18. Click the **Show Quick Preview** button.

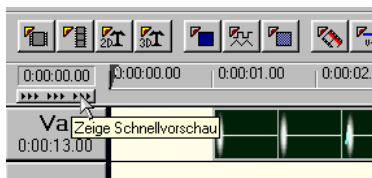

RESULT: the Preview Window will show you a "rough take" of what the final animation will actually look like.



The animation will look identical to the one you created in your last example, except that your scrolling credits will be tacked on to the end.

19. Export this file the same way you did in the last scenario, only name this one secondry.

20. Close MainActor Sequencer.

Overlaying 3D Animated Text

Scenario: "Our competitor won the account. Their presentation had scrolling text in 3D. I think that's what clinched it."

You force back the first twenty responses that spring to mind. Instead, you just say, "really?"

Your boss nods. "Add something in 3D to our next presentation," he says. "I'm going out to play golf!"

MainActor Sequencer allows you to create three dimensional animated text and insert it into your project. In this scenario we will briefly describe how to modify a 3D animated text clip.

Because there is an awful lot you can do with 3D text, this scenario will give you only a general idea on how to create and insert 3D text into a project. We suggest you experiment with this tool yourself to get a good idea of the capabilities of this option.

1. Open MainActor Sequencer.

RESULT: The Profile Window appears.

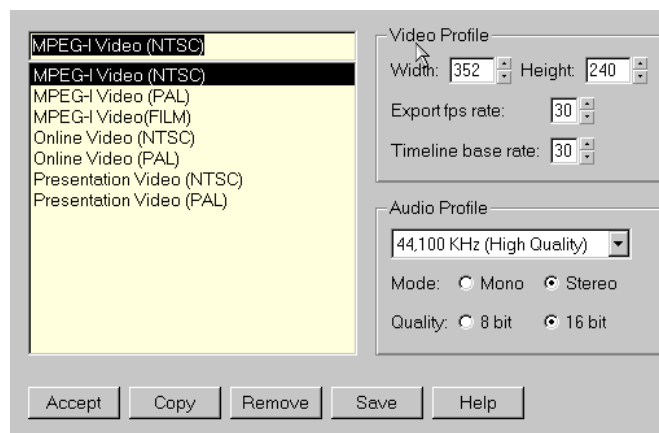

2. Click **Accept**.

RESULT: The Profile Window closes.

3. From the Button Bar, click the **Insert 3D Text Object** button.



RESULT: the 3D Text Configuration Window appears.

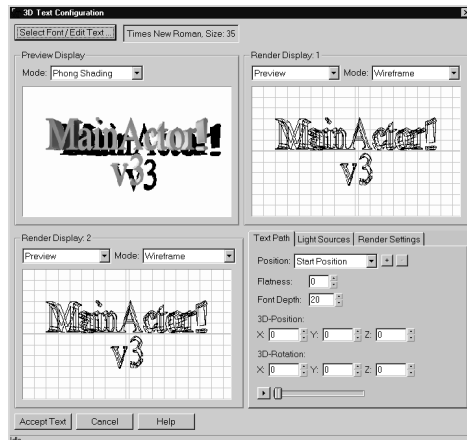

The 3D Text Configuration Window is split into six sections. The top of the window has the Select Font/Edit Text button, which takes you to a dialog that will allow you to specify the typeface, size and message that will be rendered in 3D. The bottom of the window has the Accept, Cancel and Help buttons. Accept will create the 3D text based on the settings in this window. Cancel will close the 3D Text Configuration Window without applying any of the settings. Help will open a help screen that you can refer to if you need more information on any of the tools here.

The rest of the window is split into four quadrants. The first three quadrants, Preview Display, Render Display 1, and Render Display 2, allow you to view the animation from up to three different perspectives or methods of shading.

The fourth quadrant has settings for global characteristics of the 3D text object. This allows you to define, for example, how many light sources are shining on the text (affecting the shadows). It also allows you to define the animation path of the text.

4. In Render Display 1, click the left drop-down list and choose Y-Z Axis.

RESULT: The Render Display 1 area will show the text from a side perspective.

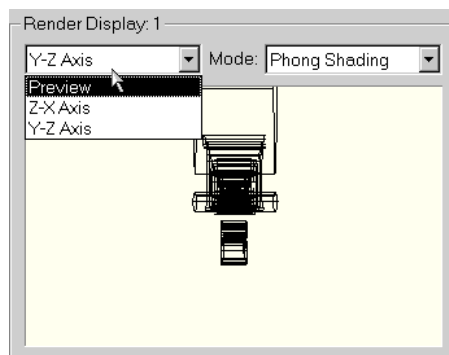

5. In Render Display 2, click the left drop-down list and choose X-Y Axis.

RESULT: The Render Display 2 area will show the text from an overhead perspective.

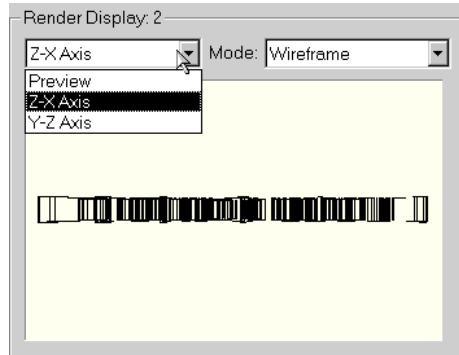

The **MODE** drop-down list in the Preview Display, Render Display 1 and Render Display 2 areas will change the type of rendering used on the display in each window. You can choose between viewing the text as a wireframe or from 3 different types of 3D shading.

6. Click the **Text Path** tab.
7. Click the **Text Position** drop-down list.

RESULT: The list will show two choices: Start Position and End Position.

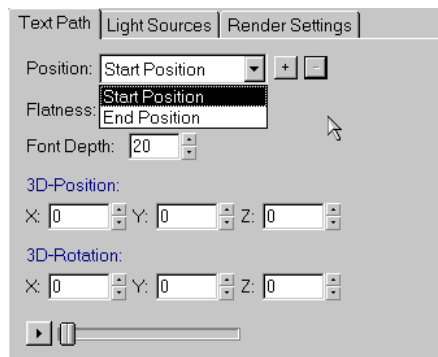

The **Text Position** drop-down list allows you to move the 3D text by specifying the x, y, and z coordinates it starts and stops on. It is also possible to add intermediary points to this list.

8. Click the **+** button next to the Text Position drop-down list.
9. Click the **Text Position** drop-down list.

RESULT: Intermediate #1 is added to the choices.

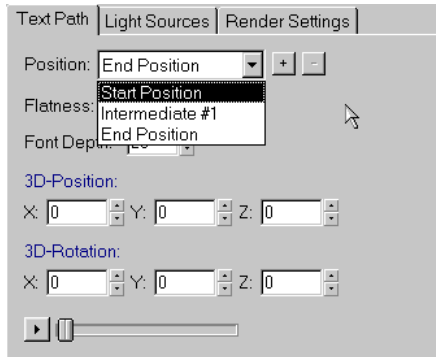

A text path is created by selecting any of the choices in the Text Position drop-down list and entering coordinates into the 3D-Position fields below it. By entering different locations in the start, end and intermediary points you give the text a series of points on a grid to follow.

- To create a path for the text to follow, enter graph points in each of the 3D Position fields for each choice in the Text Position drop-down list you have defined.



The position of the 3D text is determined by plotting three points along the X, Y, and Z axis of an invisible grid running through the screen. The X axis runs horizontally across the middle of the screen. The Y axis runs vertically across the middle of the screen. The Z axis controls the apparent depth or nearness of the text.

A position of (0,0,0) will place the 3D text right in the middle of the screen. Placing a positive number to the X field will move the text to the right of the X median. Placing a positive number in the Y field will move the text below the Y median. Placing a positive number in the Z field will make the text appear farther away from you. Placing a negative number in the fields will have the opposite effect: on the X axis, text will move to the left of the X median; on the Y axis, text will move above the Y median; and on the Z axis, text will appear to be closer to the viewer.

Here is an example of a 3D preview with X and Y axis values of 55, and a Z axis value of 44:

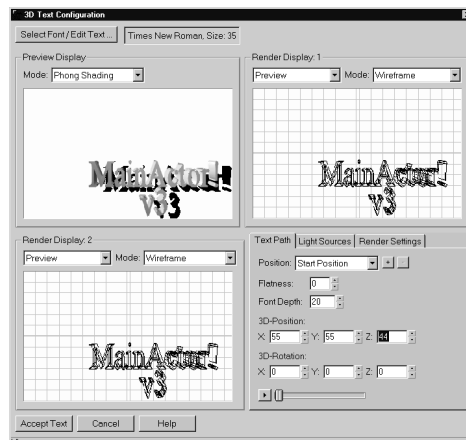

Here is an example of a 3D preview with X and Y axis values of -55, and a Z axis value of -44:

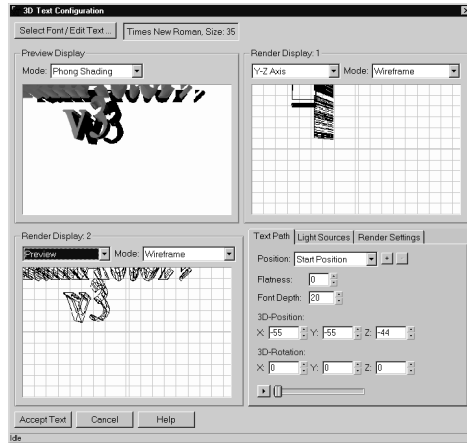

11. To rotate the 3D text, enter the X, Y, and Z degree values in the 3D Rotation fields for each item in the Text Position drop-down list you have defined.



While the entries in the 3D Position fields are mapped out as a grid, the entries in the 3D Rotation fields are mapped out as the degrees of a circle. This is because these values do not determine location, but rotation.

The X value determines how much the text is rotated forwards (i.e. The top of the text is rotated towards the screen). The Y value determines how much the text spins on its axis (like a globe). The Z value determines how much the text is rotated clockwise (like the hands on a clock).

Here is an example of text with X, Y, and Z rotation values of 40 degrees:

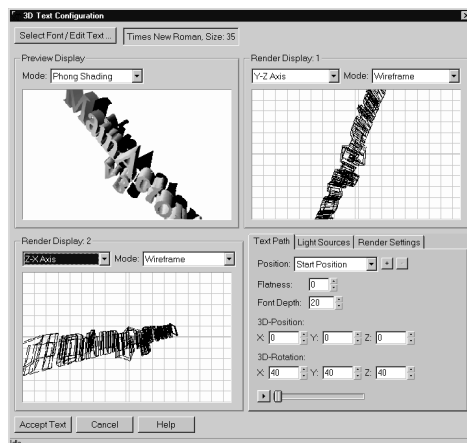

1. Click the **Light Sources** tab.

RESULT: The Light Sources settings are shown.

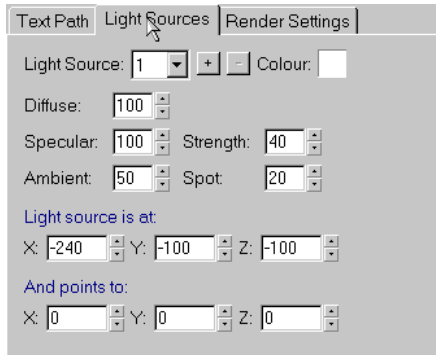

This area allows you to modify aspects of the light source. You can, for example, create more than one light source and place them in different areas on the grid. You can also change the strength, intensity, even the color of the light.

We will not be modifying anything here in this scenario.

2. Click the **Render Settings** tab.

RESULT: the Render Settings options are shown.

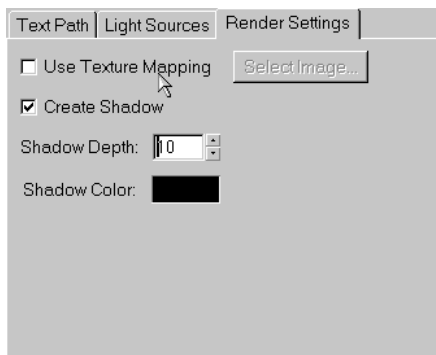

Render Settings lets you modify some of the different 3D aspects of the text. For example, Use Texture Mapping allows you to use a bitmap or other graphic as the texture of the text. The rest of the settings deal with the length and color of the shadow, or even if there is to be a shadow at all.

3. Click **Create Shadow** so it is unchecked.

RESULT: The Preview Window will remove the shadow (this will speed up the rendering process).

4. Click **Accept Text**.

RESULT: The 3D Text Configuration Window closes.

5. Move your mouse onto the V1 track.

RESULT: Your mouse pointer will change shape -- it will have a tiny "T" at the end of it. Also, a gray rectangle will follow it (the gray rectangle represents the text clip you have created).

Va 0:00:00.00		
Fx 0:00:00.00		
Vb 0:00:00.00		
V1 0:00:00.00		0:00:01.00
V2 0:00:00.00		
V3 0:00:00.00		

- The gray rectangle will have a time signature in the upper left hand corner. This time signature represents when in the project the animation will start. Drag the mouse along the V1 track until the time signature reads 0:00:00.00, then click on the left mouse button.

RESULT: The animation is inserted into the V1 track at 0:00:00.00.

Va 0:00:00.00		
Fx 0:00:00.00		
Vb 0:00:00.00		
V1 0:00:01.00	0:00:00.00	
V2 0:00:00.00		
V3 0:00:00.00		

- Move your mouse over to the right border of the text object.

RESULT: Your mouse will change shape to a double-headed arrow.

- Drag the border of the text object to the right.

RESULT: The text object will stretch, and a time indicator (which measures the time that the text object ends) will appear in the upper-right-hand corner of the gray rectangle.

Va 0:00:00.00		
Fx 0:00:00.00		
Vb 0:00:00.00		
V1 0:00:00.00	0:00:00.00	0:00:06.00
V2 0:00:00.00		
V3 0:00:00.00		

- When the time indicator reaches 0:00:06.00, release the left mouse button.

Va 0:00:00.00		
Fx 0:00:00.00		
Vb 0:00:00.00		
V1 0:00:06.00	0:00:00.00	0:00:06.00
V2 0:00:00.00		
V3 0:00:00.00		

RESULT: The duration of the text object will be lengthened to six seconds. The text object will be updated accordingly.

- Save your project.

- Click the **Show Quick Preview** button.

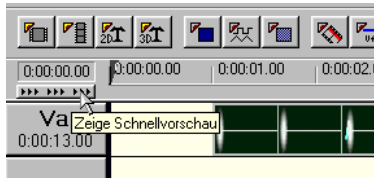

RESULT: a preview of the 3D text animation will be displayed in the Preview Window.



- Export your project the same way you did in the last two scenarios, but name your animation 3rdtry.
- Close MainActor Sequencer.

Adding Effects to a Video Track

Scenario: "There's a problem with this video," your boss tells you.

"First of all, there's this black splotch at the beginning of the film. It really doesn't do anything. Take it out."

"Second, lets make the beginning of the film a little bit more exciting. Put in some kind of exciting color that turns into another exciting color. Try using our corporate colors."

"Orange and Aqua?" You ask in disbelief.

Your boss nods. "Yeah, I think the stockholders will like that," he says.

"If they're color-blind," you mutter to yourself.

Your boss doesn't hear you. He's already left to play golf.

MainActor comes with many different effects that can be applied to animation tracks that will alter their default appearance. This scenario will show you how to apply special effects to your project.

- Open MainActor Sequencer.

RESULT: the Profile Window appears.

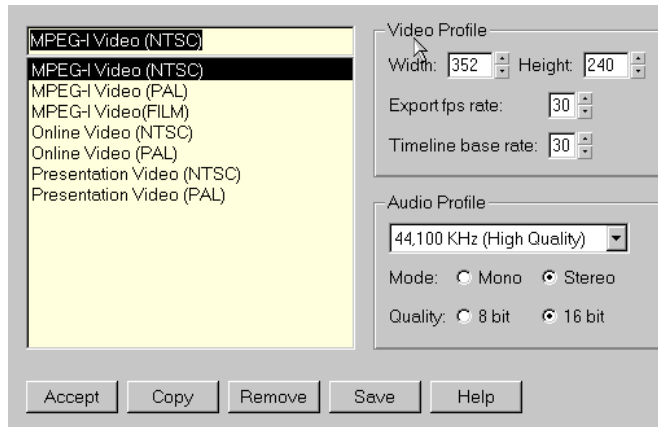

2. Click **Accept**.

RESULT: Profile Window closes.

3. From the Toolbar, click the **Insert Multimedia...** button.



RESULT: The Select file(s)... dialog appears.

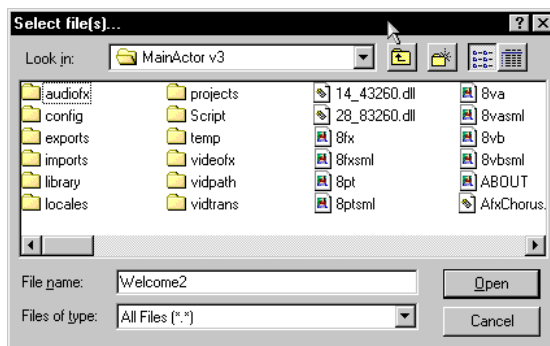

4. This tutorial was developed using the welcome1.avi file one the Windows 95 CD-ROM in the /Funstuff/Videos directory. If you have the Windows 95 CD-ROM, you can load it from there.

RESULT: The Select file(s)... dialog closes.

5. Move your mouse into the Va track.

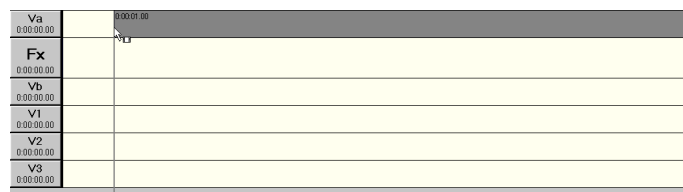

RESULT: Your mouse pointer will change shape -- it will have a tiny film clip at the end of it. Also, a large gray rectangle will follow it (the gray rectangle represents the film clip you have just opened.)

- The gray rectangle will have a time signature in the upper left hand corner. This time signature represents when in the project the animation will start. Drag the mouse along the Va track until the time signature reads 0:00:01.00, then click on the left mouse button.

RESULT: The animation is inserted into the Va track at 0:00:01.00.

- Double-click on the multimedia object in the Va track.

RESULT: the Object Settings Window opens.

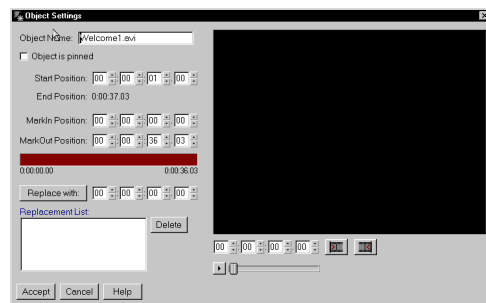

We will use the Object Settings Window to take out the black space that appears at the beginning of the film.

- Click on the slider control knob. Hit the right arrow button on your keyboard.

RESULT: the slider control knob moves to the right slightly, and the time counter advances slightly.



- Keep clicking the right arrow button until you see something other than a completely black screen.

RESULT: the time counter should read something close to 0:00:02.17.

- Click the **Markin** button.

RESULT: the Object Settings Info Area displays the Markin position at 0:00:02.17, and the Markin Indicator will show a blue space in the area that was not marked in.

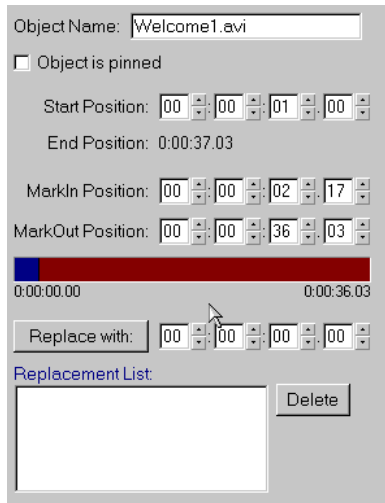

11. Click **Accept**.

RESULT: The dialog box closes. The track is updated so that only the portion of the film that was marked in is shown.

12. From the Toolbar, click on the **Insert Color** button.



RESULT: The Color Plate appears.



13. From the Color Modes region, click **Colorfade**.

14. Double-click on the **start color**.

RESULT: the Color Selection Dialog appears.

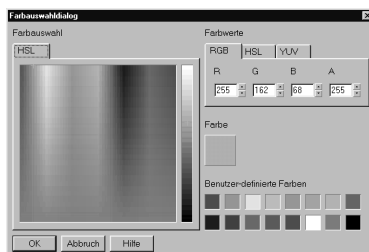

15. From the User Defined Colors region, click on the orange color then click **OK**.

RESULT: the Color Selection Dialog closes. The start color in the Color Plate is orange.

16. Double-click on the end color.

RESULT: the Color Selection Dialog appears.

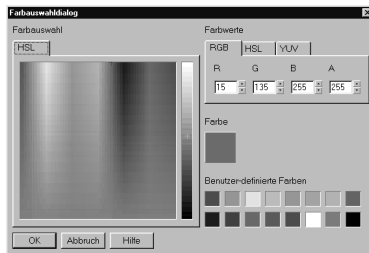

17. From the user Defined Colors region, click on the aqua color then click **OK**.

RESULT: the Color Selection Dialog closes. The end color in the Color Plate is aqua.

18. Move your mouse onto the V1 track.

RESULT: Your mouse pointer will change shape it will have a tiny film clip at the end of it. Also, a gray rectangle will follow it (the gray rectangle represents the color fade you have just created.)

19. The gray rectangle will have a time signature in the upper left hand corner. This time signature represents when in the project the animation will start. Drag the mouse along the V1 track until the time signature reads 0:00:00.00, then click on the left mouse button.

RESULT: The animation is inserted into the V1 track at 0:00:00.00.



20. Drag the right end of the color fade object on the V1 track until the time counter in the upper-right-hand corner reads 0:00:02.00.

21. Save your project in the /projects directory as colorfade, then return to the main screen.

- 22. Click the **Show Quick Preview** button.

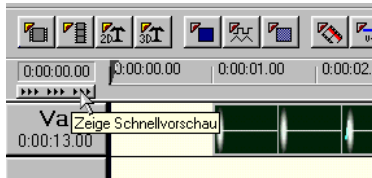

RESULT: when the Preview Window starts to play, the orange to aqua fade will be completely solid, and will obscure the video clip from view.

- 23. Move the orange to aqua color fade to the Vb track.

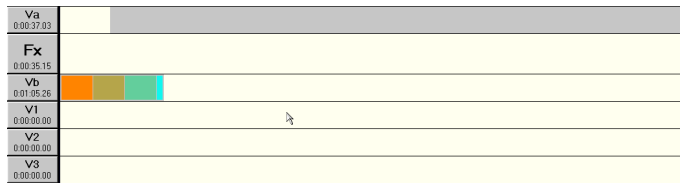

- 24. From the MainActor Browser Window, choose Additive Dissolve from the Dissolve section of the Video Transitions button.



The MainActor Browser Window is a general-purpose toolbox that can perform a variety of tasks. The MainActor Browser Toolbar will allow you to access seven different functions: Video Transitions, Video Effects, Video Paths, Audio Effects, Import/Export Modules, Browse Your Computer, and Library.

Objects in the MainActor Browser Window can be dragged and dropped into a project. Depending on the object you select, you will sometimes add it to the Fx track (if it is an effect that transitions from one track to the next,) and you will sometimes add it to an object itself (if, for example, it is an effect that will turn a video clip from a color video into a greyscale video).

- **Video Transitions** Video transitions enable you to create elaborate transitions from the Va track to the Vb track (or vice versa).

- **Video Effects** Video effects allow you to perform various manipulations on a clip such as warping, fading, solarizing and so on.

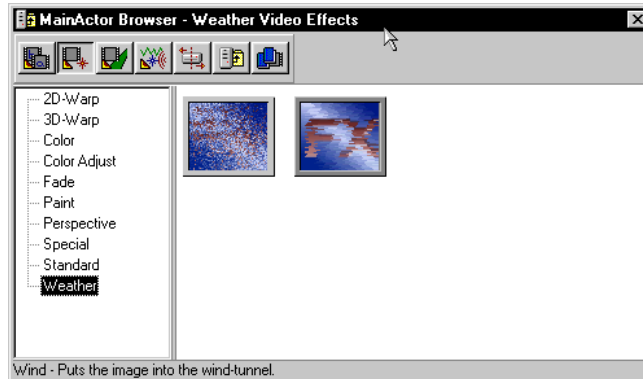

- **Video Paths** With video paths you can cause a clip to appear to follow a 2D or 3D path.

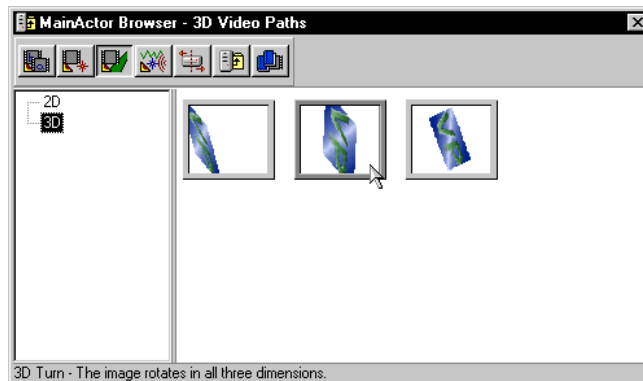

- **Audio Effects** The audio equivalent of Video Effects, you can take various options from this area and use them to modify any audio tracks you may have in your project.

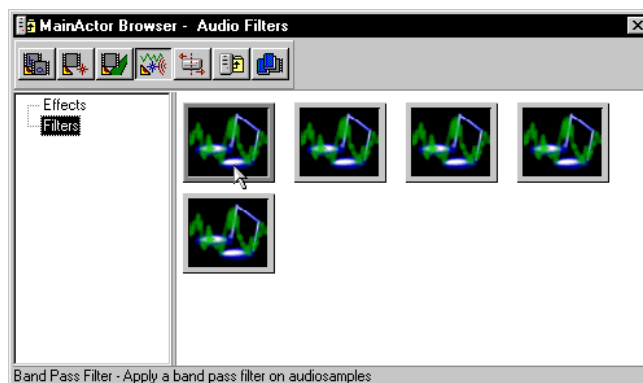

- **Import/Export Modules** This part of the MainActor Browser Window gives you access to the various import and export modules for MainActor Sequencer to

use. These modules control how multimedia files are loaded into MainActor Sequencer (importing) and saved to files from MainActor Sequencer (exporting).

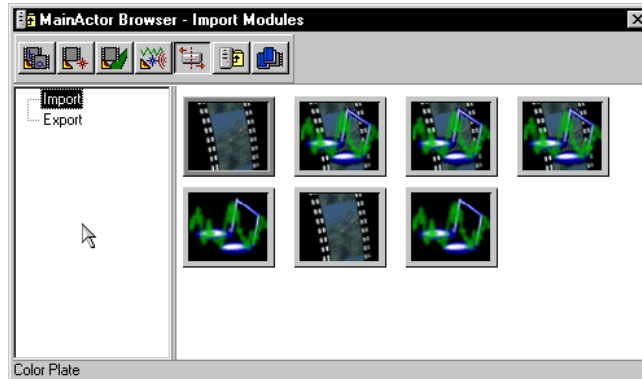

- **Browse Your Computer** This section of the MainActor Browse Window gives you access to the drives on your system as well as any network drives. This enables you to access files and drop them onto the MainActor Sequencer Timeline.

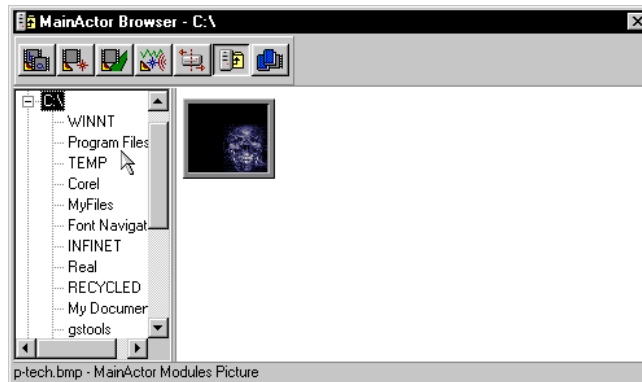

- **Library** An alternate means of storing media, this allows you to keep a repository of clip-art-like pictures for easy accessibility.



25. Drag the Additive Dissolve effect from the MainActor Browser into the 0:00:00.00 position on the Fx track.

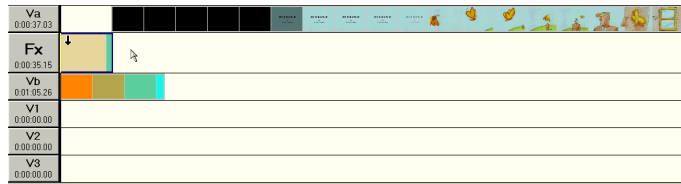

26. Stretch the right border of the Additive Dissolve object so that it ends at 0:00:02.00.



27. In the Additive Dissolve object on the Fx track, double-click on the arrow so that it points from the color fade object to the video clip object.

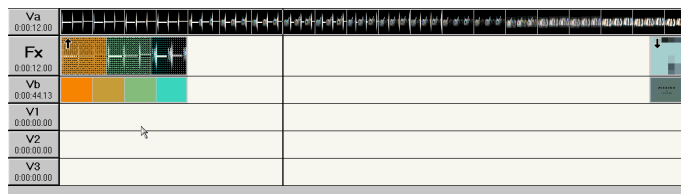

28. Save your project.
29. Click the **Show Quick Preview** button.

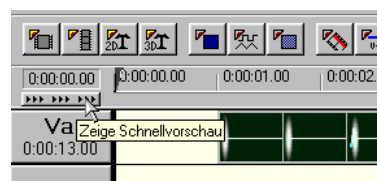

Result: the Preview Window will show that the orange to aqua color fade dissolves into the video clip.

30. Export your project the same way you did in the other scenarios, but name your animation colorfade.
31. Close MainActor Sequencer.

MainActor Video Capture

This chapter gives an introduction to MainActor Video Capture, the component of MainActor used with your capture hardware to input data from a video signal.

Introduction to MainActor Video Capture

Ordinary VCRs and cameras work with analog signals. To operate video with a computer, the signal has to be digitized, analogous to getting sound into a computer. This is done with an application for controlling the video converting chips (on either the graphics card or an extra video or TV card), and for storing the data from the video conversion in a video file on the computer's hard disk.

Files

Video for Windows' default format for storing digital video is AVI files. The AVI files can contain sound, too, so the sound and the pictures are in one file which simplifies the handling. Single pictures can be stored in individual files (.DIB, device independent bitmap files), also several single pictures can be stored in sequence in an AVI file.

Frames

The individual pictures in a video are called "frames", which comes from the pictures being "framed" with controlling signals in your TV. The flows of picture or sound data are named "streams". For files with two streams of data (video and audio), the two streams can optionally be coupled ("synchronized") to make the pictures and the sound remain synchronized. Without synchronization, the video and audio streams can drift apart during playback of the AVI file. For the video stream, the amount of data per time is called the "frame rate" and is measured in "frames per second." However, for recording very slowly, another way to define this measurement is the time interval between two frames: "seconds per frame".

Video Format

Video signals can have several formats, the most well known are NTSC and PAL. The resolution for capturing can be selected (e.g. 640x480 or 320x200). This resolution is the capture chip's output after digitizing the input signal's original resolution.

Audio Format

The audio signal is one or two wave signals (Stereo or Mono), the "height" of the wave is sampled with a "sampling frequency". The resolution of the sampling is given as the

“sample size” e.g. a standard audio CD uses two audio data streams for Stereo, a sampling frequency of 44.1 kHz and a resolution of 16 bits.

The Video Capture Application

The Lay of the Land

The window of the capture application contains the video picture, a toolbar, and a menu. In the menu all the commands for controlling the video capturing are contained. In the “File” menu you can call up the file name dialogs for frame capture and video capture. The “Source” menu lets you select an input device for the video capture. The “Capture” menu has the items for starting the capturing. With the “Settings” menu you can control the video and audio formats and other properties.

The toolbar contains the most-used items of the menu, and is divided into four partitions. From left to right, these are: frame capture, video capture, view control and capture options (the frame rate, and audio capture enabling)

How to view the input signal

Video for Windows supports two modes of viewing the input signal: “Overlay” is the original signal, as detected by the video chips, “Preview” is the signal converted to the frame rate selected in the toolbar’s rightmost partition. To select a frame rate, use the button with the stopwatch to select between “frames per second” and “seconds per frame”, and then set the numeric entry left of that button to the desired value.

How to capture a single frame

The leftmost part of the toolbar contains the buttons for Frame Capture. With the left button the file name is selected. Then the current frame can be captured by clicking on the right button (camera to file, with a frame in the upper right).

How to capture a frame sequence

In the second partition, there are four buttons. With the left button, the file name for capturing the frames is entered. With the third button (camera to frame, with the video symbol in the upper right), the capturing of the frames sequence is started and ended. After starting the sequence capture mode, the fourth button (frame to file with a video symbol in the upper right) is then used to capture the current frame to the AVI file.

This manually selects frames for saving sequentially in the video file.

How to capture video

Like capturing a frame sequence, the buttons of the second toolbar are employed to capture video. After setting the file name with the first button, the second button (camera to file, with the video symbol in the upper right) starts capturing the video signal continuously. The capture is ended with pressing the ESC key.

This is an automatic frame capture, which uses the frame rate from the tool bar as does the "Preview".

Settings

There are six dialogs to manipulate the settings of the capture application: "Audio-Format", "Video-Format", "Video-Source", "Video-Display", "Video-Compression", "Other Video-Settings". These dialogs are dependent on the device driver which is controlling the capture device you selected in the menu "Source".

Video Capture Tutorial

First, you should check that your equipment is connected and switched on. The video input can be easily monitored by using the "Overlay" function, which is started by pressing the toolbar button with the eye and the camera. (Or, if the overlay function is unavailable, use the "Preview" button beside the "Overlay" button). If there is no picture, the next step would be to select the video input device (the computer's hardware that receives the video signal), by opening the "Source" menu, and clicking on the menu entry for the desired menu entry.

If the picture is warbled, or there is still no picture, there might be a mix-up between NTSC and PAL for the video signal and the video input device. That is, the signal might be PAL when the input device is trying to detect NTSC or vice versa. The result is that the input device can't synchronize with the video signal. This can be remedied by using the "Settings" menu and selecting "Video Source" to open the device's source dialog. In the source dialog, you can set the video signal's format to PAL, NTSC or SECAM, select the connector of the device which the video input is connected to, and correct the color settings of the signal.

The next step should be selecting the desired resolution of the picture. This is done with the "Video Format" dialog in the "Settings" menu. This dialog lets you select the resolution of the digitized video data (e.g. 640x480 pixels), the color depth (e.g. RGB 16-bit = 65536 colors), and possibly have the signal mirrored horizontally.

Now that the signal is configured, the next thing is the frame rate (how many pictures you record per second). You enter the frame rate in the numeric entry in the toolbar's rightmost partition, e.g. if you want to record ten frames (=video pictures) each second, you enter 10 here. Right of the numeric entry field is a button with a movie and a stop-

watch, where an arrow points from the movie to the stopwatch to indicate “frames per second” or from the stopwatch to the movie for “seconds per frame”. For ten frames each second, you select the “frames per second” setting of this button then set the numeric value to 10. “Seconds per frame” is the inverse measuring scale: the time between two frames is entered in the numeric field; lets say you want one frame every five seconds: you would push the button to indicate “seconds per frame” then enter 5 in the numeric field.

At this point everything is set except for the name of the file which will hold the captured data. The second toolbar partition holds four buttons. The leftmost button (with the document “ab” and the movie symbol) starts a dialog that lets you select or enter the file name.

The second button (with the movie symbol, where an arrow points from a camera to a document symbol) starts the capturing. Below the video view, in the status line of the capture window, the device displays how many frames have been captured (dropped frames are pictures that were lost during the process of capturing and are obviously not saved in the capture file).

Capturing is ended by pressing the ESC key. The application shows a total in the status line, and the file is saved to disk (the data writing might lag somewhat with high frame rates).

Video Capture Tips

Now that you have done a capture, here's some more detail on parameters to set up for capturing video.

The most important thing to consider is compression, since a single frame of 640x480 pixels with 16-bit colors is already 614 Kilobytes, adding CD quality sound to a video of 30 fps (frames per second) gives you a total of 18.6 MBytes each second! For a disk space of 1 Gigabyte, this space is used up after about 54 seconds!

So, to save disk space and disk writing time (not every hard disk can write 18.6MB/s; some top models for PC's reach 5-8MB/s; the average hard drive writes around 2-3MB/s), you must select a compression.

Video compression works differently than other compressions you may be familiar with such as Zip. Compression can be either *lossless* or *lossy*. The Zip compression scheme is a lossless compression scheme because uncompressing compressed data results in exactly the original data. In other words, lossless compression is fully reversible. This reversibility is necessary if you want to read a document that was ZIPped on another computer. Video (and audio) compressions can't be efficiently compressed with lossless schemes because they are simply too inefficient, making the achievable compression on video (and audio) too low. So video (audio) compression is done with lossy compression schemes which exploit limitations of the human eye (and ear) to reduce the amount of data that has to be stored without the eye (or ear) noticing much of a difference. Thus,

uncompressing data that were compressed with a lossy scheme does not result in exactly the original data. Some of the information is thrown away but you can tune how much information is removed via the quality setting of the compression scheme.

MainActor Video Capture can also use video compression when capturing video input. Normally, full (=uncompressed) frames are saved in the AVI file, but with "Video Compression" from the "Settings" menu, you can select one of the installed codecs (Compressor/DECompressor modules). Besides the "Microsoft Video" and "Index" codecs, you may also use "MCMJPG", the Motion-JPEG codec from MainConcept.

The "Video Compression" dialog consists of a select box for selecting the codec, a slide for changing the quality/reduction percentage, and allows setting the key frames. Some video compressions start with a key frame derived from a full frame, and compress only the differences of the next, "incremental" frames from there. To reduce computing load, you can use a greater distance between key frames and thus more incremental frames. For better reproduction, especially when the video pictures are rapidly changing, you can use a smaller number of incremental frames between the key frames.

The quality setting gives a crudely calculated percentage of quality against uncompressed frames. A higher quality setting means better quality but lower data compression. A lower setting means more reduction and thus lower quality. A PC with a Pentium II at 333MHz, using our MJPG codec at 50% quality setting, captures and compresses a 640x480, 16-bit video at 15fps (~9MB/s) of 38 seconds to a file of 37MB file size, about 1MB/s, that's a compression rate of 1:9 which allows for using standard IDE hard disks. Your results might vary of course.

Another important consideration is capturing both video and audio. That means, besides having a video signal connected from your VCR or camera to your computer's video input hardware, you must connect an audio signal from the VCR, camera or a microphone. You enable mixed video and audio capturing either with the rightmost button in the toolbar (with the movie and loudspeaker symbols), or with the "Other Video Settings" dialog from the "Settings" menu. In the "Other Video Settings" dialog, you can also enable synchronizing the video and audio data in the capture file. During playback, the video and the audio data streams can drift apart, and synchronizing stops this drift, but might also reduce sound or picture quality during playback.

Besides enabling sound recording with the audio capture button, you can also manipulate the capturing of audio data with "Audio Format" of the "Settings" menu. Analog audio is a wave signal, to digitize these waves, the audio hardware (mostly: your sound card) takes a "sample" and compares it to a reference, this comparison is measured with a resolution - the "sample size" of either 8-bit or 16-bit. The rate with which the computer takes the samples is the "sampling rate" (e.g. 44.1 kHz for CD quality). Also you must select between Mono and Stereo sampling (one or two audio channels). So, to record sound with CD quality, you'd use Stereo, 44.1 kHz sampling with 16-bit; FM radio-like sound is about 22.05 kHz, 16-bit Stereo (half the data of CD quality),

and telephone “quality” you get with 8 kHz -11.025 kHz, 8-bit Mono (one sixteenth of the data CD quality generates).

Appendix A

Supported File Formats

This section lists all the graphic, animation and multimedia file formats supported by MainActor. Individual discrepancies and special information on each file format are also listed here.

These modules are used by MainActor VE. MainActor Sequencer also uses these modules through the MainActor Import/Export modules but also supports the Video for Windows, DirectShow and RealVideo APIs. MainActor Sequencer also has an import module (Tracker) that supports FastTracker 2, ScreamTracker 3, MultiTracker, Oktalyzer, TakeTaker Pro, Pro Tracker, and Impulse. The various modules can be selected from the program toolbar. The module used by the "Insert Multimedia..." toolbar button can be changed in the program preferences and defaults to the MainActor module.

The supported files in MainActor are listed by Module type (AVI, GIF, etc.). Each entry lists the Codec choices that each Module type supports, and the Saver Modules information also lists what specific properties can be set in the Module Options window.

Loader Modules

These File Formats can be loaded into and played by MainActor.

8SVX

Type: Sound

Codecs Supported:

- 8-bit: uncompressed
- 8-bit Fibonacci-delta encoding
- 8-bit Exponential-delta encoding

AU

Type: Sound

Codecs Supported:

- A-Law Encoding
- U-Law Encoding
- 8-bit: Linear
- 16-bit Linear
- 32-bit Linear

AVI

Type: Animation (plus Sound)

Codecs Supported:

- 16 Colors: Uncompressed
- 256 Colors: Microsoft RLE
- 256 Colors: Microsoft Video 1
- 256 Colors: Uncompressed
- Thousands of Colors: Microsoft Video 1
- Millions of Colors: Cinepak(TM) Radius
- Millions of Colors: Intel Indeo(TM) R2.1
- Millions of Colors: Intel Indeo(TM) R3.1
- Millions of Colors: Intel Indeo(TM) R3.2
- Millions of Colors: Intel Indeo(TM) Raw
- Millions of Colors: Motion JPEG
- Millions of Colors: Ultimotion(TM) IBM
- Millions of Colors: Uncompressed

BMP

Type: Picture

Codecs Supported:

- 2 Colors: Uncompressed
- 16 Colors: Uncompressed
- 16 Colors: RunLength Encoded
- 256 Colors: Uncompressed
- 256 Colors: RunLength Encoded
- Millions of Colors: Uncompressed
- Millions of Colors: RunLength Encoded

DL

Type: Animation

Codecs Supported:

- 256 Colors: Type 1
- 256 Colors: Type 2

FLC

Type: Animation

Codecs Supported:

- 256 Colors: ByteRun
- 256 Colors: Bye LineCoding
- 256 Colors: Clear Screen
- 256 Colors: Uncompressed
- 256 Colors: Word LineCoding

FLI

Type: Animation

Codecs Supported:

- 256 Colors: ByteRun
- 256 Colors: Byte LineCoding
- 256 Colors: Clear Screen
- 256 Colors: Uncompressed

GIF

Type: Picture

Codecs Supported:

- 256 Colors: GIF-LZW

GIF - Anim

- Type: Animation
- Codecs Supported:
- 256 Colors: GIF-LZW

IFF

Type: Picture

Codecs Supported:

- 256 Colors: ByteRun
- Millions of Colors: ByteRun

IFF - Anim3

Type: Animation

Codecs Supported:

- 256 Colors: ByteRun
- 256 Colors: Delta3

IFF - Anim5

Type: Animation

Codecs Supported:

- 256 Colors: ByteRun
- 256 Colors: Delta5

IFF - Anim7

Type: Animation

Codecs Supported:

- 256 Colors: ByteRun
- 256 Colors: Delta7_16
- 256 Colors: Delta7_32

IFF - Anim8

Type: Animation

Codecs Supported:

- 256 Colors: ByteRun
- 256 Colors: Delta8_16
- 256 Colors: Delta8_32

IFF - AnimJ

Type: Animation

Codecs Supported:

- 256 Colors: ByteRun
- 256 Colors: DeltaJ

JPEG

Type: Picture

Codecs Supported:

- Millions of Colors: JPEG

MPEG

Type: Animation

Codecs Supported:

- Millions of Colors: MPEG-1
- Millions of Colors: MPEG-2

MPEG-Audio

Type: Sound

Codecs Supported:

- 16 Bit: Audio Layer I
- 16 Bit: Audio Layer II
- 16 Bit: Audio Layer III

PCX

Type: Picture

Codecs Supported:

- 16 Colors: RunLength Encoded
- 256 Colors: RunLength Encoded
- Millions of Colors: RunLength Encoded

PNG

Type: Picture

Codecs Supported:

- 2 Colors: Compressed
- 16 Colors: Compressed
- 256 Colors: Compressed
- Millions of Colors: Compressed

PPM,PGM,PBM

Type: Picture

Codecs Supported:

- Millions of Colors: Uncompressed, P6/P3, *.PPM
- 256 Graylevels: Uncompressed, P5/P2, *.PGM
- Black & White, Uncompressed, P4/P1, *.PBM

QuickTime

Type: Animation (plus Sound)

Codecs Supported:

- 256 Colors: Apple Animation
- 256 Colors: Apple Graphics
- 256 Colors: Uncompressed
- Thousands of Colors: Apple Animation
- Thousands of Colors: Apple Video
- Thousands of Colors: Uncompressed
- Millions of Colors: Apple Animation
- Millions of Colors: Cinepak(TM) Radius
- Millions of Colors: Intel Indeo(TM) R2.1
- Millions of Colors: Intel Indeo(TM) R3.1
- Millions of Colors: Intel Indeo(TM) R3.2
- Millions of Colors: Intel Indeo(TM) Raw
- Millions of Colors: Motion JPEG
- Millions of Colors: Uncompressed

TGA

Type: Picture

Codecs Supported:

- 256 Colors: RunLength Encoded
- 256 Colors: Uncompressed
- Thousands of Colors: RunLength Encoded
- Thousands of Colors: Uncompressed
- Millions of Colors: RunLength Encoded
- Millions of Colors: Uncompressed

WAV

Type: Sound

Codecs Supported:

- 8/16 Bit: Pulse Code Modulation

Saver Formats

MainActor VE can save projects into the following file formats.

AVI

Type: Animation

Codecs Supported:

- 256 Colors: Microsoft RLE
- 256 Colors: Uncompressed
- Millions of Colors: Intel Indeo(TM) R3.1
- Millions of Colors: Motion JPEG
- Millions of Colors: Ultimotion(TM) IBM
- Millions of Colors: Uncompressed

Module Options:

- Codec Quality (1-100), Default -1
- Codec Keyframe Rate (1-1000), Default -1
- Disable Audio (save video only) ON/OFF

AVI uses global timecodes. If you encounter an AVI animation which MainActor VE does not play correctly (or uses a codec unknown by MainActor VE) please contact MainConcept.

BMP

Type: Picture

Codecs Supported:

- 256 Colors: Uncompressed
- 256 Colors: RunLength Encoded
- Millions of Colors: Uncompressed
- Millions of Colors: RunLength Encoded

Module Options:

- Use old OS/2 1.x/Windows 2.x header if possible OR
- Use Windows 3.0 header if possible (Default) OR
- Always use OS/2 2.0 header

FLC

Type: Animation

Codecs Supported:

- 256 Colors: Word LineCoding

FLC animations are limited to 256 colors and use global timecodes.

FLI

Type: Animation

Codecs Supported:

- 256 Colors: Byte LineCoding

FLI only supports 320x200 images. FLI animations are limited to 256 colors and use global timecodes.

GIF

Type: Picture

Codecs Supported:

- 256 Colors: GIF-LZW

Module Options:

- Interlace ON/OFF
- Color Index Values (0-255), Background Index, Default 0
- Color Index Values (0-255), Transparent Index, Default 0

GIF supports 256 colors only. The LZW decoding/encoding is officially licensed from Uni-Sys.

GIF - Anim

Type: Animation

Codecs Supported:

- 256 Colors: GIF-LZW

Module Options:

- Interlace ON/OFF
- Color Index Values (0-255), Background Index, Default 0
- Color Index Values (0-255), Transparent Index, Default 0
- Netscape Loop, Default 10 ON/OFF

Animated GIFs support local timecodes, so it is possible to convert AVI or Quicktime animations to GIF-Anim without loss of timing information. GIF supports 256 colors only. The LZW decoding/encoding is officially licensed from UniSys.

JPEG

Type: Picture

Codecs Supported:

- Millions of Colors: JPEG

Module Options:

- Compression Quality, Default 75

MacPICT

Type: Picture

Codecs Supported:

- 256 Colors: RunLength Encoded
- Thousands of Colors: RunLength Encoded
- Millions of Colors: RunLength Encoded

MPEG - Audio

Type: Sound

Codecs Supported:

- 16 Bit: MPEG-Audio Layer I

Module Options:

- Audio Bitrate, Default 128 kb/s
- Audio Sampling Rate, Default 41.100
- Audio Checksums (error protection) ON/OFF

The Audio file is split into 1 seconds parts when loaded into MainActor VE. This makes it easier to access specific parts of the audio file.

MPEG - I

Type: Animation

Codecs Supported:

- Millions of Colors: MPEG-I NTSC (30 fps)
- Millions of Colors: MPEG-I PAL (25 fps)
- Millions of Colors: MPEG-I FILM (24 fps)

Module Options:

- Video Bitrate, Default 1151000
- Ignore MPEG-I Video Limit ON/OFF
- Audio Bitrate, Default 128 kb/s
- Audio Sampling Rate, Default 41.100
- Audio Checksums (error protection) ON/OFF
- Ignore Audio (save audio only) ON/OFF

This is the best option for MPEG-I encoding with MainActor VE.

MPEG - I/II

Type: Animation

Codecs Supported:

- Millions of Colors: MPEG-I NTSC (30 fps)
- Millions of Colors: MPEG-I PAL (25 fps)
- Millions of Colors: MPEG-II NTSC (30 fps)
- Millions of Colors: MPEG-II PAL (25 fps)

Module Options:

- MPEG-I Video Bitrate, Default 1151000
- MPEG-II Video Bitrate, Default 5000000
- Interlace ON/OFF
- Top Field, Default 0
- Audio Bitrate, Default 128 kb/s
- Audio Sampling Rate, Default 41.100 kb/s
- Audio Checksums (error protection) ON/OFF

PNG

Type: Picture

Codecs Supported:

- 256 Colors: Compressed
- Millions of Colors: Compressed

Module Options:

- Adam7-Interlaced ON/OFF

PPM,PGM,PB

Type: Picture

Codecs Supported:

- P6 - Millions of Colors: Raw & Uncompressed, *.PPM
- P5 - 256 Graylevels: Raw & Uncompressed, *.PGM
- P4 - Black & White: Raw & Uncompressed, *.PBM
- P3 - Millions of Colors: ASCII & Uncompressed, *.PPM
- P2 - 256 Graylevels: ASCII & Uncompressed, *.PGM
- P1 - Black & White: ASCII & Uncompressed, *.PBM

QuickTime

Type: Animation

Codecs Supported:

- Millions of Colors: Intel Indeo(TM) R3.1
- Millions of Colors: Motion JPEG

Module Options:

- Codec Quality (1-100), Default -1
- Codec Keyframe Rate (1-1000), Default -1
- Disable Audio (save video only) ON/OFF

Quicktime supports local timecodes. If you encounter a Quicktime animation which MainActor VE does not play correctly (or uses a codec unknown by MainActor VE) please inform MainConcept.

TGA

Type: Picture

Codecs Supported:

- 256 Colors: RunLength Encoded
- 256 Colors: Uncompressed
- Thousands of Colors: RunLength Encoded
- Thousands of Colors: Uncompressed
- Millions of Colors: RunLength Encoded
- Millions of Colors: Uncompressed

Video Data

Type: Picture

Codecs Supported:

- Binary: Video Frame Data

This format splits the compressed video data from animations. It is very useful to save standalone image data from animation formats. For example, motion JPEG AVIs and Quicktime animations contain standalone JPEG image data for each frame. using this aver module you can save them into single files without having to decompress and then compress them again.

WAV

Type: Sound

Codecs Supported:

- 8/16 Bit: Pulse Code Modulation

Appendix B

MainActor VE Command Reference

This section explains how to use all of the MainActor VE tools and commands.

Instead of being listed in alphabetical order, the commands are organized by how they appear on the MainActor VE screen. For example, the Open, Close, Save As, Close All and Exit commands are accessed through the File menu, so they are found in the "File" listing under Menu List Commands. The Open, Close, and Save As commands are also buttons on the toolbar, so they are mentioned under Toolbar Commands as well.

Menu List Commands

All of the following commands are accessible from the MainActor VE menu:

File

- **Open... [Alt+O].**

This command will cause a standard file dialog box to open, allowing you to load an animation into MainActor VE as a project. It is possible to load more than one file into MainActor VE simultaneously.

- **Close [Alt+S]**

This command will close the project without saving any changes made while it was open.

- **Save As... [Alt+A]**

When you're ready to save a project, the Save As... command will open the Save Window. This dialog box allows you to determine what file format the project will use, to modify some general characteristics of the animation, and of course actually save the file.

- **Close All [Alt+L]**

This command is similar to the Close command above, but it will close every project loaded into the project area at once, not just the one that is currently active.

- **Exit [Alt+E]**

This command will close the MainActor VE window and end the program. This command will not prompt you for verification, and if you have loaded any projects into MainActor VE they will be closed without being saved.

Edit

- **Copy to Clipboard**

Copies the selected information into the clipboard. If you select a frame and copy it to the clipboard, you can paste it anywhere, in any application.

■ **Select**

While you can use your mouse to select an individual or a series of frames, (and use can use your mouse plus the Ctrl button to select multiple frames out of series), you can also select project frames via the MainActor VE window.

All {Alt++}

This command selects (highlights) every frame in your project.

Range...

This command will open the Select Range dialog box, allowing you to specify a series of frames to be highlighted. The parts of this dialog box are as follows:

From

This field specifies what frame will be the first frame to be selected. It defaults to the first frame in the project.

To

This field specifies what frame will be the last frame to be selected. It defaults to the last frame in the project.

Accept

Clicking this button will select the frame specified in the "From" field, the frame in the "To" field, and every frame in between.

Cancel

Clicking this button will close the Select Range dialog box without selecting any frames.

Help

Opens the Help dialog.

Compression...

After you have selected a series of frames, the Select Compression dialog box lets you select the frames in the Frame List which have a specific compression method.

Compression Format field

This area will list what compression formats are available for use on the selected frames. Selecting the compression format and clicking on the "accept" button will apply that format to the selected frames.

If there is more than one possible format to choose from, only one can be selected.

Accept

Clicking this button will apply the chosen file compression format to the selected frames.

Cancel

Clicking this button will close the Select Compression dialog box without selecting any frames.

Help

Opens the Help dialog.

■ Deselect

When a series of frames are selected, these commands can deselect all of them, some of them, or decompress them if they are compressed.

All [Alt+-]

This command deselects every frame in your project.

Range...

This command will open the Deselect Range dialog box, allowing you to specify a series of frames to be deselected.

From

This field specifies what frame will be the first frame to be deselected. It defaults to the first frame in the project.

To

This field specifies what frame will be the last frame to be deselected. It defaults to the last frame in the project.

Accept

Clicking this button will deselect the frame specified in the "From" field, the frame in the "To" field, and every frame in between.

Cancel

Clicking this button will close the Deselect Range dialog box without deselecting any frames.

Help

Opens the Help dialog

Compression...

After you have selected a series of frames that use a graphics format that utilizes compression, the Deselect Compression dialog box lets you remove the compression from those graphics.

Invert [Alt+V]

This command will switch frames that are selected with frames that are not selected: the frames that are selected will become unselected, and the frames that are unselected will become selected.

Capture Video...

Opens the Video Capture window. See Chapter 7 for information on video capture.

Project**Project Info... [Alt+I]**

This command opens the Project Info window, which displays basic information about your MainActor VE project.

Name

The name of the project file.

Format

The animation or graphic format of your project file (i.e., MPEG or JPEG).

Width

The width (in pixels) of the frames in your project.

Height

The height (in pixels) of the frames in your project.

Frames

The number of frames in your project.

Loop Frames

The number of times you have set the frames in your project to loop.

Average Image Size

The average size, in bytes of each frame in your project.

Average Sound Size

The average size, in bytes, of the sound file per frame.

Sample mode

The way the sound was recorded (mono or stereo).

Bits Per Sample

The number of bits per sample, typically 8 or 16 bits. The sound quality improves with the number of bits. This field is empty when no sound is associated with the project.

Samples Per Second

The samples which are played per second (in Khz). More samples are equivalent with better sound quality. This field is empty when no sound is associated with the project.

Total Project Size

The size, in bytes, of the project.

Color Space Spec

The color space format of the project.

Global Timecode... {Alt+G}

This command allows you to change the timecode an animation. Changing the timecode alters how long each frame is displayed in an animation before the next frame takes its place. Timecodes are set in milliseconds -- a 20 frame animation with a global timecode setting of "4" would take a total of 80 milliseconds to run.

Enter Timecode field

The number entered into this field will define the local timecode in milliseconds.

Accept

Clicking this button will apply the local timecode as defined in the Enter Timecode field.

Cancel

Clicking this button will close the Local Timecode window without changing the default timecode.

Help

Opens the Help dialog.

Cache Data [Alt+C]

This command loads the entire project into RAM, which results in better access and playback times. If the menu item is checked, the data is cached in memory. If not, the data will be loaded directly from disk (this is the default for all projects.)

Not all loader modules support caching. If a loader module does not support caching, the menu item is disabled. This is the case for most of the picture loader modules.

Play Project... [Alt+P]

This command loads the entire project into MainView.

Remove Project... [Alt+R]

Closes the project without saving any changes you may have made while it was open.

Frames**Save Frames... [Ctrl+F]**

This command opens the Save Window with the Selected Frames Only radio button pre-selected.

Local Timecodes... [Ctrl+L]

This command allows you to change the timecode individual frames within an animation without changing the timecode of every frame. Changing the timecode alters how long each frame is displayed in an animation before the next frame takes its place. Timecodes are set in milliseconds -- a 20 frame animation with a global timecode setting of "4" and four local timecodes of "10" would take a total of would take a total of 104 milliseconds to run.

Enter Timecode field

The number entered into this field will define the local timecode in milliseconds.

Accept

Clicking this button will apply the local timecode as defined in the Enter Timecode field.

Cancel

Clicking this button will close the Local Timecode window without applying any changes.

Help

Opens the Help dialog.

Show Frames... [Ctrl+S]

This command loads any frames you have selected sequentially into MainView. If you have selected more than one frame to load, you may play them sequentially as an animation.

Show Palette... [Ctrl+P]

This command opens the Palette Editor. The Palette Editor is used when you are working with 256 (8-bit) images and you want to optimize what colors are available.

You can open saved palettes with the Palette Editor and use them instead of the default one.

The Color Grid is a grid of 256 colors (numbered 0-255) are visible at the top of the window. These are the colors and shades of color that the palette is currently using with the animation.

Clicking on one of the squares in the color grid will cause that square's number to appear in the Selected Color field. Any square listed in the Selected Color field is active, and any changes made in any of the other fields will affect this block.

It is possible to exchange color information with the selected color and another block on the color grid by entering the other block's number in the Swap Color Index field and pressing the "Swap" button.

The Red, Green, and Blue fields list the amount of that color (from 0-255) present in the selected color on the color grid. You can change this field by selecting the current value, deleting it, and entering another value in its place.

Sort Frames

These tools modify in what order the frames appear in the Frame List area. This tool can only be used when you are displaying a series of pictures, not animations.

by Name (Normal)

When this option is selected, the frames will be sorted by their names. This is a case-insensitive process (whether or not the names use capital letters will have no effect on the sort).

by Name (Inverse)

When this option is selected, the frames will be sorted by their names inversely. This is a case-insensitive process (whether or not the names use capital letters will have no effect on the sort).

by Size

When this option is selected, the frames will be sorted by their file size, with the smaller pictures being placed at the top of the frame list, and the larger pictures being placed at the bottom of the list.

Remove Frames [Ctrl+R]

This command removes a frame from the Frame List.

Settings

■ Show Timecodes As

MainActor VE recognizes three different time systems that you can use when working on your project.

/1000 Sec

This time code setting displays the timecode for every frame in terms of milliseconds.

HH:MM:SS:MS

This time code setting displays the timecode of the frames relative to the beginning of the project in hours, minutes, seconds and milliseconds. The head of the timecode column will display the time of the entire project.

HH:MM:SS.FF

This time code setting is based on a frames per second basis.

MainActor will determine the frames per second rate of the entire project, then display the timecodes based on this fps rate in hours minutes, seconds, and frame offset. The frame offset is between 0 (the first frame that will appear in the second) and the frames per second minus 1 (the last frame appearing in that second).

For example, if you are displaying an animation at 5 frames per second, the first 5 frames would display the following timecodes:

00:00:01.0 (the first frame appearing in the first second)

00:00:01.1

00:00:01.2

00:00:01.3

00:00:01.4 (the last frame appearing in the first second)

The head of the timecode column will display the length of the entire project.

■ Playback

These tools allow you to change the global playback settings of the display window (MainView).

Autostart

If this item is enabled, the project will play immediately after being loaded. Otherwise it will wait for a play command from the toolbar or the menu.

Titlebar

Specifies what will be displayed in the Titlebar when the project is loaded.

Project Title

The project's title will be displayed in the Titlebar.

Frame Counter

When playing, the Titlebar will display the current frame number being shown (when loaded, the Titlebar will display a "1" unless only some of the frames in a project were loaded into MainView).

Frames per Second

The Titlebar will display how many frames are viewed per second.

Repeats

Specifies how many times projects without sound will be repeated when they are played. Projects with sound will only be repeated once.

Repeats:1

This is the default setting, and selecting this command will reset Repeats to 1.

Change

Opens the Number of Repeats dialog box which allows you to determine how many times the animation will repeat itself. You can specify a number between 1 and 10,000.

Volume

Specifies the volume of the sound contained within your animation.

Volume:80

This is the default setting, and selecting this command will reset the volume of your project to 80.

Change

Opens the Sound Volume dialog box. Specify a number between 1 and 100.

Full Screen

This command is only available to systems that support DirectX. It enables the project to run in full-screen mode.

Scale to Screen

This command is only available to systems that support DirectX, and will only work when Full Screen mode has been selected. It will scale the image to fit the entire size of your screen.

Use Best Mode

This item is only available to systems that support DirectX, and will only work when Full Screen mode has been selected. If this command is chosen, MainActor tries to find the best possible screen mode for the project which is available on your system. Otherwise, full screen playback will always use the screen mode of the OS user interface.

■ Toolbar

These commands allow you to control the behavior of the toolbar.

Active

When this command is activated, the toolbar appears underneath the MainActor VE menu. When this command is de-activated, the toolbar is removed. The default setting for this command is "on."

Context Help

When this command is activated, you will get help messages which describe the functions of the toolbar when your mouse rests over each button. When this command is de-activated, this context-sensitive help does not appear. The default setting for this command is "on."

■ Language

Sets the default language of the program. Note that MainActor VE must be restarted for changes to take effect.

English

This command sets the default language of the program to English.

German

This command sets the default language of the program to German.

■ Mini Icons

This command toggles the size of the frame icons in the Frame View area from large to small.

■ Font

This command allows you to define the system dialog font throughout the application.

Help

■ Context Sensitive Help

Selecting this menu item turns the cursor into a question mark shape. When you click the cursor on a part of the window, help for that area will be displayed.

■ About Context Sensitive Help

Displays information on using context sensitive help.

■ MainActor Documentation

Displays the MainActor online documentation.

■ MainActor Rexx Reference

Displays the online reference for the MainActor-specific Rexx commands.

■ Rexx Introduction

This command will open the Rexx Introduction and tutorial help screen.

■ Rexx Reference

This command will open the Rexx Reference help screen.

■ Loader Modules

This command allows you to view all of the file formats and codecs that MainActor can load and play.

■ Saver Modules

This command allows you to view all of the file formats and codecs that MainActor can save projects as.

■ Product Info

This command opens the product information dialog box.

The Save Window

This section describes the Save window in detail. The Save window is used to create the animation, bitmap, and sound files of your project.

Module

This list allows you to determine the file format of the project (or individual frames from that project you are extracting).

When selecting a file format, be careful to choose a format that is appropriate for what you are actually doing. If you are extracting files from a video clip, don't save them as AVIs or in Quicktime MOV format -- save them as GIFs, JPEGs, or TGA. If you are extracting five frames from a 40 frame animation and choose AVI as your file format, those five frames will be linked to create a 5-frame AVI. If you're just trying to extract part of a movie as a smaller movie this is fine, but if you're trying to extract the frames to alter them or display them as graphics, you need to save them in a graphic format. Likewise, if the project is a 40 frame animation, if you select the JPEG format then MainActor VE will save your product as 40 separate JPEG files.

This may seem self explanatory, but all of the file formats are thrown together in the same list, and it's possible to accidentally select a format that is unsuitable for your purposes.

Type

Type tells you whether the Module you have selected is a picture (still) or animation (moving picture) format. Use modules classified as "picture" if you are trying to extract frames from movies to use as graphics; use modules classified as "animation" if you are converting a series of frames into an animation or a movie, or are converting an animation from one format to another.

Codec

The Codec listbox allows you to specify certain characteristics of the Module you have selected. For example, if you have chosen the Module "AVI", the Codec listbox allows you to specify the AVI as one of the following:

- 256 Colors: Microsoft RLE
- 256 Colors: Uncompressed
- Millions of Colors: Intel Indeo(TM) R3.1
- Millions of Colors: Motion JPEG
- Millions of Colors: Ultimotion(TM) IBM
- Millions of Colors: Uncompressed

Each of these choices will affect the size and image quality of the file.

Width

It is possible to change the default width (in pixels) of the picture or animation by highlighting the number already in this field, deleting it, and typing in a new one. Smaller sizes generally produce smaller files, larger sizes generally produce larger files.

Height

It is possible to change the default height (in pixels) of the picture or animation by highlighting the number already in the field, deleting it, and typing in a new one. Smaller sizes generally produce smaller files, larger sizes generally produce larger files.

Time

When you save an animation, the Time counter will count up the total length of the animation as the save process progresses.

Index

If you are extracting multiple frames from an animation and saving them as a picture, they will be saved under the same name with a four-digit number tagged onto the end of it, allowing you to a) identify them as coming from the same project, and b) identify the order in which they appeared in that project. The number in the Index field is the "starting" point of this numbering system, so if the Index is set to "1" and you save four frames under the name of "frame", they will be named frame0001, frame0002, frame0003, and frame0004. Likewise, if the Index was set to "10" they would be named frame0010, frame0011, frame0012, and frame0013.

Progress

Keeps track of the saving process. When you actually begin to save your project (create your movie, or extract your frames) the progress indicator will show you how close the job is to being finished.

All Frames/Selected Frames toggle

The radio buttons for "All Frames" and "Selected Frames" allows you to specify whether or not you want the settings on this dialog box to affect the entire project, or only the frame or frames you have selected. If you select four frames in a 40 frame animation and want to extract them, choosing the "Selected Frames" radio button will allow you to do this. Choosing the "All Frames" radio button, however, will extract all 40 of the frames from the project.

Status

Usually "Idle" or "Saving", Status tells you what the program is currently doing.

Save...

When you have finished configuring the Save Window to your satisfaction, the Save... button will call up a file dialog box, allowing you to name and save your project.

Cancel

Cancel will close the Save Window without saving or modifying your project in any way.

Palette...

Animations and pictures that will be shown in only 256 colors often benefit from being optimized as an 8 bit image. The Palette... button will open the Palette Editor, which allows you to do this.

Options...

The Options... button opens the Save Options window, which allows you to define more specific properties of the project you are saving. The properties that can be set are

■ Interpolate pixels while scaling (default)

If you have altered the Height and Width fields in the Save Window, this setting will interpolate the projects pixels when scaling it to the new size, resulting in less blocky looking images.

■ Use error diffusion when reducing colors

When saving 8 bit (256 color or grayscale) animations and pictures, this option enables an error diffusion algorithm to dither the image data. This option is useful when saving deep, 24 bit projects to 8 bit projects, as it reduces the visible "artifacts" (rough areas that appear when colors don't blend smoothly) of the color reduction.

■ Module Options

The Module Options button opens the Module GUI Interface, if applicable. This allows you to set options specific to a particular saver module.

Anhang C

MainActor Sequencer Command Reference

This appendix describes the menu commands of MainActor Sequencer.

Menu Commands

File

- **New**
Creates a new video sequencer project file.
- **Open... [Ctrl+O]**
Opens an existing video sequencer project file.
- **Save [Ctrl+S]**
Saves the current video sequencer project file. If the current project is unnamed, a file dialog will appear and allow you to specify a path name for the file.
- **Save as.. [Ctrl+A]**
Opens a file dialog that allows you specify the path and filename to save a video sequencer project.
- **Export...**
Allows you to export your video sequencer project to any supported file type such as MPEG.
- **Exit [Ctrl+Q]**
Closes MainActor Sequencer. If you have any unsaved changes, you will be prompted to save or discard them.

Edit

- **Undo: [Ctrl+Z]**
Undoes the last action. Each successive click undoes the next most recent action. The number of undo levels is set in the Preferences dialog.
- **Redo: [Ctrl+Y]**
Re-applies the action that was undone. Successive clicks redo successive undo actions.
- **Clear Undo History**

Clears the buffer containing all of the actions that can be undone. After selecting this, you will not be able to undo any actions done previously.

■ **Cut [Ctrl+X]**

Removes the selected item and places it in the clipboard.

■ **Copy [Ctrl+C]**

Copies the selected item(s) to the clipboard.

■ **Paste [Ctrl+V]**

Pastes the contents of the clipboard to the current cursor location.

■ **Delete [Del]**

Deletes the selected item(s), but does not copy it to the clipboard.

■ **Preferences...**

Opens the Preferences dialog box, which allows you to set various program parameters (such as the number of displayed program tracks, or the number of undo levels.)

Object

■ **Copy Object to Library [Ctrl+L]**

Copies the object currently selected on the timeline to the object library for use at a later time.

■ **Information [Ctrl+I]**

Opens the Object Information dialog box, which displays information about the object currently selected on the timeline.

■ **Video Path... [Ctrl+P]**

Opens the Video Path dialog box, which allows you to change the video path used by the object currently selected on the timeline.

■ **Video Effects... [Ctrl+E]**

Opens the Video Effects dialog box, allowing you to select various video effects (Blue, Brightness/Contrast, etc.) to be applied to an object selected on the timeline.

■ **Video Settings... [Ctrl+N]**

Opens the Video Settings dialog box, allowing you to change settings for things like video position and the alpha channel for an object.

■ **Audio Effects... [Ctrl+D]**

Opens the Audio Effects dialog box, allowing you to select various audio effects (band pass filter, echo, reverb, etc.) to be applied to an audio object selected on the timeline.

- **Settings... [Ctrl+T]**

Opens the Object Settings dialog box, allowing you to set various parameters for the object currently selected in the timeline.

- **Overlay Settings... [Ctrl+R]**

Opens the Overlay Settings dialog box, allowing you to define which portion of the overlay object (an object in the V1 - V96 tracks) is transparent.

- **Reset Volume Controls [Ctrl+U]**

Causes the volume control settings to revert to the default values.

- **Split Object... [Ctrl+J]**

Splits the audio and video information of an animation into separate objects. This is useful if you need to adjust the video/audio sync.

View

- **Background Render Window**

Toggles the display of the Background Render window which shows the progress of background rendering tasks.

- **Browser Window**

Toggles the display of the Browser window.

- **Preview Window**

Toggles the display of the Preview Window.

Help

- **Context Sensitive Help**

Selecting this menu item turns the cursor into a question mark shape. When you click the cursor on a part of the window, help for that area will be displayed.

- **About Context Sensitive Help**

Displays information on using context sensitive help.

- **Sequencer Documentation**

Opens the MainActor Sequencer online documentation file.

- **Product Info...**

Opens the product information

Index

- **!**
 - 3D Text Configuration Window 38
- **A**
 - Adding Effects to a Video Track 44
 - Animation 3
 - Audio Effects 50
 - AVI 60, 65
- **B**
 - BMP 60, 65
 - Browse Your Computer 51
 - Browser Window 49
- **C**
 - Color Selection Dialog 48
 - compression 56
 - Context Sensitive Help 12, 26
 - Converting Video Formats 13
 - Creating a MainActor Sequencer Project 27
 - Creating an Animated GIF 15
 - creating movie-styled credits 33
- **D**
 - DirectX 2
 - DL 60
- **E**
 - Electronic Documentation 26
 - Export Dialog 31
 - Extracting Frames from an Animation 20
- **F**
 - FLC 61, 65
 - FLI 61, 66
 - Frame 3
- **G**
 - GIF 61, 66
 - GIF - Anim 61, 66
 - Global Timecode 18
- **H**
 - How to capture a frame sequence 54
 - How to capture a single frame 54
 - How to capture video 55
- **I**
 - IFF 61
 - IFF - Anim3 62
 - IFF - Anim5 62
 - IFF - Anim7 62
 - IFF - Anim8 62
 - IFF - AnimJ 62
 - Import/Export Modules 50
- **J**
 - JPEG 66
- **L**
 - Library 51
 - light source (3D text) 42
 - lossless compression 56
 - lossy compression 56
- **M**
 - MacPICT 67
 - MainActor Electronic Documentation 12
 - MainActor Sequencer 1, 23
 - MainActor Sequencer Profile Window 24
 - MainActor Sequencer Timeline 25
 - MainActor Sequencer Toolbar 24
 - MainActor VE Frame List 10
 - MainActor VE Project List 10
 - MainActor VE Toolbar 10
 - MainActor Video Capture 1
 - MainActor Video Editor 1, 9
 - MainConcept's web site 3
 - MainView 1
 - MMX 2
 - Module 3
 - MPEG 63
 - MPEG - Audio 67
 - MPEG - I 67
 - MPEG - I/II 68
 - MPEG-Audio 63

■ O		■ T	
Overlaying 3D Animated Text	37	text path	40
Overlaying Scrolling Text	32	texture mapping	42
■ P		TGA	64
PCX	63	Tracks	25
PNG	63, 68	■ V	
PPM,PGM,PB	68	Video Data	69
PPM,PGM,PBM	63	Video Effects	50
Profile Window	27	Video Paths	50
Project	3	Video Transitions	49
■ Q		■ W	
QuickTime	64, 69	WAV	64
■ R			
rotating 3D text	41		