

SECTION 4. PROBLEM DETERMINATION PROCEDURES

Contents

Introduction	4-3
Checking Electrical Connections	4-5
Power-On Self-Test	4-8
Error Examples	4-11
Diagnostic Testing	4-15
IBM Printer Problem Determination Procedures	4-66
IBM Color Display Problem Determination Procedures	4-69

Notes:

Introduction

The Problem Determination Procedures help you to solve operational or system failures. By following the step-by-step procedures and answering yes or no to the questions asked, you will be able to determine what you must do to make your system operational again. Once you have determined which unit of your IBM Personal Computer has a problem, have the failing unit serviced.

As part of your problem determination, you may have to load the Diagnostics diskette (the diskette is at the back of this manual). The Diagnostics diskette has a series of tests to help you find a problem in any of the five units of your IBM Personal Computer. These five units are the system unit, expansion unit, keyboard, display, and printer.

For any problem start on the following page with "Checking Electrical Connections."

Notes:

Checking Electrical Connections

1. Set the Power switch of the system unit (and expansion unit, if attached) to Off.
2. Power off all externally attached devices (printer, TV, etc.).
3. Disconnect all non-IBM devices, except the display.
4. Unplug the system unit's (and expansion unit's) power cord from the wall outlet.

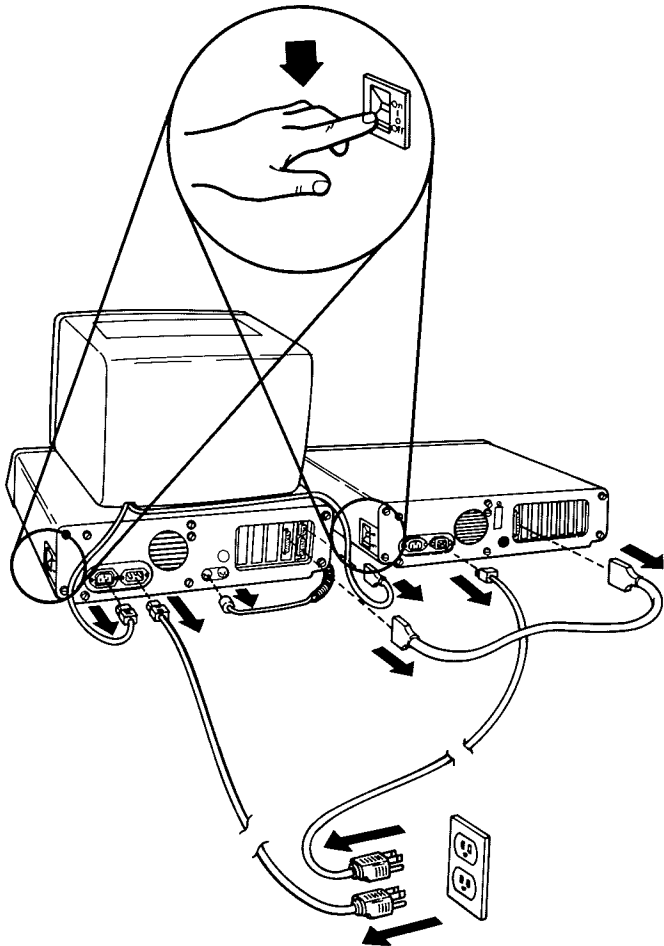

5. Check the wall outlet by plugging in a working lamp.
6. Disconnect and reconnect each cable on the system unit and the expansion unit (if attached) to ensure proper electrical connection.

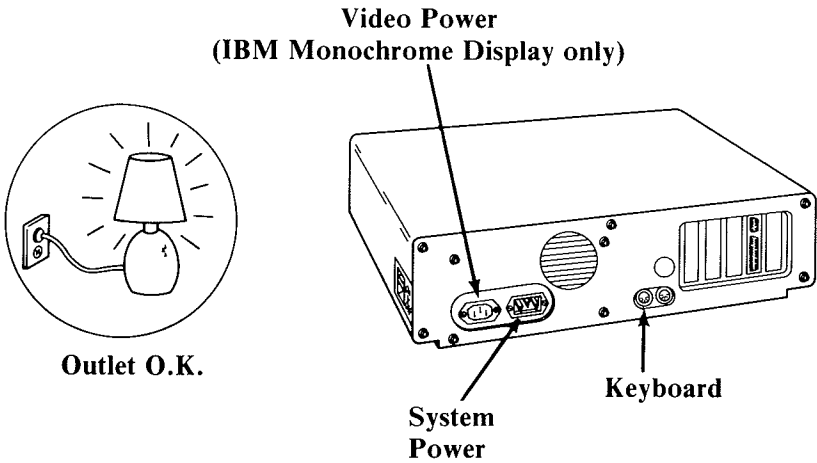

7. If you do not have any IBM Communications Adapter Cables attached to your Personal Computer, go to "Power-On Self Test" on the following page.
8. If you have an IBM Communications Adapter Cable, it came with a wrap plug. Disconnect the Communications Adapter Cable at the modem end (refer to the Communications Adapter Option Installation instructions for cable removal).
9. Refer to the figure below and install the wrap plug (IBM number 8529280) on the modem end of the cable (end furthest from the IBM Personal Computer).

Proceed with "Power-On Self-Test" on following page.

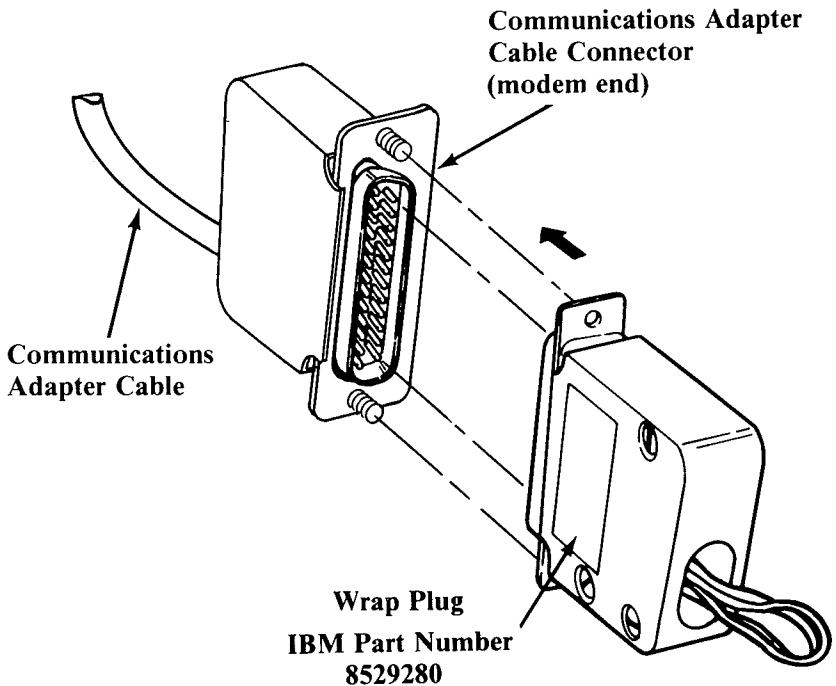

Power-On Self Test

1. Turn Brightness and Contrast knobs fully clockwise.

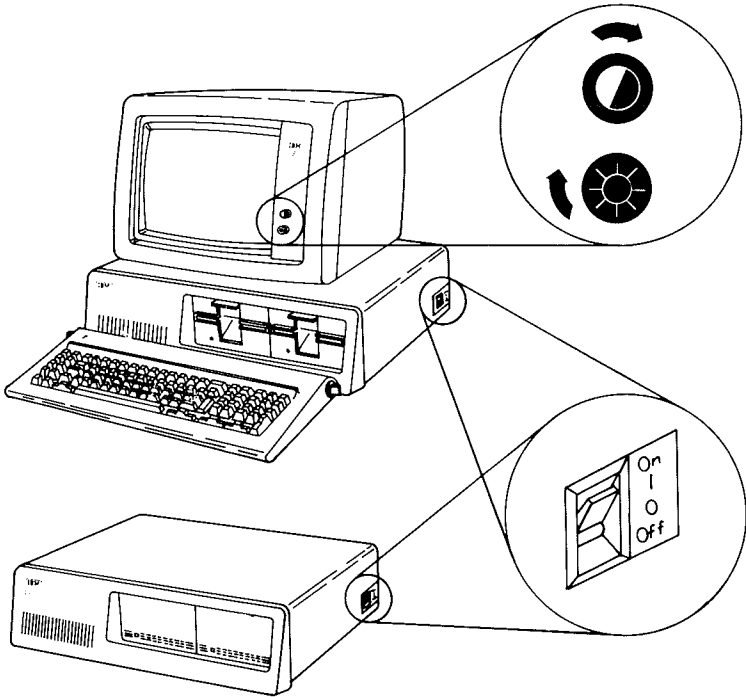

2. Power on all externally attached devices (printer, TV, etc.).
3. If an expansion unit is attached, set the Power switch to On.
4. Set the system unit Power switch to On.

POST will complete in 3 to 90 seconds, depending on the amount of memory installed in your system.

One short beep will be heard when the test is complete.

1

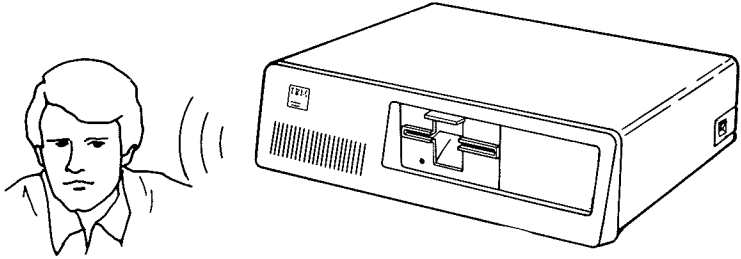

The "IBM Personal Computer Basic" message will appear. (If, at the end of POST, a diskette or an operating system from the fixed disk drive is automatically loaded, the initial screen from the diskette or the operating system will appear).

2

```
The IBM Personal Computer Basic  
Version X.XX Copyright IBM Corp XXXX  
XXXXX Bytes free  
OK
```

```
1LIST 2RUN 3LOAD" 4SAVE 5CONT 6LPT1 '7TRON 8TROFF 9KEY 0SCREEN
```

3

A blinking cursor will appear.

Did all three of the above occur?

YES - Go to "Diagnostic Testing."

NO - Go to "Error Examples."

Error Examples

Find the incorrect response in the following examples, then follow the instructions in the box marked "Action."

WARNING: If you are having the expansion unit serviced, it is recommended that you back-up all files on the fixed disk drive onto diskettes. Normal shipping and handling can result in permanent loss of data on your fixed disk drives. Depending on the amount of data stored, you may require approximately 64 diskettes to back-up each fixed disk drive. Refer to the IBM Disk Operating System for a description of the BACKUP Command.

Example 1

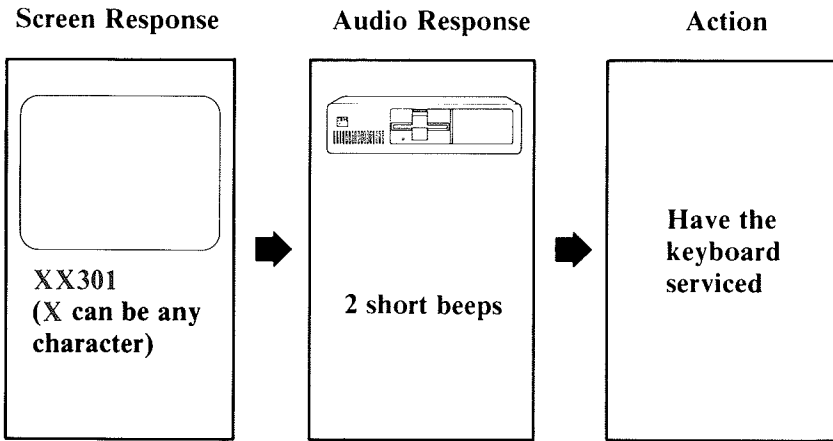

Example 2

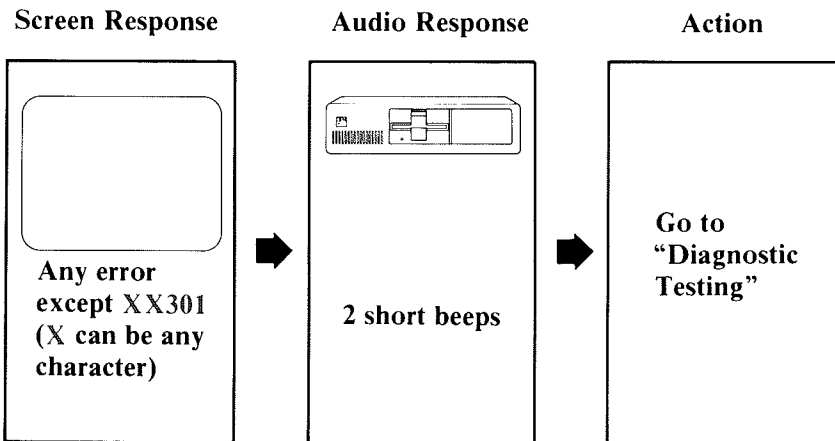

Example 3

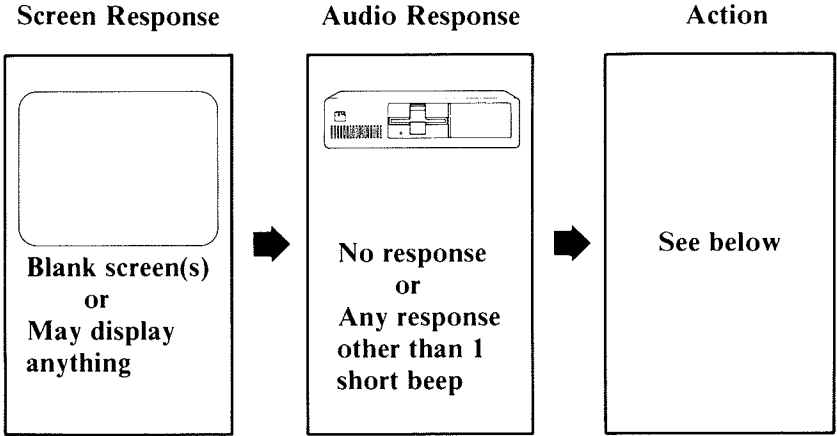

Do you have an expansion unit attached?

NO - Have the system unit serviced.

- YES** - a. Set the system unit and expansion unit Power switches to Off.
- Set all external power switches off (printer, TV, etc.).
 - Disconnect the expansion unit cable from the system unit.
 - Set the system unit Power switch to On.

If the error is the same, have the system unit serviced. If the error changes, have the expansion unit and expansion unit cable serviced.

Example 4 Color Display only

Screen Response

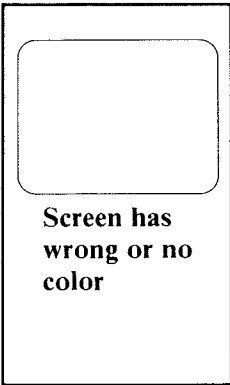

Audio Response

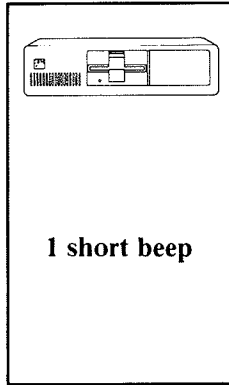

Action

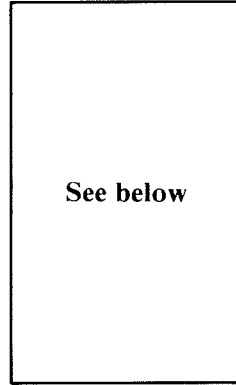

If you are using a TV as your display, verify that the color is correct by disconnecting your TV from the unit. Operate your TV normally to verify color quality. If you have an IBM Color Display, go to "IBM Color Display Problem Determination Procedures."

Example 5

Screen Response

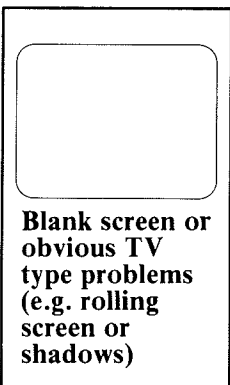

Audio Response

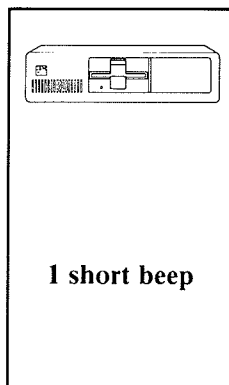

Action

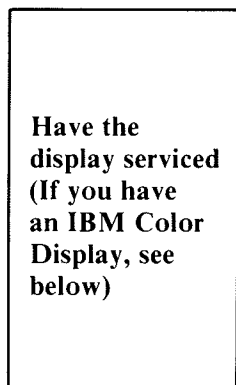

If you have an IBM Color Display, go to "IBM Color Display Problem Determination Procedures."

Diagnostic Testing

During the diagnostic tests, you may be asked to record an error message. This information is needed to aid you in getting your system serviced.

The following are examples of the error messages you may receive, and the probable reasons for the messages. A message ending in 00 means that the test has completed successfully.

Example 1.

```
XX:XX:XX  
ERROR - SYSTEM UNIT      XXXX
```

(X can be any character)

Have the system unit serviced.

Example 2.

```
XX:XX:XX  
ERROR - EXPANSION UNIT   XXXX
```

(X can be any character)

Have the expansion unit and expansion unit cable serviced.

1. Get the Diagnostics diskette from the back of this manual.

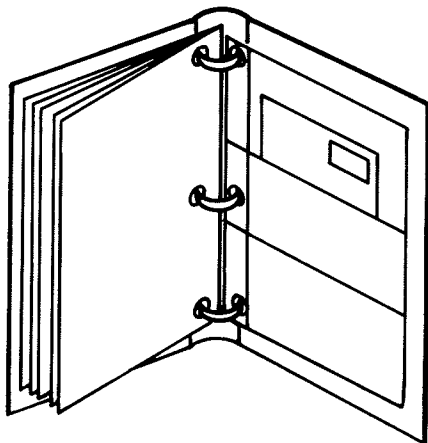

2. Set the Power switch on the system unit (and expansion unit, if attached) to Off.
3. Set all external power switches off (printer, TV, etc.).
4. Raise the load lever.
5. Insert the Diagnostics diskette into drive A.
6. Push the load lever down.
7. Power on all externally attached devices (printer, TV, etc.).
8. If an expansion unit is attached, set the Power switch to On.
9. Set the system unit's Power switch to On.

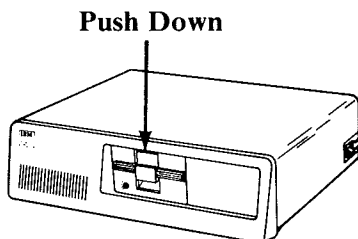
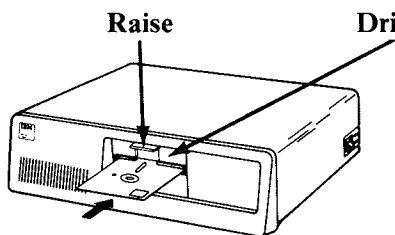

10. Did the following appear on your screen?

The IBM Personal Computer DIAGNOSTICS
Version XXX (C) Copyright IBM Corp XXXX
SELECT AN OPTION
0 - RUN DIAGNOSTIC ROUTINES
1 - FORMAT DISKETTE
2 - COPY DISKETTE
3 - PREPARE SYSTEM FOR RELOCATION
9 - EXIT TO SYSTEM DISKETTE
ENTER THE ACTION DESIRED

YES - Go to Step 11.

NO - Remove the diskette and verify that it:

- Is the Diagnostics diskette
- Was inserted incorrectly

Correct any mistakes. If the Diagnostics diskette was inserted correctly, the system unit is at fault.

Note: If you are using your home television or non-IBM display, you could experience data errors while using your diskette drive. This interference is easily corrected by moving your television or display a minimum of 12 inches away from your IBM Personal Computer.

11. Press



to select **FORMAT DISKETTE** then

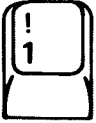
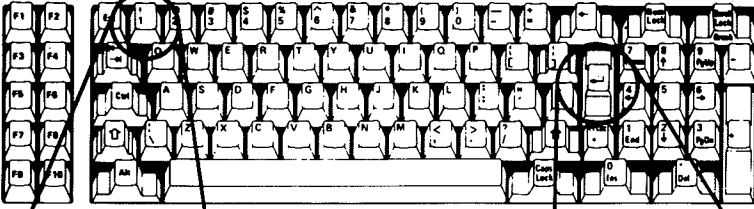

12. Did the following appear on your screen?



The IBM Personal Computer DIAGNOSTICS
Version XXX (C) Copyright IBM Corp XXXX
SELECT AN OPTION
0 - RUN DIAGNOSTIC ROUTINES
1 - FORMAT DISKETTE
2 - COPY DISKETTE
3 - PREPARE SYSTEM FOR RELOCATION
9 - EXIT TO SYSTEM DISKETTE
ENTER THE ACTION DESIRED
? 1
WHICH DRIVE CONTAINS DISKETTE
TO BE FORMATTED?

YES - Go to Step 13.

NO - Have your keyboard serviced.

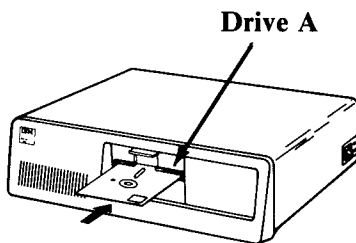
13. Remove the Diagnostics diskette from drive A and insert a blank diskette.



14. Press  then  .

The blank diskette will be formatted. The in-use light will be on during formatting.

When the in-use light goes out, remove the formatted (scratch) diskette.

Note: A formatted diskette that has no data stored on it is called a *scratch* diskette.

15. Insert the Diagnostics diskette into drive A.

Did the following appear on your screen without any additional messages?

SELECT AN OPTION

0 - RUN DIAGNOSTIC ROUTINES

1 - FORMAT DISKETTE

2 - COPY DISKETTE

3 - PREPARE SYSTEM FOR RELOCATION

9 - EXIT TO SYSTEM DISKETTE

ENTER THE ACTION DESIRED



YES - Press  then  .

If you have one display option installed in your system go to Step 17. If you have an IBM Monochrome Display and Printer Adapter and a Color/Graphics Monitor Adapter installed in your system, go to Step 16.

NO - Return to Step 13. Try another blank diskette. Be sure the diskette is inserted correctly. If the problem still exists, have the system unit serviced.

16. Do you have a monitor attached to each display adapter installed in your system?

IS A MONITOR ATTACHED TO EVERY DISPLAY ADAPTER (Y/N)?

YES - Press  then  and go to Step 17.

NO - Press  then  and go to Step 17.

17. Complete the list of installed devices and options and indicate their location with a check mark. Enter the amount of memory installed in your system.

System Unit	Expansion Unit	Installed Device/Option
		System Board
		XXX K of Memory
		Keyboard
		X Diskette Drive(s) and Adapter

Installed Devices, Options, and Memory



In the following sample "S" means the device is installed in the system unit, and "E" means the expansion unit.

18. Does your screen correctly list all your installed devices and options.

THE INSTALLED DEVICES ARE

S SYSTEM BOARD
S EXPANSION OPTION
S 256KB MEMORY
S KEYBOARD
S MONOCHROME & PRINTER ADAPTER
S COLOR/GRAPHICS MONITOR ADAPTER
S 2 DISKETTE DRIVE(S) AND ADAPTER
S GAME CONTROL ADAPTER
E 1 FIXED DISK DRIVE(S) & ADAPTER
S MATRIX PRINTER

IS THE LIST CORRECT (Y/N) ?

YES - Press  then  and go to Step 19.

NO - If the Matrix Printer was not listed, go to "Printer Problem Determination Procedures."
For all other devices or options incorrectly listed, if the option is installed in the system unit, have the system unit serviced. If the option is installed in the expansion unit, have the expansion unit serviced.

19. Press



to select **RUN TESTS ONE TIME**, then

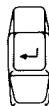

SYSTEM CHECKOUT

0 - RUN TESTS ONE TIME

1 - RUN TESTS MULTIPLE TIMES

2 - LOG UTILITIES

9 - EXIT DIAGNOSTIC ROUTINES

ENTER THE ACTION DESIRED

?

Is an expansion unit attached?

YES - Go to Step 20.

NO - Go to Step 27.

20. Did you receive an expansion unit error message
(18XX)?

SYSTEM CHECKOUT

- 0 - RUN TESTS ONE TIME
- 1 - RUN TEST MULTIPLE TIMES
- 2 - LOG UTILITIES
- 9 - EXIT DIAGNOSTIC ROUTINES

ENTER THE ACTION DESIRED

? 0

SYSTEM UNIT 100
EXPANSION UNIT 1800

THIS TEST TAKES UP TO TWO MINUTES
PLEASE STAND BY

YES - Go to Step 21.

NO - Go to Step 27.

21. Did you receive an 1819 error message (see the following)?

```
SYSTEM UNIT      100  
XX:XX:XX  
ERROR EXPANSION UNIT  1819  
PRESS ENTER TO CONTINUE
```

YES - If the following error message appears, the expansion unit is at fault. Have the expansion unit and the expansion unit cable serviced.

NO - Go to Step 22.

22. Did you receive an 1820 or 1821 error message?

SYSTEM UNIT 100

XX:XX:XX

ERROR EXPANSION UNIT 182X

PRESS ENTER TO CONTINUE

?

YES - Have the expansion unit and expansion unit cable serviced.

- NO** - a. Set the Power switches on the system unit and expansion unit to Off.
b. Set all external power switches off (printer, TV, etc.).
c. Disconnect the expansion unit cable from the system unit.
d. Set the system unit's Power switch to On.
e. Go to Step 23.

23. Press  to select **RUN DIAGNOSTIC ROUTINES**,

then  .

**THE IBM PERSONAL COMPUTER DIAGNOSTICS
VERSION XXX (C) COPYRIGHT IBM CORP XXXX**

SELECT AN OPTION

0 - RUN DIAGNOSTIC ROUTINES

1 - FORMAT DISKETTE

2 - COPY DISKETTE

3 - PREPARE SYSTEM FOR RELOCATION



9 - EXIT TO SYSTEM DISKETTE

ENTER THE ACTION DESIRED

If you have one display option installed in your system, go to Step 25. If you have an IBM Monochrome Display and Printer Adapter and a Color/Graphics Monitor Adapter installed in your system, go to Step 24.

24. Do you have a display attached to each display adapter installed in your system?

IS A MONITOR ATTACHED TO EVERY DISPLAY ADAPTER (Y/N)?

YES - Press  then  and go to Step 25.



NO - Press  then  and go to Step 25.

- 25.** Are any of the options or devices installed in your expansion unit missing from the list?

THE INSTALLED DEVICES ARE

S SYSTEM BOARD
S EXPANSION OPTION
S 256KB MEMORY
S KEYBOARD
S MONOCHROME PRINTER ADAPTER
S COLOR/GRAPHICS MONITOR ADAPTER
S 2 DISKETTE DRIVE(S) AND ADAPTER
S GAME CONTROL ADAPTER
E 1 FIXED DISK DRIVE(S) & ADAPTER
S MATRIX PRINTER

IS THE LIST CORRECT (Y/N) ?

YES - Press  then  and go to Step 26.

NO - Have the system unit serviced.

26. Press  to select RUN TESTS ONE TIME then  .

SYSTEM CHECKOUT

- 0 - RUN TESTS ONE TIME
- 1 - RUN TESTS MULTIPLE TIMES
- 2 - LOG UTILITIES
- 9 - EXIT DIAGNOSTIC ROUTINES

ENTER THE ACTION DESIRED

?

Did you get an 1820 error message?

YES - Have the expansion unit and expansion unit cable serviced.

NO - Have the system unit serviced.

27. Did the following appear on your screen?

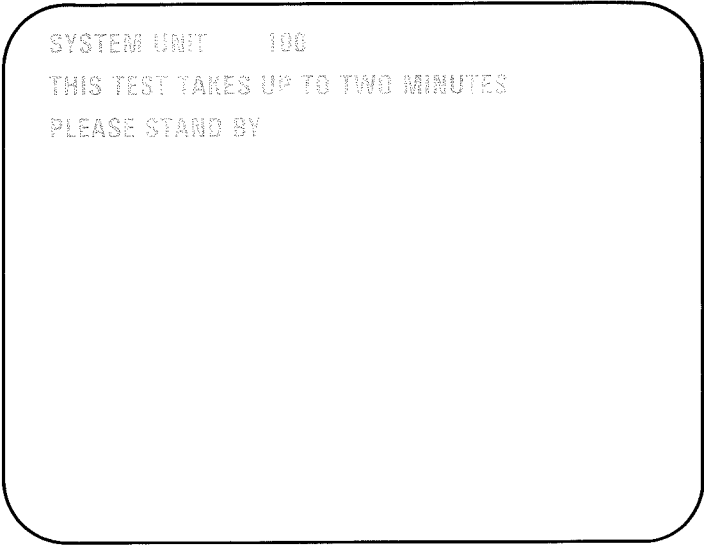

SYSTEM UNIT 100
THIS TEST TAKES UP TO TWO MINUTES
PLEASE STAND BY

YES - Go to Step 28.



NO - Have the system unit serviced.

28. Did the following appear on your screen?



PRESS EACH KEY, HOLD FOR TYPOMATIC TEST
IF OK PRESS "Y ENTER"
IF NOT OK PRESS "N ENTER"

YES - Press each key once, then go to Step 29.

NO - Press  then . Record the error message. Have the system unit serviced.



29. Did the following appear on your screen?



```
1 2 ← 1 2 3 4 5 6 7 8 9 0 - = ↔ N S
3 4 L Q W E R T Y U I O P [ ] 7 8 9 -
5 6 C A S D F G H J K L ; ' ' R 4 5 6
7 8 S \ Z X C V B N M , . / S * 1 2 3 +
9 0 A S C 0 .
```

**PRESS EACH KEY HOLD FOR TYPEMATIC TEST
IF OK PRESS "Y ENTER"
IF NOT OK PRESS "N ENTER"**

YES - Press and hold any key. The corresponding character on the screen will flash. This is the typematic test.

If the typematic test works correctly, press

 then  and go to Step 30. If the

typematic test failed, press  then .

Record the error message. Have the keyboard serviced.

NO - If any block did not change to a character, have the keyboard serviced.

30. Do you have an IBM Monochrome Display attached to your system?



NO - Go to Step 33.



YES - Did the following appear on your screen?

DISPLAY ATTRIBUTES
THIS LINE IS AT NORMAL INTENSITY.
THIS LINE IS INTENSIFIED.
THIS LINE IS IN REVERSE VIDEO.

THIS LINE IS BLINKING
THIS LINE IS UNDERLINED

IS THE SCREEN CORRECT? (Y/N)

YES - Press  then  and go to Step 31.

NO - Press  then . Record the error message.

If the following error message appears, the system unit is at fault. Have the system unit serviced.

XX:XX:XX
ERROR - SYSTEM UNIT XXXX
(X can be any character)

If the following error message appears, the expansion unit is at fault. Have the expansion unit and the expansion unit cable serviced.

XX:XX:XX
ERROR - EXPANSION UNIT XXXX
(X can be any character)

31. Did the following appear on your screen?

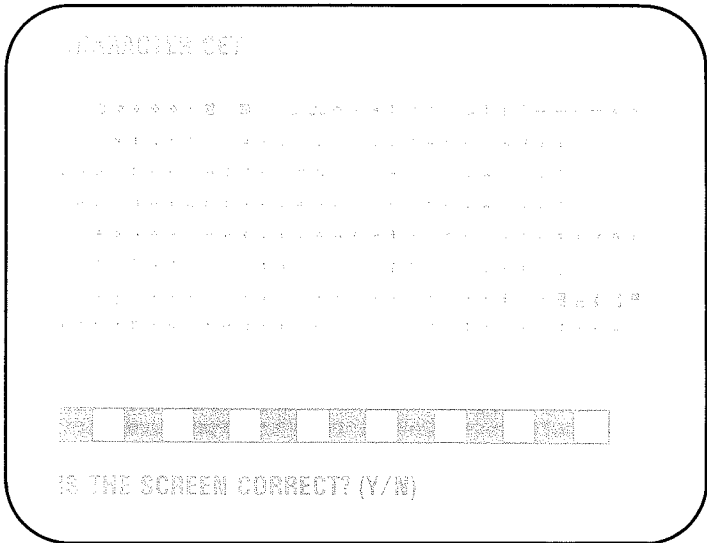

YES - Press  then  and go to Step 32.

NO - Press  then  . Record the error message.

If the following error message appears, the system unit is at fault. Have the system unit serviced.

```
XX:XX:XX  
ERROR - SYSTEM UNIT    XXXX  
(X can be any character)
```

If the following error message appears, the expansion unit is at fault. Have the expansion unit and the expansion unit cable serviced.

```
XX:XX:XX  
ERROR - EXPANSION UNIT  XXXX  
(X can be any character)
```

32. Did the following appear on your screen?



80X25 DISPLAY



```
! " # % & ' ( ) * + , - . / 0 1 2 3 4 5 6 7 8 9 ; < = > ? @ A B C D E F G H I J K L M N
! " # % & ' ( ) * + , - . / 0 1 2 3 4 5 6 7 8 9 ; < = > ? @ A B C D E F G H I J K L M N C
" # % & ' ( ) * + , - . / 0 1 2 3 4 5 6 7 8 9 ; < = > ? @ A B C D E F G H I J K L M N O F
# % & ' ( ) * + , - . / 0 1 2 3 4 5 6 7 8 9 ; < = > ? @ A B C D E F G H I J K L M N O P C
$ % & ' ( ) * + , - . / 0 1 2 3 4 5 6 7 8 9 ; < = > ? @ A B C D E F G H I J K L M N O P Q R
% & ' ( ) * + , - . / 0 1 2 3 4 5 6 7 8 9 ; < = > ? @ A B C D E F G H I J K L M N O P Q R E
& ' ( ) * + , - . / 0 1 2 3 4 5 6 7 8 9 ; < = > ? @ A B C D E F G H I J K L M N O P Q R S T
' ( ) * + , - . / 0 1 2 3 4 5 6 7 8 9 ; < = > ? @ A B C D E F G H I J K L M N O P Q R S T L
( ) * + , - . / 0 1 2 3 4 5 6 7 8 9 ; < = > ? @ A B C D E F G H I J K L M N O P Q R S T U V
) * + , - . / 0 1 2 3 4 5 6 7 8 9 ; < = > ? @ A B C D E F G H I J K L M N O P Q R S T U V W
* + , - . / 0 1 2 3 4 5 6 7 8 9 ; < = > ? @ A B C D E F G H I J K L M N O P Q R S T U V W X
+ , - . / 0 1 2 3 4 5 6 7 8 9 ; < = > ? @ A B C D E F G H I J K L M N O P Q R S T U V W X Y
, - . / 0 1 2 3 4 5 6 7 8 9 ; < = > ? @ A B C D E F G H I J K L M N O P Q R S T U V W X Y Z
. / 0 1 2 3 4 5 6 7 8 9 ; < = > ? @ A B C D E F G H I J K L M N O P Q R S T U V W X Y Z [ \
/ 0 1 2 3 4 5 6 7 8 9 ; < = > ? @ A B C D E F G H I J K L M N O P Q R S T U V W X Y Z [ \ ]
```

IS THE SCREEN CORRECT? (Y/N)

YES - Do you have a Color/Graphics Monitor Adapter installed in your system with a display attached to it?

NO - Press  then  and go to Step 43.

YES - Press  then  and go to Step 33.

NO - Press  then  . Record the error message.

If the error message is 432, go to "Printer Problem Determination Procedures."

If the following error message appears, the system unit is at fault. Have the system unit serviced.

XX:XX:XX
ERROR - SYSTEM UNIT XXXX
(X can be any character)

If the following error message appears, the expansion unit is at fault. Have the expansion unit and the expansion unit cable serviced.

XX:XX:XX
ERROR - EXPANSION UNIT XXXX
(X can be any character)

33. Did the following appear on your color display?

DISPLAY ATTRIBUTES

THIS LINE IS AT NORMAL INTENSITY.

THIS LINE IS INTENSIFIED.

THIS LINE IS IN REVERSE VIDEO.

THIS LINE IS BLINKING.

 **BLUE**

 **GREEN**

 **CYAN**

 **RED**



 **MAGENTA**

YELLOW

 **WHITE**

IS THE SCREEN CORRECT ? (Y/N)

YES - Press  then  and go to Step 34.

NO - Press  then  . Record the error message.

If the following error message appears, the system unit is at fault. Have the system unit serviced.

XX:XX:XX

ERROR - SYSTEM UNIT XXXX

(X can be any character)

If the following error message appears, the expansion unit is at fault. Have the expansion unit and the expansion unit cable serviced.

XX:XX:XX

ERROR - EXPANSION UNIT XXXX



(X can be any character)

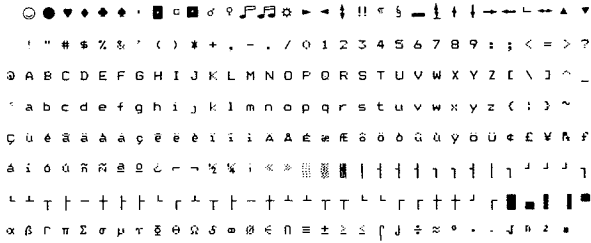

34. Did the following appear on your screen?

CHARACTER SET



IS THE SCREEN CORRECT? (Y/N)

YES - Press  then  and go to Step 35.

NO - Press  then  . Record the error message.

If the following error message appears, the system unit is at fault. Have the system unit serviced.

XX:XX:XX
 ERROR - SYSTEM UNIT XXXX
 (X can be any character)

If the following error message appears, the expansion unit is at fault. Have the expansion unit and the expansion unit cable serviced.



XX:XX:XX
 ERROR - EXPANSION UNIT XXXX
 (X can be any character)



35. Did the following appear on your screen?

80X25 DISPLAY

```
!"#%&'()*+,-./0123456789:;<=>?@ABCDEFGHIJKLMN  
!"#%&'()*+,-./0123456789:;<=>?@ABCDEFGHIJKLMN  
!"#%&'()*+,-./0123456789:;<=>?@ABCDEFGHIJKLMNOF  
!"#%&'()*+,-./0123456789:;<=>?@ABCDEFGHIJKLMNOFG  
!"#%&'()*+,-./0123456789:;<=>?@ABCDEFGHIJKLMNOFQR  
!"#%&'()*+,-./0123456789:;<=>?@ABCDEFGHIJKLMNOFQRS  
!"#%&'()*+,-./0123456789:;<=>?@ABCDEFGHIJKLMNOFQRST  
!"#%&'()*+,-./0123456789:;<=>?@ABCDEFGHIJKLMNOFQRSTL  
!"#%&'()*+,-./0123456789:;<=>?@ABCDEFGHIJKLMNOFQRSTU  
!"#%&'()*+,-./0123456789:;<=>?@ABCDEFGHIJKLMNOFQRSTUV  
!"#%&'()*+,-./0123456789:;<=>?@ABCDEFGHIJKLMNOFQRSTUVW  
!"#%&'()*+,-./0123456789:;<=>?@ABCDEFGHIJKLMNOFQRSTUVWX  
!"#%&'()*+,-./0123456789:;<=>?@ABCDEFGHIJKLMNOFQRSTUVWXY  
!"#%&'()*+,-./0123456789:;<=>?@ABCDEFGHIJKLMNOFQRSTUVWXYZ  
!"#%&'()*+,-./0123456789:;<=>?@ABCDEFGHIJKLMNOFQRSTUVWXYZ  
!"#%&'()*+,-./0123456789:;<=>?@ABCDEFGHIJKLMNOFQRSTUVWXYZ[\n/0123456789:;<=>?@ABCDEFGHIJKLMNOFQRSTUVWXYZ[\n]
```

IS THE SCREEN CORRECT ? (Y/N)

YES - Press  then  and go to Step 36.

NO - Press  then  . Record the error message.

If the following error message appears, the system unit is at fault. Have the system unit serviced.

```
XX:XX:XX  
ERROR - SYSTEM UNIT      XXXX  
(X can be any character)
```

If the following error message appears, the expansion unit is at fault. Have the expansion unit and the expansion unit cable serviced.

```
XX:XX:XX  
ERROR - EXPANSION UNIT    XXXX  
(X can be any character)
```



36. Did the following appear on your screen?

40X25 DISPLAY

```
!"#$%&'()*+,-./0123456789:;<=>?@ABCDEFGHI
!"#$%&'()*+,-./0123456789:;<=>?@ABCDEFGH
!"#$%&'()*+,-./0123456789:;<=>?@ABCDEFGH
!"#$%&'()*+,-./0123456789:;<=>?@ABCDEFGHI
!"#$%&'()*+,-./0123456789:;<=>?@ABCDEFGHIJ
!"#$%&'()*+,-./0123456789:;<=>?@ABCDEFGHIJK
!"#$%&'()*+,-./0123456789:;<=>?@ABCDEFGHIJKL
!"#$%&'()*+,-./0123456789:;<=>?@ABCDEFGHIJKLM
!"#$%&'()*+,-./0123456789:;<=>?@ABCDEFGHIJKLMN
!"#$%&'()*+,-./0123456789:;<=>?@ABCDEFGHIJKLMNO
!"#$%&'()*+,-./0123456789:;<=>?@ABCDEFGHIJKLMNOP
!"#$%&'()*+,-./0123456789:;<=>?@ABCDEFGHIJKLMNOPQ
!"#$%&'()*+,-./0123456789:;<=>?@ABCDEFGHIJKLMNOPQR
!"#$%&'()*+,-./0123456789:;<=>?@ABCDEFGHIJKLMNOPQRS
```

IS THE SCREEN CORRECT? (Y/N)

YES - Press  then  and go to Step 37.

NO - Press  then  . Record the error message.

If the following error message appears, the system unit is at fault. Have the system unit serviced.





```
XX:XX:XX
ERROR - SYSTEM UNIT      XXXX
(X can be any character)
```

If the following error message appears, the expansion unit is at fault. Have the expansion unit and the expansion unit cable serviced.

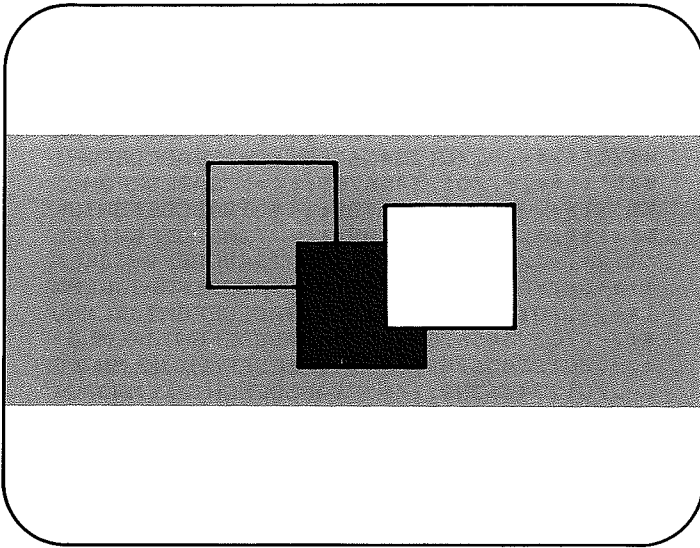
```
XX:XX:XX
ERROR - EXPANSION UNIT   XXXX
(X can be any character)
```

37. Did the following appear on your screen?



- YES - Press  then  and go to Step 38.
- NO - Press  then  . Record the error message.

If the following error message appears, the system unit is at fault. Have the system unit serviced.





XX:XX:XX
ERROR - SYSTEM UNIT XXXX
(X can be any character)

If the following error message appears, the expansion unit is at fault. Have the expansion unit and the expansion unit cable serviced.

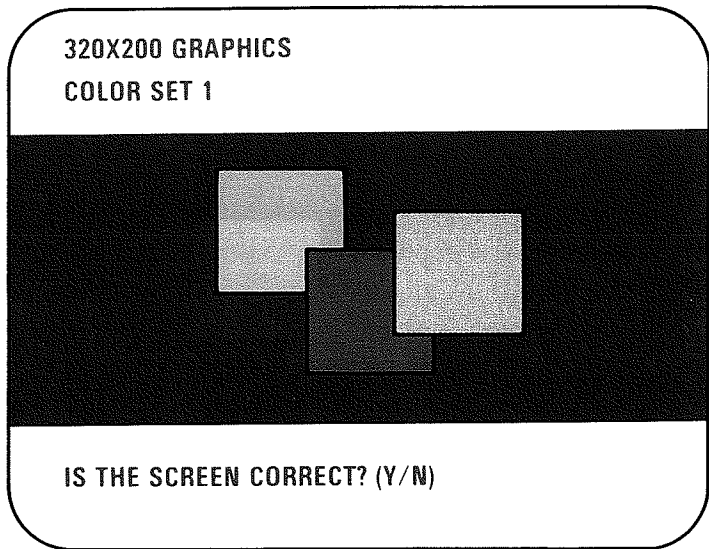
XX:XX:XX
ERROR - EXPANSION UNIT XXXX
(X can be any character)

38. Did the following appear on your screen?



- YES** - Press  then  and go to Step 39.
- NO** - Press  then  . Record the error message.

If the following error message appears, the system unit is at fault. Have the system unit serviced.





XX:XX:XX
ERROR - SYSTEM UNIT XXXX
(X can be any character)

If the following error message appears, the expansion unit is at fault. Have the expansion unit and the expansion unit cable serviced.

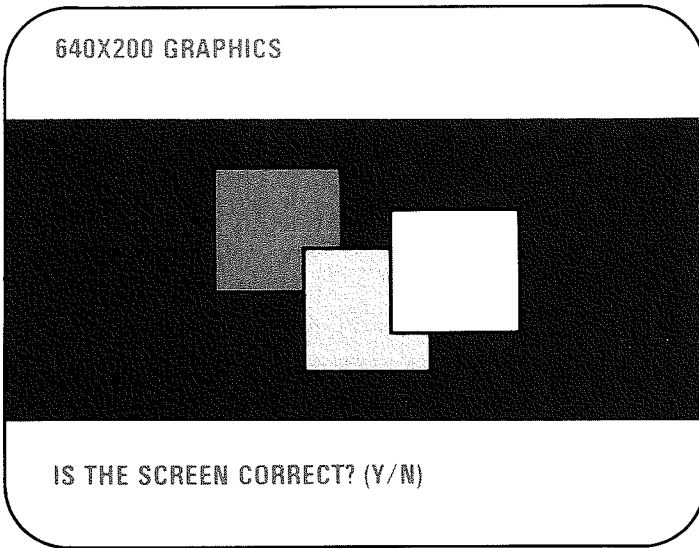
XX:XX:XX
ERROR - EXPANSION UNIT XXXX
(X can be any character)

39. Did the following appear on your screen?



- YES** - Press  then  and go to Step 40.
- NO** - Press  then  . Record the error message.

If the following error message appears, the system unit is at fault. Have the system unit serviced.

XX:XX:XX
ERROR - SYSTEM UNIT XXXX
(X can be any character)



If the following error message appears, the expansion unit is at fault. Have the expansion unit and the expansion unit cable serviced.

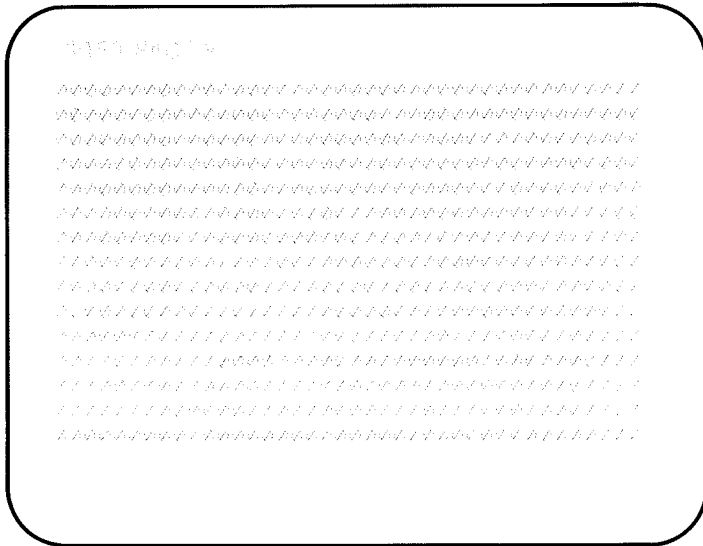

XX:XX:XX
ERROR - EXPANSION UNIT XXXX
(X can be any character)

41. Press any key, video page 1 will be displayed.
Continue to press any key until video page 0 is displayed.

42. Were all 8 pages displayed?



YES - Press  then  and go to Step 43.

NO - Press  then  . Record the error message.

If the following error message appears, the system unit is at fault. Have the system unit serviced.

XX:XX:XX
ERROR - SYSTEM UNIT XXXX
(X can be any character)

If the following error message appears, the expansion unit is at fault. Have the expansion unit and the expansion unit cable serviced.

XX:XX:XX
ERROR - EXPANSION UNIT XXXX
(X can be any character)

43. Remove the Diagnostics diskette.

Does your screen match the figure below?

XXX will be either 400 or 500.

```
SYSTEM UNIT   XXX
**** WARNING ****
DATA WILL BE DESTROYED
INSERT SCRATCH DISKETTE IN DRIVE A
PRESS ENTER WHEN READY
?
```

YES - Go to Step 44.

NO - Record the error message.

If the following error message appears, the system unit is at fault. Have the system unit serviced.

```
XX:XX:XX
ERROR - SYSTEM UNIT   XXXX
(X can be any character)
```

If the following error message appears, the expansion unit is at fault. Have the expansion unit and the expansion unit cable serviced.

```
XX:XX:XX
ERROR - EXPANSION UNIT   XXXX
(X can be any character)
```



- 44.** Insert a scratch diskette in drive A and press  . Did the following appear on your screen?



DISKETTE A IS A XXXKB DRIVE
IS THE DRIVE SIZE CORRECT (Y/N)?

If your diskette drive is a 160KB drive, XXX will be 160.

If your diskette drive is a 320KB drive, XXX will be 320.

YES - Press  then  . If you don't have two diskette drives installed in your system, go to Step 47.

NO - Have the system unit serviced.

45. The following will appear on your screen.

*** WARNING ***
DATA WILL BE DESTROYED
INSERT SCRATCH DISKETTE IN DRIVE B
PRESS ENTER WHEN READY
?

Remove the scratch diskette from drive A, place it in
drive B, and press





46. Did the following appear on your screen?

DISKETTE B IS A XXXKB DRIVE
IS THE DRIVE SIZE CORRECT (Y/N)?

If your diskette drive is a 160KB drive, XXX will be 160.

If your diskette drive is a 320KB drive, XXX will be 320.

YES - Press  then  and go to Step 47.

NO - Have the system unit serviced.

47. Is this message displayed longer than 10 seconds?



TESTING MATH COPROCESSOR

YES - Have the system unit serviced.

NO - Go to Step 48.

48. Did any of the following errors appear on your screen (X can be any character).

XX:XX:XX
ERROR - SYSTEM UNIT 7XX

XX:XX:XX
ERROR - SYSTEM UNIT 9XX

XX:XX:XX
ERROR - SYSTEM UNIT 11XX

XX:XX:XX
ERROR - SYSTEM UNIT 12XX

NO - Go to Step 50.

YES - Record the error message.

If the following error message appears, the system unit is at fault. Have the system unit service.



XX:XX:XX
ERROR - SYSTEM UNIT XXXX
(X can be any character)



If the following error message appears, the expansion unit is at fault. Have the expansion unit and the expansion unit cable serviced.



XX:XX:XX
ERROR - EXPANSION UNIT XXXX
(X can be any character)

49. Did the following appear on your screen?



DO YOU HAVE JOY STICKS, PADDLES,
OR NOTHING ATTACHED (J P N)?

YES - For joy sticks press  then  and go to Step 50.

For paddles press  then  and go to Step 53.

For nothing press  then  and go to Step 57.

NO - Go to Step 57.

50. Press  then  .

51. Check the correct operation of your joy sticks as follows:
- Press each button and watch the word **RELEASED** change to **PRESSED**.
 - Move each joy stick and watch the character, **A** or **B**, move inside the box.

52. Did all buttons and joy sticks operate correctly?

HOW MANY BUTTONS DO YOU HAVE (2/4)? 2

<p>BUTTON A RELEASED ***** * * * * * A * * * * * *****</p>	<p>BUTTON B RELEASED ***** * * * * * B * * * * * *****</p>
----------------------------------------------------------------------------------------------------------------------------------------------	----------------------------------------------------------------------------------------------------------------------------------------------

PRESS AND RELEASE ALL BUTTONS,
EXERCISE ALL JOY STICKS/PADDLES
AND PRESS ANY KEY WHEN DONE

- YES** - Press any key and go to Step 57.
- NO** - If the Game Control Adapter is installed in the system unit, have the joy sticks and the system unit serviced. If the Game Control Adapter is installed in the expansion unit, have the joy sticks and the expansion unit serviced.

53. Enter the number of paddles attached to your Game Control Adapter (2/4) and press .

54. Enter the same number for the number of buttons and press .

55. Check the correct operation of your paddles as follows:

- Press each button and watch the word **RELEASED** change to **PRESSED**.
- Turn each paddle control and watch the character, **A**, **B**, **C**, or **D** move inside the box.

56. Did all buttons and paddle controls operate correctly?

HOW MANY BUTTONS DO YOU HAVE (2/4)?

BUTTON A	BUTTON B	BUTTON C	BUTTON D
RELEASED	RELEASED	RELEASED	RELEASED
*****		*****	
* A *		* B *	
*****		*****	
*****		*****	
* C *		* D *	
*****		*****	

**PRESS AND RELEASE ALL BUTTONS,
EXERCISE ALL JOY STICKS/PADDLES
AND PRESS ANY KEY WHEN DONE**

YES - Press any key and go to Step 57.

NO - If the Game Control Adapter is installed in the system unit, have the paddles and the system unit serviced. If the Game Control Adapter is installed in the expansion unit, have the paddles and the expansion unit serviced.

57. Did the following error appear on your screen?

```
XX:XX:XX  
ERROR - SYSTEM UNIT    15XX
```

NO - Go to Step 58.

YES - Record the error message.

If the following error message appears, the system unit is at fault. Have the system unit and the IBM Communications Adapter Cable, if attached, serviced.

```
XX:XX:XX  
ERROR - SYSTEM UNIT    XXXX  
(X can be any character)
```

If the following error message appears, the expansion unit is at fault. Have the expansion unit, the expansion unit cable, and the IBM Communications Adapter Cable, if attached, serviced.



```
XX:XX:XX  
ERROR - EXPANSION UNIT  XXXX  
(X can be any character)
```

58. Do you have a fixed disk drive installed in your system?

NO - Go to Step 62.

YES - The following will appear on your screen.

*** WARNING ***
DATA ON CYLINDER 305 WILL BE
OVERWRITTEN BY FIXED DISK WRITE TESTS
DO YOU WANT TO INCLUDE FIXED DISK
WRITE TESTS ON DRIVE C: (Y/N) ?

Press  then  and go to Step 59.

59. Did the following appear on your screen?

```
*** WARNING ***  
DATA ON CYLINDER 305 WILL BE  
OVERWRITTEN BY FIXED DISK WRITE TESTS  
DO YOU WANT TO INCLUDE FIXED DISK  
WRITE TESTS ON DRIVE C: (Y/N) ? y  
PERFORMING SEEK TEST  
PERFORMING WRITE TEST  
PERFORMING TRACK ZERO TEST  
PERFORMING SURFACE SCAN  
PLEASE STAND BY
```

YES - If you have one fixed disk drive installed in your system, go to Step 62. If you have two fixed disk drives installed, go to Step 60.

NO - Record the error message.

If the following error message appears, the system unit is at fault. Have the system unit serviced.

```
XX:XX:XX  
ERROR - SYSTEM UNIT      XXXX  
(X can be any character)
```

If the following error message appears, the expansion unit is at fault. Have the expansion unit and the expansion unit cable serviced.

```
XX:XX:XX  
ERROR - EXPANSION UNIT   XXXX  
(X can be any character)
```

60. Did the following appear on your screen?

***** WARNING ***
DATA ON CYLINDER 305 WILL BE
OVERWRITTEN BY FIXED DISK WRITE TESTS
DO YOU WANT TO INCLUDE FIXED DISK
WRITE TESTS ON DRIVE D: (Y/N) ?**

YES - Press  then  and go to Step 61.

NO - Record the error message.

If the following error message appears, the system unit is at fault. Have the system unit serviced.

XX:XX:XX
ERROR - SYSTEM UNIT XXXX
(X can be any character)

If the following error message appears, the expansion unit is at fault. Have the expansion unit and the expansion unit cable serviced.

XX:XX:XX
ERROR - EXPANSION UNIT XXXX
(X can be any character)

61. Did the following appear on your screen?

```
DO YOU WANT TO INCLUDE FIXED DISK  
WRITE TESTS ON DRIVE D: (Y/N) ? y  
PERFORMING SEEK TEST  
PERFORMING WRITE TEST  
PERFORMING TRACK ZERO TEST  
PERFORMING SURFACE SCAN  
PLEASE STAND BY
```

YES - Go to Step 62.

NO - Record the error message.

If the following error message appears, the system unit is at fault. Have the system unit serviced.

```
XX:XX:XX  
ERROR - SYSTEM UNIT      XXXX  
(X can be any character)
```

If the following error message appears, the expansion unit is at fault. Have the expansion unit and the expansion unit cable serviced.

```
XX:XX:XX  
ERROR - EXPANSION UNIT    XXXX  
(X can be any character)
```

62. Did any of the following errors appear on your screen (X can be any character)?

```
XX:XX:XX  
ERROR - SYSTEM UNIT      20XX
```

```
XX:XX:XX  
ERROR - SYSTEM UNIT      21XX
```

NO - Go to Step 63.

YES - Record the error message.

If the following error message appears, the system unit is at fault. Have the system unit and the IBM Communications Adapter Cable, if attached, serviced.

```
XX:XX:XX  
ERROR - SYSTEM UNIT      XXXX  
(X can be any character)
```

If the following error message appears, the expansion unit is at fault. Have the expansion unit, the expansion unit cable, and the IBM Communications Adapter Cable, if attached, serviced.

```
XX:XX:XX  
ERROR - EXPANSION UNIT    XXXX  
(X can be any character)
```

63. If an IBM 80 CPS printer is attached, one of the following printer test patterns should result:

Matrix Printer

```
! " # $ % & ' ( ) * + , - . /
0 1 2 3 4 5 6 7 8 9 : ; < = > ?
@ ABCDEFGHIJKLMNOP
PQRSTUVWXYZ[\]^_
' abcdefghijklmno
p q r s t u v w x y z { | } ~
! " # $ % & ' ( ) * + , - . /
0 1 2 3 4 5 6 7 8 9 i j k l m n o p q r s t u v w x y z { | } ~
@ ABCDEFGHIJKLMNOP
PQRSTUVWXYZ[\]^_
' abcdefghijklmno
p q r s t u v w x y z { | } ~
! " # $ % & ' ( ) * + , - . /
. . . . .
```

Graphics Printer

```
! " # $ % & ' ( ) * + , - . /
0 1 2 3 4 5 6 7 8 9 : ; < = > ?
@ ABCDEFGHIJKLMNOP
PQRSTUVWXYZ[\]^_
' abcdefghijklmno
p q r s t u v w x y z { | } ~
! " # $ % & ' ( ) * + , - . /
0 1 2 3 4 5 6 7 8 9 i j k l m n o p q r s t u v w x y z { | } ~
@ ABCDEFGHIJKLMNOP
PQRSTUVWXYZ[\]^_
' abcdefghijklmno
p q r s t u v w x y z { | } ~
! " # $ % & ' ( ) * + , - . /
á ì ó ü ñ ò ã ä å æ ç è é ê ë ì « »
Σ π ϑ ρ σ Σ β Γ ϵ ζ η θ ω Ω
□ □ □ □
```

64. Did the printer test run error free and the printer test pattern print correctly?

YES - Go to Step 65.

NO - Record any error message. Go to "Printer Problem Determination Procedures."

65. You have completed the Problem Determination Procedures with no failures. Remove the Diagnostics diskette and return it to the back of this manual. Your IBM Personal Computer should be ready to load your operating system.

If you should encounter further problems, contact your place of purchase for additional information.

IBM Printer Problem Determination Procedures

Before you proceed, follow these preliminary steps:

- 1.** Check your wall outlet for proper operation (use a working lamp).
- 2.** Verify that your printer cable is properly connected.
- 3.** Verify that the printer is plugged into the wall outlet and is turned on.

Did you find any problem while following the above steps?

NO - Go to Step 4.

YES - Correct the problem and run the Diagnostics again.

- 4.** Set the Power switches on the printer, system unit (and expansion unit, if attached) to Off.
- 5.** Disconnect the printer cable from the printer.
- 6.** Run the printer self-test.

If you need help in doing this, refer to Section 3, "Operations," for the procedure.

Did the self-test run without failures?

YES - Go to Step 12.

NO - Go to Step 7.

- 7.** Check that your ribbon is installed properly.
- 8.** Check that your forms are inserted properly.
- 9.** Check that there are no obstructions in the forms path.
- 10.** Check that the tractors are adjusted properly.

If you need help with any of the above, refer to Section 3, "Operations."

Did you find any problem while following the above steps?

NO - Go to Step 11.

YES - Correct the problem.

- 11.** Do you have any of these problems?
 - a. Your printer beeps even though the paper is installed properly.
 - b. Your printer does not beep when it is out of paper.
 - c. Some of the lights on the control panel do not work.
 - d. Your printer continues to print when it is out of paper.

NO - Go to Step 15.

YES - Have your printer serviced.

12. Did you receive any of the following error messages?

199

432

901

1401

YES - Go to Step 13.

NO - Go to Step 15.

13. Leave the printer cable disconnected from the printer and run the Diagnostics again.

Note: "Matrix Printer" will be missing from the menu of installed devices when you run Diagnostics this time. Verify your menu of installed devices is correct (without the printer).

14. Did you receive the same error message when you ran Diagnostics this time?

YES - The problem is probably in the unit (system or expansion) that has the card your printer was attached to.

NO - Have the printer and cable serviced.

15. Your printer is also controlled by program commands from the system unit. If you have a printer problem only while running a particular program, examine the program thoroughly for commands being sent to the printer causing it to produce undesired results.

IBM Color Display Problem Determination Procedures

If your IBM Color Display requires service, it must be returned with the power cord.

1. Set the Power control to On.

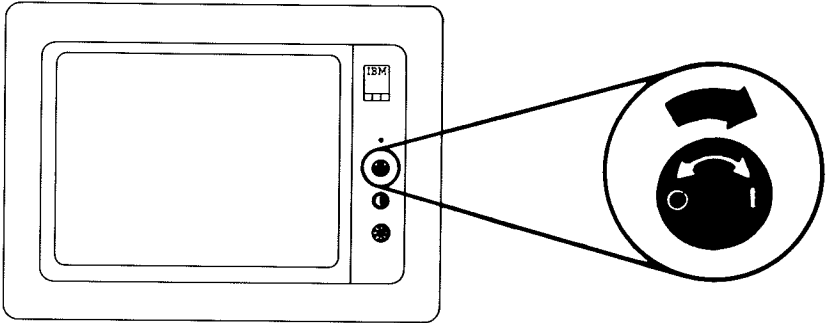

2. Is the Power-On indicator lit?

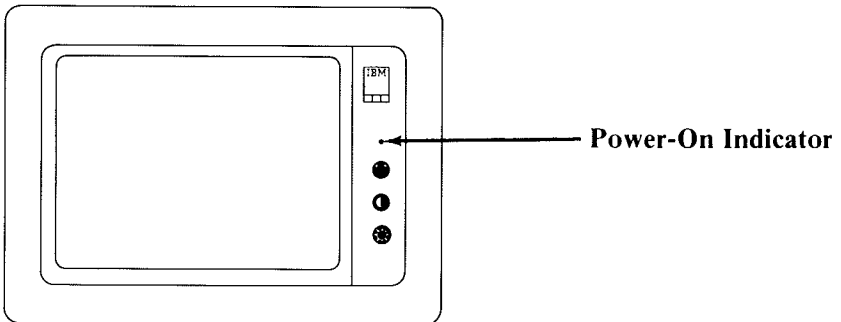

YES - Go to Step 3.

NO - Check that the power cord is plugged into a functioning wall outlet and the rear of the display. If it is, have the display serviced.

3. Set the Power switch on the system unit (and expansion unit, if attached) to Off.
4. Set the Brightness and Contrast controls fully clockwise.

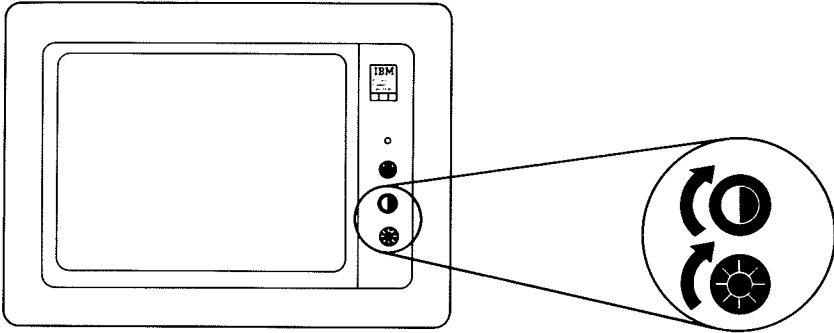

5. Turn the Vertical Size control fully counterclockwise. A black area should appear across the top and the bottom of the screen.

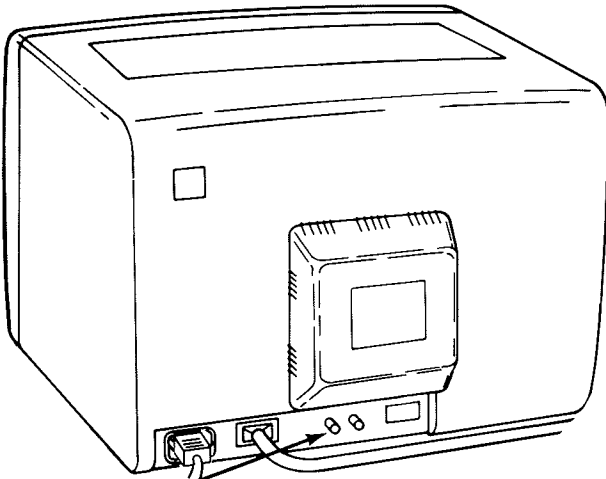

Vertical Size
Control

- 6.** Does a black area appear across the top and the bottom of the screen?

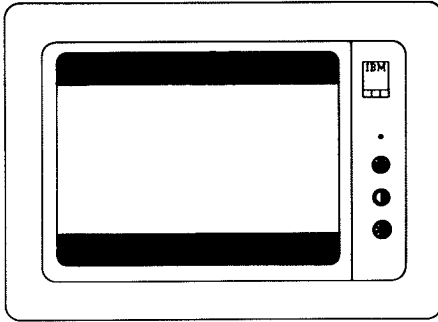

YES - Go to Step 7.

NO - Have the display serviced.

- 7.** Are the black areas at the top and bottom of the screen approximately equal in size?

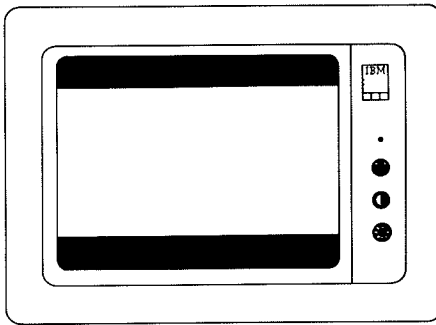

YES - Go to Step 8.

NO - Have the display serviced.

8. Turn the Vertical Size control clockwise until the black areas at the top and bottom of the screen just disappear. If one of the black areas disappears before the other, continue to turn the control until the second black area is gone.

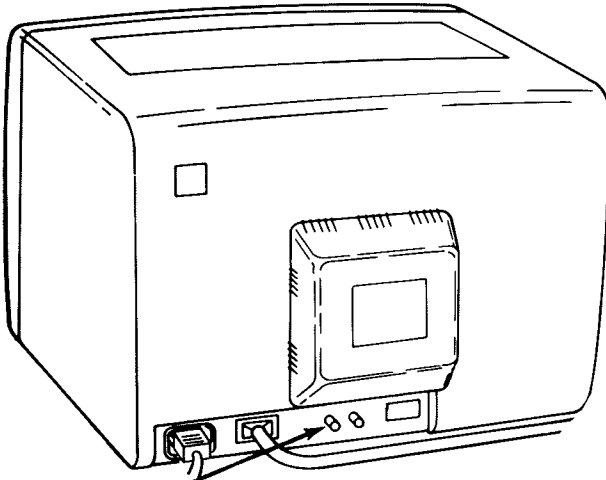

**Vertical Size
Control**

9. Is the screen all white?

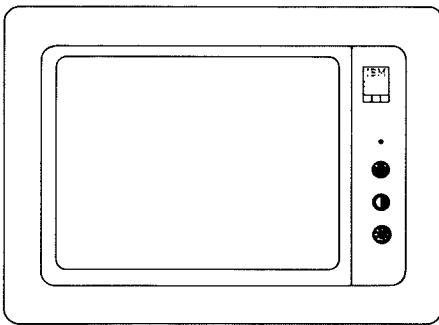

YES - Go to Step 14.

NO - Go to Step 10.

10. Set the Power control to Off.

11. Disconnect the display's signal cable from the Color/Graphics Monitor Adapter.

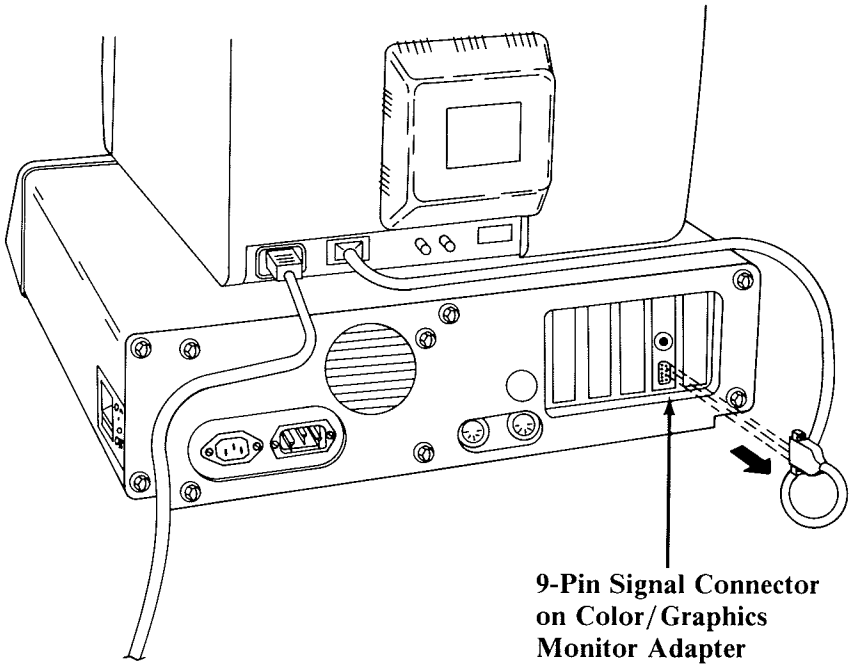

12. Set the Power control to On.

13. Is the screen white?

YES - Have the unit serviced that contains the Color/Graphics Monitor Adapter.

NO - Have the display serviced.

14. While watching the screen, set the Power switch on the expansion unit (if attached) and the system unit to On.

15. Did the screen change from white to black as soon as the Power switch on the unit having the Color/Graphics Monitor Adapter was set to On? (This totally black condition may last only 3 seconds before the display changes again.)

YES - Go to Step 16.

NO - Have the display serviced.

16. Wait for the Power-On Self Test (POST) to complete. The IBM Personal Computer Basic message will appear (if a diskette is not loaded or an operating system is not booted from the fixed disk drive) with a blinking cursor.

```
The IBM Personal Computer Basic  
Version X.XX Copyright IBM Corp XXXX  
XXXXX Bytes free  
OK
```

```
1LIST 2RUN 3LOAD" 4SAVE 5CONT 6LPT1 '7TRON 8TROFF 9KEY 0SCREEN
```

17. Is your screen blank?

NO - Go to Step 18.

YES - Have the unit serviced that contains the Color/Graphics Monitor Adapter.

18. Is your screen stable?

NO - Go to Step 19.

YES - Go to Step 21.

- 19.** Turn the Vertical Hold control clockwise as far as it will go, then turn it counterclockwise until the screen stops rolling and is stable.

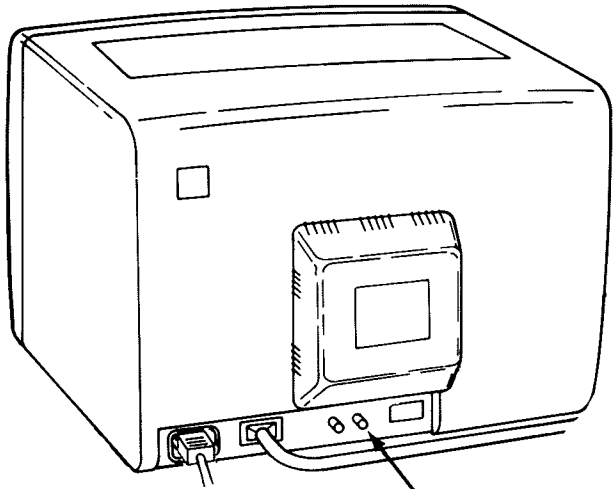

**Vertical Hold
Control**

- 20.** Were you able to make the screen stable?

YES - Go to Step 21.

NO - Have the display serviced.

- 21.** Look at the screen. Does it have white characters on a dark background?

YES - Go to Step 27.

NO - Go to Step 22.

- 22.** Set the Power switch on the system unit (and expansion unit, if attached) to Off.
- 23.** Set the display's Power control to Off.
- 24.** Disconnect the display's signal cable from the Color/Graphics Monitor Adapter.
- 25.** Set the display's Power control to On.
- 26.** Is the screen white?
- YES** - Have the unit serviced that contains the Color/Graphics Monitor Adapter.
- NO** - Have the display serviced.
- 27.** Turn the Brightness control fully counterclockwise.

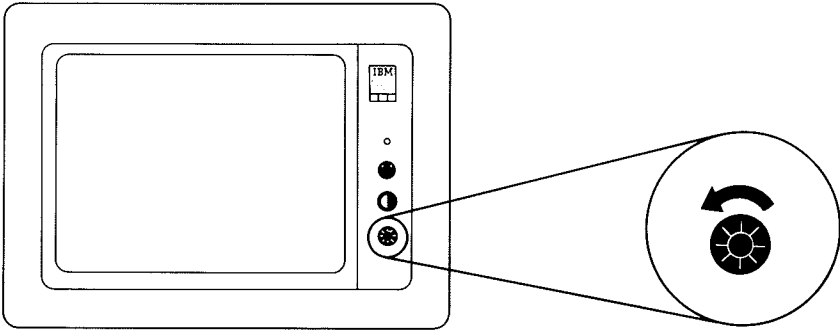

- 28.** Does the intensity of the characters decrease?
- YES** - Go to Step 29.
- NO** - Have the display serviced.

- 29.** Turn the Brightness control fully clockwise. Turn the Contrast control fully counterclockwise.

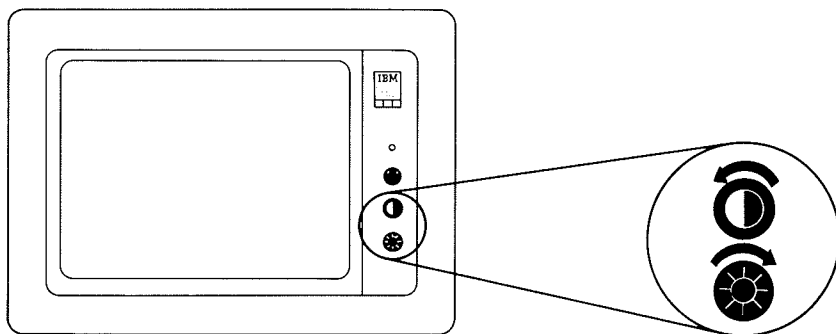

- 30.** Does the intensity of the characters decrease?

YES - Go to Step 31.

NO - Have the display serviced.

31. Turn the Contrast control fully clockwise. Look at the following examples.

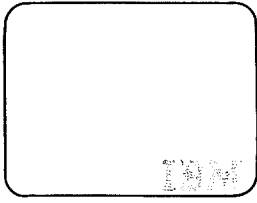

Too Dim

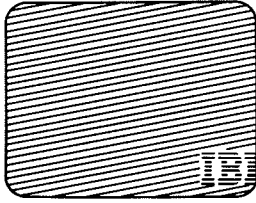

Too Wide

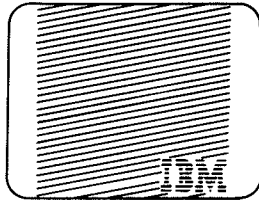

Too Narrow

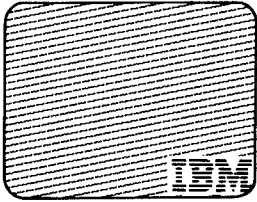

Out of Focus

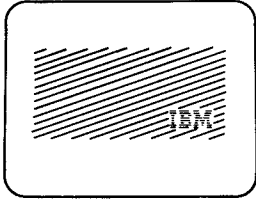

Shrunken

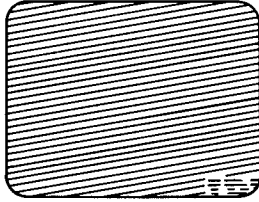

Characters shifted left or right or up and down off the display area

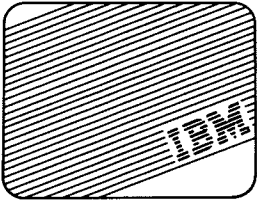

Tilted

32. Is your problem similar to one of the examples?

NO - Go to "Diagnostic Testing" in this section.

YES - Have the display serviced.