

# Aptiva Reference Guide

**Note:** Before using this information and the product that it supports, be sure to read the general information under Appendix A, "Warranties and Notices" on page 123.

### **First Edition (August, 1999)**

**The following paragraph does not apply to any state or country where such provisions are inconsistent with local law:** INTERNATIONAL BUSINESS MACHINES CORPORATION PROVIDES THIS PUBLICATION "AS IS" WITHOUT WARRANTY OF ANY KIND, EITHER EXPRESS OR IMPLIED, INCLUDING, BUT NOT LIMITED TO, THE IMPLIED WARRANTIES OF MERCHANTABILITY OR FITNESS FOR A PARTICULAR PURPOSE. References to IBM products, programs, or services do not imply that IBM intends to make them available outside the United States.

This publication includes information that supports multiple models; therefore not all text may apply to your model. This publication could contain technical inaccuracies or typographical errors. Changes are periodically made to the information herein; these changes will be made in later editions. IBM may make improvements and/or changes in the product(s) and/or program(s) at any time.

Requests for copies of this publication and for technical information about IBM products should be made to your IBM Authorised Dealer, your IBM Marketing Representative or your IBM Retailer. Address comments about this publication to the IBM HelpCenter.

**© Copyright International Business Machines Corporation 1999. All rights reserved.**

Note to U.S. Government Users – Documentation related to restricted rights – Use, duplication or disclosure is subject to restrictions set forth in GSA ADP Schedule Contract with IBM Corp.

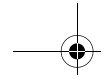

# Table of Contents

1	<b>Safety Notices</b>
3	Conventions used in this book
5	Safety information
8	Consignes de sécurité
13	<b>Ergonomics</b>
15	Arranging a comfortable and productive work area
19	<b>Using your Aptiva PC</b>
21	Hardware
24	Aptiva Help and Software
29	<b>Troubleshooting</b>
31	Diagnosing and recovering from problems
33	Quick step guide
34	Some simple questions to ask first...
39	Solving hardware problems
49	Solving software problems
53	Solving monitor problems
56	Solving audio, multimedia, and modem problems
60	Solving DVD problems
61	Responding to error codes
71	Recovering factory installed programs and files
72	Reinstalling device drivers
75	<b>Setup Utility</b>
77	Using the Setup Utility
85	<b>HelpWare Support and Services</b>
87	What do I do first?

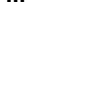
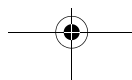
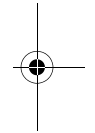
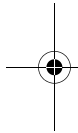

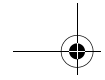

89	How do I get help electronically?
92	How and when do I contact the IBM PC HelpCenter?
98	How and when do I purchase additional support?
102	International Warranty Service - Not Available
103	<b>Adding and removing hardware</b>
105	Preparing to work with the computer
106	Removing and replacing the cover
109	Adding and removing drives
113	Adding and removing adapter cards
116	Identifying system board components
117	Upgrading the system memory
120	Replacing the system battery
123	<b>Warranties and Notices</b>
125	Warranty statements
142	Notices
149	<b>Index</b>

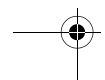
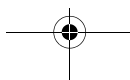
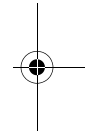
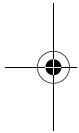



# Chapter 1

## Safety Notices

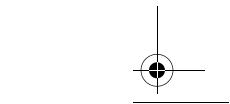
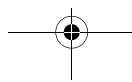
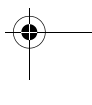
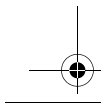
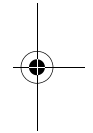
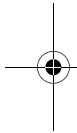
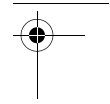
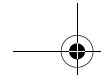
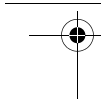





# Safety Notices

---

## Conventions used in this book

### Symbols

The following list contains an explanation of the symbols used in this document.

Symbol	Explanation
 <b>Note</b>	This symbol is used when there is information you might find especially useful. The information may also warn you about possible problems you could encounter.
 <b>Attention</b>	This symbol is used when there is important information that can help you avoid damage to the hardware or software that came with your computer.
 <b>Caution!</b>	This symbol is used when there is important information that can help you avoid potential injury.
 <b>Danger!</b>	This symbol is used when there is important information which can help you avoid the risk of serious personal injury or death.

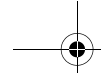

## Highlighting

There are several ways that text is highlighted in this book. Each highlighting convention has a specific purpose.

Highlight	Purpose
<b>Bold</b>	Bold font is used to identify keys on the keyboard or items on the screen you are instructed to click or double-click. Bold font is also used in headings, table titles, and numbered lists.
Example	Example font is used to show text that you need to type from your keyboard.
<i>Italic</i>	Italic font is used to show proper names of programs or books. Italic font is also used in table footnotes and sidenotes.
"Quotes"	Quotation marks are used to identify window, screen, and heading names.
<u>Underline</u>	Underline font is used to call special emphasis to a particular word or instruction.

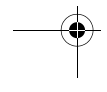
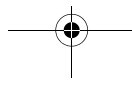
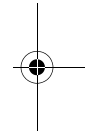
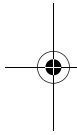

# Safety Notices

---

## Safety information

### Installation

The construction of the IBM Aptiva Personal Computer provides extra protection against the risk of electrical shock. The IBM Aptiva PC has a power cord with a three-prong plug that is required to ground metal parts. It is the responsibility of the person installing the computer to connect it to a properly grounded electrical outlet. Seek professional assistance before using an adapter or extension cord; these devices could interrupt the grounding circuit.

If the computer is connected to an electrical outlet that is incorrectly connected to the building wiring, serious electrical shock could result.

**Continued protection against electrical shock .** For continued protection against the risk of electrical shock, follow these steps:

- Connect your computer only to an electrical outlet of the correct voltage. If you are unsure about the voltage of the electrical outlet you are using, contact your local power company.
- If your computer has cables other than the power cords, you must connect them before plugging the power cords into an electrical outlet. Before removing these cables, you must first unplug the power cords from the outlet.
- If your computer has a telephone connection, do not touch the telephone cords when there is lightning in the area.
- Do not use or store the computer in an area where it can become wet.

- Make sure all replacement parts have characteristics identical or equivalent to the original parts. Other parts may not have the same safety features.
- Personal injury or electrical shock may result if you undertake actions other than those specifically described in this book. This is particularly true if you try to service or repair the power supply, monitor, or built-in modem. Always refer service or repairs to qualified service personnel.



### Caution!

*Your computer uses lithium batteries. There may be a risk of fire, explosion, or burns if the batteries are handled incorrectly. To ensure safety:*

*Do not recharge, disassemble, heat, or incinerate a lithium battery.*

*Replace the battery with an identical or equivalent type lithium battery.*

*Do not throw or immerse the battery into the water.*

*Discard used lithium batteries according to local country dispositions.*

### Safety while working with hardware

Each time you open your computer, you must follow specific safety procedures to ensure that you do not damage your computer. For your safety, and the safety of your equipment, follow the steps for "Disconnecting your computer" on page 7 before you remove the cover of the system unit (if included with the model you purchased).

**Connecting your computer.** To connect your computer:

- 1** Turn off the computer and any external devices (such as a monitor or printer) that have their own power switches.
- 2** Attach a signal cable to each external device (such as a monitor or printer), and then connect the other end of the signal cable to the computer.
- 3** Attach communication cables (such as modem cables or network cables) to the computer. Then, attach the other ends of the cables to properly wired communication outlets.
- 4** Attach the power cords to the computer and any external devices (such as a monitor or printer), and then connect the other ends of the power cords to properly grounded electrical outlets.

# Safety Notices



## Danger!

*To avoid shock hazard:*

*Do not connect or disconnect any cables or perform installation, maintenance, or reconfiguration of this product during an electrical storm.*

*The power cord must be connected to a properly wired and grounded receptacle.*

*Any equipment to which this product will be attached must also be connected to properly wired electrical outlets.*

*Electrical current from power, telephone, and communications cables is hazardous. To avoid shock hazard, use the steps described in this section to connect and disconnect cables when installing, moving, or opening the cover of this product.*

- 5 Turn on the computer and any attached devices that have their own power switches.

**Disconnecting your computer.** To disconnect your computer:

- 1 Turn off the computer and any attached devices that have their own power switches.
- 2 Unplug all power cables from electrical outlets.
- 3 Disconnect all communication cables (such as modem or network cables) from communication outlets.
- 4 Disconnect all cables and cords from the computer; this includes power cords, signal cables from external devices, communication cables, and any other cables attached to the computer.

## Regulatory safety notice for the CD-ROM and DVD-ROM drive

This notice contains required safety information about the CD-ROM/DVD-ROM drive in your computer (if included with the model you purchased). The CD-ROM/DVD-ROM drive is a Class 1 laser product, and Class 1 laser products are not considered to be hazardous. The design of the laser system and CD-ROM/DVD-ROM drive ensures that during normal operation, there is no exposure to laser radiation above Class 1 level.

Please note that the CD-ROM/DVD-ROM drive does not contain any user adjustable or serviceable parts. Service on this drive should only be performed by a trained service provider.

**Laser compliance statement.** Some IBM Personal Computer models are equipped from the factory with a CD-ROM or DVD-ROM drive. CD-ROM/DVD-ROM drives are also sold separately as options. The CD-ROM/DVD-ROM drive is a laser product. The CD-ROM/

DVD-ROM drive is certified in the U.S. to conform to the requirements of the Department of Health and Human Services 21 Code of Federal Regulations (DHHS 21 CFR) Subchapter J for Class 1 laser products. Elsewhere, the drive is certified to conform to the requirements of the International Electrotechnical Commission (IEC) 825 and CENELEC EN 60 825 for Class 1 laser products.

When a CD-ROM/DVD-ROM drive is installed, note the following:



**Caution!**

**Caution!** Use of controls or adjustments or performance of procedures other than those specified herein might result in hazardous radiation exposure.

Removing the covers of the CD-ROM/DVD-ROM drive could result in exposure to hazardous laser radiation. There are no serviceable parts inside the CD-ROM/DVD-ROM drive. Do not remove the CD-ROM/DVD-ROM drive covers.

Some CD-ROM/DVD-ROM drives contain an embedded Class 3A or Class 3B laser diode. Note the following:



**Danger!**

**Danger!**

Laser radiation when open. Do not stare into the beam, do not view directly with optical instruments, and avoid direct exposure to the beam.

---

## Consignes de sécurité

### Installation

La conception de fabrication de l'ordinateur personnel Aptiva IBM assure une protection accrue contre les risques d'électrocution. Le PC Aptiva IBM possède un



# Safety Notices

cordon d'alimentation équipé d'une fiche à trois broches qui permet une mise à la terre des principaux éléments métalliques de la machine. Il incombe au responsable de l'installation de vérifier le branchement. Si vous devez installer un adaptateur ou une rallonge, faites appel à un professionnel pour ne pas risquer de créer une rupture dans le circuit de mise à la terre.

Un socle de prise de courant incorrectement relié à l'alimentation électrique du bâtiment peut être à l'origine d'une électrocution.

**Protection contre les risques d'électrocution .** Pour vous prémunir contre les risques d'électrocution, respectez les consignes ci-après :

- Ne branchez l'ordinateur que sur un socle de prise de courant présentant la tension adéquate.
- Ne branchez le cordon d'alimentation sur le socle de prise de courant qu'après avoir connecté tout autre cordon à la machine. Inversement, débranchez le cordon d'alimentation du socle de la prise de courant avant de déconnecter tout autre cordon.
- Si votre ordinateur est doté d'un cordon téléphonique, ne manipulez jamais ce cordon pendant un orage.
- Évitez d'utiliser et de placer votre ordinateur dans un endroit humide.
- Ne remplacez un élément que par un élément identique ou possédant des caractéristiques équivalentes et équipé des mêmes dispositifs de sécurité.
- Le non-respect de ces consignes peut être à l'origine de blessures ou d'une électrocution, en particulier si vous intervenez sur le bloc d'alimentation, l'écran ou le modem intégré. Confiez la maintenance et la réparation de l'ordinateur à une personne qualifiée.

## Consignes de sécurité lors de la manipulation du matériel



### Attention!

*Votre ordinateur est équipé de piles au lithium.*

*Prenez garde aux risques d'incendie, d'explosion ou de brûlures liés à une mauvaise utilisation des piles. Respectez les consignes de sécurité suivantes:*

*Ne rechargez pas la pile, ne la démontez pas, ne l'exposez pas à la chaleur et ne la faites pas brûler.*

*Ne la remplacez que par une pile identique ou de type équivalent.*

*Ne la jetez pas à l'eau.*

*Pour le recyclage ou la mise au rebut des piles au lithium, reportez-vous à la réglementation en vigueur.*

Lorsque vous ouvrez l'unité centrale, il convient de suivre un certain nombre de consignes de sécurité afin de ne pas endommager l'ordinateur. Pour votre sécurité et celle de votre matériel, suivez les instructions de la section "Disconnecting your computer" on page 7, avant d'ouvrir l'unité centrale (le cas échéant).

**Branchement de l'ordinateur.** Pour brancher l'ordinateur, procédez comme suit :

- 1** Mettez l'ordinateur hors tension ainsi que tout périphérique (écran ou imprimante) que vous allez connecter, qui dispose d'un interrupteur d'alimentation.
- 2** Connectez tous les câbles (de l'écran, par exemple) à l'ordinateur.
- 3** Branchez tous les câbles d'interface (par exemple, un câble téléphonique) sur des socles de prise de courant correctement mis à la terre.
- 4** Branchez les cordons d'alimentation sur des socles de prise de courant correctement mis à la terre.
- 5** Mettez l'ordinateur sous tension ainsi que tout périphérique connecté disposant d'un interrupteur d'alimentation.

**Débranchement de l'ordinateur.** Pour débrancher l'ordinateur, procédez comme suit :

- 1** Mettez l'ordinateur hors tension ainsi que tout périphérique connecté disposant d'un interrupteur d'alimentation.
- 2** Débranchez tous les cordons d'alimentation des prises de courant.
- 3** Débranchez tous les câbles (câble de téléphone, par exemple) de leurs prises.

# Safety Notices



## **Danger!**

*Pour éviter tout risque de choc électrique :*

*Ne manipulez aucun cordon et n'effectuez aucune opération d'installation, de maintenance ou reconfiguration de ce produit au cours d'un orage.*

*Les cordons d'alimentation du présent produit et de tous les appareils qui lui sont connectés doivent être branchés sur des socles de prise de courant correctement câblés et mis à la terre.*

*Le courant électrique circulant dans les câbles de communication et les cordons téléphoniques et d'alimentation est dangereux. Pour éviter tout risque de choc électrique, respectez les consignes de la présente section pour connecter et déconnecter des câbles lors de l'installation, du retrait ou de l'ouverture du panneau de ce produit.*

- 4 Débranchez tous les câbles de l'ordinateur (les cordons d'alimentation, les câbles d'entrée-sortie et tous les autres câbles qui pourraient y être connectés).

## **Consignes de sécurité pour l'unité et CD-ROM et de DVD-ROM**

La présente consigne contient les informations de sécurité relatives à l'unité de CD-ROM/DVD-ROM de votre ordinateur (le cas échéant). L'unité de CD-ROM/DVD-ROM est un produit à laser de classe 1. Les produits de classe 1 ne sont pas considérés comme dangereux. Le système à laser et l'unité de CD-ROM/DVD-ROM ont été conçus de façon telle qu'il n'existe aucun risque d'exposition à un rayonnement laser de niveau supérieur à la classe 1 dans des conditions normales d'utilisation.

Veillez noter qu'aucune pièce de l'unité de CD-ROM/DVD-ROM n'est réglable ni réparable. Ne confiez la réparation de cette unité qu'à une personne qualifiée.

### **Conformité aux normes relatives aux appareils laser.**

Certains modèles d'ordinateurs personnels sont équipés d'origine d'une unité de CD-ROM ou de DVD-ROM. Mais ces unités sont également vendues séparément en tant qu'options. L'unité de CD-ROM/DVD-ROM est un appareil à laser. Aux Etats-Unis, l'unité de CD-ROM/DVD-ROM est certifiée conforme aux normes indiquées dans le sous-chapitre J du DHHS 21 CFR relatif aux produits à laser de classe 1. Dans les autres pays, elle est certifiée être un produit à laser de classe 1 conforme aux normes CEI 825 et CENELEC EN 60 825.

Lorsqu'une unité de CD-ROM/DVD-ROM est installée, tenez compte des remarques suivantes :



**Attention!**

**Attention !** Pour éviter tout risque d'exposition au rayon laser, respectez les consignes de réglage et d'utilisation des commandes, ainsi que les procédures décrites.

L'ouverture de l'unité de CD-ROM/DVD-ROM peut entraîner un risque d'exposition au rayon laser. Pour toute intervention, faites appel à du personnel qualifié.

Certaines unités de CD-ROM/DVD-ROM peuvent contenir une diode à laser de classe 3A ou 3B. Tenez compte de la consigne qui suit :



**Danger!**

**Danger !**

Rayonnement laser lorsque le carter est ouvert. Evitez toute exposition directe des yeux au rayon laser. Evitez de regarder fixement le faisceau ou de l'observer à l'aide d'instruments optiques.

# Chapter 2

## Ergonomics

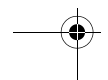
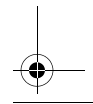
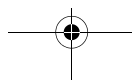
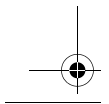
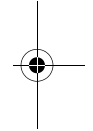
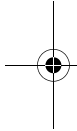
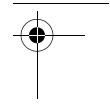
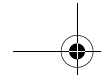
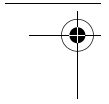

# Ergonomics

## Arranging a comfortable and productive work area



### Note

*The computer you purchased may have components which are different from those shown here.*

### Arranging your work area

When you arrange your computer, position your monitor and keyboard directly in front of you. Place the mouse close to the keyboard so that you can use it without stretching or leaning over to one side.

The system unit is usually kept on the floor under or beside your desk. Be sure to place it in an area that will not block the space you need to put your legs under the work surface.

Organize your desk to reflect the way you use work materials and equipment. Place the things that you use most regularly, such as a mouse or telephone, within the easiest reach.

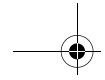

## Choosing a chair

You should adjust your chair so that your thighs are horizontal and there is support for your lower back. Your feet should rest flat on the floor or a foot rest when you are seated and using your keyboard.

## Positioning the monitor

- Place the monitor at a comfortable viewing distance. You can also use the length of your arm to determine a comfortable viewing distance.
- Adjust your monitor so the top of the screen is at, or slightly below, eye level.
- Keep the screen clean. For cleaning instructions, refer to the documentation that came with your monitor.
- If you place the monitor near a window, consider using curtains or blinds to minimize glare from sunlight. Also be sure to keep the monitor perpendicular to the windows to reduce glare when the curtains or blinds are open. Try to avoid placing the monitor directly in front of a window.
- Use dim room lighting. If you need more light on your work, you should position the light so it shines on your work surface but not onto the monitor screen.
- Use the monitor controls to adjust the screen's brightness and contrast levels to a comfortable level. You may have to do this more than once a day if the light in the room changes. For monitor control adjustment instructions, refer to the documentation that came with your monitor.
- When your eyes focus on a specific object for a long period of time, they may become tired. If you spend a lot of time looking at your screen, remember to take

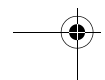
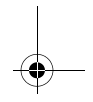
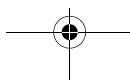
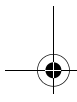
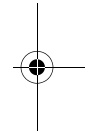
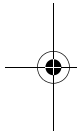



# Ergonomics

frequent breaks. Look up periodically and focus on an object that is further away. This will give the muscles in your eyes a chance to relax.

## Positioning the keyboard

- Make sure the keyboard height is comfortable for typing.
- When you type, the keyboard should be positioned so that your arms are relaxed and comfortable, and your forearms are roughly horizontal. Your shoulders should be relaxed and not hunched up.
- Type with a light touch, keeping your hands and fingers relaxed. Your wrists should also be straight.
- If your computer came with a wristrest and you choose to use it, do not rest your hands on the wristrest or desktop while you are typing. Instead, use the wristrest only when resting. If you prefer not to use the wristrest, you may remove it and use the keyboard without it.

## Positioning the mouse

- Position your mouse on the same surface as your keyboard so that they are at the same level. Allow enough space so that you can use your mouse without stretching or leaning over.
- When you use the mouse, hold it lightly with all your fingers and click gently. Move the mouse with your entire arm instead of only using your wrist.

For more detailed information and tips about how to use your computer, refer to the tutorials on your computer or visit the IBM Healthy Computing Web site at <http://www.pc.ibm.com/us/healthycomputing>

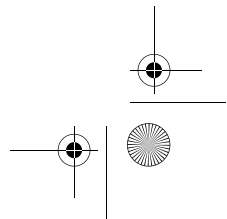
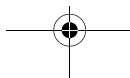
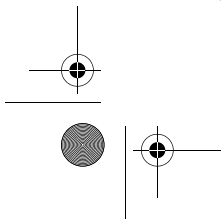
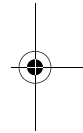
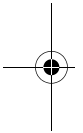
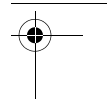
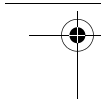
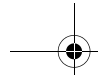

# Chapter 3

## Using your Aptiva PC

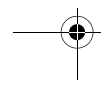
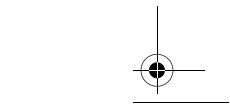
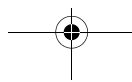
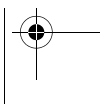
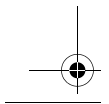
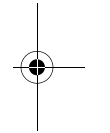
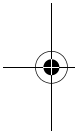
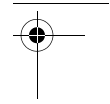
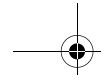
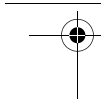

# Using your Aptiva PC

This chapter contains basic information on how to use some of the hardware and software features of your computer.

---

## Hardware

### Using the Rapid Access™ II keyboard

The Rapid Access keyboard contains some buttons and controls that might be new to you.

Rapid Access Buttons are shortcut buttons on the keyboard that start a program, open a file, browse a Web page, or perform a specific function when you press them. These keys allow you to go straight to a file, program, or Internet address with the press of a button instead of having to click on an icon, search for the program in the Start menu, or type an Internet address in your browser.

Some of the Rapid Access Buttons are preset to support important functions on your computer (Mute, Volume, and the CD/DVD controls); these cannot be changed.

There are seven Rapid Access Buttons across the top of the keyboard. The preset functions are printed on the label above the buttons. You can customize five of the buttons to start any program or Web page. For example, if you enjoy playing Solitaire, you can customize a Rapid Access Button to open the Solitaire program. The Help and Standby buttons have preset functions that you cannot customize. Press the Help button to start the Aptiva Help system. Press the Standby button to put your computer in suspend mode to save power while the computer is temporarily not in use. The Standby button lights up while the computer is in suspend mode. To exit from the suspend mode, press the computer power switch.

### To customize a Rapid Access Button.

- 1 From the Windows desktop, click **Start**.
- 2 Select **Settings**, and then click **Control Panel**.
- 3 Double-click **Keyboard (Rapid Access)**. The Rapid Access Keyboard Customization program starts.
- 4 Follow the instructions on the screen.

To learn more about the Rapid Access keyboard, click **Help** on any of the Rapid Access Keyboard Customization screens.

### Using the IBM ScrollPoint™ II mouse

The ScrollPoint II mouse has the following controls:

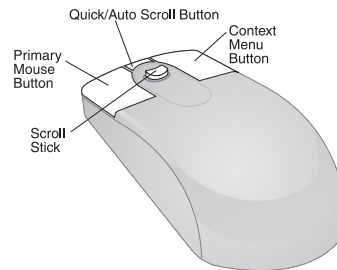

*Primary mouse button.* Use this button to select or start a program or menu item.

*Quick/Auto scroll button.* Use this button to put the mouse into auto-scroll mode. When the mouse is in auto-scroll mode, the movement of the mouse controls the scrolling direction and speed. To exit from the auto-scroll mode, click any of the mouse buttons.

*Context menu button.* Use this button to access a context menu for an active program, icon, or object.

# Using your Aptiva PC

*Scroll stick.* Use this stick to control the scrolling action of the mouse. This stick is pressure sensitive. The direction in which you apply pressure controls the direction of the scrolling action. The amount of pressure you apply controls the scrolling speed.

To customize the behavior of the mouse buttons, change pointers, or modify other mouse features to meet your individual needs, do the following:

- From the Windows desktop, click **Start**.
- Select **Settings**, and then click **Control Panel**.
- Double-click **Mouse**. The Mouse Properties window opens.
- Click on the applicable tab and follow the instructions on the screen.

To learn more about the ScrollPoint II mouse, click **Help** on any of the Mouse Properties screens.

## Handling discs

The computer you purchased came with either a Compact Disc (CD) or Digital Versatile Disc (DVD) drive. To insert a CD or DVD into the drive:

- 1** Open the loading tray by pressing the **Eject** button on the drive.
- 2** Remove the disc from the sleeve or case.
- 3** Place the disc into the circular recess of the tray. Make sure that the label on the disc is facing up. Some DVDs are recorded on both sides of the disc.



### Attention

*If your drive tray has clips, make sure they are retracted before you insert a disc.*

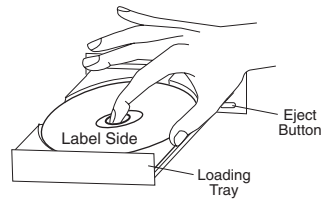

- 4 Close the loading tray by pressing the **Eject** button. You can also push gently on the front of the tray until it begins to retract.

---

## Aptiva Help and Software

Your computer came with several types of information and software. This chapter includes information about:

- Aptiva How Do I... cue cards
- Aptiva Help
- Readme files
- Software installed on CD or DVD

### Aptiva How Do I... cue cards

How Do I...? gives you direct access to some of the most popular programs and tools available with your Aptiva PC. Let the cue cards help you register your computer, set up a printer, play an audio CD, and complete several other common tasks. You can find How Do I... through Access Aptiva on your Aptiva desktop.



# Using your Aptiva PC

## Aptiva Help

Your computer came with Aptiva-specific help information located on the hard disk drive. You can find these help topics in Aptiva Help through the Start menu or by pressing the Help button on your Rapid Access keyboard.

### To start Aptiva Help.

- 1 Start **Access Aptiva** (if it's not already started).
- 2 Click **Get Help**.
- 3 Click **Aptiva Help Files**.

You also can access Aptiva Help through the **Start** menu or by pressing the **Help** button on your Rapid Access keyboard.

Aptiva Help contains information and instructions for many tasks including:

- Arranging the workplace
- Registering the Aptiva PC
- Adjusting sound and display settings
- Setting up a modem
- Using the computer
- Connecting to the Internet
- Sending e-mail
- Maintaining the computer
- Updating software
- Recovering from problems

If you need more information about your computer, Aptiva Help also includes information about:

- Aptiva Help
- Year 2000

- Access Aptiva
- The Internet
- DVD
- Computer care
- Computer configuration
- Software programs
- Support

**To reinstall Aptiva Help.** If you uninstall Aptiva Help and want to reinstall it, do the following:

- 1 Make sure the computer is turned on.
- 2 Insert the "Product Recovery and Diagnostics CD-ROM" into the CD-ROM or DVD-ROM drive.
- 3 From the Start menu, click **Run**.
- 4 Type the following command:  
G:\Applications\Helps\Setup.exe
- 5 Click **OK** and follow the instructions on the screen.

### Readme files

Another type of online information is available in README.TXT files. These files usually come with programs and contain information about additional features. README.TXT files also may contain instructions about setting up the program to run most efficiently.

If the Aptiva Readme file is provided, the file is named APTIVA.TXT. You can locate the Aptiva Readme in Access Aptiva.

# Using your Aptiva PC

## Installing programs

Some programs might have been provided with your computer either on CD-ROM, DVD-ROM, or preinstalled on your hard disk. The titles vary by model and by country or region. To locate the programs installed on your hard disk, do the following:

- 1 From the Windows desktop, click **Start**.
- 2 Select **Programs**. You see a listing of programs and folders containing programs.

Some entertainment programs that may have come with your computer may contain language not suitable for children. The Entertainment Software Review Board (ESRB), has reviewed many software programs and maintains a list of program titles and ratings. To find a rating for a program, contact the ESRB Web site at <http://www.esrb.org>.

PROGRAMS MAY VARY FROM RETAIL VERSIONS AND MAY NOT INCLUDE ALL DOCUMENTATION OR FUNCTIONS.



### Note

*In some cases, the hard disk drive in the model you purchased may not be large enough to complete a full install of each program. In these cases, use the “partial install” option if you want to install all of the programs to the same hard disk drive.*

### Using and installing software with the AutoPlay feature.

Most discs are “AutoPlay enabled”. If the AutoPlay feature of Windows is enabled, it will automatically start the installation program (or the first song of a music CD) when you insert a disc in the drive. For more information about AutoPlay, refer to the Microsoft Windows help system.

Some programs install on your hard disk drive, but also require a CD or DVD to be in the drive before the program will start. If the program is already installed and you insert the disc, the AutoPlay feature will start the program automatically.

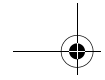

If your Aptiva computer has a DVD-ROM drive, the AutoPlay feature will always start AutoPlay-enabled CDs or DVDs. If there are no AutoPlay-enabled programs on a DVD video disc, the AutoPlay feature will start the DVD video.

### Updating programs

**IBM Update Connector program.** You can use the IBM Update Connector program to look for available updates for the software that came from the factory with your computer. For information about the IBM Update Connector, see Aptiva Help. For information about Aptiva Help, see "Aptiva Help" on page 25.

**Norton AntiVirus program.** If you have Norton Antivirus installed, you can update the Norton AntiVirus program using the Norton Live Update program. This program will automatically apply available updates to the Norton AntiVirus program.

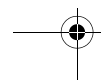
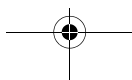
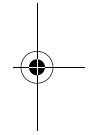
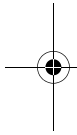

# Chapter 4

## Troubleshooting

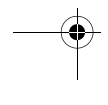
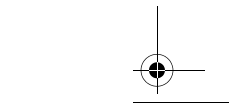
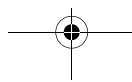
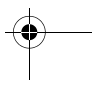
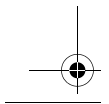
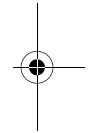
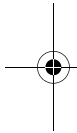
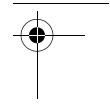
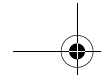
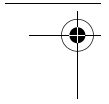

# Troubleshooting

---

## Diagnosing and recovering from problems

This chapter contains information that can help you solve common problems that you might have with your computer.

You should look through this chapter to find the problem description or error code that matches the problem you are having. When you find the description, simply follow the steps to solve the problem. Some problems have multiple steps. You should follow the steps until the problem is solved. A problem description may contain steps which you may not be required to follow.

The information contained in this chapter is intended for several models of the Aptiva Personal Computer. The computer you purchased may not have some of the hardware discussed in these sections.

If your computer did not come with the hardware described, some of the troubleshooting information may not apply. For example, if the model you purchased did not contain a Rapid Access keyboard, instructions about the Rapid Access keyboard will not apply. Follow the steps for the hardware that came with your computer.

If you follow the steps in this chapter and the problem continues, you can still get help. See "HelpWare Support and Services" on page 85 for more information about contacting IBM.

To run the diagnostics programs, do the following:

- 1 Insert the "Product Recovery and Diagnostics CD-ROM" in the CD drive.
- 2 Shut down the operating system and turn off your computer. Wait for the power light to turn off.
- 3 Turn on your computer.

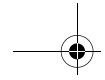

- 4 When you see the Main Menu, use the arrow keys to select **System Utilities**.
- 5 On the System Utilities menu, select **Run Diagnostics**.
- 6 From the menu bar, select **Diagnostics** and select **Run Normal Test**.

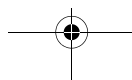
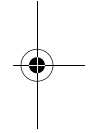
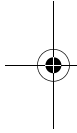



# Troubleshooting

## Quick step guide

If you think you have a problem with your computer, you can use the following quick step guide to determine the nature of the problem.

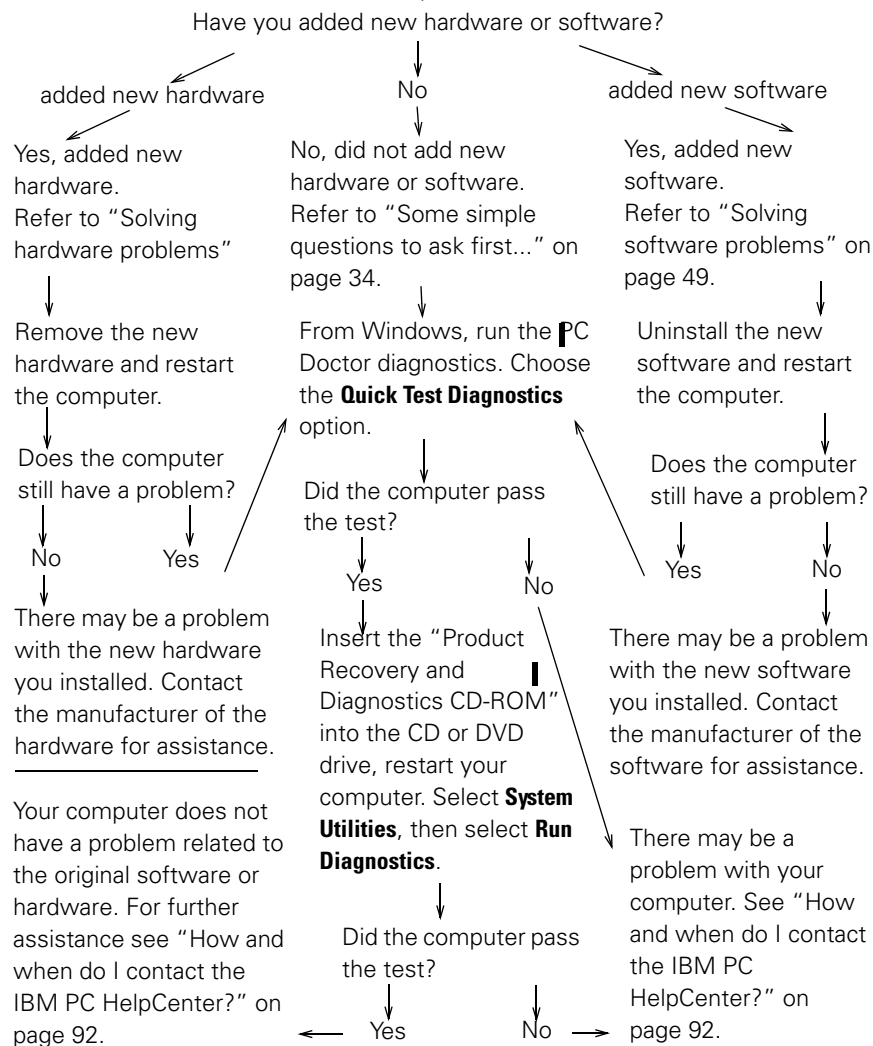

---

## Some simple questions to ask first...

### Are both the computer and monitor power lights lit?

---

**Yes** Power is reaching the system and monitor. See "Did the system beep after it was turned on?" on page 35.

**No**

- 1 Press the On/Off buttons on the computer and monitor to make sure they are turned on.
- 2 Make sure the power switch that is attached to the power supply at the back of the system unit is pressed in the on position ("1" is on, "0" is off). This power switch may not be available for all computers.
- 3 Make sure the system unit and monitor cables are correctly and securely connected. Make sure the system unit and monitor power cords are plugged into electrical outlets. The *Setup Poster* shows how the cables and cords should be connected.
- 4 Make sure the electrical outlets you are using are not controlled by a wall or dimmer switch.  
If you are using a multiple outlet device (for example, a power surge protector or power strip), make sure it is plugged in and turned on.



*If any of these problems continue after taking the actions listed, run the diagnostics programs that came with your computer. If you need service, see "HelpWare Support and Services" on page 85.*

---

# Troubleshooting

## Did the system beep after it was turned on?

---

### Yes

There may be a hardware problem.

- If you added hardware, remove it and restart the computer to see if the problem is corrected. If the problem is corrected, you may not have installed your hardware correctly. Reinstall your hardware. For instructions on installing hardware in the system unit, see Chapter 7, "Adding and removing hardware." If the problem is not corrected, see "Solving hardware problems" on page 39.
- Make sure that the system memory modules are properly installed. If the memory is not installed correctly, the system will beep several times (in a 2 long beeps - 3 short beeps sequence). Reinstall the memory modules. If you hear a beep sequence other than the 2 long-3 short beeps, or if the memory modules are installed correctly, see "HelpWare Support and Services" on page 85 for information on obtaining service.
- If you have not added hardware, see "HelpWare Support and Services" on page 85 for information on obtaining service.

### Yes, more than once

There is a problem with the system unit. Find the error code or message in the section "Responding to error codes" on page 61.

### No

The system has passed the Power-On Self-Test (POST).



*If any of these problems continue after taking the actions listed, run the diagnostics programs that came with your computer. If you need service, see "HelpWare Support and Services" on page 85.*

*Some simple questions to ask first...*

**35**

### Is anything unusual displayed on the monitor?

---

#### Yes

There may be a problem with the system unit if:

- An error message appears. Find the error message in the section “Responding to error codes” on page 61 and take the action listed.
- A line containing an error code and message appears. Follow the instructions in the message. For instructions on using the Setup Utility, see “Using the Setup Utility” on page 77.
- A blinking cursor appears. See “HelpWare Support and Services” on page 85 for information on obtaining service.
- The image on the screen is unreadable (the image is scrolling, blinking, or flashing). You may have selected a monitor setting that your monitor does not support. Follow these steps to reconfigure your monitor:
  - a. Restart the computer. If necessary, turn off the system unit, pause for 15 seconds, and then turn the system back on.
  - b. When you see “Starting Windows” appear on the screen during startup, press **F8**. This opens the Microsoft Windows 98 Startup Menu.
  - c. Select Choice 3 for Safe Mode and press **Enter**. This starts your computer using the Windows factory configuration settings.
  - d. When your computer has completed startup, double-click the **My Computer** desktop icon.



*If any of these problems continue after taking the actions listed, run the diagnostics programs that came with your computer. If you need service, see “HelpWare Support and Services” on page 85.*

# Troubleshooting

## Is anything unusual displayed on the monitor?

---

- e. In the My Computer window, double-click the **Control Panel** icon.
  - f. In the Control Panel window, double-click the **Display** icon.
  - g. In the Display Properties window,
    - i. Click the **Settings** tab.
    - ii. Click the **Advanced...** button.
    - iii. Click the **Monitor** tab.
    - iv. Click the **Change...** button.
  - h. Choose a new monitor setting. If you need additional help, refer to the operating system help files or the instructions that came with the monitor.
  - i. Restart the computer again. Your computer may take a little longer than usual to restart.
- The colors displayed are wrong.
    - Make sure the monitor cable is correctly and securely connected to the system unit. The *Setup Poster* shows how the cable should be connected.
    - You may need to DeGauss your monitor. If the monitor you purchased came with a manual DeGauss feature, check the documentation that came with the monitor for information on how to use this feature.



*If any of these problems continue after taking the actions listed, run the diagnostics programs that came with your computer. If you need service, see "HelpWare Support and Services" on page 85.*

### Is anything unusual displayed on the monitor?

---

#### Yes

- There may be a problem with the monitor.
  - a. Make sure your monitor cables are correctly and securely connected. The *Setup Poster* shows how the cables should be connected.
  - b. Adjust the brightness and contrast controls on the monitor. For instructions, refer to the documentation that came with your monitor.
- If you have added a video adapter card, make sure that:
  - a. the monitor cable is properly connected to the new video adapter card and
  - b. the BIOS is configured to use the adapter card as the primary video adapter. For information on using the Setup Utility, to view or modify BIOS settings, see "Starting the Setup Utility" on page 78.
- There may be a problem with the battery on your system board. For instructions on how to replace the battery, see Chapter 7, "Adding and removing hardware."



*If any of these problems continue after taking the actions listed, run the diagnostics programs that came with your computer. If you need service, see "HelpWare Support and Services" on page 85.*

---

# Troubleshooting

## Solving hardware problems

If the problem is...	Here's what to do...
<b>Beep during Power-On Self-Test (POST)</b>	See the troubleshooting steps in the section titled "Did the system beep after it was turned on?" on page 35.
<b>Screen is black (no error code)</b>	If you <u>did not install memory modules or adapter cards</u> , see "HelpWare Support and Services" on page 85 for information on obtaining service.
<b>Error code is displayed</b>	If an error code is displayed, find the code in "Responding to error codes" on page 61 and take the action listed.
<b>Computer appears to have turned off without warning</b>	<ol style="list-style-type: none"> <li><b>1</b> If the Standby feature is enabled, press the On/Off button on the front of the system unit.</li> <li><b>2</b> Make sure that the system unit and monitor power cords are securely plugged into electrical outlets.</li> <li><b>3</b> Make sure that the cables are correctly and securely connected to the system unit.</li> <li><b>4</b> Check for a blown fuse, tripped circuit breaker, or power failure.</li> <li><b>5</b> Unplug the system power cord from the electrical outlet, wait 15 seconds, and then plug the power cord back into the electrical outlet. If the computer does not start immediately, push the system On/Off button.</li> <li><b>6</b> If you have added hardware inside the system unit, make sure that the power cable connectors are securely attached.</li> </ol>
	<p><i>If any of these problems continue after taking the actions listed, run the diagnostics programs that came with your computer. If you need service, see "HelpWare Support and Services" on page 85.</i></p>

**If the problem is...****Here's what to do...****Can't enter password**

- 1 Make sure that the keyboard is on. During the Power-On Self-Test (POST), the keyboard lights will flash and the Num Lock light will remain on during and after the Power-On Self-Test (POST).
- 2 Make sure that you typed the correct password.
- 3 Make sure the keyboard cable is correctly and securely connected to the keyboard port (not the mouse port) on the back of the system unit. The keyboard port has a purple label and this symbol next to it: 

**Can't read information on diskette, CD, DVD or Zip Disks**

- 1 Make sure you are using the correct type of diskette and that it is formatted correctly.
- 2 Make sure the diskette, CD, DVD or Zip disk is inserted into the drive correctly.
- 3 Make sure the CD is clean and not scratched.
- 4 Try to use a diskette, CD, DVD or Zip disk that you know is good. If it works, the first diskette, CD, DVD or Zip disk may be damaged. If you can't read the information on the good diskette, CD, DVD or Zip disk, there may be a problem with your drive.
- 5 Make sure the power and signal cables are securely attached to the back of the drive. For instructions on working with drives, see Chapter 7, "Adding and removing hardware."
- 6 Make sure the correct diskette drive is selected and the diskette drive is enabled in the Setup Utility. For information on using the Setup Utility, see "Starting the Setup Utility" on page 78.



*If any of these problems continue after taking the actions listed, run the diagnostics programs that came with your computer. If you need service, see "HelpWare Support and Services" on page 85.*



# Troubleshooting

## If the problem is...

## Here's what to do...

### Can't send information (write) to diskette or Zip disk

- 1 Make sure you are using the correct type of disk and that it is formatted correctly.
- 2 Make sure the disk is not write-protected.
- 3 Make sure you are sending information to the correct drive.
- 4 Make sure there is space on the disk for the information. (Try using a blank, formatted disk.)
- 5 Try to write to a diskette that you know is good. If it works, the first diskette is damaged. If you can't write the information on the good diskette, there may be a problem with your diskette drive.
- 6 Make sure the power and signal cables are securely attached to the back of the drive. For instructions on working with drives, see Chapter 7, "Adding and removing hardware."
- 7 Make sure the correct diskette drive is selected and the diskette drive is enabled in the Setup Utility. For information on using the Setup Utility, see "Starting the Setup Utility" on page 78.

### Can't format diskette

- 1 Make sure the diskette is not write-protected.
- 2 Make sure you are using the correct type of diskette.
- 3 Make sure the power and signal cables are securely attached to the back of the drive. For instructions on working with drives, see Chapter 7, "Adding and removing hardware."
- 4 Make sure the correct diskette drive is selected and the diskette drive controller is enabled in the Setup Utility. For information on using the Setup Utility, see "Starting the Setup Utility" on page 78.



*If any of these problems continue after taking the actions listed, run the diagnostics programs that came with your computer. If you need service, see "HelpWare Support and Services" on page 85.*

**If the problem is...**

**Here's what to do...**

**When the computer is turned on, the message "Insert a system diskette and press Enter to reboot" appears**

- 1** Remove any diskette from the diskette drive and restart your computer.
- 2** Restart your computer and use the Setup Utility to make sure that startup devices are set correctly. Make sure the Disk Drive options for the drives you have designated as startup devices are set correctly. For information about starting the Setup Utility, see "Starting the Setup Utility" on page 78.
- 3** Make sure the power and signal cables are securely attached to the back of the hard disk drive in the system unit.
- 4** Insert the "Product Recovery and Diagnostics CD-ROM" into the CD or DVD drive and press **Ctrl + Alt + Delete**. Follow the instructions on the screen to restore the operating system files to your computer's hard disk drive.  
In some cases, this recovery process formats your hard disk drive, erasing all files.
- 5** If you are not able to restore the operating system files to your computer's hard disk drive, see "HelpWare Support and Services" on page 85 for information on obtaining service.



*If any of these problems continue after taking the actions listed, run the diagnostics programs that came with your computer. If you need service, see "HelpWare Support and Services" on page 85.*

# Troubleshooting

## If the problem is...

## Here's what to do...

**Audio disc does not automatically play when inserted into CD or DVD drive**

Make sure you have enabled AutoPlay. To enable AutoPlay, follow these steps:

- 1** From the Windows desktop, double-click the **My Computer** icon.
- 2** In the My Computer window, double-click the **Control Panel** folder.
- 3** In the Control Panel window, double-click the **System** icon.
- 4** In the System Properties window, click the **Device Manager** tab.
- 5** Double-click the **CD-ROM** or **DVD-ROM** list item and then double-click the listed CD-ROM option.
- 6** In the Properties window, click the **Settings** tab.
- 7** Under **Options**, click the **Auto insert notification** check box to add a check to the box.
- 8** Click **OK** to exit the Properties window and save the setting.
- 9** Click **OK** to exit the System Properties window.



*If any of these problems continue after taking the actions listed, run the diagnostics programs that came with your computer. If you need service, see "HelpWare Support and Services" on page 85.*

**If the problem is...****Here's what to do...****All or some keys on the keyboard do not work**

- 1** Make sure the computer and the monitor are turned on.
- 2** Make sure the keyboard cable is securely connected to the keyboard port (not the mouse port) on the back of the computer. The keyboard port has a purple label and this symbol next to it:  .
- 3** Move your fingers across all of the keys. Make sure no keys are stuck.
- 4** If one or more of the Rapid Access Buttons are the only keys that are not working, you might have these buttons disabled or not assigned to a function. Use the help system in the the Rapid Access Customization Keyboard program to help diagnose problems with Rapid Access Buttons. To access the program and start the help system:
  - a. From the Windows desktop, click **Start**.
  - b. Select **Settings**, and then click **Control Panel**.
  - c. Double-click **Keyboard (Rapid Access)**. The Rapid Access Keyboard Customization program starts.
  - d. Click **Help**.
- 5** Make sure you are using a program that allows typing. Some programs do not.
- 6** Turn off the system, wait 15 seconds, and then turn on the system again.  
If you cannot correct the problem, have the computer serviced.



*If any of these problems continue after taking the actions listed, run the diagnostics programs that came with your computer. If you need service, see "HelpWare Support and Services" on page 85.*

# Troubleshooting

## If the problem is...

## Here's what to do...

### Mouse does not move the cursor

- 1** Move the mouse onto a mouse pad (or a similar surface) and try using it.
- 2** Make sure you are using a program that allows the use of a mouse. Some programs do not.
- 3** Make sure the mouse cable is correctly and securely connected to the mouse port (not the keyboard port) on the back of the system unit.  
The mouse port has a green label and this symbol next to it: .
- 4** Turn off the system, wait 15 seconds, and then turn the system on again.
- 5** Clean the mouse. To clean the mouse, follow these steps:
  - a. Turn off the computer.
  - b. Disconnect the mouse cable from the system unit.
  - c. Turn the mouse upside down. Unlock the retainer on the bottom of the mouse by turning it counterclockwise. (On some models, you may have to turn it clockwise instead.) Now turn the mouse right side up, and the retainer and the ball will drop out.
  - d. Using a damp cloth, wipe the outside of the mouse and the retainer. Be sure to wipe the rollers inside the mouse.
  - e. Insert the ball and retainer. Lock the retainer by turning it clockwise. (On some models, you may have to turn it counterclockwise instead.)
  - f. Reconnect the mouse cable to the system unit.
  - g. Turn the computer on.



*If any of these problems continue after taking the actions listed, run the diagnostics programs that came with your computer. If you need service, see "HelpWare Support and Services" on page 85.*

**If the problem is...****Here's what to do...****ScrollPoint II Mouse does not scroll windows**

Make sure the program supports the scrolling mouse. Some programs do not.

**Modem / communications errors**

- 1** Make sure the telephone cord is securely connected. The *Setup Poster* shows how the cord should be connected.
- 2** Make sure the telephone line works by plugging a working telephone into the same telephone outlet that the computer was plugged into. Then make sure you can place a call.
- 3** Make sure you are calling the correct number, and that you are using the correct communications settings. For additional help, refer to the documentation for your communications software.
- 4** Make sure no one is using the telephone while you are communicating with another computer.
- 5** If you have call waiting, make sure it is disabled.
- 6** If some communications programs work but others do not, there may be a configuration problem. For additional help, refer to the documentation for your communications software.
- 7** Make sure your modem cord is connected to an analog telephone line. The local telephone company can help you determine the type of telephone line.
- 8** Make sure the modem adapter card is installed correctly. For instructions on working with adapter cards, see Chapter 7, "Adding and removing hardware."



*If any of these problems continue after taking the actions listed, run the diagnostics programs that came with your computer. If you need service, see "HelpWare Support and Services" on page 85.*

# Troubleshooting

## If the problem is...

## Here's what to do...

### Printer error

- 1** Make sure the printer is turned on.
- 2** Make sure the printer cable is correctly and securely connected to the printer and to the parallel (printer) port on the back of the system unit.  
The parallel port has a burgundy label and this symbol next to it: 
- 3** Make sure the printer power cord is securely connected to an electrical outlet.
- 4** Make sure the printer is ready for printing. (On some printers, if the ready light is on, but not flashing, the printer is ready.)
- 5** If a printer driver is required, make sure the correct printer driver is selected in the software. For instructions on selecting a printer driver, see the online help files that came with the operating system.
- 6** Make sure the paper and the cartridge containing the print material (ink, ribbon, or toner) are loaded correctly.
- 7** Turn off the printer and computer and wait 15 seconds. Then turn on the printer first, followed by the computer.
- 8** If you are printing from Windows, look in the Device Manager to see if any error symbols appear for the port used by the printer. For information on Device Manager, see the online help files that came with the operating system.
- 9** If you are printing from DOS, make sure the Parallel Port option is not disabled in the Setup Utility. For information on using the Setup Utility, see "Starting the Setup Utility" on page 78.



*If any of these problems continue after taking the actions listed, run the diagnostics programs that came with your computer. If you need service, see "HelpWare Support and Services" on page 85.*

**If the problem is...**

**Here's what to do...**

**Printer error**

- 10** Make sure the Parallel Port Mode option in the Setup Utility is set to a mode that matches your printer. For information on using the Setup Utility, see "Starting the Setup Utility" on page 78.
- 11** If you have other devices connected to the parallel port, disconnect them and connect only the printer. Try to print again.
- 12** Avoid using a printer cable that is more than 6 feet long.  
For additional help, refer to the documentation that came with the printer.



*If any of these problems continue after taking the actions listed, run the diagnostics programs that came with your computer. If you need service, see "HelpWare Support and Services" on page 85.*



# Troubleshooting

---

## Solving software problems

---

If the problem is...	Here's what to do...
----------------------	----------------------

---

<b>Cannot open Aptiva Help</b>	
--------------------------------	--

- |  |   |
|--|---|
|  | <ol style="list-style-type: none"><li>1 Check Windows Explorer to make sure the files are installed. The Aptiva Help files are located in C:\IBMTOOLS\APTHELP.</li><li>2 If the files are not in C:\IBMTOOLS\APTHELP, you can reinstall the files from the "Product Recovery and Diagnostics CD-ROM" by following the instructions in "To reinstall Aptiva Help." on page 26.</li></ol> |
|--|---|



*Periodically use the IBM Update Connector to look for available updates for the software that came from the factory with your computer. For information about the IBM Update Connector, see the Aptiva Help.*

*If any of these problems continue after taking the actions listed, run the diagnostics programs that came with your computer. If you need service, see "HelpWare Support and Services" on page 85.*

---

**If the problem is...****Here's what to do...****Computer does not go on Standby**

The following steps can be tried on systems that exit Standby when the system detects motion of the keyboard, mouse or drives:

- 1** Make sure you don't touch the mouse or keyboard, and don't start a program that involves using the modem or drives. These activities reset the timer.
- 2** Make sure you leave the mouse on a surface that does not vibrate. Leaving the mouse on top of your computer or on top of another machine may reset the timer before the set time has elapsed.
- 3** Allow a few minutes more than the specified time. Windows periodically accesses the hard disk drive for memory swapping and this activity resets the timer. Windows might access the hard disk drive for a short time after you last touched your computer.
- 4** Try disabling AutoPlay of the CD or DVD drives. When AutoPlay is enabled, the Power Management software may detect activity in the CD or DVD drive and keep the computer from going on Standby.
- 5** Make sure the computer is not receiving a fax or connected to the Internet or a bulletin board service (BBS).



*Periodically use the IBM Update Connector to look for available updates for the software that came from the factory with your computer. For information about the IBM Update Connector, see the Aptiva Help.*

*If any of these problems continue after taking the actions listed, run the diagnostics programs that came with your computer. If you need service, see "HelpWare Support and Services" on page 85.*

# Troubleshooting

## If the problem is...

## Here's what to do...

### The system does not turn off when you press the on/off switch

- 1** If running Windows, check the Power Management utility of the Control Panel. The system should behave according to this setting.
- 2** If you are outside Windows (for example, in DOS), you may need to hold the On/Off button for 4 seconds to turn the power off.
- 3** Enter the Setup Utility and select **Power Management**. Ensure that the Power Switch<4 sec. parameter is set to **Power Off**.

### The system does not go into suspend when you press the on/off switch

- 1** If running Windows, check the Power Management utility of the Control Panel. The system should behave according to this setting.
- 2** Enter the Setup Utility and select **Power Management**. Ensure that the Power Switch<4 sec. parameter is set to **Standby**.

### The phone rings and the computer comes out of Standby, but a fax isn't received

- The fax software must be open and set to receive faxes. Refer to the documentation that came with your fax software to make sure it is set up to answer the phone.
- In some cases, the computer may require additional rings before a fax is received. Allow the phone to ring a few more times.



*Periodically use the IBM Update Connector to look for available updates for the software that came from the factory with your computer. For information about the IBM Update Connector, see the Aptiva Help.*

*If any of these problems continue after taking the actions listed, run the diagnostics programs that came with your computer. If you need service, see "HelpWare Support and Services" on page 85.*

If the problem is...	Here's what to do...
----------------------	----------------------

<b>The computer won't come out of Standby on Wake-Up On Ring</b>	<ol style="list-style-type: none"> <li data-bbox="592 552 1245 615">1 The modem software must be open when you put your computer on Standby.</li> <li data-bbox="592 615 1245 743">2 Check the System Utility to make sure both the Power Management setting and the Modem Wake-Up on Ring setting are enabled. Refer to "Using the Setup Utility" on page 77.</li> </ol>
--	---



<b>The computer won't take a message out of Standby</b>	The answering machine software must be open and set to receive messages. (Not all systems contain the hardware and software required to receive voice messages.)
---	--

<b>You pressed the system On/Off button, but the computer has not turned off</b>	<ul style="list-style-type: none"> <li data-bbox="592 871 1245 934">• Press the On/Off button on the front of the system unit and hold it for 4 seconds.</li> <li data-bbox="592 934 1245 1031">• If the computer does not turn off after 5 minutes, see "HelpWare Support and Services" on page 85 for information on obtaining service.</li> </ul>
--	--



# Troubleshooting

## Solving monitor problems

If the problem is...	Here's what to do...
<b>Discolored screen</b>	<ol style="list-style-type: none"> <li><b>1</b> Make sure that your monitor controls are adjusted correctly.</li> <li><b>2</b> Move the monitor away from any equipment that might cause magnetic interference; for example, other monitors, external audio speakers, or microphones. (Some models of the computer come with microphones and speakers, which are shielded to prevent magnetic interference.) Turn off the monitor, wait 30 minutes, and then turn on the monitor again.</li> <li><b>3</b> Select a new color palette setting. For instructions on working with color palette settings, see the online help files that came with the operating system.</li> <li><b>4</b> Make sure the monitor cable is correctly and securely connected to the system unit.</li> <li><b>5</b> If another monitor is available, connect it to your system unit. If the problem is corrected, something may be wrong with your monitor.</li> <li><b>6</b> You may need to DeGauss your monitor. If the monitor you purchased came with a manual DeGauss feature, check the documentation that came with the monitor for information on how to use this feature.</li> </ol>
<b>Picture shape on monitor screen is poor</b>	Adjust the monitor controls. For instructions, refer to the documentation that came with the monitor.
	<i>If any of these problems continue after taking the actions listed, refer to the documentation that came with your monitor. If you need service, see "HelpWare Support and Services" on page 85.</i>

**If the problem is...****Here's what to do...****Display fonts appear cut off or pushed together**

While your monitor resolution may let you change the font size, some programs do not support large fonts. Large fonts may cause words to appear cut off or pushed together. Check the display properties settings to verify that small fonts are selected. For instructions on working with display properties, see the online help files that came with the operating system.

**White screen**

- 1** Make sure the monitor cable is correctly and securely connected to the system unit.
- 2** Make sure the system is turned on.
- 3** If another monitor is available, connect it to your system unit. If the problem is corrected, something may be wrong with your monitor.

**Flickering or unsteady picture on monitor screen**

- 1** Select display settings for a lower resolution, fewer colors, or a higher refresh rate. For instructions on working with display properties, see the online help files that came with the operating system.
- 2** If your monitor is located close to another monitor, move the two monitors farther away from each other.

**Screen is an intense yellow, magenta (purple or red-blue), or cyan (blue-green) color**

Refer to the documentation that came with your monitor. If you need service, see "HelpWare Support and Services" on page 85.



*If any of these problems continue after taking the actions listed, refer to the documentation that came with your monitor. If you need service, see "HelpWare Support and Services" on page 85.*

# Troubleshooting

## If the problem is...

## Here's what to do...

### Adjustments from earlier use were not saved

You may have selected more user-definable modes than the monitor can save. When this occurs, the newest mode replaces the oldest mode. Use the monitor controls to adjust the image for the display mode you are using.

### Any of the following:

- Totally blank screen
- No cursor is displayed
- Only the cursor is displayed
- Screen is unreadable
- Other monitor problems

- 1** If you have enabled the Standby feature, press the power button on the front of the system unit to take your system out of Standby.
- 2** Make sure the monitor cable is correctly and securely connected to the system unit.
- 3** Make sure the system unit and monitor power cords are securely plugged into electrical outlets.
- 4** Make sure the system and monitor are turned on. (The power lights on the computer and the monitor are lit when the power is on.)
- 5** Adjust the monitor controls.
- 6** Change the background colors in your software program or try using a different software program.
- 7** Turn off your computer, unplug the system power cord from the electrical outlet, wait 15 seconds, and then plug the power cord back into the electrical outlet. Restart the computer.



*If any of these problems continue after taking the actions listed, refer to the documentation that came with your monitor. If you need service, see "HelpWare Support and Services" on page 85.*

---

## Solving audio, multimedia, and modem problems

---

### If the problem is...

### Here's what to do...

---

**You installed new speakers and the audio is either low or extremely loud and distorted**

Verify that your speakers are attached to the correct audio connector. The number of audio connectors vary depending on the type of audio installed in your computer. Powered speakers (speakers that use batteries or an external power adapter) connect to the connector labeled "Line out." Unpowered speakers connect to the connector labeled "Speakers." Some models do not have a connector labeled "Speakers" and therefore, do not support unpowered speakers.

**You don't hear sound in Windows**

- 1** Check your computer's volume controls. See the Help files that came with the operating system for information about setting volume.
- 2** Make sure your speakers are connected properly. If your speakers have a power light, make sure the light is lit. For instructions on connecting your speakers, refer to the *Setup Poster* or the instructions that came with your speakers.
- 3** Make sure the program you are using is designed for use in Windows. If the program is designed to run in DOS, it does not use Windows sound features and must be configured to use SoundBlaster Pro or SoundBlaster emulation.



*If any of these problems continue after taking the actions listed, refer to any documentation that may have come with your modem and sound cards. If you find no solution there, run the diagnostics programs that came with your computer. If you need service, see "HelpWare Support and Services" on page 85.*

---



# Troubleshooting

## If the problem is...

## Here's what to do...

**You don't hear sound when you play DOS games or use DOS programs**

- 1** Make sure the game or program is configured to use SoundBlaster Pro or SoundBlaster emulation. Refer to the documentation that came with your DOS program for instructions on selecting sound card settings.
- 2** Refer to the Aptiva help for information on running your DOS game or program in DOS mode.
- 3** Shut down and restart your computer in MS-DOS mode. Then try to run the program again.

**Joystick or gamepad does not work or does not work properly**

- 1** Make sure that the joystick or gamepad is properly connected to the computer.
- 2** You may need to recalibrate the joystick or gamepad. You can recalibrate a joystick or gamepad in the Joystick section of the Windows Control Panel.
- 3** Refer to the documentation that came with the joystick or gamepad for additional troubleshooting information.



*If any of these problems continue after taking the actions listed, refer to any documentation that may have come with your modem and sound cards. If you find no solution there, run the diagnostics programs that came with your computer. If you need service, see "HelpWare Support and Services" on page 85.*

**If the problem is...****Here's what to do...****When you try to use the modem, it doesn't work**

- 1 If you added a modem, make sure it is installed properly.
- 2 Make sure your communications program is configured correctly. The following settings are suggested for compatibility:
  - Modem type:
    - Generic Hayes-type modem
    - Hayes compatible error correcting
    - Hayes compatible high speed
    - User-defined modem
    - Hayes modem
    - Other

If you select a modem type of **Other**, you must include the proper modem initialization string. For most programs, the initialization string `AT&F` will work.

- Baud rate:
  - 115,200 Kbps or the maximum setting offered by your communications software
- COM port:
  - COM1

For help on how to configure, refer to the documentation that came with your communications program.



*If any of these problems continue after taking the actions listed, refer to any documentation that may have come with your modem and sound cards. If you find no solution there, run the diagnostics programs that came with your computer. If you need service, see "HelpWare Support and Services" on page 85.*

# Troubleshooting

## If the problem is...

## Here's what to do...

### Can't use second modem

If you added a second modem:

- Make sure that the telephone line is connected to the modem you want to use.
- Make sure that the communications software you are using is properly configured to use the second modem.
- Make sure that the second modem is properly configured. A second modem must use a different COM port and system IRQ from the first modem. For help on how to configure, refer to the documentation that came with your communications program.

### When you try to use the modem, your computer or modem is unable to detect a dial tone

- 1 Make sure the telephone line is correctly connected to your computer. For instructions on connecting your computer to the telephone network, refer to the *Setup Poster*.
- 2 Make sure no one is using the telephone.
- 3 Make sure the telephone line is working.
- 4 Add the modem command `x3` to the initialization string for the communications program you are using. For help with changing the initialization string, refer to the documentation that came with your communications program.



*If any of these problems continue after taking the actions listed, refer to any documentation that may have come with your modem and sound cards. If you find no solution there, run the diagnostics programs that came with your computer. If you need service, see "HelpWare Support and Services" on page 85.*

## Solving DVD problems

If the problem is...	Here's what to do...
<b>Black screen instead of DVD video</b>	<ol style="list-style-type: none"> <li>1 Restart the DVD player program.</li> <li>2 Close any open files, shut down Windows, and restart your computer.</li> </ol>
<b>DVD movie will not play</b>	<ol style="list-style-type: none"> <li>1 Make sure that the disc surface is clean and not scratched.</li> <li>2 Check the disc for regional coding. You may need to purchase a disc with coding for the region in which you are using your computer.</li> </ol>
<b>No audio or intermittent audio while playing DVD movie</b>	<ol style="list-style-type: none"> <li>1 Check the volume control settings in Windows or on your speakers.</li> <li>2 Make sure that the disc surface is clean and not scratched.</li> <li>3 Check all cable connections to and from the speakers.</li> </ol>
<b>Playback is very slow or choppy</b>	<ol style="list-style-type: none"> <li>1 Disable any background programs, such as AntiVirus or Desktop Themes.</li> <li>2 Ensure that video resolution is set to less than 1152x864 bits.</li> </ol>
<b>Invalid disk or no disk found</b>	<ol style="list-style-type: none"> <li>1 Ensure that a DVD video is in the drive with the shiny side of the disk facing down.</li> <li>2 Ensure that video resolution is set to less than 1152x864 bits.</li> </ol>



*If any of these problems continue after taking the actions listed, refer to any documentation that may have come with your modem and sound cards. If you find no solution there, run the diagnostics programs that came with your computer. If you need service, see "HelpWare Support and Services" on page 85.*

# Troubleshooting

## Responding to error codes

### Error code and description Here's what to do...

<b>Screen is black (no error code)</b>	If you added hardware, remove it and restart the computer to see if the problem is corrected. If the problem is corrected, you may have installed your hardware incorrectly. Reinstall your hardware.
<b>Beep occurs in Power-On Self-Test (POST)</b>	<ul style="list-style-type: none"> <li>• If you <u>installed memory modules or adapter cards</u>, make sure you installed them correctly.</li> <li>• If you <u>did not install memory modules or adapter cards</u>, see "HelpWare Support and Services" on page 85 for information on obtaining service.</li> </ul>
<b>Press &lt;Esc&gt; to turn off NMI or other key to reboot</b>	<ol style="list-style-type: none"> <li>1 Press <b>Esc</b> to turn off the Non-Maskable Interrupt (NMI) and proceed to boot the system.</li> <li>2 Press any other key to reboot the system.</li> </ol>
<b>111</b>	Load the Setup default settings and reboot the system. For more information on using the Setup Utility, see "Using the Setup Utility" on page 77.
<b>I/O Parity Error</b>	
<b>127</b>	If you changed your processor, this is expected; otherwise, load the default settings in Setup. For more information on using the Setup Utility, see "Using the Setup Utility" on page 77.
<b>CPU Clock Mismatch</b>	
<b>151/163</b>	Enter the Setup Utility and reset the date and time. For more information on using the Setup Utility, see "Using the Setup Utility" on page 77.
<b>Real Time Clock Error</b>	
<b>Date and time incorrect</b>	
	<i>If any of these problems continue after taking the actions listed, run the diagnostics programs that came with your computer. If you need service, see "HelpWare Support and Services" on page 85.</i>

Error code and description	Here's what to do...
<b>161</b> <b>CMOS Battery is Bad</b>	Load the Setup default settings and reset the date and time. If it reoccurs, replace the battery. For more information on using the Setup Utility, see "Using the Setup Utility" on page 77.
<b>162</b> <b>CMOS Checksum Error</b>	Load the Setup default settings and reboot the system. Also, check the date and time. For information on using the Setup Utility, see "Starting the Setup Utility" on page 78.
<b>162</b> <b>Equipment Configuration Error</b>	<ol style="list-style-type: none"> <li>1 This message appears together with other specific error messages indicating the device with an error. First, find the device error message in this table and do the corresponding action.</li> <li>2 Enter the Setup Utility and change the required settings. For information on the Setup Utility options, see the Aptiva Help and the Setup Utility help.</li> </ol>
<b>164</b> <b>Memory size changed</b>	If you removed the memory, this is expected. If you did not remove the memory, do the following: <ol style="list-style-type: none"> <li>1 Make sure the DIMMs are properly installed, then reboot the system.</li> <li>2 If you still receive the error message after doing option 1, the DIMMs may be defective. Change the DIMMs. For instructions on working with system board components, see Chapter 7, "Adding and removing hardware."</li> </ol>
	<i>If any of these problems continue after taking the actions listed, run the diagnostics programs that came with your computer. If you need service, see "HelpWare Support and Services" on page 85.</i>



# Troubleshooting

Error code and description	Here's what to do...
<b>201</b> <b>Memory Error at</b> <b>MMMM:SSSS:0000h</b> <b>(R:xxxxh, W:xxxh)</b>	<ol style="list-style-type: none"> <li>1 Make sure the DIMMs are properly installed, then reboot the system.</li> <li>2 If you still receive the error message after doing option 1, the DIMMs may be defective. Change the DIMMs. For instructions on working with system board components, see Chapter 7, "Adding and removing hardware".</li> </ol>
<b>301</b> <b>PS/2 Keyboard Error or</b> <b>Keyboard Not Connected</b>	<ol style="list-style-type: none"> <li>1 Plug in the keyboard properly and reboot the system.</li> <li>2 If the error still shows after doing option 1, change your keyboard. It may be defective.</li> </ol>
<b>303</b> <b>PS/2 Keyboard Interface</b> <b>Error</b>	<ol style="list-style-type: none"> <li>1 Plug in the keyboard properly and reboot the system.</li> <li>2 If the error still shows after doing option 1, change your keyboard. It may be defective.</li> </ol>
<b>648</b> <b>Floppy Drive(s) Write</b> <b>Protected</b>	<ol style="list-style-type: none"> <li>1 Make sure the diskette protection tab is set correctly.</li> <li>2 Enter the Setup utility. Select <b>Advanced Options</b> then <b>Security Options</b>. Make sure that the Diskette Drive parameter is set to <b>Normal</b>. For information on using the Setup Utility, see "Using the Setup Utility" on page 77.</li> </ol>
	<p><i>If any of these problems continue after taking the actions listed, run the diagnostics programs that came with your computer. If you need service, see "HelpWare Support and Services" on page 85.</i></p>

---

**Error code and description    Here's what to do...**

---

<b>662</b> <b>Floppy Disk Controller Error</b>	Load the Setup default settings in the Setup Utility. For information on using the Setup Utility, see "Starting the Setup Utility" on page 78.
<b>662</b> <b>Floppy Drive A Error</b>	<ol style="list-style-type: none"> <li><b>1</b> Make sure that the Diskette Drive A parameter setting within the Setup Utility is correct. For information on Setup Utility options, see the Aptiva Help and the Setup Utility help.</li> <li><b>2</b> Make sure the diskette drive signal cable is properly connected to the drive and to the system board.</li> <li><b>3</b> Make sure the drive power cable is properly plugged in.</li> <li><b>4</b> If the error still shows after doing steps 1 to 3, the diskette drive may be defective.</li> </ol>
<b>662</b> <b>Onboard Floppy Drive Conflict(s)</b>	<ol style="list-style-type: none"> <li><b>1</b> Remove all the add-on cards in the system.</li> <li><b>2</b> Power on the system to see if it works without the cards.</li> <li><b>3</b> Re-install the cards one by one to determine which of the cards caused the error.</li> <li><b>4</b> After determining the defective card or cards, replace the cards.</li> </ol> <p>For information on installing adapter cards, see Chapter 7, "Adding and removing hardware."</p>



*If any of these problems continue after taking the actions listed, run the diagnostics programs that came with your computer. If you need service, see "HelpWare Support and Services" on page 85.*

---



# Troubleshooting

## Error code and description    Here's what to do...

---

**962**

**Onboard Parallel Port Conflict(s)**

- Enter the Setup Utility and do any of the following:
- Change the onboard parallel port I/O address and IRQ or disable it.
  - Change the add-on card parallel port I/O address and IRQ then reboot the system.
- For information on using the Setup Utility, see "Starting the Setup Utility" on page 78.
- 

**1162**

**Onboard Serial Port Conflict(s)**

- Enter the Setup Utility and do any of the following:
- Change the onboard serial port I/O address and IRQ or disable it.
  - Change the add-on card serial port I/O address and IRQ then reboot the system.
- For information on using the Setup Utility, see "Starting the Setup Utility" on page 78.
- 

**1755**

**Hard Disk Drive(s) Write Protected**

Enter the Setup Utility and make sure that the Hard Disk Drive parameter setting is set to **Normal**. For information on using the Setup Utility, see "Starting the Setup Utility" on page 78.

---



*If any of these problems continue after taking the actions listed, run the diagnostics programs that came with your computer. If you need service, see "HelpWare Support and Services" on page 85.*

---

---

**Error code and description    Here's what to do...**

---

**1762****Onboard IDE Channel  
Address Conflict(s)**

- 1** Remove all the add-on cards in the system.
- 2** Power on the system to see if it works without the cards.
- 3** Reinstall the cards one by one to determine which of the cards caused the error.
- 4** After determining the defective card or cards, enter the Setup Utility and set the Reset Resource Assignments parameter setting to **Yes**, then reboot the system.
- 5** If the problem still shows, set the Onboard IDE Primary/Secondary Channel parameter to **Disabled**, then reboot the system.  
For information on using the Setup Utility, see "Starting the Setup Utility" on page 78.

**1780****IDE Primary Channel  
Master Drive Error**

- 1** Make sure the IDE signal cable is properly connected to the drive and to the system board.
- 2** Make sure the drive power cable is properly connected.
- 3** Enter the Setup Utility and make sure that the IDE Primary Channel Master parameter setting is set to **Auto**. For information on the Setup Utility options, see the Aptiva Help and the Setup Utility help.
- 4** If the error still shows after performing the above steps, the IDE drive may be defective. For information on using the Setup Utility, see "Starting the Setup Utility" on page 78.



*If any of these problems continue after taking the actions listed, run the diagnostics programs that came with your computer. If you need service, see "HelpWare Support and Services" on page 85.*

---

# Troubleshooting

## Error code and description    Here's what to do...

---

**1781**

**IDE Primary Channel  
Slave  
Drive Error**

- 1** Make sure the IDE signal cable is properly connected to the drive and to the system board.
- 2** Make sure the drive power cable is properly connected.
- 3** Enter the Setup Utility and make sure that the IDE Primary Channel Slave parameter setting is set to **Auto**. For information on using the Setup Utility, see "Starting the Setup Utility" on page 78.
- 4** If the error still shows after performing the above steps, the IDE drive may be defective. For more information on using the Setup Utility, see "Using the Setup Utility" on page 77.

**1782**

**IDE Secondary Channel  
Master  
Drive Error**

- 1** Make sure the IDE signal cable is properly connected to the drive and to the system board.
- 2** Make sure the drive power cable is properly connected.
- 3** Enter the Setup Utility and make sure that the IDE Secondary Channel Master parameter setting is set to **Auto**. For information on using the Setup Utility, see "Starting the Setup Utility" on page 78.
- 4** If the error still shows after performing the above steps, the IDE drive may be defective. For more information on using the Setup Utility, see "Using the Setup Utility" on page 77.



*If any of these problems continue after taking the actions listed, run the diagnostics programs that came with your computer. If you need service, see "HelpWare Support and Services" on page 85.*

---

**Error code and description    Here's what to do...**

---

- 1783**  
**IDE Secondary Channel Slave Drive Error**
- 1 Make sure the IDE signal cable is properly connected to the drive and to the system board.
  - 2 Make sure the drive power cable is properly connected.
  - 3 Enter the Setup Utility and make sure that the IDE Secondary Channel Slave parameter setting is set to **Auto**. For information on using the Setup Utility, see "Starting the Setup Utility" on page 78.
  - 4 If the error still shows after performing the above steps, the IDE drive may be defective. For more information on using the Setup Utility, see "Using the Setup Utility" on page 77.
- 

- 1800**  
**IRQ Setting Error**  
**PnP ISA Card(s) Disabled**
- 1 Enter the Setup Utility and set the Reset Resource Assignments to **Yes**, then reboot the system.
  - 2 If the error message reappears, determine which onboard device is least necessary and disable it under the Input/Output Ports menu in Setup. For information on using the Setup Utility, see "Starting the Setup Utility" on page 78.
- 

- 1801**  
**Expansion ROM Allocation Failed**
- 1 Enter the Setup Utility and set the Reset Resource Assignments to **Yes**, then reboot the system.
  - 2 Change the I/O expansion ROM address. For information on using the Setup Utility, see "Starting the Setup Utility" on page 78.
- 



*If any of these problems continue after taking the actions listed, run the diagnostics programs that came with your computer. If you need service, see "HelpWare Support and Services" on page 85.*

---

# Troubleshooting

## Error code and description    Here's what to do...

---

**1802**

### I/O Resource Conflict(s)

- 1** Enter the Setup Utility and set the Reset Resource Assignments to **Yes**, then reboot the system. For information on using the Setup Utility, see "Starting the Setup Utility" on page 78.
- 2** If the error message reappears, determine which onboard device is least necessary and disable it under the Input/Output Ports menu in Setup. For information on using the Setup Utility, see "Starting the Setup Utility" on page 78.

**1803**

### Memory Resource Conflict(s)

- 1** Enter the Setup Utility and set the Reset Resource Assignments to **Yes**, then reboot the system. For information on using the Setup Utility, see "Starting the Setup Utility" on page 78.
- 2** If the error message reappears, determine which onboard device is least necessary and disable it under the Input/Output Ports menu in Setup. For information on using the Setup Utility, see "Starting the Setup Utility" on page 78.



*If any of these problems continue after taking the actions listed, run the diagnostics programs that came with your computer. If you need service, see "HelpWare Support and Services" on page 85.*

---

**Error code and description    Here's what to do...**

---

**1962**  
**Insert system diskette and press <Enter> to reboot**

- 1** Insert a system diskette into drive A and press **Enter** to reboot the system.
- 2** If the system works when you boot from drive A, your hard disk may have a problem.
- 3** Make sure that your hard disk is properly installed. Check all cable connections. For information on using the Setup Utility, see "Starting the Setup Utility" on page 78.

---

**8601/8603**  
**PS/2 Pointing Device Interface Error**

- 1** Make sure that the mouse is plugged in the PS/2 mouse port, then reboot the system.
- 2** If the error still shows after doing option 1, replace the PS/2 mouse. It may be defective.



*If any of these problems continue after taking the actions listed, run the diagnostics programs that came with your computer. If you need service, see "HelpWare Support and Services" on page 85.*

---

# Troubleshooting

## Recovering factory installed programs and files



### Note

*Some models ship with the ConfigSafe program, which runs in the background. ConfigSafe automatically takes a snapshot of your configuration files. Before doing a full recovery, you might want to start ConfigSafe and restore system files to see if an earlier snapshot might fix your problem.*

Your Aptiva PC came with programs and files installed on the hard disk drive. These pre-installed programs and files are also included on the "Product Recovery and Diagnostics CD-ROM" disc. In some cases, the original programs and files on the hard disk drive can become corrupted. If this happens, you will need to reinstall them on the hard disk drive.

You may also install programs and create your own files. When you install programs, the installation process can change certain configuration files that the operating system uses. You should make regular backup copies of these configuration files and any files you created. For information on backing up files, see the Aptiva Help.

When you make backup copies of the operating system configuration files, you should copy the original directory structure. When you reinstall the files, you must put them into the original directory structure. If you do not, the computer may not work properly.

To recover the factory installed system and program files, follow these steps:

**Note:** All personal data in the computer will be lost.

- 1 Make sure your computer is turned on.
- 2 Make backup copies of configuration files and any files you created. For information on backing up files, see the Aptiva Help.
- 3 Insert the "Product Recovery and Diagnostics CD-ROM" disc into your CD or DVD drive.
- 4 Make sure you do not have a diskette, CD, or DVD in any other drive.
- 5 Shut down and turn off your computer.

- 6 Wait 15 seconds.
- 7 Turn on your monitor and computer.
- 8 When you see the IBM Product Recovery Program Main Menu, select **Full Recovery** and follow the instructions on the screen.
- 9 Remove the disc before you restart your computer at the end of the recovery.
- 10 After the Aptiva software has been reinstalled, copy your personal configuration and data files back into their original directories on the hard disk drive.

If you need to use the "Product Recovery and Diagnostics CD-ROM" disc, you should make sure that the Setup Utility is set up to use the CD or DVD drive before the hard disk. The CD or DVD drive is set at the factory as the first startup device. For more information about selecting startup devices in the Setup Utility, see the Setup Utility help.

---

## Reinstalling device drivers

When you reinstall device drivers, you are changing the current configuration of your computer. Only reinstall device drivers if you know that it is necessary to do this in order to correct a problem on your computer. Copies of the device drivers that came preinstalled on your Aptiva are located on the Aptiva "Product Recovery and Diagnostics CD-ROM" in a folder called "Drivers".

If you need to reinstall a device driver, refer to the "Drivers" folder on the CD-ROM and choose the appropriate device subfolder. Drivers can be reinstalled using one of the following methods:

- In the device subfolder, look for a "Readme.txt" or another file with the ".txt" extension. Sometimes this file may be named after the operating system, such



# Troubleshooting

as "Win98.txt". The text file will contain information on how to reinstall that device driver.

or

- Use the Add New Hardware program (located in the Control Panel) to reinstall the driver. Not all drivers can be reinstalled in this manner. If the device subfolder contains an ".inf" file, you can use the Add New Hardware program. In the Add New Hardware program, when prompted for the device driver you want to install, select **Have Disk**, and **Browse**. Then select the appropriate device driver file from the Aptiva "Product Recovery and Diagnostics CD-ROM"

or

- In the device subfolder, look for a Setup.exe file. Double-click on the Setup.exe file and follow the instructions on the screen.

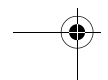
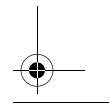
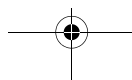
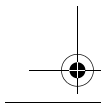
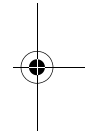
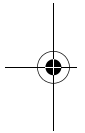
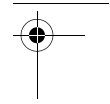
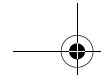
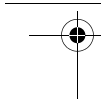

# Chapter 5

## Setup Utility

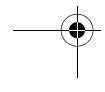
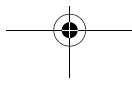
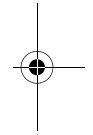
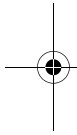
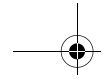

# Setup Utility

Your IBM Aptiva Personal Computer comes ready to use. You can use the Setup Utility and the Windows Device Manager to view your computer's configuration settings.

You can also use the Setup Utility to change some configuration settings. If you add or replace hardware inside your computer, you might need to verify or update specific settings.

This chapter contains instructions for how to use the Setup Utility. If you need additional information about the Setup Utility options, see the Setup Utility help.

---

## Using the Setup Utility

The Setup Utility lets you view and change configuration settings for hardware installed in your computer. You might need to use the Setup Utility if you upgrade the hardware in your computer or if you get an error message while using your computer.

### Automatic changes

In most cases, your computer's Basic Input/Output System (BIOS) can make changes automatically. When you install new hardware, the BIOS detects it during the Power-On Self-Test (POST) and automatically updates the Setup Utility.

### Manual changes

In some cases, your computer will not make changes automatically. For example, if you install hardware that does not meet Plug and Play requirements, you will need to start the Setup Utility and make changes manually.

The Setup Utility includes the following hardware and configuration information:

- Processor speed
- System, cache, and video memory
- Disk drives
- Serial and parallel ports
- Power Management features
- Plug and Play and PCI resource assignments
- Startup options
- Model information
- Date and time
- Security options

You will not be able to change some Setup Utility options like system and model information because they contain information about the system. Other options let you control how your computer operates. For example, you can use the Setup Utility to:

- Create or change a power-on password.
- Reduce energy consumption with Power Management features.
- Enable or disable the system memory test.

### Starting the Setup Utility

Sometimes, when you get an error message, your computer displays a message window with an error code and a description of the problem. When this occurs, you can press the **F1** key to start the Setup Utility. Otherwise, to access the Setup Utility, you must either start or restart your computer.

# Setup Utility

To start the Setup Utility when your computer is on, follow these steps:

- 1 Save all open files and close all software programs.
- 2 Click the **Start** button on your Windows desktop.
- 3 Click the **Shut Down** option.
- 4 From the Shut Down Windows window, click **Restart the computer** and then click the **Yes** button.
- 5 When the following screen appears, press the **F1** key:



To start the Setup Utility when your computer is off, follow these steps:

- 1 Turn on your monitor.
- 2 Turn on your system.

3 When the following screen appears, press the **F1** key:



The Setup Utility Main Menu appears:



**Note**

*The Main Menu you see on your computer may look slightly different from the menu shown here, but it will operate the same way.*

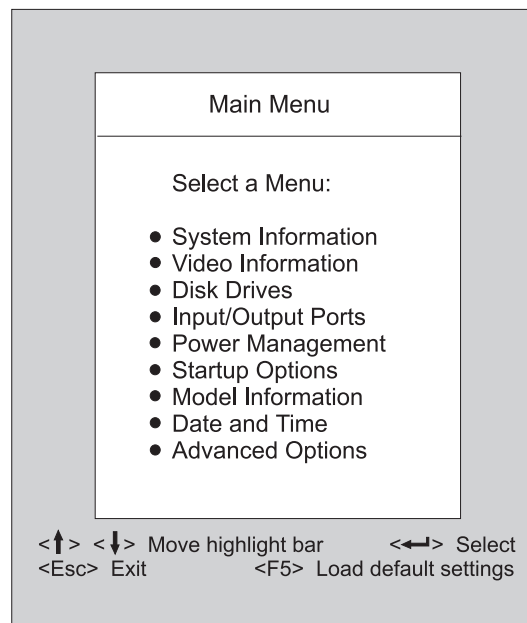



# Setup Utility

## Working with the Setup Utility menus

The Setup Main Menu lists system configuration options. When you select one of these options, a menu for that option appears.

To move through menus, use the following keys:

Keys	Function
↑   ↓	Use these arrow keys to highlight an option on the menu. (Press the <b>Enter</b> key to choose the option.)
←   →	Use these arrow keys to make a selection and change an option's setting. On some menus, you can use these keys to move from one field to another.
<b>Enter</b>	Press this key to choose a highlighted option from a menu.
<b>Esc</b>	After viewing or making changes to the settings on a menu, press this key to exit the menu.
<b>F1</b>	Press this key if you want help for a selected item in a menu.
<b>F5</b>	Press this key if you want to load the factory default settings from the Main Menu.



### Note

*Not all keys on the list are available on every menu. The available keys appear on the bottom of that menu.*

## Viewing system information and model information

To view general hardware information about your computer, select the **System Information** option from the Setup Main Menu. The items displayed in the System Information menu are not configurable.

Setup automatically updates this menu when you do either of the following:

- Add or change hardware on your computer
- Make changes to other menus in Setup and save those changes

To view other computer information such as the model number, serial number, and the BIOS version and date, select the **Model Information** option from the Setup Main Menu. Like in the System Information menu, the items displayed are not configurable.

## Changing parameter settings

In the Setup menus, all configuration information that you can change is enclosed in brackets like these: [ ]. You cannot change any information that is not enclosed in brackets. Use the up or down arrow keys to highlight options then press **Enter** to display a menu. When changing the setting of a particular parameter, highlight the setting then use the left or right arrow key to change the setting. Refer to the Setup Utility help for details on the configurable parameters in each menu.

## Loading the default settings

When you purchase an Aptiva computer, it is already configured for use. The original configuration settings, also called *factory* or *default settings*, are stored in the

# Setup Utility

CMOS. Setup includes an option **Load default settings** that lets you reload the original configuration at any time.

To reload the default settings, follow these steps:

- 1 From the Main Menu, press **F5**. A dialog box appears confirming if you want to load the default settings.
- 2 Use the left arrow key to select **Yes**, then press **Enter**.
- 3 Press **Esc** to exit Setup. A dialog box appears saying "Do you want to save settings?"
- 4 Use the left arrow key to select **Yes**, then press **Enter** to save the changes in CMOS. You must load the Setup default settings in the following instances:
  - when you replace the system battery
  - when you customize your system configuration settings and some resource assignments conflict causing the computer to stop responding.

## Exiting Setup

Press **Esc** to return to the Main Menu when you have finished viewing settings and making changes. From this location, you can exit Setup and save your changes or exit without saving your changes.

Follow these steps to exit setup:

- 1 From the Main Menu, press **Esc** to exit Setup.
- 2 Do either of the following:
  - If you would like to save your changes, press the left arrow key to select the option **Yes** then press **Enter** to save your changes and exit Setup.
  - If you do not want to save your changes, press the right arrow key to select the option **No** then press **Enter**, to exit Setup without saving.

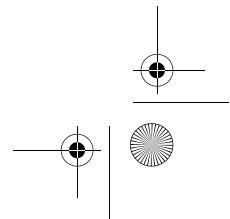
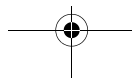
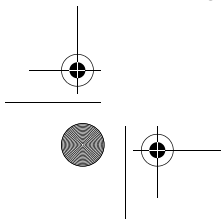
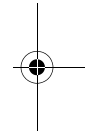
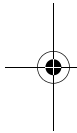
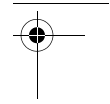
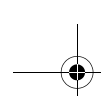
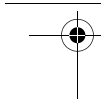

# Chapter 6

## HelpWare Support and Services

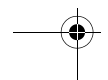
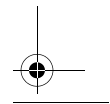
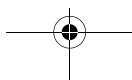
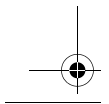
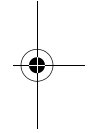
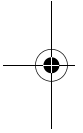
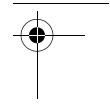
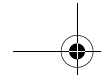
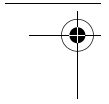

# HelpWare Support and Services

---

## What do I do first?

### What is IBM HelpWare?

IBM HelpWare is a comprehensive set of technical support and service options.

From 30-day "Up and Running" support to help with popular programs, IBM HelpWare has a variety of services and solutions for you. These options are available from IBM whenever you need help for as long as you own your IBM Aptiva Personal Computer. Even when your warranty period expires, HelpWare will still be there to support you with services available for purchase.

Read on to find out when and what methods of support are available at no additional charge and when charges will apply.

### Need quick help?

There are two ways to get help quickly from IBM:

---

<b>Internet</b>	Refer to the section titled "How do I get help electronically?" on page 89 for your country's Internet address.
<b>Telephone</b>	Refer to the section titled "How and when do I contact the IBM PC HelpCenter?" on page 92 for information about the telephone services of HelpWare.

---

## What can I do on my own?

Sometimes you can quickly solve problems that you may have with your computer. We've given you several different methods you can use to solve problems on your own. If you need to, you can still contact IBM for support. There is more information about telephone support in the section titled "How and when do I contact the IBM PC HelpCenter?" on page 92.

**Printed documentation.** The documentation that came with your computer contains information about troubleshooting hardware and software problems. This information begins with the quick step-by-step guide on page 33, which can help you diagnose hardware and software problems. Once you know the nature of the problem, you can follow the instructions in the "Troubleshooting" section on page 29. Just match the description or error codes with your question and follow the instructions to solve the problem!

**Online documentation.** Your computer also came with several online resources you can use to solve problems.

*Help files.* The operating system and most preloaded programs on your computer contain online Help files. The Aptiva Help contains information about software and many common computer tasks specific to Aptiva PCs. Help files may also contain information for questions on how to solve problems and prevent future trouble.

*Readme files.* Most operating systems and software programs also come with a file named README.TXT. This is a text file that contains important information about the program. You can read README.TXT files by opening them in any text file editor on your computer. If an Aptiva Readme file is provided, it is named APTIVA.TXT.



# HelpWare Support and Services

**Software.** Your computer came with several software programs which can help you solve problems or find answers to your questions.

*Diagnostics.* Your computer came with a diagnostic program which can help identify problems you may have with your computer. You can run the *PC Doctor* diagnostic program from *Access Aptiva* in Windows or the "Product Recovery and Diagnostics CD-ROM" disc.

The Windows version of PC Doctor works through the Windows operating system to find system software problems. The "Product Recovery and Diagnostics CD-ROM" contains the MS-DOS version of the PC Doctor diagnostics program. This system utility performs tests directly on the hardware. It is important to run both of these programs before you contact the IBM PC HelpCenter. If you have not yet installed the Windows version of PC Doctor, you must first install the program from the "Software Selections CD-ROM" that came with your computer.

*IBM Update Connector.* This program allows you to connect to the IBM PC HelpCenter to receive updates for some of the software that came with your system and download them. Once you have received the files, you can begin the automated installation process. IBM Update Connector is available to registered Aptiva customers during the warranty period at no additional charge. Telephone line charges may apply.

---

## How do I get help electronically?

### Electronic support

There are many different ways to receive technical support and information if you have questions or problems. Electronic support is easy to use, quick, and very thorough. Best of all, the only charges that typically

*How do I get help electronically?*

89

apply are the ones you pay to your telephone company or the company you use to log onto the World Wide Web. Here are some of the electronic support options that you can use.

**Internet.** You can use the Universal Resource Locator (URL) to contact us on the Internet. When you link to the IBM Aptiva PC support home page, you can search for technical tips, download update drivers and find out about many other things.

For the United States, Canada, Australia, and New Zealand, you can visit the IBM Aptiva PC support Internet site at this URL:

<http://www.ibm.com/pc/support?page=IBM+Aptiva>

For other countries, use the following URL:

<http://www.ibm.com/pc/xx/aptiva.html>

Replace xx with the letters for your country according to the following table:

---

Austria	AT
Belgium	BE
Denmark	DK
Finland	FI
France	FR
Germany	DE
Ireland	UK
Italy	IT

# HelpWare Support and Services

---

Luxembourg	BE
New Zealand	NZ
The Netherlands	NL
Norway	NO
Spain	ES
Sweden	SE
Switzerland	CH
UK and Ireland	UK
US	US

You can access the IBM Knowledge Base from the Web sites. The IBM Knowledge Base is a tool that is used to diagnose common technical problems. In order to use the Knowledge Base, you must first connect to the IBM Aptiva PC Support page and complete a personal profile. Use the IBM Knowledge Base for troubleshooting and step-by-step solutions.

**Online services.** Online services are companies which provide a wide variety of services like electronic mail, newsgroups, and special forums. These companies provide IBM forums where customers can receive technical support and information about IBM products.

*America Online.* If you want to use America Online to find information related to IBM products and services, use the "Go to" keyword `IBM connection`.

**Automated Fax.** In the United States and Canada, if you have a touch-tone telephone and access to a fax machine, you can receive information by fax 24 hours a day, 7 days a week.

To access the Automated Fax System:

- In the United States, call 1-800-426-3395.
- In Canada, call 1-800-465-3299.

Follow the recorded instructions and the information you request will be sent to the fax machine you specify.

A catalog (approximately 40 pages) of Automated Fax topics is available.

---

## How and when do I contact the IBM PC HelpCenter?

### What help can I get by telephone?



#### Note

*For help with installing or "how to" questions for software, see "How and when do I purchase additional support?" on page 98.*

Sometimes you may have a problem that you just can't solve and we understand that it can be frustrating. This document contains several problem-solving options you can use. See the "Quick step guide" on page 33 for troubleshooting information before you call the IBM PC HelpCenter. If you have completed the problem-solving steps in the "Troubleshooting" chapter and you still need help, you may need to call the IBM PC HelpCenter.

System experts are available to help answer your questions. Depending upon the type of problem, there may be charges for some calls and not for others. This section contains information about which calls you will be charged for and which calls you will not. You will be required to register your computer to receive telephone support.

# HelpWare Support and Services

**30-day "Up and Running" support.** If you have questions about setting up your system, we're here to help. Within the first 30 days that you have your computer, you can call us at no additional charge to ask questions about:

- setting up your system and attaching a monitor and printer
- starting the preloaded operating system
- starting the preloaded and bundled software programs

Long distance telephone charges may apply. We will calculate the 30 days from the date of purchase.



## Note

*Make sure you write down your date of purchase and keep your receipt in a safe place. You may be required to present your proof of purchase to receive service under your limited warranty.*

**Software technical support.** If you need help setting up or installing the preloaded or bundled software programs during the 30-day "Up and Running" support period, technical support representatives will help you install (or reinstall) the software that came with your computer if necessary. HelpCenter technicians will ensure that the program is successfully loaded so that you can start the program. Support for your "how to" questions about software programs is available for a fee. For more information, see "How and when do I purchase additional support?" on page 98.

**Additional support.** There are times you may need additional assistance after the 30-day "Up and Running" support period. You may also require "how to" help and support as you use your Aptiva PC. IBM PC HelpCenter technicians can assist you for a fee. For more information, see "How and when do I purchase additional support?" on page 98.

**Hardware warranty service.** In some cases, the Aptiva PC that you purchased may not function as warranted. If this happens, during the period of your warranty, the IBM PC HelpCenter will provide warranty service for IBM factory installed hardware.

*How and when do I contact the IBM PC HelpCenter?*

93



**Note**

*To find your machine and model type as well as your serial number, look on the front lower right corner of the system unit.*

Your Aptiva is subject to the terms of the *IBM Statement of Limited Warranty and IBM Program License Agreement* which are included with your computer. Please read these terms carefully.

If your computer needs to be serviced, please provide the servicer with the Aptiva "Product Recovery and Diagnostics CD-ROM" that came with your computer. This will help the servicer to complete the required service.

If your computer is having a problem that is not covered by the warranty, see "How and when do I purchase additional support?" on page 98.



**Note**

*If your call is not covered by 30-day "Up and Running" support or the warranty, you will be required to provide a major credit card number for support.*

**Before you call...**

The information in the following three steps will provide the IBM PC HelpCenter technical support representative with valuable information that will assist him/her when handling your call. It will also help reduce the amount of time it takes to diagnose problems and answer questions.

- 1** Register your computer with the online IBM Registration form that came installed on your computer.
- 2** If possible, run both the DOS version and the Windows version of PC Doctor diagnostics. Save and print the log files created by both the DOS and Windows versions of diagnostics so that you can provide these for the technical support representative to review. (The log file created in the Windows version is automatically saved in C:\PCDR\detailed.txt.) For information on how to use the PC Doctor diagnostics, please refer to the "Troubleshooting with the Product Recovery and Diagnostics CD-ROM" help topic in the Aptiva Help on your computer.

# HelpWare Support and Services

**3** When you contact the IBM HelpCenter, you will be required to provide the following information:

Name

---

Address

---

---

Telephone number

---

Machine and model type:

---

(find it on the front panel, behind the door)

Serial number:

---

(find it on the front panel, behind the door)

Registration number:

---

(when you receive one)

Date of purchase:

---

- description of the problem
- exact wording of any error messages
- hardware and software configuration information for your system

*How and when do I contact the IBM PC HelpCenter?*

**95**

If your call is not covered by 30-day "Up and Running" support or the Limited Warranty, you may be required to provide a major credit card number for support. You will not be billed if it is determined that your call is covered under "Up and Running" support or the Limited Warranty.

Please be at your computer when you call.

If your country is not listed, contact your IBM reseller or IBM marketing representative.

<b>Country</b>	<b>Phone Number</b>	<b>Hours of Operation</b>
Australia	<b>13-14-26</b>	9am - 9pm (EST - Australia) 365 days a year
Austria	<b>1 546 325 102</b>	8am - midnight CET Monday - Friday
Belgium (Flemish)	<b>02-714-3504</b>	8am - midnight CET
Belgium (French)	<b>02-714-3503</b>	8am - midnight CET
Canada	<b>1-800-565-3344</b>	24 hours a day, 7 days a week (excluding holidays)
Denmark	<b>3525-6904</b>	8am -midnight CET
Finland	<b>(09) 2294 3004</b>	8am -midnight CET
France	<b>01-6932-4004</b>	8am -midnight CET
Germany	<b>069-6654-9004</b>	8am - 8pm CET Monday - Friday
Ireland	<b>01-8159208</b>	7am - 11pm GMT
Italy	<b>02-4827-7003</b>	8am -midnight CET
Luxembourg	<b>298-977-5058</b>	8am - midnight CET



# HelpWare Support and Services

Country	Phone Number	Hours of Operation
New Zealand	<b>0800-446-149</b>	9am - 9pm (EST - Australia) 365 days a year
The Netherlands	<b>020-504-0530</b>	8am - midnight CET
Norway	<b>2-305-0304</b>	8am - midnight CET
Portugal	<b>01 791-5147</b>	9am - 7pm GMT
Spain	<b>91-662-4261</b>	8am - midnight CET
Sweden	<b>08-632-0051</b>	8am - midnight CET
Switzerland (German)	<b>0848 80 55 00</b>	8am - 8pm CET Monday - Friday
Switzerland (French)	<b>0848 80 55 00</b>	8am - midnight CET
UK	<b>01475-555 001</b>	7am - 11pm GMT
US and Puerto Rico	<b>1-919-517-2800</b>	24 hours a day, 365 days a year (response times may vary)

In the United States and Canada, the support representative may also be able to fax or mail additional technical or product information to you, such as:

- sales information
- product brochures
- locations of IBM resellers
- services available through IBM

If you need help with a specific program or if you need help after your warranty has ended, these services are available for a fee. For more information about additional services, see "How and when do I purchase additional support?".

---

## How and when do I purchase additional support?

### Purchasing additional HelpWare services

During and after the warranty period for your computer, you can purchase additional HelpWare services. Our Enhanced PC Support service includes assistance with the following items:

- assistance with installing, configuring, and using selected software applications
- using the operating system
- setting up and using multimedia drivers
- installing and configuring out-of-warranty IBM PC products

### You can purchase support in the following ways:

**Note:** All of the following support options are available in all countries unless otherwise noted.

*900 number.* In the United States and Canada, to receive immediate support from an IBM PC HelpCenter technical support representative you can call the 900 number. Your local telephone company will bill you by the minute for each call. Persons under age 18 must have permission of a parent or legal guardian prior to placing the call.

# HelpWare Support and Services

<b>United States</b>	For installing and configuring in-warranty IBM Aptiva products: <b>1-900-555-HELP(4357)</b>	Monday - Friday 9am to 9pm Eastern Time	\$2.99 (US currency) per minute beginning after the first minute
	For using application software and for out-of-warranty IBM products: <b>1-900-555-CLUB(2582)</b>	Monday - Friday 9am to 9pm Eastern Time	\$2.99 (US currency) per minute beginning after the first minute
<b>Canada</b>	<b>1-900-565-9988</b>	24 hours a day	\$3.50 (Canadian currency) per minute



## Note

*In most countries, all available options are payable by credit card only. In Australia, all options are payable by credit card, cheque, or money order.*

*Flat rate.* You may call the IBM PC HelpCenter to purchase support for a single incident or multiple incidents (in Canada, call the toll free number listed on page 94). The flat-rate option is not available in Australia or New Zealand.

*Single incident.* The single incident option allows you to pay a flat fee for each individual problem you need to resolve.

*3-incident pack.* The 3-incident pack allows you to purchase a block of problem resolutions at a discount from the single incident price. The 3-incident pack expires one year from the date of purchase.

*5-incident pack.* In Australia and New Zealand, the 5-incident pack allows you to purchase a block of problem resolutions at a discount from the single-incident price. The 5-incident help pack expires one year from the date of purchase.

*10-incident pack.* In the United States, Canada, Australia, and New Zealand, the 10-incident pack allows you to purchase a block of problem resolutions at a discount from the single-incident price. The 10-incident pack expires one year from the date of purchase.

An incident is a request for telephone assistance about a single question or problem. An incident may involve multiple conversations or actions which may include (but are not limited to):

- your initial request
- research by IBM
- a call back from IBM to you.

Requests for assistance on multiple questions or problems will be considered as multiple incidents.

**To order additional support packages.**

- Refer to page 96 for the phone numbers and hours of operation in your country.
- In the United States and Canada, use the following part numbers when you call:

	<b>US Part Number</b>	<b>Canadian Part Number</b>
<b>single incident</b>	2419720	EPCS1
<b>3-incident pack</b>	2419721	EPCS3
<b>10-incident pack</b>	2419722	EPCS10

# HelpWare Support and Services

## For more information

The Enhanced PC Support service is available for products on the Supported Products list. To receive a brochure of the Enhanced PC Support service or a Supported Products list from our automated fax system:

- In the United States:
  - 1 Call 1-800-426-3395.
  - 2 Select option 1.
  - 3 Select option 1.
  - 4 Enter one of the following document numbers:
    - For a brochure, enter 11690 and press the # key.
    - For a supported products list, enter 11682 and press the # key.
  - 5 When you have finished, press 1.
  - 6 Enter your fax number and press the # key.
- In Canada, contact IBM HelpFax:
  - 1 Call 1-800-465-3299.
  - 2 Select appropriate language.
  - 3 Select option 1.
  - 4 Select option 1.
  - 5 Enter one of the following document numbers:
    - For a brochure, enter 16129.
    - For a supported products list, enter 16130.
  - 6 Follow the instructions given to complete the call.
- In all other countries, contact your IBM reseller or IBM marketing representative.

## Express Maintenance

Customers in the United States and Canada have "Express Maintenance" which is a parts exchange service that allows IBM HelpCenter personnel to replace selected in-warranty hardware parts and ship them directly to your door. This means you won't have to completely disassemble your computer and take it to an authorized IBM servicer for repair. Some servicers function as drop-off points that may send your system to another location for repair.

When you call for Express Maintenance at 1-919-517-2800, your credit card information will be requested, but it will not be billed if you return the defective part to IBM within 30 days of your receipt of the new part. If the part is not returned within 30 days, your card will be charged the full retail price of the part. Credit card information will not be made available to anyone outside IBM.

---

## International Warranty Service - Not Available

International Warranty Service (IWS) is an IBM program that is available on selected IBM Commercial PC products. IWS allows customers who travel or need to move products to another country to register the products with IBM's International Warranty Service Office (IWSO). Upon registering the product with the IWSO, IBM will issue a certificate that that will be honored wherever IBM or IBM resellers sell and service IBM Commercial PC products. The IWS program is not available for Aptiva products. .

# Chapter 7

## Adding and removing hardware

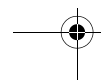
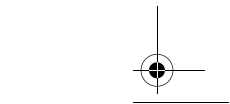
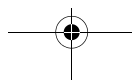
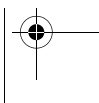
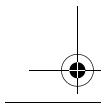
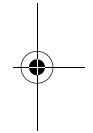
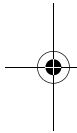
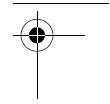
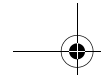
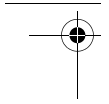



# Adding and removing hardware



## Danger!

*Electrical current from power, telephone, and communications cables is hazardous. To avoid shock hazard, use the steps described in this section to disconnect cables when installing, moving, or opening the cover of this product.*

This chapter contains basic information about:

- adding drives, memory, and adapter cards
- identifying system board components
- replacing the battery.

These instructions do not contain complete information about each option you can install in or remove from your computer. Also, these instructions do not imply whether the drive bays in your model are empty or populated at the factory.

---

## Preparing to work with the computer



## Danger!

*To avoid shock hazard, do not connect or disconnect any cables or perform installation, maintenance, or reconfiguration of this product during an electrical storm.*

Before you make any changes to hardware in your computer, you must turn off and unplug the computer.

### To disconnect

- 1** Turn off the computer and any attached devices that have their own power switches.
- 2** Unplug all power cables from electrical outlets.
- 3** Disconnect all communication cables (such as modem or network cables) from communication outlets.
- 4** Disconnect all cables and cords from the computer; this includes power cords, signal cables from external devices, communication cables, and any other cables attached to the computer.

## Removing and replacing the cover



### Note

*If you have trouble releasing the lock, make sure that the cover is pushed all the way back.*

### Removing the cover:

- 1 Release the lock that secures the cover at the back of the machine by pressing it toward the “unlocked” icon.
- 2 Slip your hand underneath the front panel, reach for the handle, and pull it to fully release the cover.
- 3 Slide the cover forward to remove it completely. The cover slides along the grooves that run on the sides of the system unit.

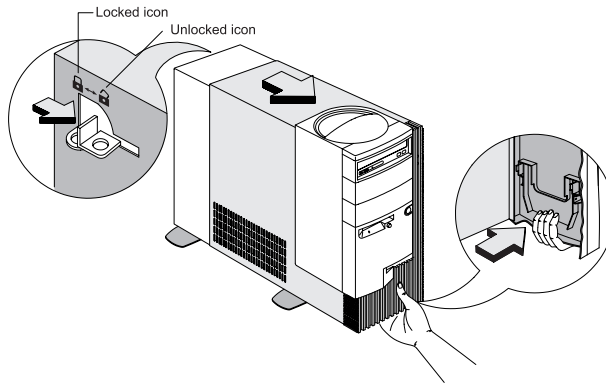

- 4 Touch an unpainted, metal portion of the chassis before touching any internal components.
- 5 While you are working inside the system unit, periodically touch an unpainted, metal portion of the chassis to minimize the chance of damage to the components by static electricity.

# Adding and removing hardware

## Replacing the cover:

- 1 Align the upper corners of the cover with the upper front corners of the chassis. Tilt the cover up about an inch.
- 2 Align the lower back corners of the cover with the lower front corners of the chassis. This ensures that the rails of the chassis slide along the grooves on the sides of the cover.

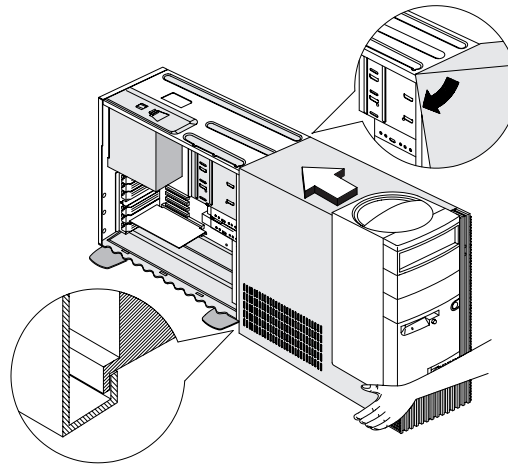

- 3 Slide the cover back until it fits in place. If the cover does not slide all the way to the back, hold the upper back corners of the cover. Gently press them inward while pushing the cover toward the back of the chassis.

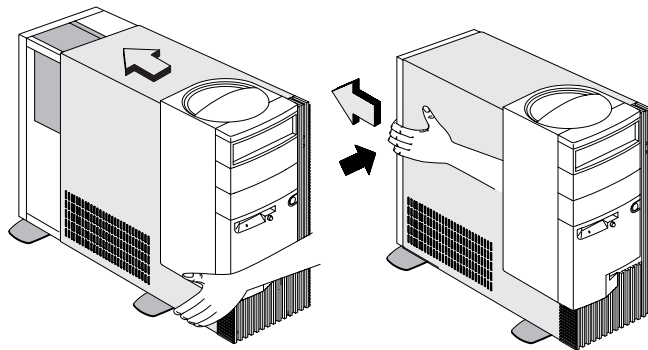

- 4 Turn the lock at the back of the system unit toward the "locked" icon to secure the cover to the chassis.

# Adding and removing hardware

## Adding and removing drives

### To install a drive in the upper drive bay:

- 1 Turn off the computer.
- 2 Remove the system cover.
- 3 Push back the metal bay cover to a 90-degree angle.

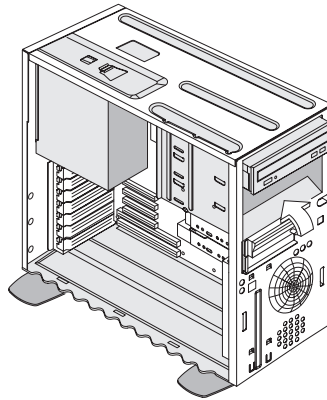

- 4 Insert the drive into the bay.
- 5 Align the screw holes and secure the drive with four screws.

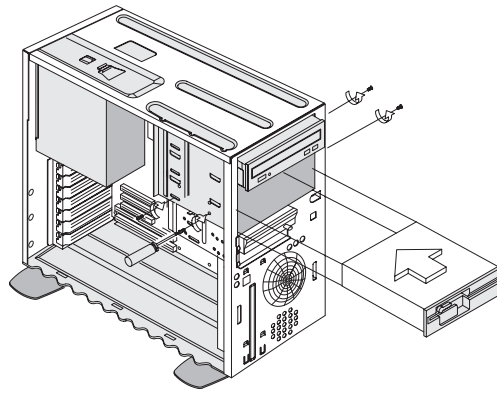

**6** Connect the power and signal cables.

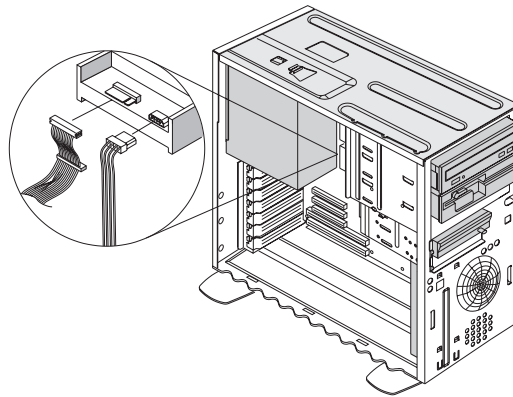

**7** If the drive you are installing needs external access for inserting storage media, then remove the bay panel from the front of the drive bay you plan to use.

- a** Press the latch on the inner right side of a bay panel and pull it out an inch to release the right side of the panel.

# Adding and removing hardware

- b Use both hands to pull the bay panel and remove it completely from the front panel.



## Attention

*Be careful when performing this step to avoid breaking the latches and tabs on the bay panel. DO NOT force the panel out.*

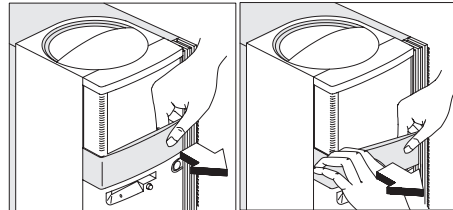

- 8 Reinstall the cover and reconnect the cables to the back of the system unit. Then, reconnect the power cord to the back of the system unit and plug the other end of the cord into a properly grounded electrical outlet.

## To install a drive in the lower drive bay:

- 1 Disconnect the cables from the existing drive.
- 2 Remove the 3.5-inch drive bay from the housing by pressing the tab on top and pivoting the drive bay outward.



## Note

*Write down the original location of the drive power and signal cables. You will need this information when you reinstall the drive.*

*The lowest drive bay can only be used for a drive that does not require external access, such as a slim hard disk.*

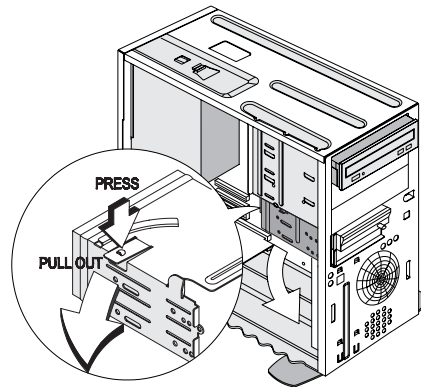

 **Note**

*When installing drives in the lower drive bay, the hard disk drive is always below the 3.5-inch diskette drive.*

- 3** From the back of the drive bay, carefully insert a 3.5-inch disk drive then secure it with four screws on the sides.

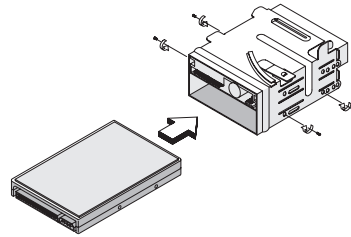

- 4** Reinstall the drive bay into the housing as in the following figure:

- a** Align the drive bay with the notch.
- b** Pivot the drive bay toward the housing until the tab clicks into place.

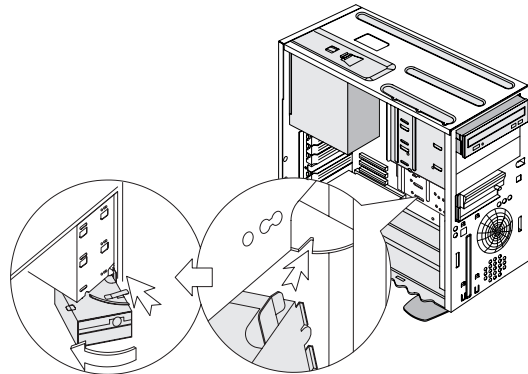



# Adding and removing hardware

- 5 Connect the signal and power cables to the drives.

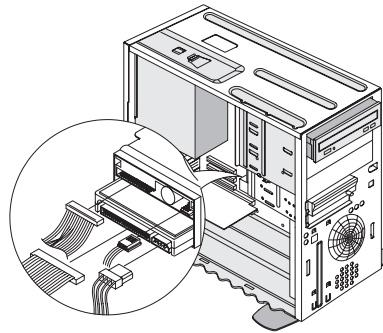

- 6 Reinstall the cover and reconnect the cables to the back of the system unit. Then, reconnect the power cord to the back of the system unit and plug the other end of the cord into a properly grounded electrical outlet.

## To remove the drive:

To remove a drive from a specific bay, reverse the steps for installing a drive in that bay.

---

## Adding and removing adapter cards



### Note

*The computer can accommodate up to 5 PCI adapter cards. The number of unused PCI connectors varies by model.*

### To install an adapter card:

- 1 Turn off the computer.
- 2 Remove the system cover.

- 3 Remove the screw that secures the adapter card slot cover. Then remove the slot cover.

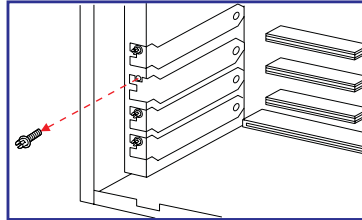

- 4 Align and insert the adapter card into the adapter card connector.
- 5 Secure the card with the screw you removed in Step 3.

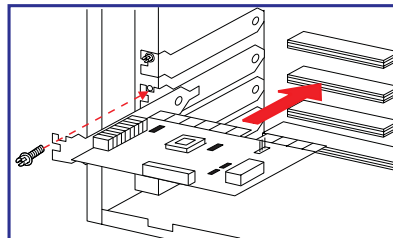

- 6 Except for the original slot cover, reinstall all hardware and screws you removed prior to the installation of the adapter card. Save the original slot cover to use again in case you remove the adapter card.
- 7 If the adapter card came with one or more cables, connect the cables to the correct connectors on the system board or drive. If you disconnected any cables to gain access to the adapter card connector on the system board, reconnect the cables.

# Adding and removing hardware

- 8 Reinstall the cover and reconnect the cables to the back of the system unit. Then, reconnect the power cord to the back of the system unit and plug the other end of the cord into a properly grounded electrical outlet.

If after you turn on your computer you receive a message asking you to insert the Windows CD to search for the required files, then search for these files in the C:\Windows\Options\Cabs directory on your hard drive instead.

## To remove an adapter card:

- 1 Position the system unit so that the card is accessible to you.
- 2 If the adapter card has cables, disconnect them. Be sure to take note of where the cables are connected. You will have to reconnect these cables when you reinstall the card.
- 3 Remove the adapter card screw.
- 4 Firmly hold the adapter card and carefully pull it from the card connector.
- 5 If you are not reinstalling the card, reinstall all hardware and screws you removed prior to the removal of the adapter card.

## Identifying system board components

The system comes with a system board that looks like the figure shown below. This figure is followed by a list of labeled components and their corresponding functions.

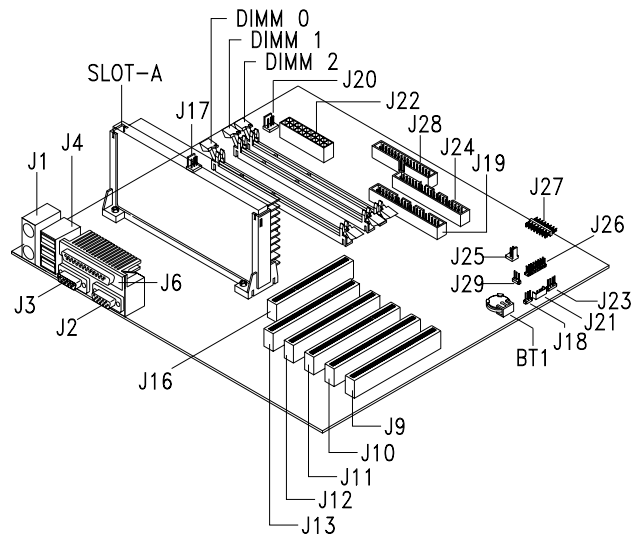

Number	Description	Number	Description
<b>BT1</b>	System battery	<b>J17</b>	Fan connector
<b>DIMM 0, DIMM 1, DIMM 2</b>	System memory module connectors	<b>J19</b>	Secondary IDE connector
<b>J1</b>	PS/2 keyboard and mouse connectors	<b>J20</b>	Power supply fan connector

# Adding and removing hardware

<b>Number</b>	<b>Description</b>	<b>Number</b>	<b>Description</b>
<b>J2</b>	Serial 1 connector	<b>J21</b>	Wake on LAN (WOL) connector
<b>J3</b>	Serial 2 connector	<b>J22</b>	Power connector
<b>J4</b>	USB connectors	<b>J23</b>	Speaker header connector
<b>J6</b>	Parallel connector	<b>J24</b>	Primary IDE connector
<b>J9</b>	PCI connector 0	<b>J25</b>	SCSI LED header connector
<b>J10</b>	PCI connector 1	<b>J26</b>	Front panel connector (HDD LED: pins 1, 3, 5, 7 Power switch: pins 6, 8)
<b>J11</b>	PCI connector 2	<b>J28</b>	Diskette drive connector
<b>J12</b>	PCI connector 3	<b>J29</b>	Power LED connector
<b>J13</b>	PCI connector 4	<b>SLOT-A</b>	Processor connector
<b>J16</b>	AGP video card connector		

## Upgrading the system memory

Your system board has three system memory module sockets: DIMM 0, DIMM 1, and DIMM 2. These sockets hold Dual Inline Memory Modules (DIMMs) that contain 3.3V single- or dual-sided synchronous DRAM (SDRAM). See the system board layout figure page 116 for the location of the sockets on the system board.

You can install up to a maximum of 768 MB of system memory into these sockets.

### To install a DIMM:

- 1 Turn off the computer.
- 2 Remove the system cover.
- 3 Locate the system memory socket where you want to install the memory module.
- 4 Press back the clips on both ends of the socket to open them.

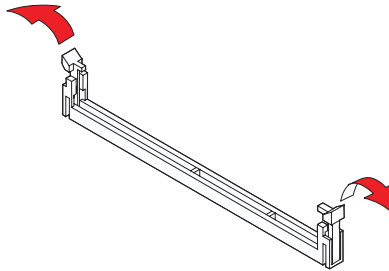

- 5 Insert the memory module by lining up the notches in the base of the module with the notches in the memory module on the system board. Slide the module between the guides on the side of the socket.

## Adding and removing hardware

- 6 Press the memory module into the socket until the clips on both ends click to hold the module in place.

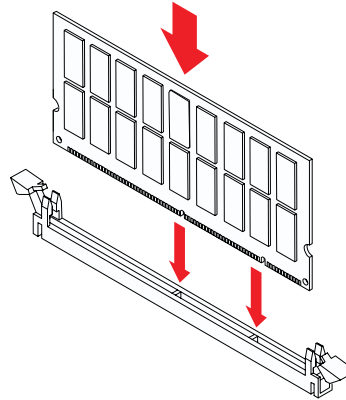

- 7 If you disconnected any cables to gain access to the memory module sockets on the system board, reconnect the cables.
- 8 Reinstall the cover and reconnect the cables to the back of the system unit. Then, reconnect the power cord to the back of the system unit and plug the other end of the cord into a properly grounded electrical outlet.

### To remove a DIMM:

To remove a DIMM, press the holding clips on both sides of the socket outward to release the DIMM.

### To verify the system memory:

To view the system memory settings, enter Setup and select **System Information** from the Setup main menu. See "Starting the Setup Utility" on page 78 for information on how to enter Setup.

## Replacing the system battery

### Caution!

*Your computer uses lithium batteries. There may be a risk of fire, explosion, or burns if the batteries are handled incorrectly. To ensure safety:*

*Do not recharge, disassemble, heat, or incinerate a lithium battery.*

*Replace the battery with an identical or equivalent type lithium battery.*

*Discard used lithium batteries according to local country dispositions.*

Your system battery lets your computer save important system information. Your computer comes with a 3-volt (CR2032) battery. If you replace it, you must use the same type.

Follow these steps to replace the battery:

- 1** Turn off the computer.
- 2** Remove the system cover.
- 3** Locate the battery on the system board. Refer to the board layout figure page 116.
- 4** Look for the "PUSH TAB TO EJECT" mark on the battery holder and firmly press the center tab to release the battery.

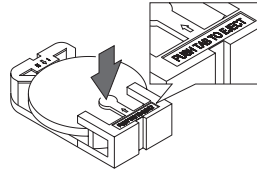

- 5** Lift the battery from the holder with your fingers.
- 6** Slide the new battery into the holder with the "+" side up and then press it down until it clicks into place.

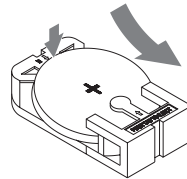

- 7** Discard the old battery according to local regulations.



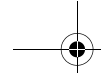

# Adding and removing hardware

When you restart your computer, you will probably get a message that your CMOS has changed. Use the Setup Utility to select **Load Default Settings**. See "Starting the Setup Utility" on page 78 for information on how to enter Setup.

You should also reset the computer's time and date.

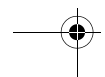
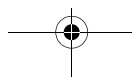
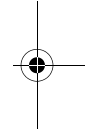
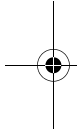

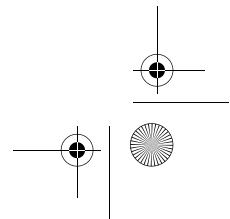
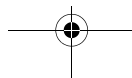
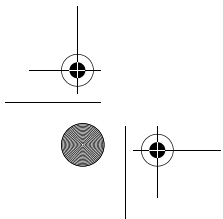
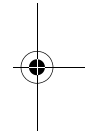
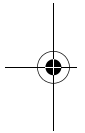
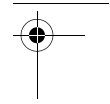
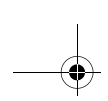
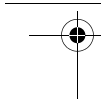

# Appendix A

## Warranties and Notices

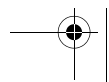
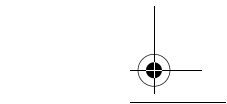
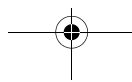
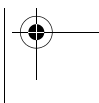
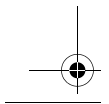
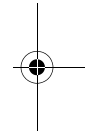
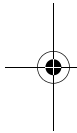
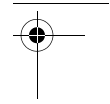
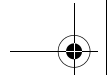
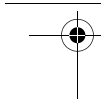

# Warranties and Notices

## Warranty statements

The warranty statements consist of two parts: Part 1 and Part 2. Part 1 varies by country. Part 2 is the same for both statements. Be sure to read both the Part 1 that applies to your country and Part 2.

- **United States, Puerto Rico, and Canada (Z125-4753-05 11/97)** (Part 1 - General Terms on page 125)
- **Worldwide except Canada, Puerto Rico, Turkey, and United States (Z125-5697-01 11/97)** (Part 1 - General Terms on page 130)
- **Worldwide Country-Unique Terms** (Part 2 - Country-Unique Terms on page 135)

### **IBM Statement of Limited Warranty for United States, Puerto Rico, and Canada (Part 1 - General Terms)**

This Statement of Limited Warranty includes Part 1 - General Terms and Part 2 - Country-Unique Terms. **The terms of Part 2 may replace or modify those of Part 1.** The warranties provided by IBM in this Statement of Limited Warranty apply only to Machines you purchase for your use, and not for resale, from IBM or your reseller. The term "Machine" means an IBM machine, its features, conversions, upgrades, elements, or accessories, or any combination of them. The term "Machine" does not include any software programs, whether pre-loaded with the Machine, installed subsequently or otherwise. Unless IBM specifies otherwise, the following warranties apply only in the country where you acquire the Machine. Nothing in this Statement of Warranty

affects any statutory rights of consumers that cannot be waived or limited by contract. If you have any questions, contact IBM or your reseller.

**Machine:** Aptiva Personal Computer  
machine type 2174  
**Warranty Period\*:** Parts: One (1) Year;  
Labor: One (1) Year

\*Contact your place of purchase for warranty service information. Some IBM Machines are eligible for On-site warranty service depending on the country where service is performed.

**The IBM warranty for Machines.** IBM warrants that each Machine 1) is free from defects in materials and workmanship and 2) conforms to IBM's Official Published Specifications. The warranty period for a Machine is a specified, fixed period commencing on its Date of Installation. The date on your sales receipt is the Date of Installation, unless IBM or your reseller informs you otherwise.

During the warranty period IBM or your reseller, if approved by IBM to provide warranty service, will provide repair and exchange service for the Machine, without charge, under the type of service designated for the Machine and will manage and install engineering changes that apply to the Machine.

If a Machine does not function as warranted during the warranty period, and IBM or your reseller are unable to either 1) make it do so or 2) replace it with one that is at least functionality equivalent, you may return it to your place of purchase and your money will be refunded. The replacement may not be new, but will be in good working order.

# Warranties and Notices

## Extent of warranty

The warranty does not cover the repair or exchange of a Machine resulting from misuse, accident, modification, unsuitable physical or operating environment, improper maintenance by you, or failure caused by a product for which IBM is not responsible. The warranty is voided by removal or alteration of Machine or parts identification labels.

**THESE WARRANTIES ARE EXCLUSIVE WARRANTIES AND REPLACE ALL OTHER WARRANTIES OR CONDITIONS, EXPRESS OR IMPLIED, INCLUDING, BUT NOT LIMITED TO, THE IMPLIED WARRANTIES OR CONDITIONS OR MERCHANTABILITY AND FITNESS FOR A PARTICULAR PURPOSE. THESE WARRANTIES GIVE YOU SPECIFIC LEGAL RIGHTS AND YOU MAY ALSO HAVE OTHER RIGHTS WHICH VARY FROM JURISDICTION TO JURISDICTION. SOME JURISDICTIONS DO NOT ALLOW THE EXCLUSION OR LIMITATION OF EXPRESS OR IMPLIED WARRANTIES, SO THE ABOVE EXCLUSION OR LIMITATION MAY NOT APPLY TO YOU. IN THAT EVENT, SUCH WARRANTIES ARE LIMITED IN DURATION TO THE WARRANTY PERIOD. NO WARRANTIES APPLY AFTER THAT PERIOD.**

**Items not covered by warranty.** IBM does not warrant uninterrupted or error-free operation of a Machine.

Unless specified otherwise, IBM provides non-IBM machines **WITHOUT WARRANTIES OF ANY KIND.**

Any technical or other support provided for a Machine under warranty, such as assistance via telephone with "how-to" questions and those regarding Machine set-up and installation, will be provided **WITHOUT WARRANTIES OF ANY KIND.**

**Warranty service.** To obtain warranty service for the Machine, contact your reseller or IBM. In the United States, call IBM at **1-919-517-2800**. In Canada, call IBM at **1-800-565-3344**. You may be required to present proof of purchase.

IBM or your reseller provides certain types of repair and exchange service, either at your location or at a service center, to keep Machines in, or restore them to, conformance with their Specifications. IBM or your reseller will inform you of the available types of service for a Machine based on its country of installation. IBM may repair the failing Machine or exchange it at its discretion.

When warranty service involves the exchange of a Machine or part, the item IBM or your reseller replaces becomes its property and the replacement becomes yours. You represent that all removed items are genuine and unaltered. The replacement may not be new, but will be in good working order and at least functionally equivalent to the item replaced. The replacement assumes the warranty service status of the replaced item.

Any feature, conversion, or upgrade IBM or your reseller services must be installed on a Machine which is 1) for certain Machines, the designated, serial-numbered Machine and 2) at an engineering-change level compatible with the feature, conversion, or upgrade. Many features, conversions, or upgrades involve the removal of parts and their return to IBM. A part that replaces a removed part will assume the warranty service status of the removed part.

Before IBM or your reseller exchanges a Machine or part, you agree to remove all features, parts, options, alterations, and attachments not under warranty service.

You also agree to

- 1** ensure that the Machine is free of any legal obligations or restrictions that prevent its exchange;
- 2** obtain authorization from the owner to have IBM or your reseller service a Machine that you do not own; and



## Warranties and Notices

### 3 where applicable, before service is provided

- a** follow the problem determination, problem analysis, and service request procedures that IBM or your reseller provides,
- b** secure all programs, data, and funds contained in a Machine
- c** provide IBM or your reseller with sufficient, free, and safe access to your facilities to permit them to fulfill their obligations, and
- d** inform IBM or your reseller of changes in a Machine's location.

IBM is responsible for loss of, or damage to, your Machine while it is 1) in IBM's possession or 2) in transit in those cases where IBM is responsible for the transportation charges.

Neither IBM nor your reseller is responsible for any of your confidential, proprietary or personal information contained in a Machine which you return to IBM or your reseller for any reason. You should remove all such information from the Machine prior to its return.

**Production status.** Each IBM Machine is manufactured from new parts, or new and used parts. In some cases, the Machine may not be new and may have been previously installed. Regardless of the Machine's production status, IBM's appropriate warranty terms apply.

**Limitation of liability.** Circumstances may arise where, because of a default on IBM's part of the liability, you are entitled to recover damages from IBM. In each such instance, regardless of the basis on which you are entitled to claim damages from IBM (including fundamental breach, negligence, misrepresentation, or other contract or tort claim), IBM is liable for no more than

- 1 damages for bodily injury (including death) and damage to real property and tangible personal property; and
- 2 the amount of any other actual direct damages, up to the greater of U.S. \$100,000 (or equivalent in local currency) or the charges (if recurring, 12 months' charges apply) for the Machine that is the subject of the claim.

This limit also applies to IBM's suppliers and your reseller. It is the maximum for which IBM, its suppliers, and your reseller are collectively responsible.

**UNDER NO CIRCUMSTANCES IS IBM LIABLE FOR ANY OF THE FOLLOWING: 1) THIRD-PARTY CLAIM AGAINST YOU FOR DAMAGES (OTHER THAN THOSE UNDER THE FIRST ITEM LISTED ABOVE); 2) LOSS OF, OR DAMAGE TO, YOUR RECORDS OR DATA; 3) SPECIAL, INCIDENTAL, OR INDIRECT DAMAGES OR FOR ANY ECONOMIC CONSEQUENTIAL DAMAGES (INCLUDING LOST PROFITS OR SAVINGS), EVEN IF IBM, ITS SUPPLIERS OR YOUR RESELLER IS INFORMED OF THEIR POSSIBILITY. SOME JURISDICTIONS DO NOT ALLOW THE EXCLUSION OR LIMITATION OF INCIDENTAL OR CONSEQUENTIAL DAMAGES, SO THE ABOVE LIMITATION OR EXCLUSION MAY NOT APPLY TO YOU.**

### **IBM Statement of Warranty Worldwide except Canada, Puerto Rico, Turkey, United States (Part 1- General Terms)**

This Statement of Warranty includes Part 1 - General Terms and Part 2 - Country-Unique Terms. **The terms of Part 2 may replace or modify those of Part 1.** The warranties provided by IBM in this Statement of Warranty apply only to Machines you purchase for your use, and not for resale, from IBM or your reseller. The term "Machine" means an IBM machine, its features, conversions, upgrades, elements or accessories, or any combination

## Warranties and Notices

of them. The term "Machine" does not include any software programs, whether pre-loaded with the Machine, installed subsequently or otherwise. Unless IBM specifies otherwise, the following warranties apply only in the country where you acquire the Machine. Nothing in this Statement of Warranty affects any statutory rights of consumers that cannot be waived or limited by contract. If you have any questions, contact IBM or your reseller.

**Machine:** Aptiva Personal Computer  
machine type 2174

**Warranty Period\*:** Parts: One (1) Year;  
Labor: One (1) Year

\*Contact your place of purchase for warranty service information. Some IBM Machines are eligible for On-site warranty service depending on the country where service is performed.

**The IBM warranty for Machines.** IBM warrants that each Machine 1) is free from defects in materials and workmanship and 2) conforms to IBM's Official Published Specifications. The warranty period for a Machine is a specified, fixed period commencing on its Date of Installation. The date on your sales receipt is the Date of Installation, unless IBM or your reseller informs you otherwise.

During the warranty period IBM or your reseller, if approved by IBM to provide warranty service, will provide repair and exchange service for the Machine, without charge, under the type of service designated for the Machine and will manage and install engineering changes that apply to the Machine.

If a Machine does not function as warranted during the warranty period, and IBM or your reseller are unable to either 1) make it do so or 2) replace it with one that is at

least functionality equivalent, you may return it to your place of purchase and your money will be refunded. The replacement may not be new, but will be in good working order.

**Extent of warranty.** The warranty does not cover the repair or exchange of a Machine resulting from misuse, accident, modification, unsuitable physical or operating environment, improper maintenance by you, or failure caused by a product for which IBM is not responsible. The warranty is voided by removal or alteration of Machine or parts identification labels.

**THESE WARRANTIES ARE EXCLUSIVE WARRANTIES AND REPLACE ALL OTHER WARRANTIES OR CONDITIONS, EXPRESS OR IMPLIED, INCLUDING, BUT NOT LIMITED TO, THE IMPLIED WARRANTIES OR CONDITIONS OR MERCHANTABILITY AND FITNESS FOR A PARTICULAR PURPOSE. THESE WARRANTIES GIVE YOU SPECIFIC LEGAL RIGHTS AND YOU MAY ALSO HAVE OTHER RIGHTS WHICH VARY FROM JURISDICTION TO JURISDICTION. SOME JURISDICTIONS DO NOT ALLOW THE EXCLUSION OR LIMITATION OF EXPRESS OR IMPLIED WARRANTIES, SO THE ABOVE EXCLUSION OR LIMITATION MAY NOT APPLY TO YOU. IN THAT EVENT, SUCH WARRANTIES ARE LIMITED IN DURATION TO THE WARRANTY PERIOD. NO WARRANTIES APPLY AFTER THAT PERIOD.**

**Items not covered by warranty.** IBM does not warrant uninterrupted or error-free operation of a Machine.

Unless specified otherwise, IBM provides non-IBM machines **WITHOUT WARRANTIES OF ANY KIND.**

Any technical or other support provided for a Machine under warranty, such as assistance via telephone with "how-to" questions and those regarding Machine set-up and installation, will be provided **WITHOUT WARRANTIES OF ANY KIND.**

# Warranties and Notices

**Warranty service.** To obtain warranty service for the Machine, contact your reseller or IBM. You may be required to present proof of purchase.

IBM or your reseller provides certain types of repair and exchange service, either at your location or at a service center, to keep Machines in, or restore them to, conformance with their Specifications. IBM or your reseller will inform you of the available types of service for a Machine based on its country of installation. IBM may repair the failing Machine or exchange it at its discretion.

When warranty service involves the exchange of a Machine or part, the item IBM or your reseller replaces becomes its property and the replacement becomes yours. You represent that all removed items are genuine and unaltered. The replacement may not be new, but will be in good working order and at least functionally equivalent to the item replaced. The replacement assumes the warranty service status of the replaced item.

Any feature, conversion, or upgrade IBM or your reseller services must be installed on a Machine which is 1) for certain Machines, the designated, serial-numbered Machine and 2) at an engineering-change level compatible with the feature, conversion, or upgrade. Many features, conversions, or upgrades involve the removal of parts and their return to IBM. A part that replaces a removed part will assume the warranty service status of the removed part.

Before IBM or your reseller exchanges a Machine or part, you agree to remove all features, parts, options, alterations, and attachments not under warranty service.

You also agree to

- 1 ensure that the Machine is free of any legal obligations or restrictions that prevent its exchange;

- 2 obtain authorization from the owner to have IBM or your reseller service a Machine that you do not own; and
- 3 where applicable, before service is provided
  - a follow the problem determination, problem analysis, and service request procedures that IBM or your reseller provides,
  - b secure all programs, data, and funds contained in a Machine
  - c provide IBM or your reseller with sufficient, free, and safe access to your facilities to permit them to fulfill their obligations, and
  - d inform IBM or your reseller of changes in a Machine's location.

IBM is responsible for loss of, or damage to, your Machine while it is 1) in IBM's possession or 2) in transit in those cases where IBM is responsible for the transportation charges.

Neither IBM nor your reseller is responsible for any of your confidential, proprietary or personal information contained in a Machine which you return to IBM or your reseller for any reason. You should remove all such information from the Machine prior to its return.

**Production status.** Each IBM Machine is manufactured from new parts, or new and used parts. In some cases, the Machine may not be new and may have been previously installed. Regardless of the Machine's production status, IBM's appropriate warranty terms apply.

**Limitation of liability.** Circumstances may arise where, because of a default on IBM's part of the liability, you are entitled to recover damages from IBM. In each such instance, regardless of the basis on which you are entitled to claim damages from IBM (including

# Warranties and Notices

fundamental breach, negligence, misrepresentation, or other contract or tort claim), IBM is liable for no more than

- 1 damages for bodily injury (including death) and damage to real property and tangible personal property; and
- 2 the amount of any other actual direct damages, up to the greater of U.S. \$100,000 (or equivalent in local currency) or the charges (if recurring, 12 months' charges apply) for the Machine that is the subject of the claim.

This limit also applies to IBM's suppliers and your reseller. It is the maximum for which IBM, its suppliers, and your reseller are collectively responsible.

**UNDER NO CIRCUMSTANCES IS IBM LIABLE FOR ANY OF THE FOLLOWING: 1) THIRD-PARTY CLAIM AGAINST YOU FOR DAMAGES (OTHER THAN THOSE UNDER THE FIRST ITEM LISTED ABOVE); 2) LOSS OF, OR DAMAGE TO, YOUR RECORDS OR DATA; 3) SPECIAL, INCIDENTAL, OR INDIRECT DAMAGES OR FOR ANY ECONOMIC CONSEQUENTIAL DAMAGES (INCLUDING LOST PROFITS OR SAVINGS), EVEN IF IBM, ITS SUPPLIERS OR YOUR RESELLER IS INFORMED OF THEIR POSSIBILITY. SOME JURISDICTIONS DO NOT ALLOW THE EXCLUSION OR LIMITATION OF INCIDENTAL OR CONSEQUENTIAL DAMAGES, SO THE ABOVE LIMITATION OR EXCLUSION MAY NOT APPLY TO YOU.**

## Part 2 - Country-Unique Terms

### ASIA PACIFIC

**AUSTRALIA: The IBM warranty for Machines.** The following paragraph is added to this Section:

The warranties specified in this Section are in addition to

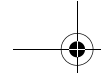

any rights you may have under the Trade Practices Act 1974 or other legislation and are only limited to the extent permitted by the applicable legislation.

**Extent of warranty.** The following replaces the first and second sentences of this Section:

The warranty does not cover the repair or exchange of a Machine resulting from misuse, accident, modification, unsuitable physical or operating environment, operation in other than the Specified Operating Environment, improper maintenance by you, or failure caused by a product for which IBM is not responsible.

**Limitation of liability.** The following is added to this Section:

Where IBM is in breach of a condition or warranty implied by the Trade Practices Act 1974, IBM's liability is limited to the repair or replacement of the goods or the supply of equivalent goods. Where that condition or warranty relates to right to sell, quiet possession or clear title, or the goods are of a kind ordinarily acquired for personal, domestic or household use or consumption, then none of the limitations in this paragraph apply.

**PEOPLE'S REPUBLIC OF CHINA: Governing Law.** The following is added to this Statement:

The laws of the State of New York govern this Statement.

**INDIA: Limitation of liability.** The following replaces items 1 and 2 of this Section:

- 1 liability for bodily injury (including death) or damage to real property and tangible personal property will be limited to that caused by IBM's negligence;
- 2 as to any other actual damage arising in any situation involving nonperformance by IBM pursuant to, or in any way related to the subject of this Statement of

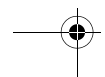
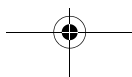
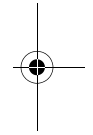
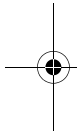



## Warranties and Notices

Warranty, IBM's liability will be limited to the charge paid by you for the individual Machine that is subject of the claim.

**NEW ZEALAND: The IBM warranty for Machines.** The following paragraph is added to this Section:

The warranties specified in this Section are in addition to any rights you may have under the Consumer Guarantees Act 1993 or other legislation which cannot be excluded or limited. The Consumer Guarantees Act 1993 will not apply in respect of any goods which IBM provides, if you require the goods for the purposes of a business as defined in that Act.

**Limitation of liability.** The following is added to this Section:

Where Machines are not acquired for the purposes of a business as defined in the Consumer Guarantees Act 1993, the limitations in this Section are subject to the limitations in that Act.

### EUROPE, MIDDLE EAST, AFRICA (EMEA)

**The following terms apply to all EMEA countries.** The terms of this Statement of Warranty apply to Machines purchased from an IBM reseller. If you purchased this machine from IBM, the terms and conditions of the applicable IBM agreement prevail over this warranty statement.

**Warranty service.** If you purchased an IBM Machine in Austria, Belgium, Denmark, Estonia, Finland, France, Germany, Greece, Iceland, Ireland, Italy, Latvia, Lithuania, Luxembourg, Netherlands, Norway, Portugal, Spain, Sweden, Switzerland or United Kingdom, you may obtain warranty service for that Machine in any of those countries from either (1) an IBM reseller approved to perform warranty service or (2) from IBM.

If you purchased an IBM Personal Computer Machine in Albania, Armenia, Belarus, Bosnia and Herzegovina, Bulgaria, Croatia, Czech Republic, Georgia, Hungary,

Kazakhstan, Kirghizia, Federal Republic of Yugoslavia, Former Yugoslav Republic of Macedonia (FYROM), Moldova, Poland, Romania, Russia, Slovak Republic, Slovenia, or Ukraine, you may obtain warranty service for that Machine in any of those countries from either (1) an IBM reseller approved to perform warranty service or (2) from IBM.

The applicable laws, Country-unique terms and competent court for this Statement are those of the country in which the warranty service is being provided. However, the laws of Austria govern this Statement if the warranty service is provided in Albania, Armenia, Belarus, Bosnia and Herzegovina, Bulgaria, Croatia, Czech Republic, Federal Republic of Yugoslavia, Georgia, Hungary, Kazakhstan, Kirghizia, Former Yugoslav Republic of Macedonia (FYROM), Moldova, Poland, Romania, Russia, Slovak Republic, Slovenia, and Ukraine.

**The following terms apply to the country specified:**

**EGYPT: Limitation of liability.** The following replaces item 2 in this Section:

2. as to any other actual direct damages, IBM's liability will be limited to the total amount you paid for the Machine that is the subject of the claim.

Applicability of suppliers and resellers (unchanged).

**FRANCE: Limitation of liability.** The following replaces the second sentence of the first paragraph of this Section: In such instances, regardless of the basis on which you are entitled to claim damages from IBM, IBM is liable for no more than: (items 1 and 2 unchanged).

**GERMANY: The IBM warranty for Machines.** The following replaces the first sentence of the first paragraph of this Section:

The warranty for an IBM Machine covers the functionality of the Machine for its normal use and the Machine's conformity to its Specifications.

## Warranties and Notices

The following paragraphs are added to this Section:  
The minimum warranty period for Machines is six months.

In case IBM or your reseller are unable to repair an IBM Machine, you can alternatively ask for a partial refund as far as justified by the reduced value of the unrepaired Machine or ask for a cancellation of the respective agreement for such Machine and get your money refunded.

**Extent of warranty: The second paragraph does not apply.**

**Warranty service.** The following is added to this Section:  
During the warranty period, transportation for delivery of the failing Machine to IBM will be at IBM's expense.

**Production status.** The following paragraph replaces this Section:

Each Machine is newly manufactured. It may incorporate in addition to new parts, re-used parts as well.

**Limitation of liability.** The following is added to this Section:

The limitations and exclusions specified in the Statement of Warranty will not apply to damages caused by IBM with fraud or gross negligence and for express warranty.

In item 2, replace "U.S. \$100,000" with "1.000.000 DEM."

The following sentence is added to the end of the first paragraph of item 2:

IBM's liability under this item is limited to the violation of essential contractual terms in cases of ordinary negligence.

**IRELAND: Extent of warranty.** The following is added to this Section:

Except as expressly provided in these terms and conditions, all statutory conditions, including all

warranties implied, but without prejudice to the generality of the foregoing all warranties implied by the Sale of Goods Act 1893 or the Sale of Goods and Supply of Services Act 1980 are hereby excluded.

**Limitation of liability.** The following replaces items one and two of the first para-graph of this Section:

- 1** death or personal injury or physical damage to your real property solely caused by IBM's negligence; and
- 2** the amount of any other actual direct damages, up to the greater of Irish Pounds 75,000 or 125 percent of the charges (if recurring, the 12 months' charges apply) for the Machine that is the subject of the claim or which otherwise gives rise to the claim.

Applicability of suppliers and resellers (unchanged).

The following paragraph is added at the end of this Section:

IBM's entire liability and your sole remedy, whether in contract or in tort, in respect of any default shall be limited to damages.

**ITALY: Limitation of liability.** The following replaces the second sentence in the first paragraph:

In each such instance unless otherwise provided by mandatory law, IBM is liable for no more than: (item 1 unchanged) 2)as to any other actual damage arising in all situations involving nonperformance by IBM pursuant to, or in any way related to the subject matter of this Statement of Warranty, IBM's liability, will be limited to the total amount you paid for the Machine that is the subject of the claim.

Applicability of suppliers and resellers (unchanged).

The following replaces the second paragraph of this Section:

Unless otherwise provided by mandatory law, IBM and

## Warranties and Notices

your reseller are not liable for any of the following:  
(items 1 and 2 unchanged) 3) indirect damages, even if  
IBM or your reseller is informed of their possibility.

**SOUTH AFRICA, NAMIBIA, BOTSWANA, LESOTHO AND  
SWAZILAND: Limitation of liability.** The following is added  
to this Section:

IBM's entire liability to you for actual damages arising in  
all situations involving nonperformance by IBM in  
respect of the subject matter of this Statement of  
Warranty will be limited to the charge paid by you for  
the individual Machine that is the subject of your claim  
from IBM.

**TURKIYE: Production status.** The following replaces this  
Section: IBM fulfils customer orders for IBM Machines  
as newly manufactured in accordance with IBM's  
production standards.

**UNITED KINGDOM: Limitation of liability.** The following  
replaces items 1 and 2 of the first paragraph of this  
Section:

- 1** death or personal injury or physical damage to your  
real property solely caused by IBM's negligence;
- 2** the amount of any other actual direct damages or  
loss, up to the greater of Pounds Sterling 150,000 or  
125 percent of the charges (if recurring, the 12  
months' charges apply) for the Machine that is the  
subject of the claim or which otherwise gives rise to  
the claim.

The following item is added to this paragraph:

- 3** breach of IBM's obligations implied by Section 12 of  
the Sale of Goods Act 1979 or Section 2 of the Supply  
of Goods and Services Act 1982.

Applicability of suppliers and resellers (unchanged).

The following is added to the end of this Section:  
IBM's entire liability and your sole remedy, whether in contract or in tort, in respect of any default will be limited to damages.

#### **NORTH AMERICA**

**CANADA: Warranty service.** The following is added to this Section:

To obtain warranty service from IBM, call **1-800-565-3344**.

**UNITED STATES OF AMERICA: Warranty service.** The following is added to this Section:

To obtain warranty service from IBM, call **1-919-517-2800**.

---

## **Notices**

References in this publication to IBM products, programs, or services do not imply that IBM intends to make these available in all countries in which IBM operates. Any reference to an IBM product, program, or service is not intended to state or imply that only IBM's product, program, or service may be used. Any functionally equivalent product, program, or service that does not infringe any of IBM's intellectual property rights may be used instead of the IBM product, program, or service. Evaluation and verification of operation in conjunction with other products, except those expressly designated by IBM, are the user's responsibility.

IBM may have patents or pending patent applications covering subject matter in this document. The furnishing of this document does not give you any license to these patents. You can send license inquiries, in writing, to the IBM Director of Licensing, IBM Corporation, 500 Columbus Avenue, Thornwood, NY 10594.

# Warranties and Notices

## Non-IBM Web Sites

IBM makes no representations whatsoever about any non-IBM Web site. When you access a non-IBM Web site, please understand that it is independent from IBM, and that IBM has no control over the content on that Web site. In addition, a reference to a non-IBM Web site does not mean that IBM endorses or accepts any responsibility for the content, or the use, of such Web site. It is up to you to take precautions to ensure that whatever you select for your use is free of such items as viruses, worms, trojan horses and other items of a destructive nature. IN NO EVENT WILL IBM BE LIABLE TO ANY PARTY FOR ANY DIRECT, INDIRECT, SPECIAL OR OTHER CONSEQUENTIAL DAMAGES FOR ANY USE OF ANY OTHER WEB SITE, INCLUDING, WITHOUT LIMITATION, ANY LOST PROFITS, BUSINESS INTERRUPTION, LOSS OF PROGRAMS OR OTHER DATA ON YOUR INFORMATION HANDLING SYSTEM OR OTHERWISE, EVEN IF WE ARE EXPRESSLY ADVISED OF THE POSSIBILITY OF SUCH DAMAGES.

## Home PNA Network Card (select models)

If your IBM Aptiva PC has a built-in home PNA networking adapter, the following statements apply:

Actual network transfer speeds depend on many factors, such as home wiring configuration, and are often less than the maximum possible.

Some ISP accounts do not allow or charge extra for Internet sharing. Your ISP access agreement may require you to have more than one account. Check your ISP access agreement for more information.

## Trademarks

The following terms are trademarks or registered trademarks of the IBM Corporation in the United States or other countries or both:

- Aptiva
- Rapid Access
- ScrollPoint
- HelpCenter
- HelpWare
- Wake on LAN
- IBM

Other company, product, and service names may be trademarks or service marks of others.

Microsoft and the Windows logo are trademarks or registered trademarks of Microsoft Corporation.

## Regulatory notices

### North American FCC and telephone company requirements .

If your IBM Aptiva PC has a built-in modem, the following Federal Communications Commission (FCC) and telephone company requirements apply:

- 1 The modem adapter card is located in the back of the system unit. It complies with Part 68 of the FCC rules. A label is affixed to the built-in modem that contains, among other things, the FCC registration number, USOC, and Ringer Equivalency Number (REN) for this equipment. If these numbers are requested, refer to "Removing and replacing the cover" on page 106 for instructions on how to open the system unit to see the label and provide this information to your telephone company.



## Warranties and Notices

- 2** The REN is useful to determine the quantity of devices you may connect to your telephone line and still have those devices ring when your number is called. In most, but not all areas, the sum of the REN of all devices should not exceed five (5.0). To be certain of the number of devices you may connect to your line, as determined by the REN, you should call your local telephone company to determine the maximum REN for your calling area.
- 3** If the built-in modem causes harm to the telephone network, the telephone company may discontinue your service temporarily. If possible, they may notify you in advance; if advance notice isn't practical, you may be notified as soon as possible. You may be advised of your right to file a complaint with the FCC.
- 4** Your telephone company may make changes in its facilities, equipment, operations, or procedures that could affect the proper operation of your equipment. If they do, you may be given advance notice so as to give you an opportunity to maintain uninterrupted service.
- 5** If you experience trouble with this built-in modem, contact your Authorized Seller, or the IBM HelpCenter – Aptiva PC, IBM Corporation, 3039 Cornwallis Rd., Bldg. 203, Research Triangle Park, NC 27709-2195 1-919-517-2800, for repair/warranty information. The telephone company may ask you to disconnect this equipment from the network until the problem has been corrected, or until you are sure the equipment is not malfunctioning.
- 6** No customer repairs are possible to the modem.
- 7** The modem may not be used on coin service provided by the telephone company. Connection to party lines is subject to state tariffs. Contact your state public utility commission or corporation commission for information.

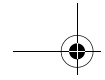

- 8 When ordering network interface (NI) service from the Local Exchange Carrier, specify service arrangement USOC RJ11C.

**North American Federal Communications Commission (FCC) statement.** *IBM Aptiva PC 2174.* The following statement applies to this IBM product. The statement for other IBM products intended for use with this product will appear in their accompanying manuals.

This equipment has been tested and found to comply with the limits for a Class B digital device, pursuant to Part 15 of the FCC Rules. These limits are designed to provide reasonable protection against harmful interference in a residential installation. This equipment generates, uses, and can radiate radio frequency energy and, if not installed and used in accordance with the instructions, may cause harmful interference to radio communications. However, there is no guarantee that interference will not occur in a particular installation. If this equipment does cause harmful interference to radio or television reception, which can be determined by turning the equipment off and on, the user is encouraged to try to correct the interference by one or more of the following measures:

- Reorient or relocate the receiving antenna.
- Increase the separation between the equipment and receiver.
- Connect the equipment into an outlet on a circuit different from that to which the receiver is connected.
- Consult an IBM authorized dealer or service representative for help.

Properly shielded and grounded cables and connectors must be used in order to meet FCC emission limits. Proper cables and connectors are available from IBM authorized dealers. IBM is not responsible for any radio

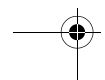
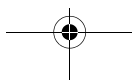
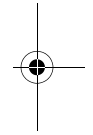
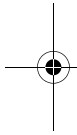

## Warranties and Notices

or television interference caused by using other than recommended cables and connectors or by unauthorized changes or modifications to this equipment. Unauthorized changes or modifications could void the user's authority to operate the equipment.

This device complies with Part 15 of the FCC Rules. Operation is subject to the following two conditions: (1) this device may not cause harmful interference, and (2) this device must accept any interference received, including interference that may cause undesired operation.

Responsible Party:

International Business Machines Corporation  
New Orchard Road  
Armonk, NY 10504  
Telephone: 1-919-543-2193

**FC** Tested To Comply  
With FCC Standards  
FOR HOME OR OFFICE USE

This Class B digital apparatus meets all requirements of the Canadian Interference-Causing Equipment Regulations.

Cet appareil numérique de classe B est conforme la norme NMB-003 du Canada.

**European Community Directive Conformance statement.** This product is in conformity with the protection requirements of EU Council Directive 89/336/EEC on the approximation of the laws of the Member States relating to electromagnetic compatibility.

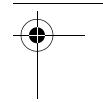
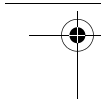
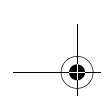

IBM cannot accept responsibility for any failure to satisfy the protection requirements resulting from a non-recommended modification of the product, including the fitting of non-IBM option cards.

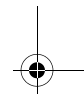
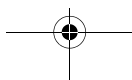
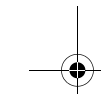
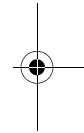
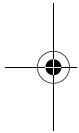

# Index

## A

- adapter cards 113
  - installing 113
  - removing 115
- adding and removing hardware 105
- Aptiva Help 24–28
- arrange work area 15
- audio
  - solving problems 43, 56
- AutoPlay 27, 43

## B

- batteries 6, 120
- battery
  - disposal 6, 120
  - handling 6, 120
- BIOS
  - Setup Utility updates 77

## C

- CD-ROM
  - handling discs 27
- CD-ROM drive
  - audio disc
    - problems 43, 56
  - safety information 7
  - where to find. See "Hardware" topics in Aptiva Help
- consignes de sécurité 9

- branchement de l'ordinateur 10
- connexion téléphonique 9
- pièces de rechange 9
- produit à laser 11
- protection contre les risques d'électrocution 9
- unité de DVD-ROM 11–12
- unités de CD-ROM et de DVD-ROM 11–12
- contact IBM HelpCenter 92

## D

- Diagnosing 31
- diagnosing problems. See topic in Aptiva Help
- DVD 27
  - solving problems 60

## E

- ergonomics 15, 17
  - chair 16
  - keyboard position 17
  - monitor position 16
  - mouse position 17
- error codes 61–70

- express maintenance 102

## G

- getting help 102

## H

- handling CDs and DVDs 27
- hardware
  - adding and removing 105–121
  - configuration 77
  - solving hardware problems 39
  - specifications. See "System Information" topic in Aptiva Help
  - testing. See "diagnosing problems"
- hardware problems
  - HelpWare service and support 87–102
- help 87
  - 30-day "Up and Running" support 93
  - Aptiva Help 25–26
  - electronic 89
  - hardware 93
  - Internet 87
  - readme files 26
  - software 93

telephone 87, 92  
troubleshooting steps 72  
HelpWare 87–102  
30-day "Up and Running" support 93  
additional support 93  
automated fax 92  
definition 102  
electronic support 89  
hardware service 93  
online documentation 88  
printed documentation 88  
purchasing additional services 98  
quick help 87  
software support 93  
How Do I... 24

**I**

IBM ScrollPoint II mouse 22  
buttons 22  
using 22  
information  
readme files 26  
installing programs 27–28

Internet 87

**K**

keyboard  
positioning 17  
solving problems 44

**L**

laser product safety information 7

**M**

mise à la terre de l'ordinateur 9  
modem  
solving problems 56  
monitor  
positioning 16  
solving problems 53  
multimedia  
solving problems 56–59

**N**

Norton AntiVirus 28  
notices 142

**O**

online information  
Aptiva Help

readme files 25  
online information and software  
handling CDs and DVDs 27  
installing programs 27

**P**

power button switch 34  
power button. See "Getting Started" topics in Aptiva Help  
problems  
audio, multimedia, and modem 56–59  
can't use second modem 59  
modem not detected 58  
no modem dial tone 59  
no sound 56  
beeps 39  
diagnosing 31  
DVD 60  
error codes 61–70  
hardware 39–48  
blank screen 39  
computer appears to have turned off without warning 39  
drives 40–43

# Index

- error code 39
  - keyboard 44
  - modem 46
  - mouse 45
  - printer 47
  - monitor 53–55
    - adjustments 55
    - blank screen 55
    - cursor only
      - displayed 55
    - discolored
      - screen 53
    - flicker 54
    - fonts 54
    - no cursor 55
    - poor picture
      - shape 53
    - unreadable
      - screen 55
    - unsteady
      - picture 54
    - white screen 54
    - yellow, cyan, magenta
      - screen 54
  - questions to ask
    - first 34
    - beeps 35, 48
    - monitor 36–38
    - power lights 34
  - recovering factory
    - installed programs and files 71
  - software 49–51
    - computer doesn't
      - turn off 52
    - suspend 49, 50
    - troubleshooting
      - steps 34–72
  - produits à laser
    - consignes de sécurité 11
- R**
- Rapid Access keyboard 21
    - using 21
  - Readme files 26
  - recovering factory installed programs 71
  - regulatory notices 144
    - EU conformance statement 147
    - FCC and telephone company 144
    - FCC statement 146
  - replacement parts safety information 5
- S**
- safety information 5–8
    - CD-ROM and DVD-ROM drive 7–8
  - connecting your computer 6
  - DVD-ROM drive 7–8
  - grounding your computer 5
  - laser product 7
  - lithium batteries
    - 6, 120
  - protecting against electrical shock 5
  - replacement parts 5
  - telephone
    - connection 5
  - service and support 102
  - setting up your
    - computer 15–17
      - chair 16
      - keyboard position 17
      - monitor position 16
      - mouse position 17
  - Setup Utility 77–84
    - changing settings 82
    - exiting 83
    - loading default 82
    - Main Menu 80
    - starting 78
    - using 77
    - viewing system information 82
    - working with 81
  - software
    - installing
      - programs 27
    - solving problems 49
  - support 102
    - electronic 89
    - Internet 87
    - telephone 87, 92
  - system battery
    - replacing 120

system board  
     identifying  
         components 116  
         –117  
 system information. See topic  
     in Aptiva Help  
 system memory  
     install DIMM 118  
     removing DIMM 119  
     upgrading 117  
     verifying 119

## T

telephone support 87, 92  
 trademarks 144  
 troubleshooting 34–72  
     audio, multimedia, and  
     modem  
     problems 56–59  
     can't use second  
     modem 59  
     modem not  
     detected 58  
     no modem dial  
     tone 59  
     no sound 56  
     diagnosing and  
     recovering from  
     problems 31  
     DVD problems 60  
     error codes 61–70  
         111 I/O parity  
         error 61

1162 onboard  
     serial port  
     conflict(s) 65  
 127 CPU clock  
     mismatch 61  
 151/163 real time  
     clock  
     error 61  
 161 CMOS battery  
     bad 62  
 162 CMOS  
     checksum  
     error 61, 62  
 162 equipment  
     configuration  
     error 62  
 164 memory size  
     changed 62  
 1755 hard disk  
     drive(s) write  
     protected 65  
 1762 onboard  
     secondary IDE  
     channel I/O  
     address  
     conflict(s) 66  
 178 IDE primary  
     slave drive  
     error 67  
 1780 IDE primary  
     channel  
     master drive  
     error 66  
 1782 IDE  
     secondary  
     channel  
     master drive  
     error 67

1783 IDE  
     secondary  
     channel slave  
     drive  
     error 68  
 1800 IRQ setting  
     error/PnP ISA  
     card(s)  
     disabled 68  
 1801 expansion  
     ROM  
     allocation  
     failed 68  
 1802 I/O resource  
     conflict(s) 69  
 1803 memory  
     resource  
     conflict(s) 69  
 1962 insert system  
     diskette and  
     press to  
     reboot  
     message 70  
 201 memory  
     error 63  
 301 PS/2 keyboard  
     error 63  
 303 PS/2 Keyboard  
     Interface  
     Error 63  
 648 floppy drive(s)  
     write  
     protected 63  
 662 floppy disk  
     controller  
     error 64  
 662 floppy drive  
     error 64



# Index

- 662 onboard floppy drive errors 64
  - 8601/8603 PS/2 pointing device error 70
  - 962 onboard parallel port conflict(s) 65
  - beep 61
  - NMI 61
  - hardware
    - problems 39–48
    - beeps 39
    - blank screen 39
    - computer appears to have turned off without warning 39
    - drives 40–43
    - error code 39
    - keyboard 44
    - modem 46
    - mouse 45
    - printer 47
  - monitor
    - problems 53–55
    - adjustments 55
    - blank screen 55
    - cursor only displayed 55
    - discolored screen 53
    - flicker 54
    - fonts 54
    - no cursor 55
    - poor picture shape 53
    - unreadable screen 55
    - unsteady picture 54
    - white screen 54
    - yellow, cyan, magenta screen 54
  - questions to ask
    - first 34
    - beeps 35, 48
    - monitor 36–38
    - power lights 34
  - recovering factory installed programs and files 71
  - software
    - computer doesn't turn off 52
    - suspend 49, 50
  - software problems 49–51
- U**
- unité de CD-ROM
    - consignes de sécurité 11
    - emplacement.  
Reportez-vous aux sections relatives au matériel de l'aide en ligne Aptiva

Update Connector 28, 89

## W

warranties 123

