

This publication, including all photographs, illustrations and software, is protected under international copyright laws, with all rights reserved. Neither this manual, nor any of the material contained herein, may be reproduced without the express written consent of the manufacturer.

The information in this document is subject to change without notice. The manufacturer makes no representations or warranties with respect to the contents hereof and specifically disclaims any implied warranties of merchantability or fitness for any particular purpose. Further, the manufacturer reserves the right to revise this publication and to make changes from time to time in the content hereof without obligation of the manufacturer to notify any person of such revision or changes.

Trademarks

IBM, VGA, and PS/2 are registered trademarks of International Business Machines.

AMD, Duron and Athlon are registered trademarks of Advanced Micro Devices Inc.

Intel, Pentium/II/III, and MMX are registered trademarks of Intel Corporation.

Microsoft, MS-DOS and Windows 95/98/NT/2000 are registered trademarks of Microsoft Corporation.

PC-cillin and ChipAwayVirus are registered trademarks of Trend Micro Inc.

AMI is a registered trademark of American Megatrends Inc.

ALi is a registered trademark of Acer Laboratories Inc.

Other names used in this publication may be trademarks and are acknowledged.

**Copyright ©2001
All Rights Reserved
K7AMA(ATA133), V1.5
December 2001**

Table of Contents

Trademarks	I
Chapter 1	1
Introduction.....	1
Key Features	2
Package Contents	4
Static Electricity Precautions	5
Pre-Installation Inspection.....	5
Chapter 2	6
Mainboard Installation	6
Mainboard Components.....	7
I/O Ports	7
Install A CPU	8
Install Memory	10
Setting Jumper Switches.....	11
Install the Mainboard	13
Install the Extension Brackets	14
Optional Extension Brackets.....	15
Install Other Devices	16
Expansion Slots	18
Chapter 3	20
BIOS Setup Utility.....	20
Introduction.....	20
Running the Setup Utility	21
Standard CMOS Setup Page	22
Advanced Setup Page.....	23
Power Management Setup Page.....	25
PCI / Plug and Play Setup Page.....	26
Load Optimal Settings	27
Load Best Performance Settings.....	27
Features Setup Page.....	27
CPU PnP Setup Page.....	29
Hardware Monitor Page.....	30
Change Password.....	30
Exit	31
Chapter 4	32
Using the Mainboard Software	32
About the Software CD-ROM	32
Auto-installing under Windows 98.....	33
Manual Installation.....	36
Utility Software Reference.....	36

Chapter 1

Introduction

This mainboard has a **Socket-462** processor socket for an **AMD K7** type CPUs. You can install any one of these processors on the mainboard.

The mainboard supports Socket-462 processor front-side bus speeds of **200MHz** or **266MHz**.

This mainboard uses the **ALI M1645** chipset which supports a **4X AGP** slot for highly graphics display, **DDR** interface and **Ultra DMA 33/66/100/133** function, provides outstanding high system performance under all types of system operations. The mainboard has a built-in **AC97 Codec**, provides an **AMR** (Audio Modem Riser) slot to support Audio and Modem application, and has a built-in **10BaseT/100BaseTX Network Interface** (optional). In addition, the mainboard has an extended set of **ATX I/O Ports** including PS/2 keyboard and mouse ports, two USB ports, a parallel port, and two serial ports. Two extra USB ports can be added using the Extended USB Module that connects to the mainboard.

This mainboard has all the features you need to develop a powerful multimedia workstation that is network ready. The board is **ATX size** and has power connectors for an **ATX** power supply.

Key Features

The key features of this mainboard include:

Socket-462 Processor Support

- ◆ Supports AMD **Athlon/Duron** processors
- ◆ Supports 200/266 MHz Front-Side Bus

Memory Support

- ◆ Two 168-pin DIMM slots for SDRAM memory modules
- ◆ Two 184-pin DIMM slots for DDR memory modules
- ◆ Support for 100/133MHz memory bus
- ◆ Maximum installed memory is 1GB

Note: You cannot use SDRAM and DDR simultaneously.

Expansion Slots

- ◆ One AMR slot for a special audio/modem riser card
- ◆ One AGP4X slot for AGP 2.0-compliant interface
- ◆ Four 32-bit PCI slots for PCI 2.2-compliant bus interface

Onboard IDE channels

- ◆ Primary and Secondary PCI IDE channels
- ◆ Support for PIO (programmable input/output) modes
- ◆ Support for Multiword DMA modes
- ◆ Support for Bus Mastering and Ultra DMA 33/66/100/133 modes

Power Supply and Power Management

- ◆ ATX power supply connector
- ◆ ACPI and previous PMU support, suspend switch, keyboard power on/off
- ◆ Supports Wake on Modem, Wake on LAN and Wake on Alarm

AC' 97 Codec

- ◆ Compliant AC' 97 2.1 specification
- ◆ Supports 18-bit ADC (Analog Digital Converter) and DAC (Digital Analog Converter) as well as 18-bit stereo full-duplex codec

Onboard I/O Ports

- ◆ Provides PC99 Color Connectors for easy peripheral device connections
- ◆ Floppy disk drive connector with 1Mb/s transfer rate
- ◆ Two serial ports with 16550-compatible fast UART
- ◆ One parallel port with ECP and EPP support
- ◆ Two USB ports and optional two USB ports module
- ◆ Two PS/2 ports for keyboard and mouse
- ◆ One infrared port connector for optional module

Hardware Monitoring

- ◆ Built-in hardware monitoring for CPU & System temperatures, fan speeds and mainboard voltages

Built-in Ethernet LAN (optional)

- ◆ Built-in **10BaseT/100BaseTX Ethernet LAN**
- ◆ LAN controller integrates Fast Ethernet MAC and PHY compliant with IEEE802.3u 100BASE-TX, 10BASE-T and ANSI X3.263 TP-PMD standards
- ◆ Compliant with ACPI 1.0 and the Network Device Class Power Management 1.0
- ◆ High Performance provided by 100Mbps clock generator and data recovery circuit for 100Mbps receiver

Onboard Flash ROM

- ◆ Supports Plug and Play configuration of peripheral devices and expansion cards

Dimensions

- ◆ ATX form factor (30.5cm x 22cm)

Package Contents

Your mainboard package ships with the following items:

- The mainboard
- This User's Guide
- 1 UDMA 66/100 IDE cable
- 1 Floppy disk drive cable
- Support software on CD-ROM disk

Optional Accessories

You can purchase the following optional accessories for this mainboard.

- Extended USB module
- 1 LAN module

Static Electricity Precautions

Components on this mainboard can be damaged by static electricity. Take the following precautions when unpacking the mainboard and installing it in a system.

1. Keep the mainboard and other components in their original static-proof packaging until you are ready to install them.
2. During installation, wear a grounded wrist strap if possible. If you don't have a wrist strap, discharge static electricity by touching the bare metal of the system chassis.
3. Handle the mainboard carefully by the edges. Avoid touching the components unless it is absolutely necessary. During installation put the mainboard on top of the static-protection packaging it came in with the component side facing up.

Pre-Installation Inspection

1. Inspect the mainboard for damage to the components and connectors on the board.
2. If you suspect that the mainboard has been damaged, do not connect power to the system. Contact your mainboard vendor and report the damage.

Chapter 2

Mainboard Installation

To install this mainboard in a system, follow the procedures in this chapter:

Identify the mainboard components

Install a CPU

Install one or more system memory modules

Verify that any jumpers or switches are set correctly

Install the mainboard in a system chassis (case)

Connect any extension brackets or cables to the mainboard connector headers

Install any other devices and make the appropriate connections to the mainboard connector headers.

Note:

1. Before installing this mainboard, make sure jumper JP5 set to Normal setting. See this chapter for information on locating JP5 and the setting options.
2. Never connect power to the system during installation. Doing so may damage the mainboard.

Mainboard Components

Use the diagram below to identify the major components on the mainboard.

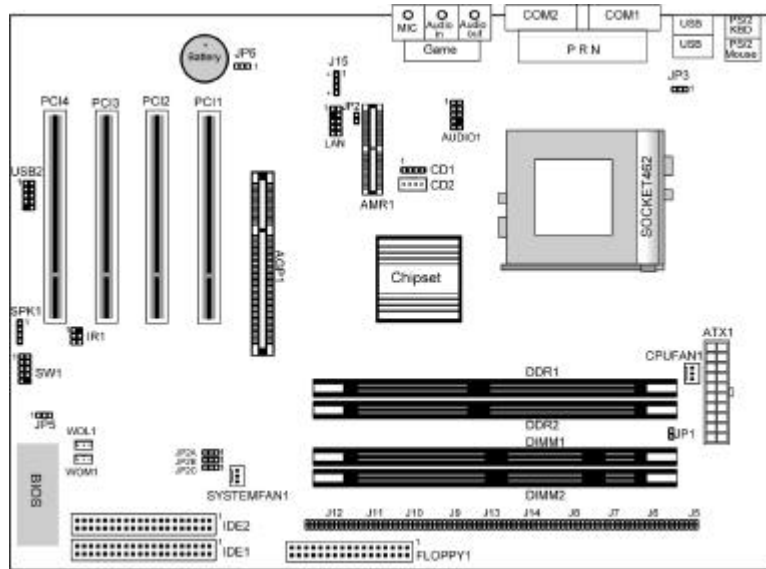

Note: Any jumper on your mainboard that do not appear in the illustration above is for testing only.

I/O Ports

The illustration below shows a side view of the built-in I/O ports on the mainboard.

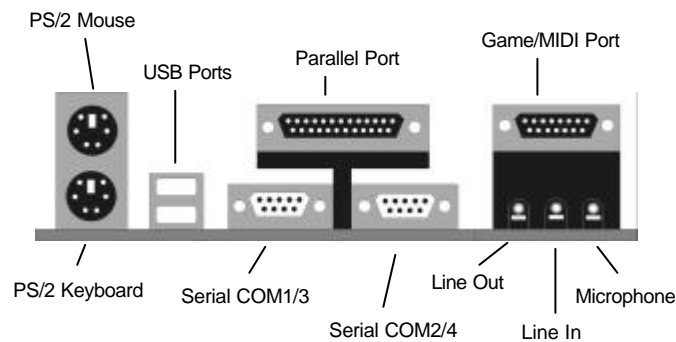

Install A CPU

This mainboard has a Socket-462 CPU socket for AMD K7 processors.

To ensure reliability, ensure that your processor has a heatsink/cooling fan assembly.

Do not try to install a Socket-370/Socket-7 processor in the Socket-462. A Socket-370/Socket-7 processor such as the PPGA Celeron, FCPGA Pentium-III, Pentium-MMX, or the AMD K5/K6 does not fit in the Socket-462.

The following list notes the processors that are currently supported by this mainboard.

Athlon: 700 MHz~1.3 GHz, FSB: 200 MHz, 266 MHz

Duron: 600~950 MHz, FSB: 200 MHz

Installing a Socket-462 Processor

A processor installs into the ZIF (Zero Insertion Force) Socket-462 on the mainboard.

1. Locate the Socket-462 and CPUFAN1. Pull the locking lever out slightly from the socket and raise it to the upright position.

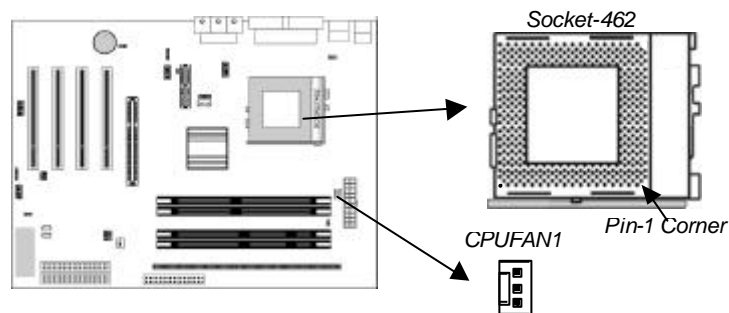

2. On the processor, identify the Pin-1 corner by its beveled edge.
3. On the Socket-462, identify the Pin-1 corner. The Pin-1 corner is at the top of the locking lever when it is locked.

4. Match the Pin-1 corners and insert the processor into the socket. No force is required and the processor should drop into place freely.
5. Swing the locking lever down and hook it under the catch on the side of the socket. This secures the CPU in the socket.
6. All processors should be installed with a combination heatsink/cooling fan (the original fan is recommended, the others' fan is not), connect the cable from the fan to the CPU fan power connector CPUFAN1.

See the Setting Jumper Switches section for detail information on CPU System Bus settings.

Install Memory

The mainboard has two 168-pin/184-pin DIMM sockets for SDRAM/DDR SDRAM (Double Data Rate SDRAM) system memory modules. You must install at least one memory module in order to use the mainboard, and **you can only use one of the both SDRAM and DDR SDRAM at the same time**.

DDR SDRAM provides 800 MBps or 1 GBps data transfer depending on whether the bus is 100 MHz or 133 MHz. It doubles the rate to 1.6 GBps and 2.1 GBps by transferring data on both the rising and falling edges of the clock. DDR SDRAM uses additional power and ground lines and requires 184-pin 2.5V unbuffered DIMM module rather than the 168-pin 3.3V unbuffered DIMMs used by SDRAM.

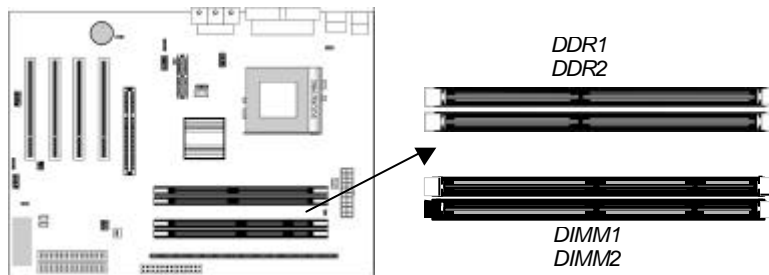

For this mainboard, the maximum memory size is 1GB.

The edge connectors on the memory modules have cut outs, which coincide with spacers in the DIMM sockets so that memory module can only be installed in the correct orientation.

To install a module, push the retaining latches at either end of the socket outwards. Position the memory module correctly and insert it into the DIMM socket. Press the module down into the socket so that the retaining latches rotate up and secure the module in place by fitting into notches on the edge of the module.

The table below lists the model chips of DDR that we have tested.

Model Chip	Manufacture
K4H2808388-TCBO	SAMSUNG
HY5DU2882T-H	HYUNDAI

See the next section for detail information on SDRAM Type and RAM Voltage settings.

Setting Jumper Switches

Jumpers are sets of pins which can be connected together with jumper caps. The jumper caps change the way the mainboard operates by changing the electronic circuits on the mainboard. If a jumper cap connects two pins, we say the pins are **SHORT**. If a jumper cap is removed from two pins, the pins are **OPEN**.

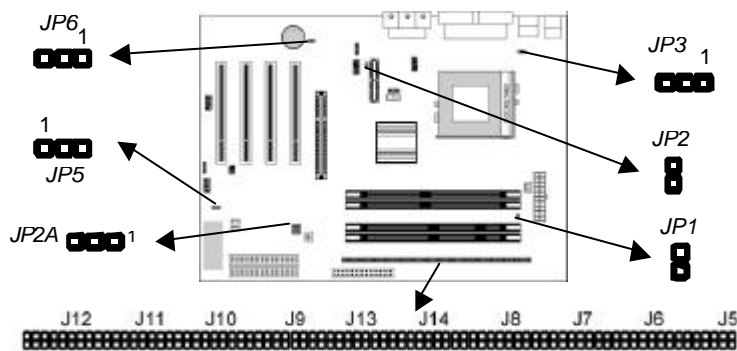

Jumper J5~J14: SDRAM Type Selector

The ten jumpers all consist of eight sets of 2-pin jumpers. Use these jumpers to select the SDRAM type for the system memory.

Function	Jumper Setting
DDR DIMM socket	Short all Pins 1-2
SDRAM DIMM socket	Open all Pins 1-2

Jumper JP1: RAM Voltage Selector

Use this 2-pin jumper to select the voltage for the installed SDRAM module.

Function	Jumper Setting
3.3V for SDRAM	Short Pins 1-2
2.5V for DDR	Open Pins 1-2

Jumper JP2: Codec Selector

Use this jumper to select the onboard audio codec or Audio Modem Riser (AMR) slot.

Function	Jumper Setting
Primary codec onboard	Short Pins 1-2
Primary codec on AMR slot	Open Pins 1-2

Jumper JP2A: CPU System Bus Selector

Use this 3-pin jumper to select if the processor runs on 133 MHz or 100 MHz system bus.

Function	JP2A
133 MHz system bus	Short Pins 1-2
100 MHz system bus	Short Pins 2-3

Jumper JP3: Keyboard Power On Selector

If you enable the keyboard power on feature, you can use hot keys on your keyboard as a power on/off switch for the system.

Note: The system must provide 1A on the +5VSB (+5V Standby) signal before using the Keyboard Power On function.

Function	Jumper Setting
Disable Keyboard Power On	Short Pins 1-2
Enable Keyboard Power On	Short Pins 2-3

Jumper JP5: Clear CMOS Memory

Use this jumper to clear the contents of the CMOS memory. You may need to clear the CMOS memory if the settings in the Setup Utility are incorrect and prevent your mainboard from operating. To clear the CMOS memory, disconnect all the power cables from the mainboard and then move the jumper cap into the CLEAR setting for a few seconds.

Function	Jumper Setting
Normal Operation	Short Pins 1-2
Clear CMOS Memory	Short Pins 2-3

Jumper JP6: Onboard LAN Selector

Use this 3-pin jumper to enable or disable the onboard network adapter.

Function	Jumper Setting
Enable Onboard LAN	Short Pins 1-2
Disable Onboard LAN	Short Pins 2-3

Install the Mainboard

Install the mainboard in a system chassis (case). The board is an ATX size mainboard with a twin-tier of I/O ports. You can install this mainboard in an ATX case. Ensure that your case has an I/O cover plate that matches the ports on this mainboard.

Install the mainboard in a case. Follow the instructions provided by the case manufacturer using the hardware and internal mounting points on the chassis.

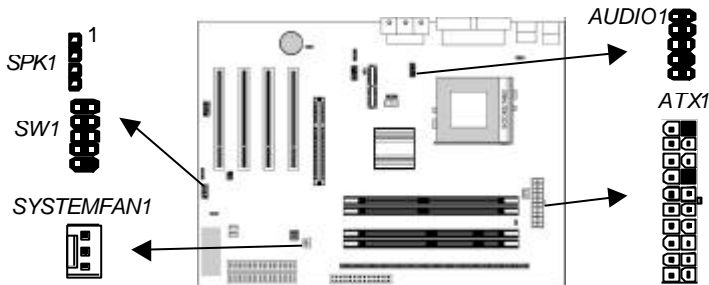

Connect the power connector from the power supply to the **ATX1** connector on the mainboard.

If there is a cooling fan installed in the system chassis, connect the cable from the cooling fan to the **SYSTEMFAN1** fan power connector on the mainboard.

Connect the cable from the PC speaker to the **SPK1** header on the mainboard.

Connect the case switches and indicator LEDs to the **SW1** header. If there are a headphone jack or/and a microphone jack on the front panel, connect the cables to the **AUDIO1** header on the mainboard. See the illustrations below for the guide to the SW1 and AUDIO1 headers pin assignments.

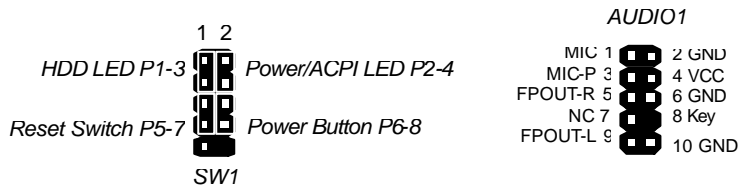

Install the Extension Brackets

The extension brackets are used to connect features on the mainboard to external connectors that can be attached to the system chassis. Follow the steps below to install the extension brackets.

Note: All the ribbon cables used on the extension brackets have a red stripe on the Pin-1 side of the cable.

LAN Adapter Extension Bracket (Optional)

This bracket supports an RJ45 network connector and connects to the built in LAN header on the mainboard.

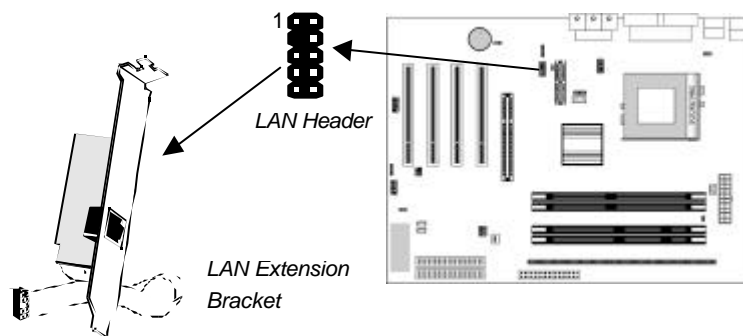

1. On the mainboard, locate the LAN header for this bracket.
2. Plug the cable from the bracket into the LAN header.
3. In the system chassis, remove a blanking plate from one of the expansion slots and install the extension bracket in the slot. Use the screw that held the blanking plate in place to secure the extension bracket.

Optional Extension Brackets

For this mainboard, you can also obtain a USB module extension bracket. Install them by following the steps below.

Note: All the ribbon cables used on the extension brackets have a red stripe on the Pin-1 side of the cable.

Extended USB Module

This module bracket has two USB ports for more USB devices (USB port 3-4).

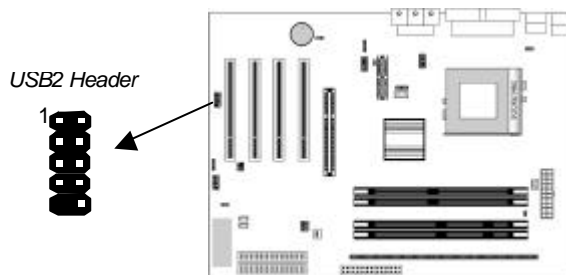

1. Locate the USB2 header on the mainboard.
2. Plug the bracket cable onto the USB2 header.
3. In the system chassis, remove a slot cover from one of the expansion slots and install the extension bracket in the opening. Use the screw that held the slot cover in place to secure the extension bracket to the chassis.

Install Other Devices

Install and connect any other devices in the system following the steps below.

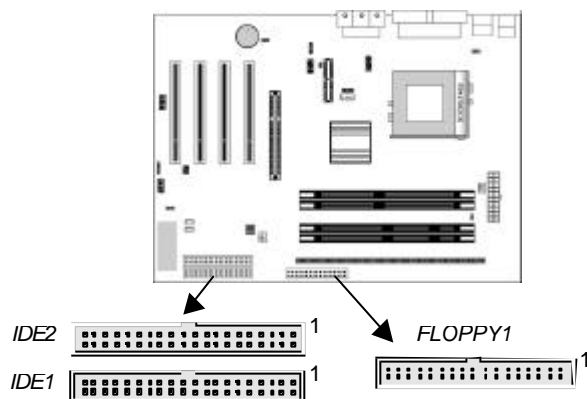

Floppy Disk Drive

The mainboard ships with a floppy disk drive cable that can support one or two drives. Drives can be 3.5" or 5.25" wide, with capacities of 360K, 720K, 1.2MB, 1.44MB, or 2.88MB.

Install your drives and connect power from the system power supply. Use the cable provided to connect the drives to the floppy disk drive connector **FLOPPY1**.

IDE Devices

IDE devices include hard disk drives, high-density diskette drives, and CD-ROM or DVD-ROM drives, among others.

The mainboard ships with an IDE cable that can support one or two IDE devices. If you connect two devices to a single cable, you must configure one of the drives as Master and one of the drives as Slave. The documentation of the IDE device will tell you how to configure the device as a Master or Slave device. The Master device connects to the end of the cable.

Install the device(s) and connect power from the system power supply. Use the cable provided to connect the device(s) to the Primary IDE channel connector **IDE1** on the mainboard.

If you want to install more IDE devices, you can purchase a second IDE cable and connect one or two devices to the Secondary IDE

channel connector **IDE2** on the mainboard. If you have two devices on the cable, one must be Master and one must be Slave.

Internal Sound Connections

If you have installed a CD-ROM drive or DVD-ROM drive, you can connect the drive audio cable to the onboard sound system.

On the mainboard, locate the two 4-pin connectors **CD1** and **CD2**. There are two kinds of connector because different brands of CD-ROM drive have different kinds of audio cable connectors. Connect the cable to the appropriate connector.

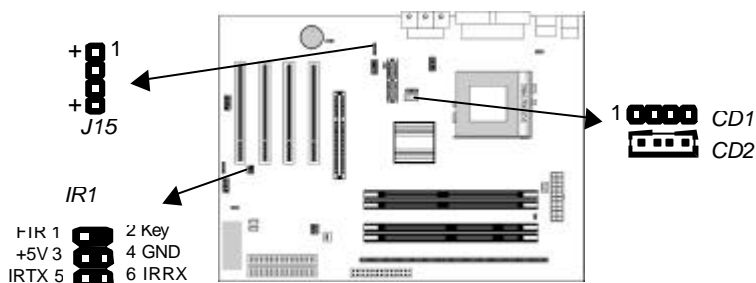

Infrared Port

You can connect an infrared port to the mainboard. You can purchase this option from third-party vendors.

1. Locate the infrared port **IR1** header on the mainboard.
2. If you are adding an infrared port, connect the ribbon cable from the port to the IR1 header and then secure the port to an appropriate place in your system chassis.

Onboard LAN LED Connections

If you have a set indicator LEDs for the onboard LAN communication, you can connect the LED cable to the header **J15**. Pins 1-2 are for Link LED. Pins 3-4 are for 10/100 Mbps mode LED, the onboard LAN run in 100 Mbps mode when the LED lit.

Expansion Slots

This mainboard has four 32-bit PCI slots, one AGP slot and one AMR slot.

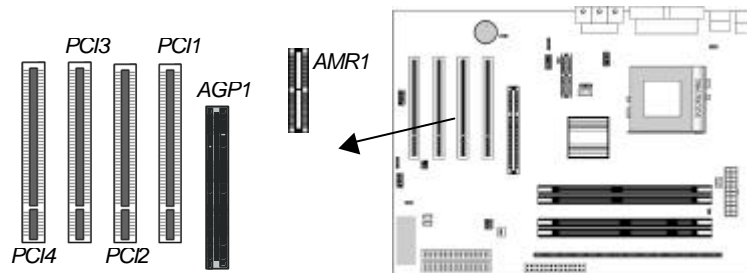

Follow the steps below to install a PCI/AGP/AMR expansion card.

1. Locate the AMR, AGP or PCI slots on the mainboard.
2. Remove the slot cover for this slot from the system chassis.
3. Insert the expansion card edge connector into the slot and press it firmly down into it so that it is fully inserted.
4. Secure the expansion card bracket to the system chassis using the screw that held the slot cover in place.

AMR Slot

The AMR (Audio Modem Riser) slot is an industry standard slot that allows for the installation of a special audio/modem riser card. Different territories have different regulations regarding the specifications of a modem card. You can purchase an AMR card that is approved in your area and install it directly into the AMR slot.

Wake On LAN (WOL)

If you have installed a LAN adapter expansion card, connect the card to the Wake On LAN connector **WOL1**. This allows incoming traffic to resume the system from a software power down. You need to enable this feature in the BIOS setup utility.

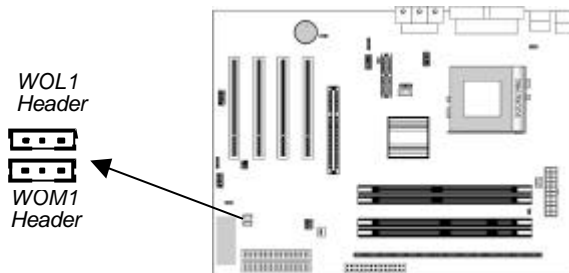

Wake On Modem

If you have installed a fax/modem card, connect the fax/modem to the Wake On Modem connector **WOM1**. You can then use the setup utility to program your computer to resume from a power saving mode whenever there is an incoming call to the fax/modem.

Chapter 3

BIOS Setup Utility

Introduction

The BIOS Setup Utility records settings and information about your computer such as the date and time, the kind of hardware installed, and various configuration settings. Your computer uses this information to initialize all the components when booting up and functions as the basis for coordination between system components.

If the Setup Utility configuration is incorrect, it may cause the system to malfunction. It can even stop your computer from booting properly. If this happens, you can use the clear CMOS jumper to clear the CMOS memory used to store the configuration information.

You can run the setup utility and manually make changes to the configuration. You might need to do this to configure some of the hardware that you install on or connect to the mainboard, such as the CPU, system memory, disk drives, etc.

Running the Setup Utility

Each time your computer starts, before the operating system loads, a message appears on the screen that prompts you to “Hit if you want to run SETUP”. When you see this message, press the **Delete** key and the Main menu page of the Setup Utility appears on your monitor.

AMIBIOS SIMPLE SETUP UTILITY – VERSION 1.21.01 ©2000 American Megatrends, Inc. All Rights Reserved	
Standard CMOS Setup	Features Setup
Advanced Setup	CPU PnP Setup
Power Management Setup	Hardware Monitor
PCI / Plug and Play Setup	Change Password
Load Optimal Settings	Exit
Load Best Performance Settings	
ESC: Quit ↑↓←→: Select Item (Shift)F2: Change Color F5: Old Values F6: Optimal values F7: Best performance values F10: Save&Exit	

You can use the cursor arrow keys to highlight any of the options on the main menu page. Press **Enter** to select the highlighted option. To leave the setup utility, press the **Escape** key. To cycle through the Setup Utility’s optional color schemes hold down the **Shift** key and press **F2**.

Some of the options on the main menu page lead to tables of items with installed values. In these pages, use the cursor arrow keys to highlight the items, and then use the **PgUp** and **PgDn** keys to cycle through the alternate values for each of the items. Other options on the main menu page lead to dialog boxes which require you to answer Yes or No by hitting the **Y** or **N** keys.

If you have already made changes to the setup utility, press **F10** to save those changes and exit the utility. Press **F5** to reset the changes to the original values. Press **F6** to install the setup utility with a set of default values. Press **F7** to install the setup utility with a set of high-performance values.

Standard CMOS Setup Page

Use this page to set basic information such as the date, the time, the IDE devices, and the diskette drives. If you press the F3 key, the system will automatically detect and configure the hard disks on the IDE channels.

AMIBIOS SETUP - STANDARD CMOS SETUP										
©2000 American Megatrends, Inc. All Rights Reserved										
Date (mm/dd/yy) : Tue Mar 27, 2001										
Time (hh/mm/ss) : 14:26:53										
	Type	Size	Cyln	Head	WPcom	Sec	LBA Mode	Bk Mode	PIO Mode	32Bit Mode
Pri Master	: Auto									On
Pri Slave	: Auto									On
Sec Master	: Auto									On
Sec Slave	: Auto									On
Floppy Drive A : 1.44MB 3 1/2"										
Floppy Drive B : Not Installed										
Month : Jan - Dec										
Day : 01 - 31										
Year : 1901 - 2099										
ESC : Exit										
- : Select Item										
P/UP/D/↓ : Modify										
(Shift)F2 : Color										
F3 : Detect All HDD										

Date & Time	Use these items to set the system date and time
Pri Master	Use these items to configure devices connected to the Primary and Secondary IDE channels. To configure an IDE hard disk drive, choose <i>Auto</i> . If the <i>Auto</i> setting fails to find a hard disk drive, set it to <i>User</i> , and then fill in the hard disk characteristics (Size, Cyls, etc.) manually. If you have a CD-ROM drive, select the setting <i>CDROM</i> . If you have an ATAPI device with removable media (e.g. a ZIP drive or an LS-120) select <i>Floptical</i> .
Pri Slave	
Sec Master	
Sec Slave	
Floppy Drive A Floppy Drive B	Use these items to set the size and capacity of the floppy diskette drive(s) installed in the system.

Advanced Setup Page

Use this page to set more advanced information about your system. Take some care with this page. Making changes can affect the operation of your computer.

AMIBIOS SETUP – ADVANCED SETUP (C) 2000 American Megatrends, Inc. All Rights Reserved		
Trend ChipAway Virus	Enabled	
Quick Boot	Enabled	
1 st Boot Device	IDE-0	
2 nd Boot Device	Floppy	
3 rd Boot Device	CDROM	
Try Other Boot Devices	Yes	
S.M.A.R.T. for Hard Disks	Disabled	
PS/2 Mouse Support	Enabled	
Boot To OS/2 > 64MB	No	
L1 Cache	Enabled	
L2 Cache	Enabled	
DRAM Time/Freq. by SPD	Enabled	
DDR/SDR CAS Select	2.5/3	
Dram Performance	Normal	
AGP Delay Offset	Auto	
AGP Driving Strength	Auto	
		ESC : Quit ↑↓←→ : Select Item
		F1 : Help PU/PD/+/- : Modify
		F5 : Old Values (Shift)F2 : Color
		F6 : Load Optimal values
		F7 : Load Best performance values

Trend ChipAway Virus	This mainboard has built-in virus protection in the firmware. Use this item to enable or disable the built-in virus protection.
Quick Boot	If you enable this item, the system starts up more quickly by elimination of some of the power on test routines.
1st Boot Device 2nd Boot Device 3rd Boot Device	Use these items to determine the device order the computer uses to look for an operating system to load at start-up time.
Try Other Boot Device	If you enable this item, the system will also search for other boot devices if it fails to find an operating system from the first two locations.
S.M.A.R.T. for Hard Disks	Enable this item if any IDE hard disks support the S.M.A.R.T. (Self-Monitoring, Analysis and Reporting Technology) feature.
PS/2 Mouse Support	If this item is set to Enabled, the onboard PS/2 Mouse port will work. Setting this to Disable turns off the port.
Boot to OS/2 > 64MB	Enable this item if you are booting the OS/2 operating system and you have more than 64MB of system memory installed.

L1/L2 Cache	Leave these items enabled since all the processors that can be installed on this board have internal cache memory.
DRAM Time/ Freq. by SPD	This item allows you to enable or disable the DRAM timing/Frequency defined by the Serial Presence Detect electrical.
DDR/SDR CAS Select	If the item DRAM Time/Freq. by SPD is disabled, you can use this item to determine the operation of the DDR/SDRAM memory CAS (column address strobe). We recommend that you leave this item at the default value.
Dram Performance	If the item DRAM Time/Freq. by SPD is disabled, you can use this item to select the performance of the installed SDRAM. We recommend that you leave this item at the default value.
AGP Delay Offset	This item can be used to offset driving current on the delay of AGP cards. Some AGP cards need delaying than normal driving current in order to operate. We recommend that you set this item to Auto by default.
AGP Driving Strength	This item can be used to signal driving current on AGP cards to auto or Manual. Some AGP cards need stronger than normal driving current in order to operate. We recommend that you set this item to Auto by default.

Power Management Setup Page

This page sets some of the parameters for system power management operation.

AMIBIOS SETUP – POWER MANAGEMENT SETUP (C) 2000 American Megatrends, Inc. All Rights Reserved		
Power Management	Disabled	
Ring On Power On	Disabled	
Resume On PME#	Disabled	
RTC Alarm Power On	Disabled	
RTC Alarm Date	Every Day	
RTC Alarm Hour	12	
RTC Alarm Minute	30	
RTC Alarm Second	30	
KeyBoard PowerOn	Disabled	
HotKey Select	N/A	
		ESC : Quit ↑↓←→ : Select Item F1 : Help PU/PD/+/- : Modify F5 : Old Values (Shift)F2 : Color F6 : Load Optimal values F7 : Load Best performance values

Power Management	Use this item to select a power management scheme. Both APM and ACPI are supported.
Ring On Power On	The system can be turned off with a software command. If you enable this item, the system can automatically resume if there is an incoming call on the Fax/Modem. You must use an ATX power supply in order to use this feature.
Resume On PME#	The system can be turned off with a software command. If you enable this item, the system can automatically resume if there is traffic on the onboard network adapter or PCI LAN/Modem card. You must use an ATX power supply in order to use this feature.
RTC Alarm Power On / Date / Hour / Minute / Second	The system can be turned off with a software command. If you enable this item, the system can automatically resume at a fixed time based on the system's RTC (realtime clock). Use the items below this one to set the date and time of the wake-up alarm. You must use an ATX power supply in order to use this feature.
KeyBoard Power On	If you enable this item, you can turn the system on and off by pressing hot keys on the keyboard. You must enable the Keyboard Power On jumper and use an ATX power supply in order to use this feature.

HotKey Select	If the item KeyBoard PowerOn is enabled, you can use this item to select the hot keys to power on the system.
----------------------	---

PCI / Plug and Play Setup Page

This page sets some of the parameters for devices installed on the PCI bus and devices that use the system plug and play capability.

AMIBIOS SETUP – PCI / PLUG AND PLAY SETUP (C) 2000 American Megatrends, Inc. All Rights Reserved	
Plug and Play Aware O/S	Yes
Primary Graphics Adapter	PCI
PCI VGA Palette Snoop	Disabled
Allocate IRQ for PCI VGA	Yes
ESC : Quit ↑↓←→ : Select Item F1 : Help PU/PD/+/- : Modify F5 : Old Values (Shift)F2 : Color F6 : Load Optimal values F7 : Load Best performance values	

Plug and Play Aware O/S	Enable this item if you are using an O/S that supports Plug and Play such as Windows 95 or 98.
Primary Graphics Adapter	This item indicates if the primary graphics adapter uses the PCI or the AGP bus. The default PCI setting still lets the onboard display work and allows the use of a second display card installed in a PCI slot.
PCI VGA Palette Snoop	When this item is enabled, multiple VGA devices operating on different buses can handle data from the CPU on each set of palette registers on every video device.
Allocate IRQ for PCI VGA	If this item is enabled, an IRQ will be assigned to the PCI VGA graphics system. You set this value to No to free up an IRQ.

Load Optimal Settings

If you select this item and press **Enter** a dialog box appears. If you press **Y**, and then **Enter**, the Setup Utility loads a set of fail-safe default values. These default values are not very demanding and they should allow your system to function with most kinds of hardware and memory chips.

Load Best Performance Settings

If you select this item and press **Enter** a dialog box appears. If you press **Y**, and then **Enter**, the Setup Utility loads a set of best-performance default values. These default values are quite demanding and your system might not function properly if you are using slower memory chips or other low-performance components.

Features Setup Page

This page sets some of the parameters for peripheral devices connected to the system.

AMBIOS SETUP – PERIPHERAL SETUP (C) 2000 American Megatrends, Inc. All Rights Reserved		
OnBoard FDC	Enabled	
OnBoard Serial Port1	3F8h/COM1	
OnBoard Serial Port2	2F8h/COM2	
OnBoard Ir Port	Disabled	
Ir Port Mode	N/A	
Ir Port IRQ	N/A	
Ir Port DMA	N/A	
Ir Transceiver Type	N/A	
Ir Half-Duplex TimeOut	N/A	
OnBoard Parallel Port	378h	
Parallel Port Mode	Normal	
EPP Version	N/A	
Parallel Port IRQ	7	
Parallel Port DMA	N/A	
OnBoard IDE	Both	
Ultra DMA Support	Disabled	ESC : Quit ↑↓←→ : Select Item
OnBoard AC' 97 Audio	Enabled	F1 : Help PU/PD/+/- : Modify
OnBoard AC' 97 Modem	Auto	F5 : Old Values (Shift)F2 : Color
OnBoard USB Function	Enabled	F6 : Load Optimal values
USB Function for DOS	Disabled	F7 : Load Best performance values

OnBoard FDC	Use this item to enable or disable the onboard floppy disk drive interface.
--------------------	---

OnBoard Serial Port1/2	Use these items to enable or disable the onboard COM1/2 serial port, and to assign a port address.
OnBoard Ir Port, IR items	Use this item to enable or disable the Infrared port, and to assign a port address. If you select a specific address, the resources are assigned to the IR port, and you can use the five items below to determine the operation of the IR port
Onboard Parallel Port	Use this item to enable or disable the onboard LPT1 parallel port, and to assign a port address. The Auto setting will detect and available address.
Parallel Port Mode	Use this item to set the parallel port mode. You can select SPP (Standard Parallel Port), ECP (Extended Capabilities Port), EPP (Enhanced Parallel Port), or ECP + EPP.
EPP Version	Use this item to determine the EPP version, if you have set the Parallel Port Mode to EPP
Parallel Port IRQ	Use this item to assign either IRQ 5 or 7 to the parallel port.
Parallel Port DMA	Use this item to assign a DMA channel to the parallel port. The options are 0, 1 and 3.
Onboard IDE	Use this item to enable or disable either or both of the onboard Primary and Secondary IDE channels.
Ultra DMA Support	Use this item to set Ultra DMA for IDE devices on the IDE channels. You must enable this or UDMA devices will not work at their intended speed.
Onboard AC' 97 Audio	This item enables or disables the onboard AC' 97 audio chip.
Onboard AC' 97 Modem	This item enables or disables the onboard AC' 97 modem chip.
Onboard USB Function	Enable this item if you plan to use the USB ports on this mainboard.
USB Function for DOS	Enable this item if you plan to use the USB ports on this mainboard in a DOS environment.

CPU PnP Setup Page

This page lets you manually configure the mainboard for the CPU. The system will automatically detect the kind of CPU that you have installed and make the appropriate adjustments to the items on this page.

AMBIOS SETUP - CPU PnP SETUP	
©2000 American Megatrends, Inc. All Rights Reserved	
CPU BRAND	AMD K7
CPU Type	Athlon
CPU Speed	933 MHz
CPU Ratio	7.0x
ESC : Quit ↑↓←→ : Select Item F1 : Help PU/PD+/- : Modify F5 : Old Values (Shift) F2 : Color F6 : Load Optimal values F7 : Load Best performance values	

CPU BRAND/Type/ Ratio	These items show the kind, core voltage, ratio and frequency of CPU that has installed in your system.
CPU Speed	Use this item to set the CPU speed that has installed in your system.

Hardware Monitor Page

This page sets some of the parameters for the hardware monitoring function of this mainboard.

AMIBIOS SETUP – HARDWARE MONITOR (C) 2000 American Megatrends, Inc. All Rights Reserved	
--- Hardware Monitor ---	
System Temperature	
CPU Temperature	30°C/86°F
System Fan	
CPU Fan	
5V	5.000 V
3.3Vin	3.300 V
12Vin	12.000 V
Vcore	
ESC : Quit ↑↓←→ : Select Item F1 : Help PU/PD/+/- : Modify F5 : Old Values (Shift) F2 : Color F6 : Load Optimal values F7 : Load Best performance values	

System / CPU Temperature	These items display CPU and system temperature measurement.
FANS & Voltage Measurements	These items indicate cooling fan speeds in RPM and the various system voltage measurements.

Change Password

If you highlight this item and press **Enter**, a dialog box appears which lets you enter a Supervisor password. You can enter no more than six letters or numbers. Press **Enter** after you have typed in the password. A second dialog box asks you to retype the password for confirmation. Press **Enter** after you have retyped it correctly. The password is then required to access the Setup Utility or for that and at start-up, depending on the setting of the Password Check item in Advanced Setup.

Change or Remove the Password

Highlight this item, press **Enter** and type in the current password. At the next dialog box, type in the new password, or just press **Enter** to disable password protection.

Exit

Highlight this item and press **Enter** to save the changes that you have made in the Setup Utility configuration and exit the program. When the Save and Exit dialog box appears, press **Y** to save and exit, or press **N** to exit without saving.

Chapter 4

Using the Mainboard Software

About the Software CD-ROM

The support software CD-ROM that is included in the mainboard package contains all the drivers and utility programs needed to properly run the bundled products. Below you can find a brief description of each software program, and the location for your mainboard version. More information on some programs is available in a README file, located in the same directory as the software.

***Note:** Never try to install software from a folder that is not specified for use with your mainboard.*

Before installing any software, always inspect the folder for files named README.TXT, INSTALL.TXT, or something similar. These files may contain important information that is not included in this manual.

Auto-installing under Windows 98

The Auto-install CD-ROM makes it easy for you to install the drivers and software for your mainboard.

***Note:** If the Auto-install CD-ROM does not work on your system, you can still install drivers through the file manager for your OS (for example, Windows Explorer). Refer to Utility Software Reference later in this chapter.*

The support software CD-ROM disc loads automatically under Windows 98. When you insert the CD-ROM disc in the CD-ROM drive, the autorun feature will automatically bring up the install screen. The screen has three buttons on it, **Setup**, **Browse CD** and **Exit**.

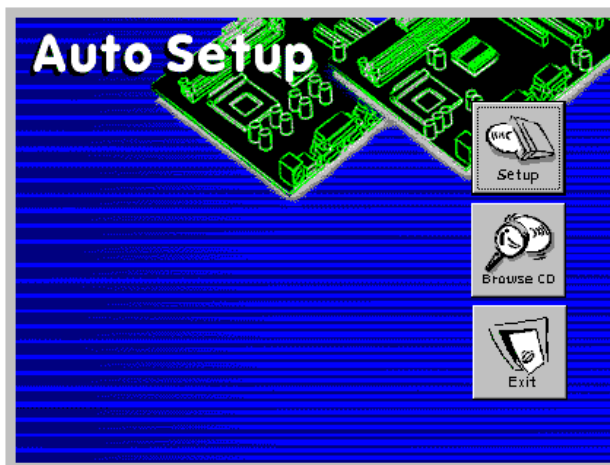

***Note:** If the opening screen doesn't appear, double-click the file "setup.exe" in the root directory.*

1. Setup

Click the **Setup** button to run the software installation program. Select from the menu which software you want to install.

2. Browse CD

The **Browse CD** button is the standard Windows command that allows you to open Windows Explorer and show the contents of the support CD.

Before installing the software from Windows Explorer, look for a file named README.TXT, INSTALL.TXT or something similar. This file may contain important information to help you install the software correctly.

Some software is installed in separate folders for different operating systems, such as DOS, WIN NT, or WIN98/95. Always go to the correct folder for the kind of OS you are using.

To install the software, execute a file named SETUP.EXE or INSTALL.EXE by double-clicking the file and then following the instructions on the screen.

3. Exit

The **Exit** button closes the Auto Setup window.

Note: The following screens are examples only. The screens and driver lists will be different according to the mainboard you are installing.



The mainboard identification is located in the upper left-hand corner. Click the **Next** button to run Auto Setup program.

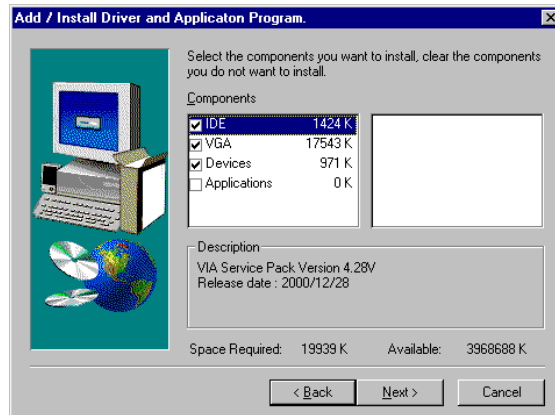

Check the box next to the items you want to install. The default options are recommended. Click the **Next** button to run the Installation Wizard. An item installation screen appears:

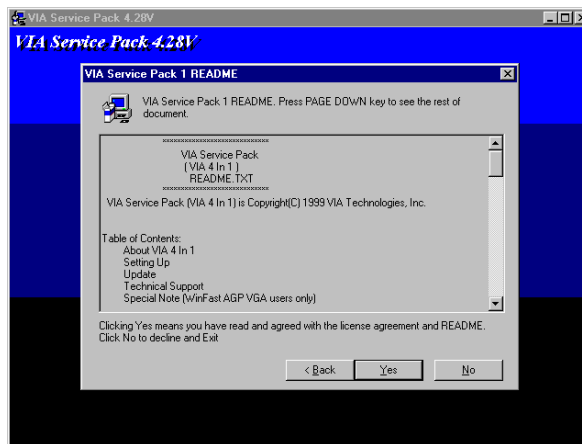

Follow the instructions on the screen to install the items. Drivers and software are automatically installed in sequence. Follow the onscreen instructions, confirm commands and allow the computer to restart after each installation.

Manual Installation

Insert the CD in the CD-ROM drive and locate the PATH.DOC file in the root directory. This file contains the information needed to locate the drivers for your mainboard.

Look for the chipset and mainboard model; then browse to the directory and path to begin installing the drivers. Most drivers have a setup program (SETUP.EXE) that automatically detects your operating system before installation. Other drivers have the setup program located in the operating system subfolder.

If the driver you want to install does not have a setup program, browse to the operating system subfolder and locate the readme text file (README.TXT or README.DOC) for information on installing the driver or software for your operating system.

Utility Software Reference

All the utility software available on the CD-ROM is Windows compliant. It is provided only for the convenience of customers. The following software is furnished under license and may only be used or copied in accordance with the terms of the license.

Note: The software in these folders is subject to change at anytime without prior notice. Please refer to the support CD for available software.

AMI Flash Memory Utility

This utility enables you to erase the system BIOS stored on a Flash Memory chip on the mainboard, and lets you copy an updated version of the BIOS to the chip. Proceed with caution when using this program. If you erase the current BIOS and fail to write a new BIOS, or write a new BIOS that is incorrect, your system will malfunction. Refer to Chapter 3, Using BIOS for more information.

PC-cillin Software

The PC-CILLIN software program provides anti-virus protection for your system. This program is available for Windows 2000/ME/98SE and Windows NT. Be sure to check the readme.txt and install the appropriate anti-virus software for your operating system.

We strongly recommend users to install this free anti-virus software to help protect your system against viruses.

Note: Update your virus software regularly to protect

MediaRing Talk – Telephony Software

To install the MediaRing Talk voice modem software for the built-in modem, run MRTALK-SETUP72.EXE from the following directory:

\UTILITY\MEDIARING TALK

Super Voice – Fax/Modem Software

To install the Super Voice voice, fax, data communication application for use with the built-in fax/modem, run PICSHELL.EXE from the following directory:

\UTILITY\SUPER VOICE

CD Ghost

The CD Ghost software enables you to create a virtual cabinet of CD-ROM drives on your system to help you categorize and organize your CD collection. A user-friendly interface assists you in quickly creating images of both CDs and DVDs onto your system. To install the software, run SETUP.EXE from the following directory:

\UTILITY\CDGHOST\ENG\CDGHOST

Recovery Genius

The Recovery Genius software program is an innovative windows application system that protects your Hard Disk Drive from virus intrusion, accidental deletions, and system corruption. To install the Recovery Genius software program run SETUP.EXE from the following directory:

`\UTILITY\RECOVERY GENIUS\ENG\RECOVERYGENIUS`

Language Genius

The Language Genius is a software-based product that helps you to learn new languages. To install the Language Genius software program run SETUP.EXE from the following directory:

`\UTILITY\LANGUAGE GENIUS\ENG\LANGUAGEGENIUS`

PageABC

The PageABC application software enables you to create your own home page. To install the PageABC, run SETUP.EXE from the following directory:

`\UTILITY\PageABC`