

The PCjr

Admiring One of IBM's Biggest Mistakes

Introduction

- ▶ Who is this guy?
 - ▶ MobyGames, various software preservation projects, 8086 assembler hacker
- ▶ What I'll be covering
 - ▶ How the PCjr was born
 - ▶ PCjr's strengths and weaknesses
 - ▶ How and why it flopped so badly
 - ▶ How it changed the industry anyway
 - ▶ PCjr hacks and homebrews

A Burgeoning Market

- ▶ 1970s: Mass-production of the microprocessor enables affordable “home computers”
 - ▶ A class of microcomputers marketed to the nontechnical home consumer
 - ▶ Purpose: Games, education, home finances, word processing
- ▶ Initial success of Apple II, TRS-80, Commodore PET led to more than ten product lines in this space in two years
- ▶ By 1982, over 600K home computers sold at average price of \$530 (Byte, January 1983)

Popular Home Computers 1977 through 1981

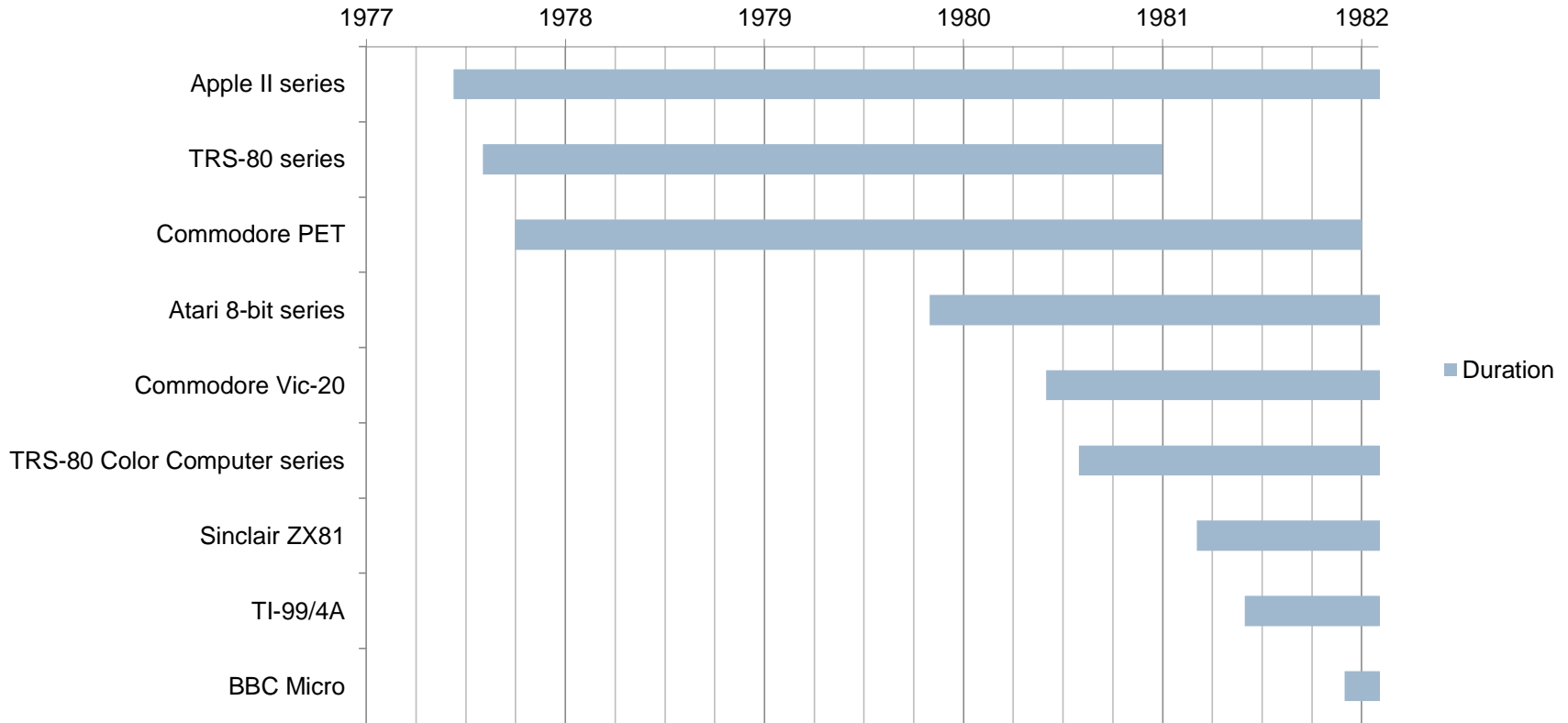

“Peanut”

- ▶ **February 1982**

- ▶ Task force formed to develop a home computer

- ▶ **January 1983**

- ▶ Rumors leaked that IBM was developing three new computers: Peanut, Rover, and Popcorn
 - ▶ “Peanut” eventually became the PCjr
 - ▶ “Rover” became the IBM 3270 PC
 - ▶ “Popcorn” became the IBM AT



Target Market

- ▶ IBM wanted to erode the large home computer market primarily dominated by the Apple II
- ▶ Initial Peanut design was for that market:
 - ▶ Small, friendly, easy to use, unintimidating

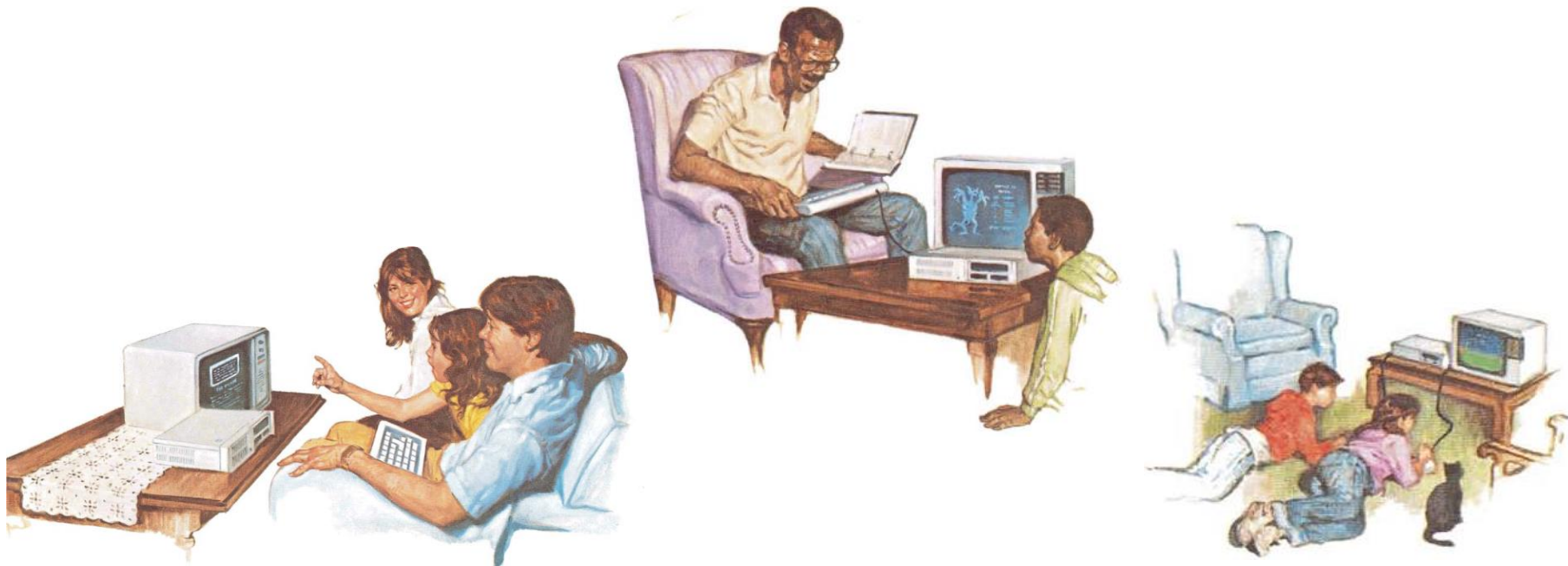

Target Market

- ▶ During design phase, marketing department wanted Peanut to grab more market share through secondary sales to businessmen and education
- ▶ Peanut would now be for the “Home, classroom, and office markets”

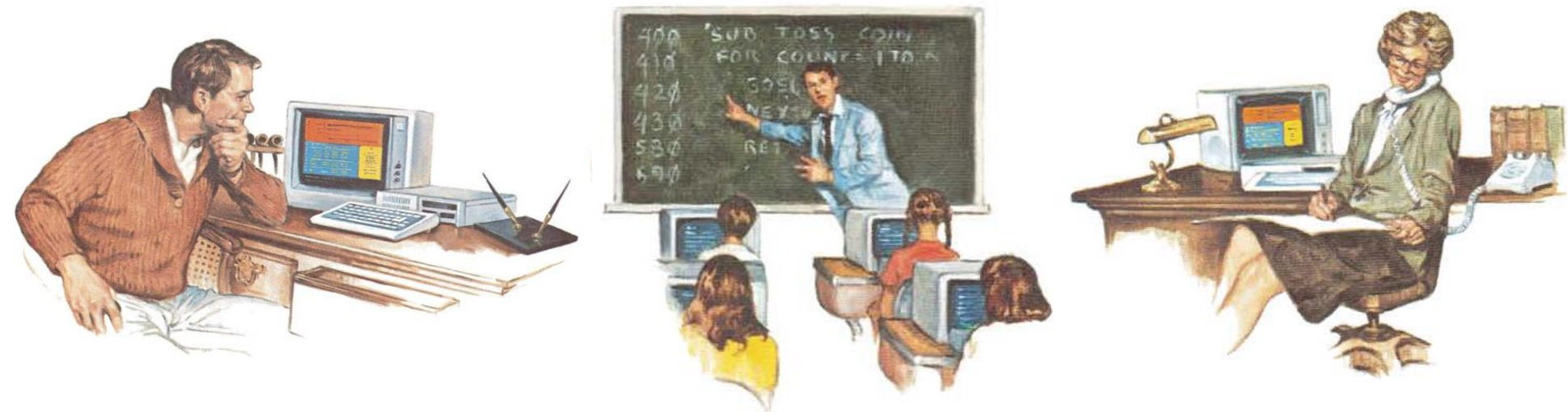

Anticipation

- ▶ **IBM's brand and reputation**
 - ▶ “...once it enters a market, IBM is likely to stay” – Anne Fisher
 - ▶ “Their biggest asset is those three letters” – Gartner Group
 - ▶ 1.3 million IBM PCs sold between 1981 and 1983 (Jeremy Reimer)
 - ▶ “(Analysts predict) hundreds of thousands, perhaps more than a million...would be sold next year” – New York Times, 11/02/1983
- ▶ **Prediction of success so high, Apple's stock price affected**
 - ▶ “...Apple announced that earnings for its fourth fiscal quarter, ending September 30, would be a fraction of what they had been a year earlier...The Peanut damage is done” – John Gantz, InfoWorld, 11/14/1983

Announced

- ▶ IBM Model 4860 “PCjr” Announced November 1st 1983
 - ▶ ... but with no ship date
- ▶ PCjr shown at live press conference a week later; industry reaction mixed
 - ▶ “With the Peanut, IBM is heralding a new era in the USA’s home computer industry” – John Hillkirk
 - ▶ “I guess it’s kind of what everyone expected...I don’t think there were any surprises.” – John Sculley, then Apple president



Why announce early but not ship?

- ▶ Conspiracy theory: IBM acted intentionally to hurt potential competitor's sales
- ▶ More likely theory: Technical issues
 - ▶ Repeatedly failed FCC certification due to too much RFI
 - ▶ IBM invented (and patented) a process that “sprayed liquid metal” to the inside of the case to pass certification.
 - ▶ Early formulas used silver – your PCjr might literally have a silver lining!
 - ▶ IBM needed time to get manufacturing cost down: PCjr cost \$450 in parts to make

Shipping (finally)

- ▶ First units start shipping January 13th 1984
- ▶ Shipments very low in number until March
 - ▶ Retail locations got shipments as display units before consumers

“Guaranteed Success”

- ▶ Over 100 PCjr-specific books published in anticipation of PCjr’s eventual success
 - ▶ The Time/Life Step-By-Step Guide to the IBM PCjr
 - ▶ PCjr Assembly Programming: A Gentle Introduction
 - ▶ Hey Junior! Using IBM’s Most Personal Computer
 - ▶ Peter Norton’s Discovering the IBM PCjr Home Computer
- ▶ ...and over 15 books dedicated to teaching kids how to program in BASIC on the PCjr

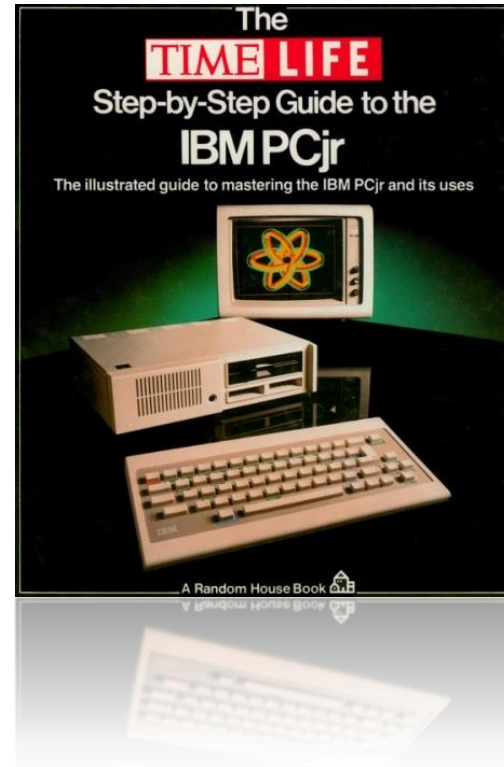

“Guaranteed Success”

- ▶ Four magazines dedicated to the PCjr:
 - ▶ jr (CW Communications)
 - ▶ Peanut (Harcourt Brace Jovanovich)
 - ▶ Compute for the PC and PCjr (ABC)
 - ▶ PCjr (Ziff-Davis)
 - ▶ Shipped before the PCjr did
- ▶ Why so many?
 - ▶ “(They) were started with the idea that the PCjr would sell well in schools and homes, opening up a whole new era of PC applications worthy of a magazine”
 - David Needle, InfoWorld, 10/8/1984

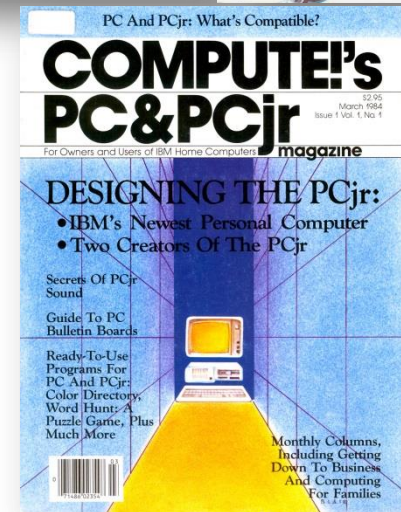
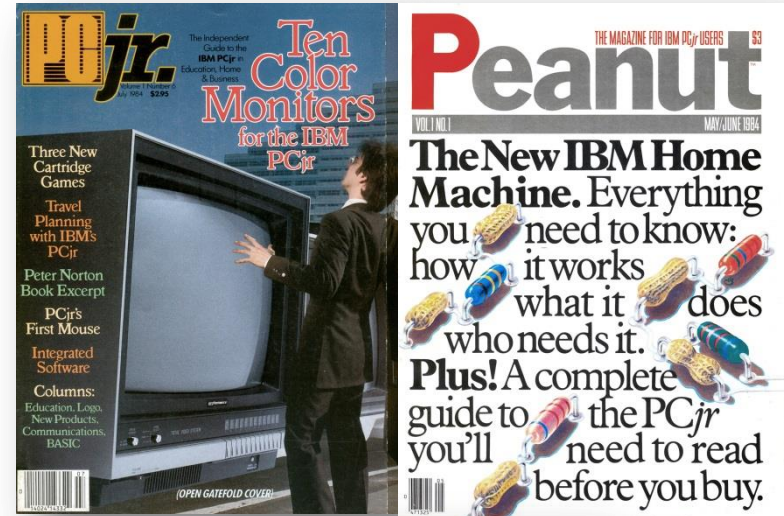



PCjr Advantages

PCjr Advantages

- ▶ **Compatibility**

- ▶ CPU, BIOS calls, OS same as IBM PC
- ▶ If it fit into PCjr's memory, it (usually) ran

- ▶ **Keyboard**

- ▶ Wireless! IBM called it the "Freeboard"
- ▶ Larger spaces around keys allowed for keyboard overlays to assist inexperienced users

PCjr Advantages: The Freeboard



PCjr Advantages: Keyboard Overlays

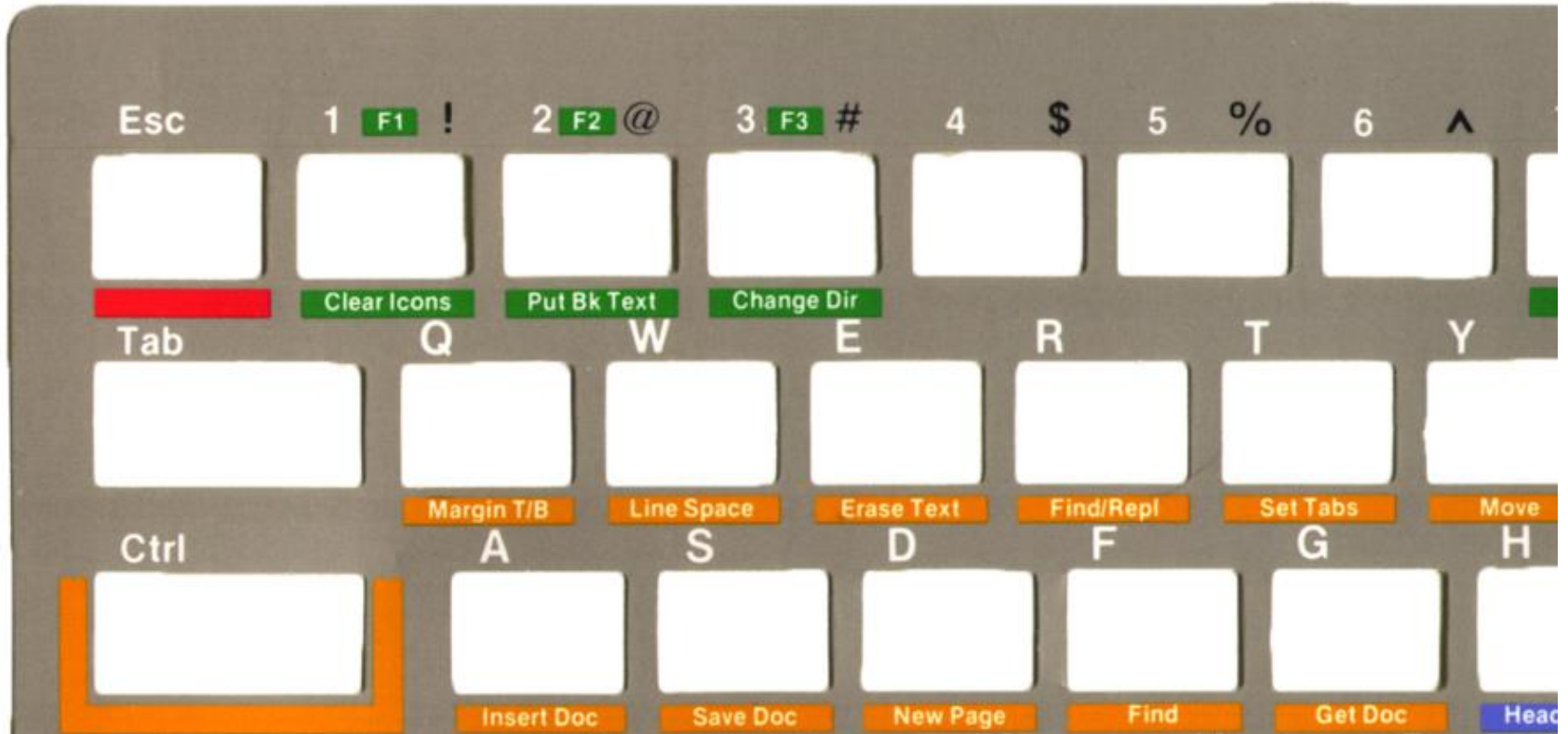

Close-up of Sierra HomeWord (word processor) keyboard overlay

Image credit: Michael Brutman

PCjr Advantages

- ▶ Small size and TV output intended for living room or den:



- ▶ Cartridges
 - ▶ Two cartridge slots, each for 64K ROM
 - ▶ Carts reboot the system, making loading programs effortless for beginner

PCjr Advantages: Cartridge Software

▶ Educational software:

- ▶ Facemaker
- ▶ Kindercomp
- ▶ Fraction Fever
- ▶ Colorpaint

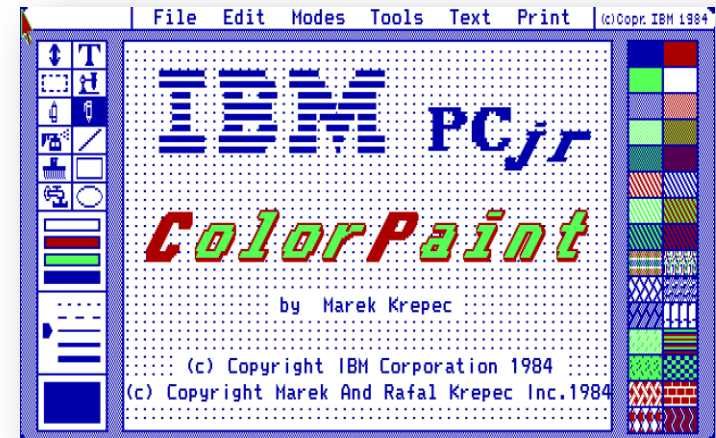
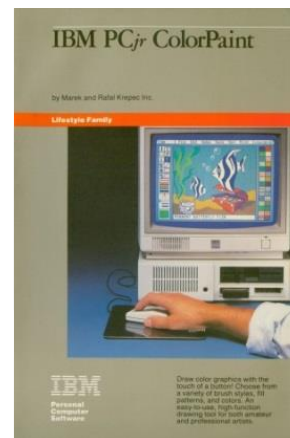
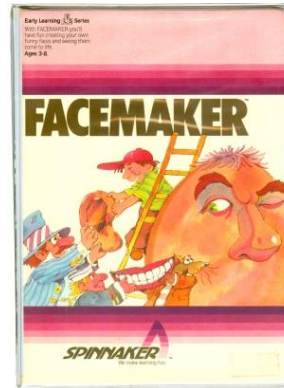

PCjr Advantages: Cartridge Software

▶ Business Software:

- ▶ Managing Your Money, Electric Desk, Cartridge BASIC
- ▶ Lotus 1-2-3 (Q3 1984):



E17: (,0) @SUM(E13..E16) READY

	A	B	C	D	E	F
	PROFIT AND LOSS PROJECTION - 1984					
		Q1	Q2	Q3	Q4	
1						
2						
3						
4						
5						
6						
7	Revenues					
8	Product Sales	325,421	331,929	338,568	345,339	
9	Rentals	81,335	82,982	84,642	86,335	
10	Maintenance Fees	48,813	49,789	58,785	51,881	
11		455,569	464,700	481,995	483,555	
12	Cost of Sales					
13	Material Costs	177,688	181,234	184,858	188,555	
14	Packaging Costs	7,107	7,249	7,394	7,542	
15	Shipping Costs	11,194	11,418	11,644	11,879	
16	Sales Commissions	16,271	16,596	233,361	23,828	
17		212,260	216,497	437,257	231,804	
18						
19						
20						

16-Mar-1984 10:24 PM JINDO

PCjr Advantages: Cartridge Software

- ▶ Games: River Raid, Crossfire, Demon Attack, Pitfall II, Mineshaft, Scuba Venture, Micro Surgeon, Mouser

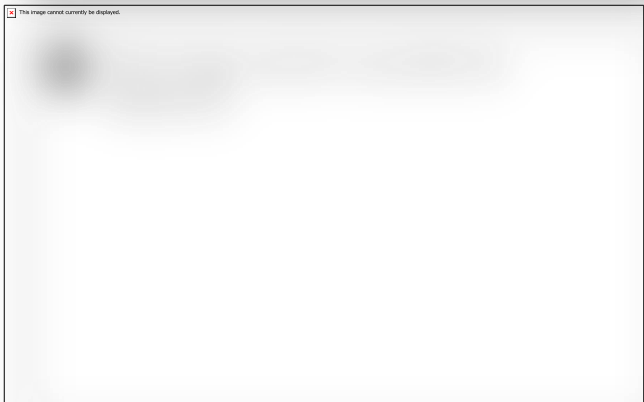

PCjr Advantages: Graphics

- ▶ Added three new graphics modes over CGA
 - ▶ 160x200x16
 - ▶ 320x200x16
 - ▶ 640x200x4
- ▶ 16 colors same as text colors
 - ▶ Graphics comparable to other home computers of the time
- ▶ Graphics used system RAM to support multiple video pages
- ▶ Nerdgasm: Hardware vertical retrace interrupt!

160x200x16

320x200x16

640x200x4

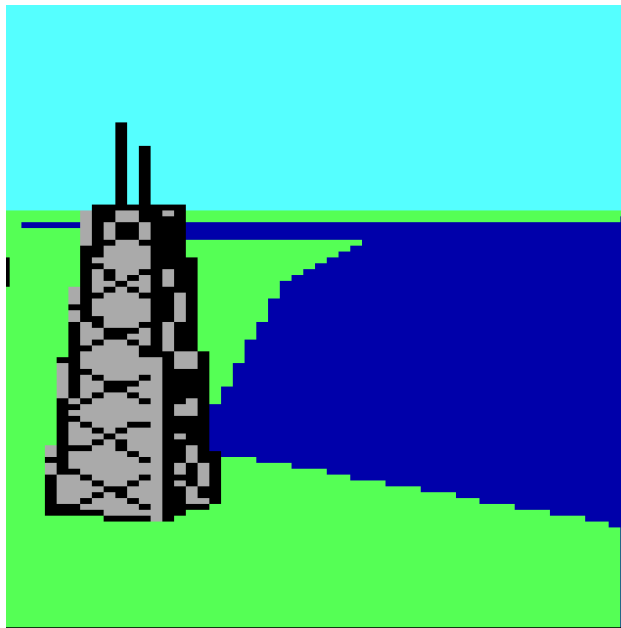

Print | (c) Copr. IBM 1984

A large graphic area with a dotted background. It features the word "Print" in large, blue, stylized letters. To the right is a vertical strip containing various patterns and colors, including solid colors, stripes, and checkerboards. Below the "Print" text, there is a copyright notice: "(c) Copr. IBM 1984".

F E T H	COMP	FUEL	
	330	E	E
	OMI	Q	LH
	000	OILT	OILP
	COM	GR	07
	124.85	LGT	07
NAV1	MG	B	
110.00	THE		
NAV2	XPDR		
111.35	1200		
TIME	RPM		
12:01:40	1605		

the King.
ed the light of

on 1984
pec Inc. 1984

PCjr Advantages: Sound

- ▶ 4-voice sound chip (3 tones + 1 noise)
- ▶ TI SN76496, same chip in:
 - ▶ Some coin-ops (Time Pilot, Mr. Do!)
 - ▶ Colecovision
 - ▶ BBC Micro
 - ▶ TI 99/4a
 - ▶ Sega Master System

DUAL-IN-LINE PACKAGE
(TOP VIEW)

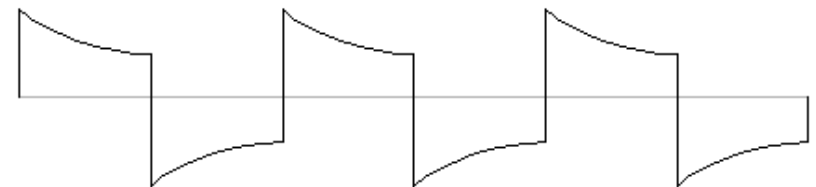
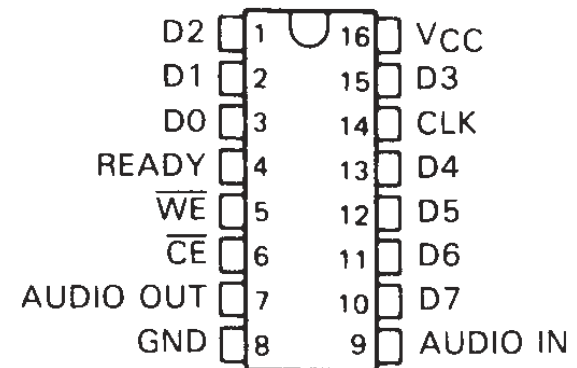

Sound Demonstration

Zeliard



PCjr Advantages: Expansion

- ▶ Most common ports built in
 - ▶ Two Joysticks
 - ▶ Serial printer
 - ▶ Analog video
 - ▶ Digital (RGB) video
 - ▶ Audio
 - ▶ Cassette
 - ▶ Modem (optional, 300 baud)
- ▶ Some uncommon ones too
 - ▶ Light pen
 - ▶ “L” port reserved for future use

PCjr Advantages: Sidecars

- ▶ “Sidecars” attached to the side of the case, didn’t require opening it up
- ▶ Common sidecars:
 - ▶ Standard parallel port
 - ▶ Additional memory (Q3 1984)
- ▶ Uncommon sidecars:
 - ▶ Power
 - ▶ Speech adapter
 - ▶ Cluster Adapter (network)

Image credit: oldcomputers.net



PCjr Advantages: Expanded ROM

▶ BASIC

- ▶ Like most home computers made before 1985, BASIC in ROM

▶ Advanced Diagnostics

- ▶ CTRL-ALT-INS to enter
- ▶ Pictures guide inexperienced users
- ▶ Extended tests of memory, disk drive, display, joysticks, sound chip, printer, modem, serial port, keyboard, and anything else it can recognize as attached

Main Menu



Video tests

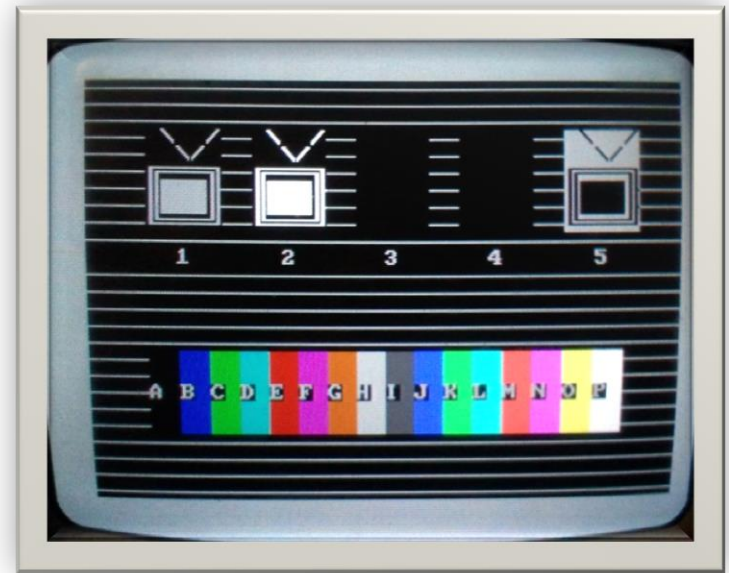

Sound test

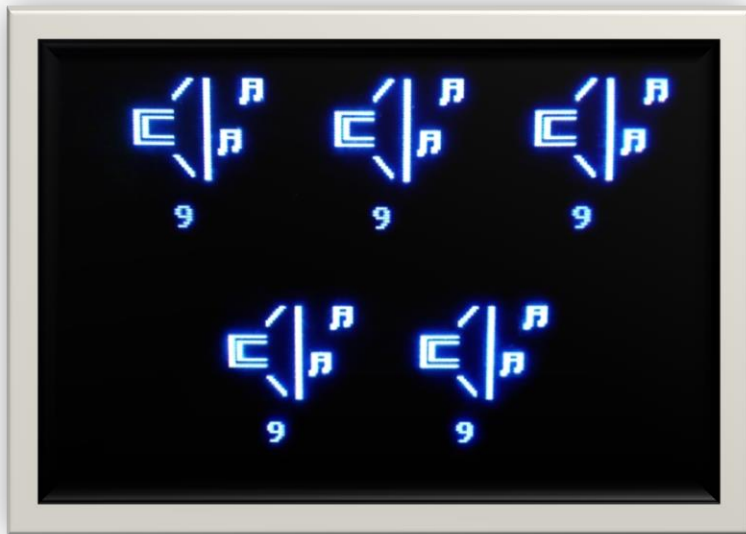

Disk drive test

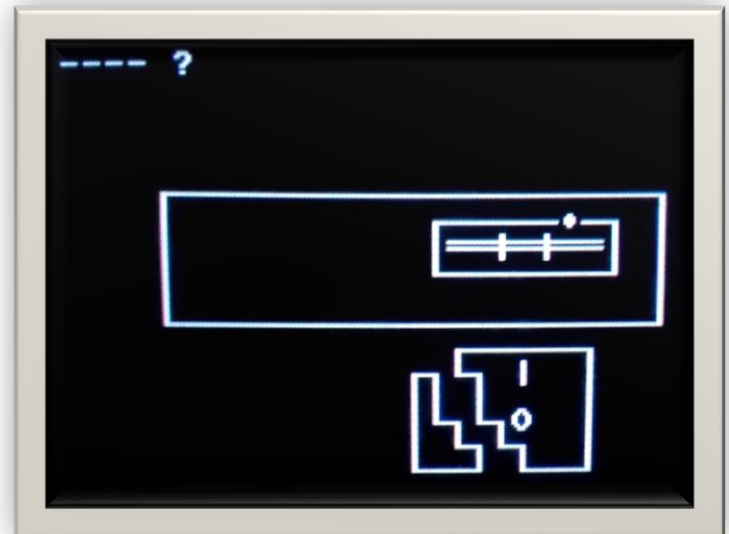

PCjr Disadvantages

PCjr Disadvantages: Cost

- ▶ Base model had 64K and no disk drive for \$699
- ▶ Expanded model had 128K and disk drive for \$1269
- ▶ Neither choice included a monitor, printer, software
- ▶ “With the exception of the Apple II, it was possible to purchase a complete system (computer, disk drive, and printer) from almost any of IBM's competitors for less money.”
 - Neil Adakonis, National Museum of American History

PCjr Disadvantages: Cost

- ▶ “Starter System” PCjr setup for the home was up to 4x the cost of its contemporaries

Description	*Price
128 KB System Unit W/Disk Drive Serial # _____	\$ 1269.00
Connector for TV	30.00
Keyboard Cord	20.00
IBM PCjr BASIC Cartridge	75.00
DOS 2.10	65.00
System Total Without Printer	\$ 1459.00 <input type="checkbox"/>
IBM PC Compact Printer Serial # _____	175.00
System Total With Printer	\$ 1634.00 <input type="checkbox"/>

Source: November 1983 IBM PCjr ordering sheet



PCjr Disadvantages: Cost

- ▶ “Fully loaded” PCjr setup was close to the price of a regular IBM PC but with less capability
 - ▶ \$6758 in 2013 dollars

Qty	Description	*Price
1	128 KB System Unit W/Disk Drive Serial # _____	\$ 1269.00
1	IBM Color Display Serial # _____	680.00
1	Adapter Cable for IBM Color Display	20.00
1	Keyboard Cord	20.00
1	IBM PCjr BASIC Cartridge	75.00
1	DOS 2.10	65.00
System Total without Printer		\$ 2129.00 □
1	IBM PC Compact Printer Serial # _____	175.00
System Total with Compact Printer		\$ 2304.00 □
1	IBM Graphics Printer Serial # _____	595.00
1	Parallel Printer Adapter	99.00
1	Printer Cable	55.00
1	Printer Stand	55.00
System Total with Graphics Printer		\$ 2933.00 □

Source: November 1983 IBM PCjr ordering sheet

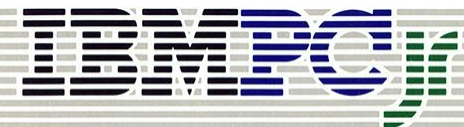

PCjr Disadvantages: RAM

- ▶ Limited to 128K; RAM expansions not available at launch
- ▶ Graphics stole RAM from main memory, making the problem worse
- ▶ Unlike IBM PC, memory wasn't parity protected
 - ▶ Memory errors went undetected

PCjr Disadvantages: Speed

- ▶ Entire 128K was essentially video memory – slow!
- ▶ System lacked DMA and keyboard microcontroller, forcing the CPU to handle both – slower!
- ▶ Effective speed was roughly half of the IBM PC – slowest PC ever made! *From IBM themselves!*

PCjr Disadvantages: Compatibility

- ▶ Despite compatible CPU, BIOS, and OS, some programs failed to run if they:
 - ▶ Controlled video hardware directly
 - ▶ Relied on strict timing loops (ie. copy protection)
 - ▶ Directly accessed the keyboard (ie. bypass the BIOS)
- ▶ The three most popular PC programs did not work on the PCjr at launch
 - ▶ Lotus 1-2-3
 - ▶ Microsoft Flight Simulator
 - ▶ Wordstar
 - ▶ PCjr-specific versions were released, but over half a year later

PCjr Disadvantages: Compatibility

MSFS on IBM PC (TV out)



MSFS on PCjr (TV out)

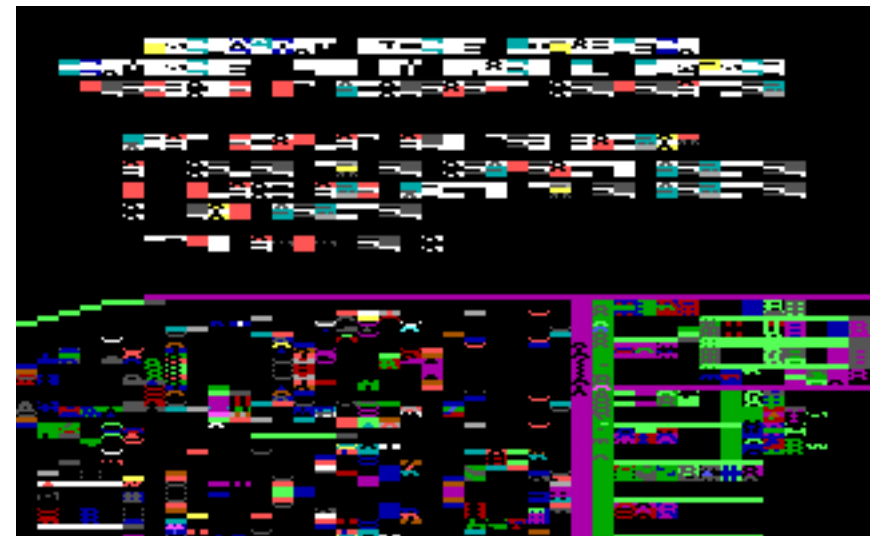

PCjr Disadvantages: Expandability

- ▶ Sidecar tech meant no ISA cards
- ▶ Too many sidecars took up too much space and needed extra power
 - ▶ In the form of a power sidecar!

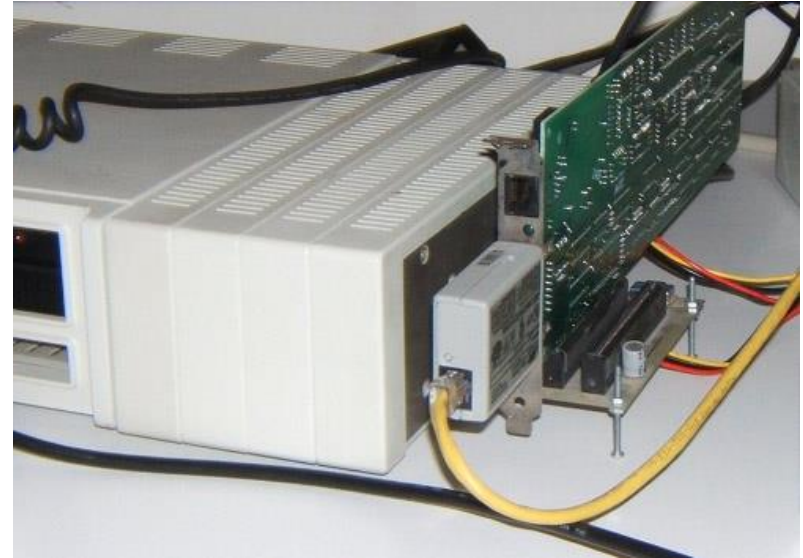

Frustrated hacker culture at IBM led to construction of ISA adapter and other hacks, never widely released

(image credit: Michael Brutman)

PCjr Disadvantages: Expandability

- ▶ Built-in ports used nonstandard connectors, requiring custom peripherals or adapter cables



Letter Designation	Connector Use
J	Left Joystick
J	Right Joystick
L	Spare
K	Keyboard
LP	Light Pen
T	Television

Letter Designation	Connector Use
V	Composite Video
D	Direct Drive Video
S	Serial Device
C	Cassette

PCjr Disadvantages: Expandability

- ▶ IBM never offered second floppy drive or hard drive
 - ▶ 3rd-parties provided
 - ▶ Some arrived after PCjr was already discontinued

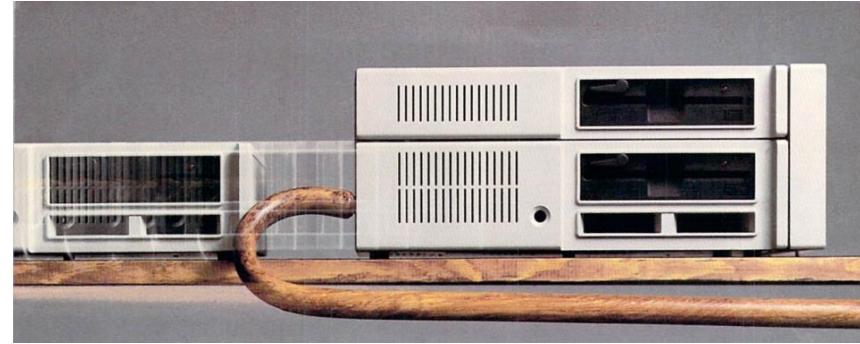

Racore "Drive Two", also included parallel port, clock, "PC mode" switch, memory expansion



Legacy Technologies' floppy and hard drive products

PCjr Disadvantages: Keyboard

- ▶ Used smaller keys
 - ▶ Mocked by the media as the “Chiclet” keyboard
 - ▶ Common complaint: Hard to touch-type on
- ▶ No numeric keypad or function keys
 - ▶ Had to hold down additional keys to emulate them
 - ▶ Some key combinations impossible (ie. **ALT** - \)
- ▶ No dedicated keyboard controller or buffer
 - ▶ If disk drive was busy when a key was hit, keystroke was lost
- ▶ Wireless ability was infrared
 - ▶ Required line-of-sight to the front of the computer



PCjr Disadvantages: Keyboard

- ▶ Described as “toy-like” and “mickey-mouse” by analysts
- ▶ “...it’s rubber-topped keys use a different kind of electrical contact that does not yield the full travel and crisp click of the PC’s keys”
 - Popular Science, Feb 1984
- ▶ “We suggest you buy the machine and then get another keyboard”
 - Salesman at an IBM Product Center on Madison Avenue



Reception

Blunder #1: Protecting Big Brother

- ▶ IBM intentionally limited the system so it wouldn't directly compete with the IBM PC
 - ▶ Yet tried to market it as being compatible anyway
- ▶ “...IBM's fear of undercutting its more profitable Personal Computer led it into design errors, including an awkward keyboard and limited memory.”
 - David Sanger, NYT, 5/17/1984



Blunder #2: Positioning and Price

- ▶ ~\$1600 was too expensive for the home market while also not powerful enough for serious users
 - ▶ \$1600 in 1983 dollars = \$3764 in 2013 dollars
- ▶ Target owners already happy with their segments
 - ▶ Most parents wanting a computer for teaching kids to program were satisfied with the \$200 street price Commodore 64
 - ▶ Serious business users could afford to pay more for the real thing (IBM PC)
- ▶ “(PCjr) may well be targeted to a gray area in the market that just does not exist.”
 - Peter Norton, NYT, 5/17/1984



Sound familiar?

- ▶ IBM's doomed strategy was the same as the Apple III
 - ▶ Each machine transformed outside its core competency
 - ▶ Apple III was an Apple II concept upsized to business market
 - ▶ PCjr was a PC downsized to home market
 - ▶ Both designed by committee
 - ▶ Both priced outside of what users were willing to pay
 - ▶ Both had a rushed design with several flaws
 - ▶ Apple III overheated
 - ▶ PCjr had RFI issues, compatibility issues
 - ▶ Both intentionally limited compatibility to protect more profitable product line



Image Credit: Wikipedia

Questionable Marketing Choices

- ▶ Charlie Chaplin's "The Tramp" was a child-like bumbling vagrant who walked uncomfortably due to ill-fitting secondhand clothes
- ▶ "Tramp" character worked favorably for IBM's expensive business machines as an ironic juxtaposition, but backfired for the PCjr
- ▶ Most home computers were advertised by familiar celebrities
 - ▶ Alan Alda for Atari, William Shatner for Commodore, Bill Cosby for TI 99/4a, Bill Bixby for Tandy, Dick Cavett for Apple, etc.



IBM PCjr

Questionable Marketing Choices

- ▶ IBM didn't sell PCjr like a home computer
- ▶ Rather than sell at K-Mart or Toys"R"Us, IBM chose to sell at IBM business centers
 - ▶ Intention was to position PCjr as "good enough for business"
- ▶ IBM business retail outlets did not get home consumer foot traffic, so most consumer exposure to the PCjr was from the press (who were not kind)



Questionable Marketing Choices

Typical home computer shopping



Photograph by Janet Beller for Family Computing Magazine VINI

IBM PCjr shopping



1983 Computerland press photo



Marketplace Performance

PCjr Struggles

- ▶ Sluggish sales and lackluster reviews
- ▶ Six months after PCjr started shipping, sales were down to 2,400 units a month
 - ▶ IBM PC selling up to 100x more in same period (David Bradley)
- ▶ “The machine has the smell of death about it.”
 - Steven Levy, Popular Computing
- ▶ PCjr-specific magazines start ceasing publication
 - ▶ Peanut lasted only two issues
 - ▶ Last to go was Ziff-Davis’ PCjr magazine in October 1984
 - ▶ “I will say that even with IBM’s name on it, I think the PCjr hasn’t got a chance without a magazine”
 - Wayne Green, former publisher of jr magazine

Insult to Injury: Apple IIc

- ▶ Apple announces the Apple IIc in April 1984, steals yet more market share
- ▶ Apple IIc outsells PCjr 6-to-1 through end of the year



IBM Responds

- ▶ July 31st 1984, IBM holds a press conference
 - ▶ RAM now officially expandable to 512K
 - ▶ Typewriter-style keyboard
 - ▶ Keyboard available for free to existing PCjr owners
 - ▶ Cost to IBM: \$5mil to replace 60,000 keyboards
 - ▶ Price cut: Expanded model reduced from \$1269 to \$999
 - ▶ Educational discounts for schools and teachers
- ▶ Same day, Lotus announces Lotus 1-2-3 for PCjr



1984 Q3, Q4 Mass Mailings

- ▶ **September, 2 million, Back-to-School Offer**
 - ▶ Buy a PCjr and monitor and get either a word processing or SAT preparation program for free
- ▶ **October, 8 million, Business offer**
 - ▶ Choice of three business software programs for free with a PCjr purchase
- ▶ **November, 10 million, Pre-Christmas push**
 - ▶ \$100 coupon on the purchase of a PCjr

Massive Christmas Push

- ▶ Big rebates for the 1984 Christmas season
 - ▶ \$999 got you an expanded PCjr with a color monitor
- ▶ Intense TV and print advertising
- ▶ Sold in Sears Business Centers, giving PCjr wider home consumer exposure
- ▶ Rebates plus advertising raised sales dramatically for the season
 - ▶ ...but advertising cost was hefty, nearly \$200 per unit sold



The Balloon Deflates

- ▶ Before Christmas: PCjr sales were 4% of all home computer purchases
- ▶ During Christmas push: Sales soared to 17%
- ▶ After Christmas: Back to 4%
- ▶ Out of ~300K total units sold over the life of the PCjr, ~200K were shipped during the xmas season

Death

- ▶ March 19th, 1985: IBM announces PCjr halting production
 - ▶ Only one year since it started shipping to consumers
- ▶ All print and media advertising stops
- ▶ “I'd say our PCjr program will be scaled back real fast”
 - Bill Gates, one week after announcement



Can't Give Them Away

- ▶ Estimated 100K to 350K units still left unsold
- ▶ May 1985
 - ▶ 27% price cut, plus forgiving financing
 - ▶ Retailers could take delivery but not pay until October
 - ▶ After October, dealers could return unsold inventory for full credit
- ▶ September 1985
 - ▶ Employee discount of expanded PCjr, monitor, and three software packages for \$450 (less than manufacturing cost)
 - ▶ Any school buying five IBM PCs received free PCjr
- ▶ At least \$45mil inventory written off (\$100mil in 2013 dollars)



Junior actually died a long time ago

- ▶ Analysts had predicted between 250K-500K sales by Q3 1984, but IBM only had to replace 60K keyboards
- ▶ Foreshadowing: “The week that IBM announced the PCjr its stock was the most heavily traded...closing at its lowest point (\$122.25) in weeks.”
 - InfoWorld V5, N48, P186
- ▶ “IBM hasn’t bought any 8088s for the PCjr from us since last July (of 1984)”
 - Gordon Moore, co-founder of Intel, at an early 1985 stockholders meeting





Aftermath

Third-party Industry

- ▶ 3rd-party industry created multifunction sidecars and expansions to help PCjr owners cope after it was discontinued
 - ▶ **Tecmar jrCaptain** added 512K, parallel port, and battery-backed clock in single sidecar
 - ▶ Other expansions: 2nd floppy drive, hard drive
 - ▶ At very end of PCjr's life, VGA and Sound Blaster-compatible sidecars were available from PC Enterprises

Turning Japanese

- ▶ IBM Japan observed PCjr effort, wanted to break into Japanese personal computer market
- ▶ Q4 1984, announces IBM JX, manufactured by Matsushita, for 270000 yen (\$2885 US)
- ▶ Not made at same PCjr facility, but based on PCjr tech
- ▶ Unlike PCjr, aimed at young business professionals



Image credit: poplars.world.cocan.jp

Turning Japanese

- ▶ **Enhancements:**
 - ▶ Higher-res graphics (750x512x2) for displaying Kanji
 - ▶ Dual 3.5" drives
 - ▶ Professional keyboard
 - ▶ 10MB hard drive option
- ▶ **Even bigger flop than PCjr**
 - ▶ 1984 sales were 6000 units
 - ▶ 1985 sales were 2000 units
- ▶ **Production halted Q2 1985**



Image credit: Wikipedia



Legacy

Sierra On-Line

- ▶ 1983: IBM contracts Sierra to create a family game for the PCjr
- ▶ Roberta designed the game geared towards new graphics and sound
- ▶ Result: King's Quest, which defined a new graphical adventure genre
- ▶ PCjr version flopped; later ports to the Tandy 1000, IBM PC, and Apple IIe were successful
- ▶ King's Quest sold more than half a million copies, started a decade of prosperity for Sierra

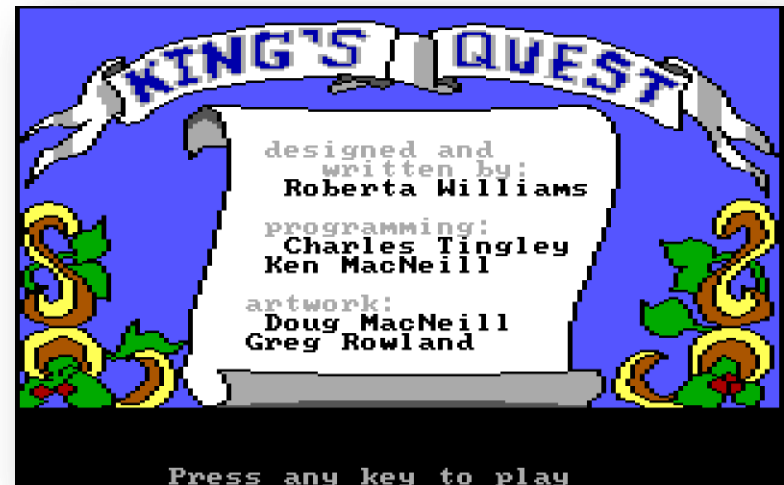

Tandy 1000

Image credit: trs-80.com

- ▶ Announced October 1984, on sale a month later
- ▶ Clone of PCjr, but with all of its strengths and none of its weaknesses
 - ▶ PCjr graphics and sound
 - ▶ Typewriter keyboard
 - ▶ Same speed as IBM PC
 - ▶ Accepted most ISA cards
 - ▶ Optional second floppy drive, hard drive

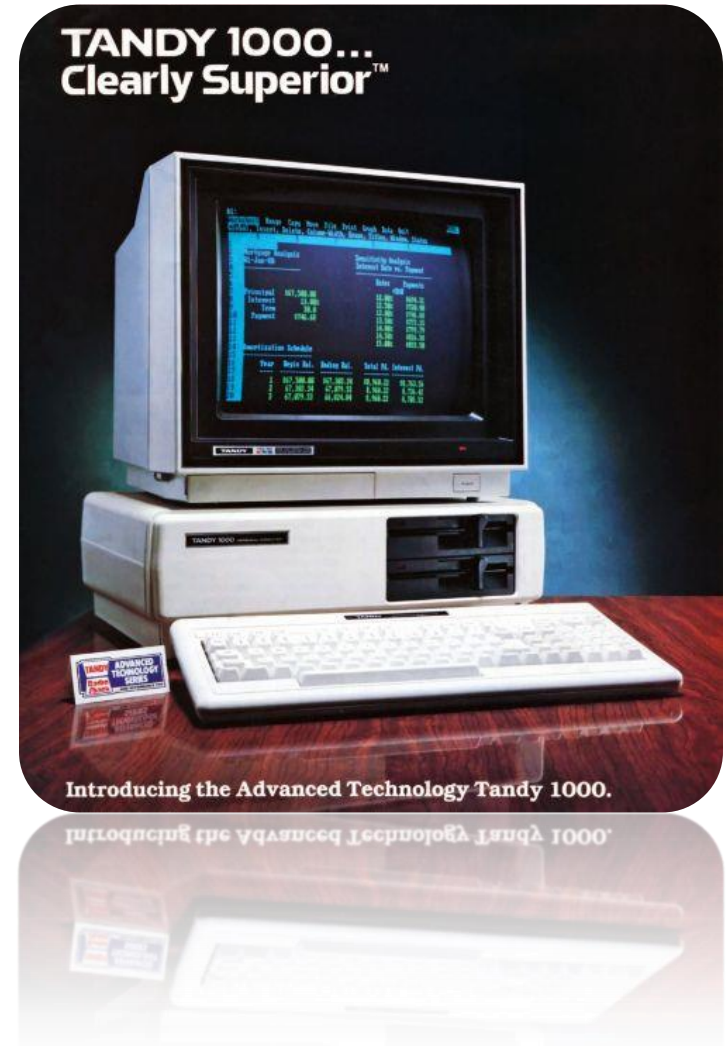

Tandy 1000

- ▶ Competed with PCjr during 1984 Christmas season
 - ▶ Unlike PCjr, sales remained strong after Christmas
- ▶ Additional models followed (EX, SX, HX, TX, RL, SL, TL), all with “Tandy” graphics and sound that were supported into the early 1990s

Tandy + Sierra =
Accelerated growth of PC as a gaming platform



The PCjr Today

PCjr Hacks

- ▶ What happens when you take the XT-IDE BIOS project and adapt it to PCjr's limitations?
- ▶ Answer: **jrIDE**
- ▶ Single sidecar that adds IDE hard drive, 640K RAM, battery-backed clock
- ▶ One of only two sidecars you'll ever need

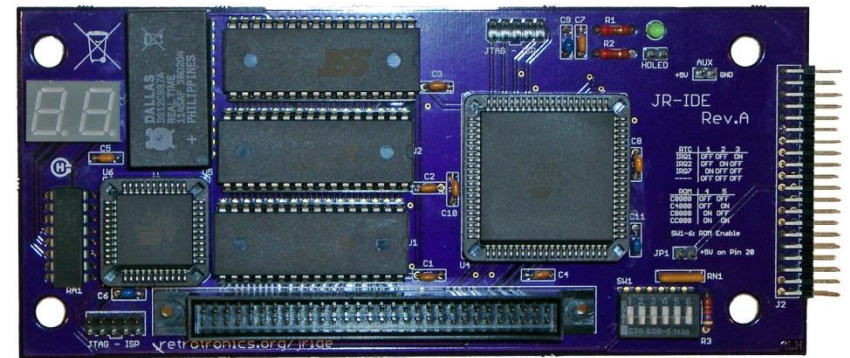
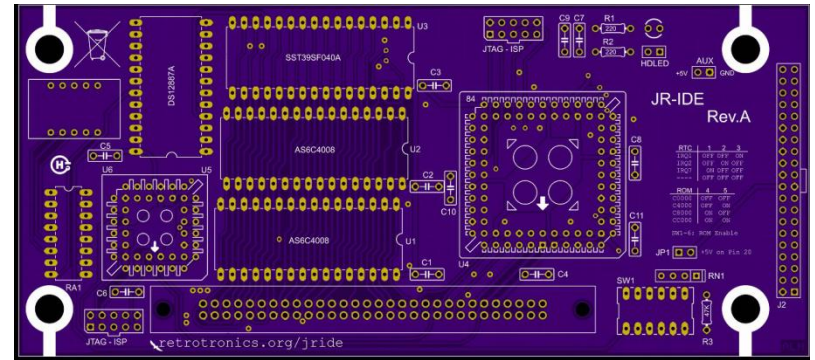

PCjr Hacks

- ▶ Some games implementing “Tandy” graphics assumed fixed video memory locations
- ▶ Incompatible with PCjr
- ▶ Answer: **Tandy 1000 graphics mod**
- ▶ Expands B800 video window from 16K to 32K to be compatible with Tandy

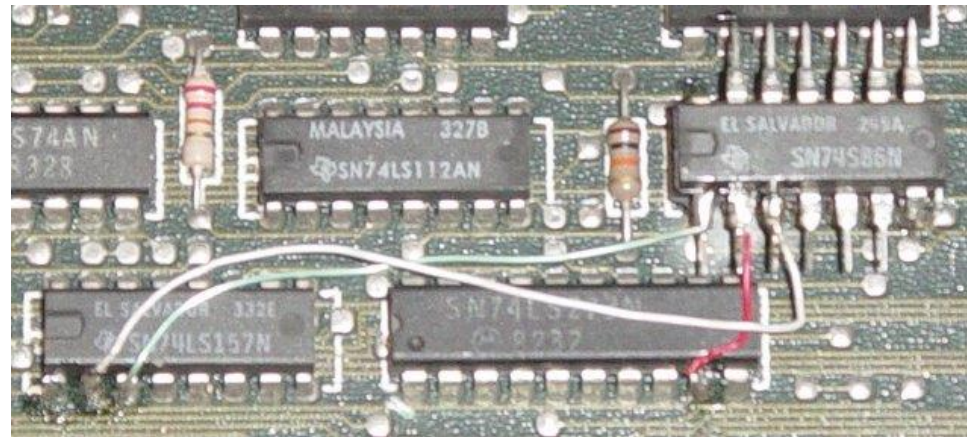
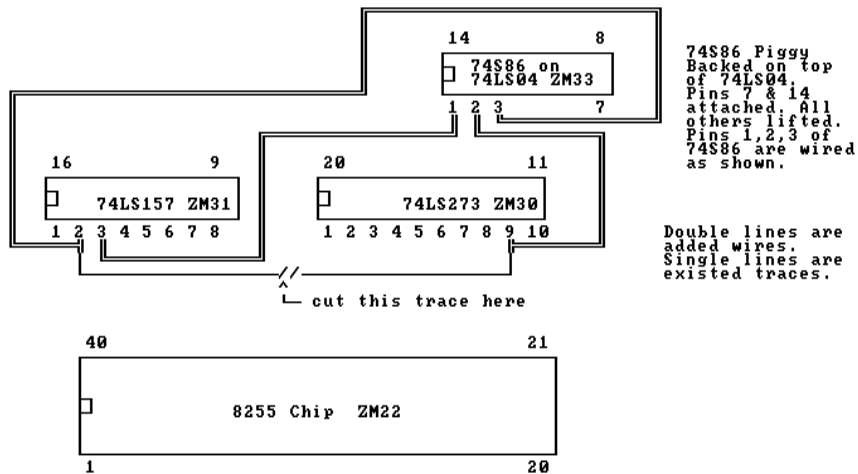

PCjr Hacks: Tandy 1000 Graphics mod

Before Tandy mod



After Tandy Mod



PCjr Homebrews

- ▶ Want to connect your PCjr to the internet?
- ▶ Answer: **mTCP suite**
- ▶ Targeted at PCjr + Xircom PE3 parallel-port adapter
 - ▶ Doesn't require PCjr; runs on any DOS machine with a working packet driver, including SLIP and PPP
- ▶ DHCP, ping, DNS, telnet, netcat, SNTP, curl clone, FTP client, FTP server, IRC client



```
mTCP FtpSrv: Total Connections: 1 Active Sessions: 1
mTCP FtpSrv by M Brutman (mbrutman@gmail.com) (C)opynight 2010-2012
Version: May 30 2012

Opening password file at ftpasswd.txt
Password file looks reasonable.

mTCP FtpSrv version (May 30 2012) starting

Clients: 3, Client file buffer size: 8192, TCP buffer size: 8192
Packets per poll: 1, TCP sockets: 10, Send buffers: 15, Recv buffers: 35
Client session timeout: 182 seconds
Control port: 21, Pasv ports: 2048-3071
Real IP address: 192.168.0.29, Pasv response IP addr: 192.168.0.29

Press [Ctrl-C] to end the server

(0) User ftp signed in from 192.168.0.71:62708 at 2013-03-18 15:08:23
(0) BINARY RETR started for E:\GAMES\SIM\JET\JET.EXE
(0) RETR completed
(0) BINARY RETR started for E:\GAMES\SIM\JET\JET.DEM
(0) RETR completed
(0) BINARY RETR started for E:\GAMES\SIM\JET\README
(0) RETR completed
```

```
<MobyGamer> Silent: go
<Silent700> You planning on coming up this weekend to MKE?
<MobyGamer> Toss-up. Depends on wife's work schedule and my desire (I've been to
every one since inception, seeing same stuff 4 times in a row)
<Silent700> Yeah, I wouldn't expect much variation...
<Silent700> I just go for the weekend away :)
<MobyGamer> Takes me 90 minutes to drive north to get there, so maybe I'll go.
<Silent700> I'll be up Friday afternoon/evening
<MobyGamer> You can look at my 8088 Corruption video on archive.org to get a fee
l for what I look like if you want to say hi. Be prepared to recite your handle
as I have forgotten your real name :-))
<MobyGamer> I only go on Saturdays
<Silent700> No you haven't :)
<MobyGamer> Then I have forgotten which real name maps to your handle
<Silent700> hint: I just posted some free magazines to our list
<MobyGamer> When I check email, I will make the connection! :)
<Silent700> or 'my' list
<DoctorPepper> back
<Brandon> welcome back doctor.
<DoctorPepper> thanks
<DoctorPepper> Had a good time out this morning
-irc- 312 -kBR5-
```



No Hardware Required

- ▶ Can't (or won't!) own a PCjr?
DOSBox to the rescue
- ▶ `mode=pcjr` in conf file
 - ▶ Real joystick or gamepad recommended
 - ▶ `timed=true`
- ▶ Can boot disk images and dumped PCjr cartridge ROMs with `BOOT <imagefile>`



Resources

- ▶ Patron saint of the PCjr: Michael Brutman
 - ▶ Brutman's PCjr pages:
<http://www.brutman.com/PCjr/pcjr.html>
 - ▶ PCjr discussion forums:
<http://www.brutman.com/forums/>
 - ▶ jrIDE:
<http://www.brutman.com/jrIDE/jrIDE.html>
 - ▶ mTCP:
<http://www.brutman.com/mTCP/>
- ▶ Tandy 1000 mod:
<http://vintagemashups.net/2011/12/ibm-pcjr-tandy-1000-graphics-mod/>
- ▶ Vintage Computer discussion forums:
<http://www.vintage-computer.com/vcforum/forum.php>
- ▶ Detailed pricing information for PC, PCjr, Tandy 1000:
<http://nerdlypleasures.blogspot.com/2013/03/ibm-pc-pcjr-vs-tandy-1000-price-wars.html>

Contact Info and Q&A

- ▶ My blog: <http://trixter.oldschool.org/>
- ▶ My email: trixter@oldschool.org
- ▶ Twitter: @mobygamer
- ▶ Any questions?

